



# **User Manual of the Quanta LB4M Series Layer 2, 3, and IPv6 Plus QoS Managed Switch**

## Document History

Revision	Date	Editor	Remark
0.1	6/6/2008	Morpheus Chang	Initial Release.

# CONTENTS

1	Introduction .....	33
1.1	Switch Description .....	33
1.2	Features .....	33
1.3	Front-Panel Components .....	34
1.4	LED Indicators .....	34
1.5	Rear Panel Description .....	34
1.6	Management Options .....	35
1.7	Web-based Management Interface .....	35
1.8	Command Line Console Interface Through the Serial Port or Telnet .....	35
1.9	SNMP-Based Management .....	35
2	Installation and Quick Startup .....	38
2.1	Package Contents .....	38
2.2	Switch Installation .....	38
2.3	Installing the Switch in a Rack .....	39
2.4	Quick Starting the Switch .....	40
2.5	System Information Setup .....	41
2.5.1	Quick Start up Software Version Information .....	41
2.5.2	Quick Start up Physical Port Data .....	41
2.5.3	Quick Start up User Account Management .....	42
2.5.4	Quick Start up IP Address .....	43
2.5.5	Quick Start up Uploading from Switch to Out-of-Band PC (Only XMODEM) .....	44
2.5.6	Quick Start up Downloading from Out-of-Band PC to Switch (Only XMODEM) .....	44
2.5.7	Quick Start up Downloading from TFTP Server .....	45
2.5.8	Quick Start up Factory Defaults .....	45
3	Console and Telnet Administration Interface .....	47
3.1	Local Console Management .....	47
3.2	Set Up your Switch Using Console Access .....	47
3.3	Set Up your Switch Using Telnet Access .....	48
4	Web-Based Management Interface .....	49
4.1	Overview .....	49
4.2	How to log in .....	49
4.3	Web-Based Management Menu .....	50
5	Command Line Interface Structure and Mode-based CLI .....	55

---

5.1	CLI Command Format .....	55
5.2	CLI Mode-based Topology .....	55
6	Switching Commands .....	58
6.1	System Information and Statistics commands .....	58
6.1.1	show arp .....	58
6.1.2	show calendar .....	58
6.1.3	show eventlog .....	59
6.1.4	show running-config .....	60
6.1.5	show sysinfo .....	60
6.1.6	show tech-support .....	61
6.1.7	show hardware .....	61
6.1.8	show version .....	64
6.1.9	show loginsession .....	65
6.2	Device Configuration Commands .....	66
6.2.1	Interface .....	66
6.2.1.1	show interface status .....	66
6.2.1.2	show interface status description .....	67
6.2.1.3	show interface counters .....	67
6.2.1.4	show interface switch .....	73
6.2.1.5	interface .....	74
6.2.1.6	speed-duplex .....	74
6.2.1.7	negotiate .....	75
6.2.1.8	capabilities .....	76
6.2.1.9	storm-control flowcontrol .....	78
6.2.1.10	shutdown .....	79
6.2.1.11	description .....	80
6.2.1.12	mdi .....	80
	<i>Note: The 10-Giga Interface will not provide the following command</i> .....	80
6.2.2	L2 MAC Address and Multicast Forwarding Database Tables .....	81
6.2.2.1	show mac-addr-table .....	81
6.2.2.2	show mac-addr-table count .....	82
6.2.2.3	show mac-addr-table interface .....	82
6.2.2.4	show mac-addr-table vlan .....	83
6.2.2.5	show mac-address-table gmrp .....	84
6.2.2.6	show mac-address-table igmpsnooping .....	85
6.2.2.7	show mac-address-table multicast .....	85

6.2.2.8	show mac-address-table stats .....	86
6.2.2.9	show mac-address-table agetime .....	87
6.2.2.10	mac-address-table aging-time .....	87
6.2.3	VLAN Management.....	88
6.2.3.1	show vlan .....	88
6.2.3.2	show vlan id.....	89
6.2.3.3	show vlan association mac .....	90
6.2.3.4	show vlan association subnet .....	90
6.2.3.5	show protocol group .....	91
6.2.3.6	show interface switchport .....	92
6.2.3.7	vlan database .....	92
6.2.3.8	vlan .....	93
6.2.3.9	vlan name.....	93
6.2.3.10	vlan association mac .....	94
6.2.3.11	vlan association subnet .....	94
6.2.3.12	vlan makestatic.....	95
6.2.3.13	protocol group .....	95
6.2.3.14	switchport acceptable-frame-type .....	96
6.2.3.15	switchport ingress-filtering .....	97
6.2.3.16	switchport native vlan .....	98
6.2.3.17	switchport allowed vlan.....	99
6.2.3.18	switchport tagging.....	101
6.2.3.19	switchport priority.....	102
6.2.3.20	switchport protocol group.....	103
6.2.3.21	switchport forbidden vlan .....	105
6.2.4	Double VLAN commands.....	106
6.2.4.1	show dvlan-tunnel/ dot1q-tunnel.....	106
6.2.4.2	switchport dvlan-tunnel/ dot1q-tunnel ethertype.....	106
6.2.4.3	switchport dvlan-tunnel/ dot1q-tunnel .....	107
6.2.5	GVRP and Bridge Extension .....	108
6.2.5.1	show bridge-ext.....	108
6.2.5.2	show gvrp configuration.....	108
6.2.5.3	show gmrp configuration.....	109
6.2.5.4	show garp configuration.....	110
6.2.5.5	bridge-ext gvrp .....	111
6.2.5.6	bridge-ext gmrp .....	111

---

6.2.5.7	switchport gvrp .....	112
6.2.5.8	switchport gmrp .....	113
6.2.5.9	garp timer .....	114
6.2.6	IGMP Snooping .....	118
6.2.6.1	Show Commands .....	118
6.2.6.2	Configuration Commands .....	121
6.2.7	IGMP Snooping Querier .....	130
6.2.7.1	Show Commands .....	130
6.2.7.2	Configuration Commands .....	132
6.2.8	MLD Snooping .....	135
6.2.8.1	Show Commands .....	136
6.2.8.2	Configuration Commands .....	140
6.2.9	MLD Snooping Querier .....	146
6.2.9.1	Show Commands .....	146
6.2.9.2	Configuration Commands .....	148
6.2.10	Port Channel .....	150
6.2.10.1	show port-channel .....	151
6.2.10.2	port-channel .....	152
6.2.10.3	port-channel adminmode all .....	153
6.2.10.4	staticcapability .....	153
6.2.10.5	port-channel linktrap .....	154
6.2.10.6	port-channel load-balance .....	154
6.2.10.7	port-channel name .....	156
6.2.10.8	adminmode .....	156
6.2.10.9	lacp .....	157
6.2.10.10	channel-group .....	158
6.2.10.11	delete-channel-group .....	159
6.2.11	Storm Control .....	159
6.2.11.1	show storm-control .....	160
6.2.11.2	storm-control broadcast .....	161
6.2.11.3	storm-control multicast .....	162
6.2.11.4	storm-control unicast .....	163
6.2.11.5	switchport broadcast packet-rate .....	164
6.2.11.6	switchport multicast packet-rate .....	165
6.2.11.7	switchport unicast packet-rate .....	166
6.2.12	L2 Priority .....	168

---

6.2.12.1	show queue cos-map .....	168
6.2.12.2	queue cos-map.....	168
6.2.13	Port Mirror.....	169
6.2.13.1	show port-monitor session.....	169
6.2.13.2	port-monitor session .....	170
6.2.13.3	port-monitor session mode .....	171
6.3	Management Commands.....	171
6.3.1	Network Commands.....	171
6.3.1.1	show ip interface .....	171
6.3.1.2	show ip filter .....	172
6.3.1.3	mtu .....	173
6.3.1.4	interface vlan .....	173
6.3.1.5	ip address.....	174
6.3.1.6	ip default-gateway .....	174
6.3.1.7	ip address protocol .....	175
6.3.1.8	ip filter.....	175
6.3.2	Serial Interface Commands.....	176
6.3.2.1	show line console .....	176
6.3.2.2	line console .....	177
6.3.2.3	baudrate .....	178
6.3.2.4	exec-timeout.....	178
6.3.2.5	password-threshold .....	179
6.3.2.6	silent-time.....	179
6.3.2.7	terminal length.....	180
6.3.3	Telnet Session Commands.....	180
6.3.3.1	telnet .....	180
6.3.3.2	show line vty.....	181
6.3.3.3	line vty .....	181
6.3.3.4	exec-timeout.....	182
6.3.3.5	password-threshold .....	183
6.3.3.6	terminal length.....	183
6.3.3.7	maxsessions.....	183
6.3.3.8	server enable.....	184
6.3.3.9	sessions .....	184
6.3.3.10	telnet sessions.....	185
6.3.3.11	telnet maxsessions .....	186

---

6.3.3.12	telnet exec-timeout .....	186
6.3.3.13	show telnet .....	187
6.3.4	SNMP Server Commands .....	188
6.3.4.1	show snmp .....	188
6.3.4.2	show trapflags .....	188
6.3.4.3	snmp-server sysname .....	189
6.3.4.4	snmp-server location .....	190
6.3.4.5	snmp-server contact .....	190
6.3.4.6	snmp-server community .....	191
6.3.4.7	snmp-server host.....	193
6.3.4.8	snmp-server enable traps .....	194
6.3.5	SNMP Trap Commands .....	199
6.3.5.1	show snmptrap .....	199
6.3.5.2	snmptrap snmpversion .....	199
6.3.5.3	snmptrap link-status .....	200
6.3.5.4	snmptrap <name> <ipaddr> <snmpversion> .....	201
6.3.5.5	snmptrap ipaddr.....	202
6.3.5.6	snmptrap mode .....	202
6.3.6	HTTP commands .....	203
6.3.6.1	show ip http .....	203
6.3.6.2	ip javamode.....	204
6.3.6.3	ip http port .....	204
6.3.6.4	ip http server.....	205
6.3.6.5	ip http secure-port.....	205
6.3.6.6	ip http secure-server .....	206
6.3.6.7	ip http secure-protocol .....	206
6.3.7	Secure Shell (SSH) Commands.....	207
6.3.7.1	show ip ssh.....	207
6.3.7.2	ip ssh.....	208
6.3.7.3	ip ssh protocol .....	208
6.3.7.4	ip ssh maxsessions .....	209
6.3.7.5	ip ssh timeout .....	209
6.3.7.6	http session hard-timeout .....	210
6.3.7.7	http session hard-timeout .....	210
6.3.7.8	http session soft-timeout.....	211
6.3.7.9	http secure-session soft-timeout.....	211



---

6.3.7.10	Set max sessions .....	212
6.3.7.11	Set max secure-sessions.....	212
6.3.7.12	Set ip http java.....	213
6.3.8	DHCP Client Commands.....	213
6.3.8.1	ip dhcp restart.....	213
6.3.8.2	ip dhcp client-identifier .....	214
6.3.9	DHCP Relay Commands.....	214
6.3.9.1	show bootpdhcprelay.....	214
6.3.9.2	bootpdhcprelay maxhopcount.....	215
6.3.9.3	bootpdhcprelay serverip .....	216
6.3.10	sFlow Commands .....	216
6.3.10.1	show sFlow information .....	216
6.3.10.2	set sFlow sampling rate.....	217
6.3.10.3	set sFlow maximum header size.....	218
6.3.10.4	set sFlow maximum datagram size.....	218
6.3.10.5	set sFlow collector address .....	218
6.3.10.6	set sFlow collector port.....	219
6.3.10.7	set sFlow interval.....	219
6.3.11	Service Port Commands .....	220
6.3.11.1	show serviceport .....	220
6.3.11.2	show serviceport ndp.....	220
6.3.11.3	serviceport ip.....	221
6.3.11.4	serviceport protocol .....	222
6.4	Spanning Tree Commands.....	223
6.4.1	Show Commands.....	223
6.4.1.1	show spanning-tree .....	223
6.4.1.2	show spanning-tree interface.....	224
6.4.1.3	show spanning-tree vlan.....	225
6.4.1.4	show spanning-tree mst.....	225
6.4.1.5	show spanning-tree summary.....	229
6.4.1.6	show spanning-tree brief .....	229
6.4.2	Configuration Commands .....	230
6.4.2.1	spanning-tree .....	230
6.4.2.2	spanning-tree protocol-migration .....	230
6.4.2.3	spanning-tree configuration .....	231
6.4.2.4	spanning-tree mode.....	232

---

6.4.2.5	spanning-tree forward-time.....	233
6.4.2.6	spanning-tree hello-time.....	233
6.4.2.7	spanning-tree max-age.....	234
6.4.2.8	spanning-tree max-hops.....	235
6.4.2.9	spanning-tree mst.....	235
6.4.2.10	spanning-tree port mode.....	239
6.4.2.11	spanning-tree edgeport.....	240
6.5	System Log Management Commands.....	241
6.5.1	Show Commands.....	241
6.5.1.1	show logging.....	241
6.5.2	show logging buffered.....	241
6.5.3	show logging traplog.....	242
6.5.3.1	show logging hosts.....	243
6.5.4	Configuration Commands.....	243
6.5.4.1	logging buffered.....	243
6.5.4.2	logging console.....	244
6.5.4.3	logging host.....	245
6.5.4.4	logging syslog.....	246
6.5.4.5	clear logging buffered.....	247
6.6	Script Management Commands.....	248
6.6.1	script apply.....	248
6.6.2	script delete.....	248
6.6.3	script list.....	249
6.6.4	script show.....	249
6.7	User Account Management Commands.....	250
6.7.1	Show Commands.....	250
6.7.1.1	show users.....	250
6.7.1.2	show users account information.....	251
6.7.2	Configuration Commands.....	251
6.7.2.1	username.....	251
6.7.2.2	Unlock a locked user account.....	252
6.7.2.3	Set encrypted the password.....	252
6.7.2.4	username snmpv3 authentication.....	253
6.7.2.5	username snmpv3 encryption.....	254
6.7.2.6	Set the password aging.....	254
6.7.2.7	Set the password history.....	255

---

6.7.2.8	Set the password lock-out count.....	255
6.7.2.9	Set the minimum password length.....	256
6.8	Security Commands.....	256
6.8.1	Show Commands.....	256
6.8.1.1	show users authentication .....	256
6.8.1.2	show authentication.....	257
6.8.1.3	show authentication users .....	257
6.8.1.4	show dot1x .....	258
6.8.1.5	show dot1x detail.....	258
6.8.1.6	show dot1x statistics.....	259
6.8.1.7	show dot1x summary.....	260
6.8.1.8	show dot1x users.....	261
6.8.1.9	show radius-servers .....	262
6.8.1.10	show radius .....	262
6.8.1.11	show radius accounting .....	263
6.8.1.12	show radius statistics.....	264
6.8.1.13	show tacacs.....	265
6.8.1.14	show port-security .....	266
6.8.2	Configuration Commands .....	268
6.8.2.1	authentication login.....	268
6.8.2.2	username defaultlogin .....	269
6.8.2.3	username login.....	270
6.8.3	Dot1x Configuration Commands .....	270
6.8.3.1	dot1x initialize.....	270
6.8.3.2	dot1x default-login .....	271
6.8.3.3	dot1x login .....	271
6.8.3.4	dot1x system-auth-control .....	272
6.8.3.5	dot1x user .....	272
6.8.3.6	dot1x port-control.....	273
6.8.3.7	dot1x host-mode.....	274
6.8.3.8	dot1x max-req .....	275
6.8.3.9	dot1x max-user.....	275
6.8.3.10	dot1x re-authentication .....	276
6.8.3.11	dot1x re-reauthenticate.....	276
6.8.3.12	dot1x timeout.....	277
6.8.3.13	dot1x guest vlan .....	278

---

6.8.3.14	dot1x guest-vlan .....	279
6.8.3.15	dot1x timeout guest-vlan-period.....	279
6.8.4	Radius Configuration Commands.....	280
6.8.4.1	radius accounting mode.....	280
6.8.4.2	radius server attribute 4.....	280
6.8.4.3	radius-server dead-time.....	281
6.8.4.4	radius-server host.....	281
6.8.4.5	radius-sever key .....	282
6.8.4.6	radius-server retransmit.....	283
6.8.4.7	radius-server timeout.....	284
6.8.4.8	radius-server msgauth.....	284
6.8.4.9	radius-server primary.....	285
6.8.5	TACACS+ Configuration Commands .....	285
6.8.5.1	tacacs host .....	285
6.8.5.2	tacacs key .....	286
6.8.5.3	tacacs timeout .....	287
6.8.6	Port Security Configuration Commands .....	288
6.8.6.1	port-security.....	288
6.8.6.2	port-security max-dynamic.....	289
6.8.6.3	port-security max-static.....	290
6.8.6.4	port-security mac-address .....	290
6.8.6.5	port-security mac-address move.....	291
6.8.6.6	port-security violation shutdown.....	291
6.9	CDP (Cisco Discovery Protocol) Commands .....	292
6.9.1	Show Commands.....	292
6.9.1.1	show cdp .....	292
6.9.1.2	show cdp neighbors.....	292
6.9.1.3	show cdp traffic.....	293
6.9.2	Configuration Commands .....	294
6.9.2.1	cdp .....	294
6.9.2.2	cdp run .....	294
6.9.2.3	cdp timer .....	295
6.9.2.4	cdp holdtime .....	296
6.10	SNTP (Simple Network Time Protocol) Commands .....	296
6.10.1	Show Commands.....	296
6.10.1.1	show sntp .....	296

---

6.10.2	Configuration Commands .....	298
6.10.2.1	sntp broadcast client poll-interval.....	298
6.10.2.2	sntp client mode .....	299
6.10.2.3	sntp client port.....	299
6.10.2.4	sntp unicast client poll-interval.....	300
6.10.2.5	sntp unicast client poll-timeout.....	300
6.10.2.6	sntp unicast client poll-retry .....	301
6.10.2.7	sntp server.....	302
6.10.2.8	sntp clock timezone .....	302
6.11	MAC-Based Voice VLAN Commands .....	303
6.11.1	Show Commands.....	303
6.11.1.1	show voice-vlan.....	303
6.11.1.2	show voice vlan .....	304
6.11.2	Configuration Commands .....	304
6.11.2.1	voice-vlan .....	304
6.11.2.2	voice-vlan vlan.....	305
6.11.2.3	voice-vlan mac .....	305
6.11.2.4	voice vlan .....	306
6.11.2.5	voice vlan (Interface Config) .....	306
6.11.2.6	voice vlan data priority.....	307
6.12	LLDP (Link Layer Discovery Protocol) Commands.....	308
6.12.1	Show Commands.....	308
6.12.1.1	show lldp .....	308
6.12.1.2	show lldp interface.....	308
6.12.1.3	show lldp statistics.....	309
6.12.1.4	show lldp remote-device .....	310
6.12.1.5	show lldp remote-device detail.....	310
6.12.1.6	show lldp local-device.....	311
6.12.1.7	show lldp local-device detail .....	312
6.12.1.8	show lldp med .....	313
6.12.1.9	show lldp med interface.....	313
6.12.1.10	show lldp med local-device detail.....	314
6.12.1.11	show lldp med remote-device .....	315
6.12.1.12	show lldp med remote-device detail.....	316
6.12.2	Configuration Commands .....	317
6.12.2.1	lldp notification.....	317

---

6.12.2.2	lldp notification-interval .....	318
6.12.2.3	lldp receive .....	319
6.12.2.4	lldp transmit .....	319
6.12.2.5	lldp transmit-mgmt .....	319
6.12.2.6	lldp transmit-tlv .....	320
6.12.2.7	lldp timers .....	321
6.12.2.8	lldp med .....	321
6.12.2.9	lldp med confignotification .....	322
6.12.2.10	lldp med transmit-tlv .....	322
6.12.2.11	lldp med all .....	323
6.12.2.12	lldp med confignotification all .....	323
6.12.2.13	lldp med faststartrepeatcount .....	324
6.12.2.14	lldp med transmit-tlv all .....	324
6.13	Denial Of Service Commands .....	325
6.13.1	Show Commands .....	325
6.13.1.1	show dos-control .....	325
6.13.2	Configuration Commands .....	326
6.13.2.1	dos-control sipdip .....	326
6.13.2.2	dos-control firstfrag .....	326
6.13.2.3	dos-control tcpfrag .....	327
6.13.2.4	dos-control tcpflag .....	327
6.13.2.5	dos-control l4port .....	328
6.13.2.6	dos-control icmp .....	328
6.13.2.7	dos-control icmpv6 .....	329
6.14	VTP (VLAN Trunking Protocol) Commands .....	330
6.14.1	Show Commands .....	330
6.14.1.1	show vtp counters .....	330
6.14.1.2	show vtp password .....	330
6.14.1.3	show vtp status .....	331
6.14.1.4	show vtp trunkport .....	332
6.14.2	Configuration Commands .....	332
6.14.2.1	vtp .....	332
6.14.2.2	vtp domain .....	333
6.14.2.3	vtp mode .....	333
6.14.2.4	vtp password .....	334
6.14.2.5	vtp pruning .....	334

---

6.14.2.6	vtp trunkport .....	335
6.15	Protected Ports Commands .....	336
6.15.1	Show Commands.....	336
6.15.1.1	show switchport protected .....	336
6.15.2	Configuration Commands .....	336
6.15.2.1	switchport protected .....	336
6.16	Static MAC Filtering Commands .....	338
6.16.1	Show Commands.....	338
6.16.1.1	show mac-address-table static .....	338
6.16.2	Configuration Commands .....	338
6.16.2.1	macfilter.....	338
6.16.2.2	macfilter addsrc.....	339
6.16.2.3	macfilter addsrc all.....	340
6.17	System Utilities .....	340
6.17.1	clear.....	340
6.17.1.1	clear arp .....	340
6.17.1.2	clear traplog.....	341
6.17.1.3	clear eventlog .....	341
6.17.1.4	clear logging buffered .....	341
6.17.1.5	clear config.....	342
6.17.1.6	clear pass.....	342
6.17.1.7	clear counters.....	343
6.17.1.8	clear dns.....	343
6.17.1.9	clear cdp.....	344
6.17.1.10	clear vlan .....	344
6.17.1.11	clear igmp snooping .....	345
6.17.1.12	clear port-channel.....	345
6.17.1.13	clear ip filter .....	345
6.17.1.14	clear dot1x statistics .....	346
6.17.1.15	clear radius statistics .....	346
6.17.1.16	clear domain-list .....	347
6.17.1.17	clear hosts .....	347
6.17.1.18	clear port-security dynamic address .....	348
6.17.1.19	clear ip arp-cache.....	348
6.17.1.20	clear lldp statistics .....	349
6.17.1.21	clear lldp remote-data.....	349

---

6.17.1.22	enable passwd .....	350
6.17.1.23	clear ipv6 neighbors .....	350
6.17.1.24	clear ipv6 statistics .....	350
6.17.1.25	clear ipv6 dhcp .....	351
6.17.2	copy .....	352
6.17.3	delete .....	354
6.17.4	dir .....	355
6.17.5	whichboot .....	355
6.17.6	boot-system .....	356
6.17.7	ping .....	356
6.17.7.1	ping <host> .....	356
6.17.7.2	ping ipv6 <ipv6-address> .....	357
6.17.7.3	ping ipv6 interface .....	358
6.17.8	traceroute .....	359
6.17.8.1	traceroute .....	359
6.17.8.2	traceroute ipv6 .....	360
6.17.9	logging cli-command .....	360
6.17.10	calendar set .....	361
6.17.11	reload .....	361
6.17.12	configure .....	362
6.17.13	disconnect .....	362
6.17.14	hostname .....	363
6.17.15	quit 363	
6.18	Differentiated Service Command .....	364
6.18.1	General Commands .....	365
6.18.1.1	diffserv .....	365
6.18.1.2	no diffserv .....	365
6.18.2	Class Commands .....	366
6.18.2.1	class-map .....	366
6.18.2.2	no class-map .....	367
6.18.2.3	class-map rename .....	367
6.18.2.4	match any .....	368
6.18.2.5	match class-map .....	368
6.18.2.6	no match class-map .....	369
6.18.2.7	match cos .....	369
6.18.2.8	match destination-address mac .....	370



---

6.18.2.9	match dstip .....	370
6.18.2.10	match dstl4port .....	371
6.18.2.11	match ethertype .....	372
6.18.2.12	match ip dscp .....	372
6.18.2.13	match ip precedence .....	373
6.18.2.14	match ip tos .....	373
6.18.2.15	match protocol .....	374
6.18.2.16	match secondary-cos .....	375
6.18.2.17	match secondary-vlan .....	375
6.18.2.18	match source-address mac .....	376
6.18.2.19	match srcip .....	376
6.18.2.20	match srcl4port .....	377
6.18.2.21	match vlan .....	377
6.18.3	Policy Commands .....	378
6.18.3.1	assign-queue .....	378
6.18.3.2	drop .....	379
6.18.3.3	mirror .....	379
6.18.3.4	redirect .....	380
6.18.3.5	conform-color .....	380
6.18.3.6	mark cos .....	381
6.18.3.7	class .....	381
6.18.3.8	no class .....	382
6.18.3.9	mark ip-dscp .....	382
6.18.3.10	mark ip-precedence .....	383
6.18.3.11	police-simple .....	383
6.18.3.12	policy-map .....	384
6.18.3.13	policy-map rename .....	384
6.18.4	Service Commands .....	385
6.18.4.1	service-policy .....	385
6.18.4.2	no service-policy .....	386
6.18.5	Show Commands .....	386
6.18.5.1	show class-map .....	387
6.18.5.2	show diffserv .....	388
6.18.5.3	show diffserv service .....	389
6.18.5.4	show diffserv service brief .....	389
6.18.5.5	show policy-map .....	390

6.18.5.6	show policy-map interface .....	391
6.18.5.7	show service-policy .....	393
6.19	ACL Command .....	393
6.19.1	Show Commands.....	394
6.19.1.1	show mac access-lists name .....	394
6.19.1.2	show mac access-lists .....	394
6.19.1.3	show ip access-lists.....	395
6.19.1.4	show access-lists interface .....	396
6.19.2	Configuration Commands .....	397
6.19.2.1	mac access-list extended .....	397
6.19.2.2	mac access-list extended rename .....	397
6.19.2.3	mac access-group in .....	398
6.19.2.4	mac access-list.....	399
6.19.2.5	access-list .....	399
6.19.2.6	no access-list.....	400
6.19.2.7	ip access-group .....	401
6.20	IPv6 ACL Command .....	401
6.20.1	Show Commands.....	401
6.20.1.1	show ipv6 access-lists .....	401
6.20.2	Configuration Commands .....	402
6.20.2.1	ipv6 access-list .....	402
6.20.2.2	ipv6 access-list rename .....	403
6.20.2.3	{deny   permit} (IPv6).....	403
6.20.2.4	ipv6 traffic-filter .....	404
6.20.2.5	ipv6 traffic-filter .....	405
6.20.2.6	mac access-group .....	405
6.21	CoS (Class of Service) Command .....	406
6.21.1	Show Commands.....	406
6.21.1.1	show queue cos-map .....	406
6.21.1.2	show queue ip-dscp-mapping.....	407
6.21.1.3	show queue trust.....	408
6.21.1.4	show queue cos-queue .....	408
6.21.2	Configuration Commands .....	409
6.21.2.1	queue cos-map.....	409
6.21.2.2	queue trust .....	410
6.21.2.3	queue cos-queue min-bandwidth.....	411

---

6.21.2.4	queue cos-queue strict .....	412
6.21.2.5	queue cos-queue traffic-shape .....	413
7	Routing Commands .....	415
7.1	Address Resolution Protocol (ARP) Commands .....	415
7.1.1	Show Commands.....	415
7.1.1.1	show ip arp .....	415
7.1.1.2	show ip arp brief .....	416
7.1.1.3	show ip arp static.....	416
7.1.2	Configuration Commands .....	417
7.1.2.1	arp.....	417
7.1.2.2	ip proxy-arp .....	417
7.1.2.3	ip local-proxy-arp.....	418
7.1.2.4	arp cachesize .....	418
7.1.2.5	arp dynamicrenew .....	419
7.1.2.6	arp purge.....	419
7.1.2.7	arp resptime .....	420
7.1.2.8	arp retries .....	420
7.1.2.9	arp timeout .....	420
7.1.2.10	clear ip arp-cache.....	421
7.2	IP Routing Commands.....	421
7.2.1	Show Commands.....	421
7.2.1.1	show ip brief .....	421
7.2.1.2	show ip interface port .....	422
7.2.1.3	show ip interface brief.....	422
7.2.1.4	show ip route .....	423
7.2.1.5	show ip route bestroutes.....	424
7.2.1.6	show ip route entry .....	425
7.2.1.7	show ip route connected.....	425
7.2.1.8	show ip route ospf .....	426
7.2.1.9	show ip route rip .....	427
7.2.1.10	show ip route static.....	428
7.2.1.11	show ip route summary .....	428
7.2.1.12	show ip route precedence.....	429
7.2.1.13	show ip traffic .....	429
7.2.2	Configuration Commands .....	430
7.2.2.1	routing .....	430

---

7.2.2.2	ip routing .....	430
7.2.2.3	ip address.....	431
7.2.2.4	ip route .....	431
7.2.2.5	ip route default-next-hop.....	432
7.2.2.6	ip route precedence.....	432
7.2.2.7	ip forwarding.....	433
7.2.2.8	ip directed-broadcast .....	433
7.2.2.9	ip mtu .....	433
7.2.2.10	encapsulation .....	434
7.3	Open Shortest Path First (OSPF) Commands.....	434
7.3.1	Show Commands.....	434
7.3.1.1	show ip ospf .....	435
7.3.1.2	show ip ospf area .....	436
7.3.1.3	show ip ospf abr .....	436
7.3.1.4	show ip ospf asbr.....	437
7.3.1.5	show ip ospf database .....	437
7.3.1.6	show ip ospf database database-summary.....	438
7.3.1.7	show ip ospf interface.....	439
7.3.1.8	show ip ospf interface brief .....	440
7.3.1.9	show ip ospf interface stats.....	441
7.3.1.10	show ip ospf neighbor.....	441
7.3.1.11	show ip ospf neighbor brief.....	444
7.3.1.12	show ip ospf range .....	444
7.3.1.13	show ip ospf statistics .....	445
7.3.1.14	show ip ospf stub table .....	446
7.3.1.15	show ip ospf virtual-link.....	446
7.3.1.16	show ip ospf virtual-link brief.....	447
7.3.2	Configuration Commands .....	448
7.3.2.1	enable ospf.....	448
7.3.2.2	no area .....	448
7.3.2.3	ip ospf.....	449
7.3.2.4	1583compatibility.....	449
7.3.2.5	area default-cost.....	449
7.3.2.6	area nssa .....	450
7.3.2.7	area nssa default-info-originate .....	450
7.3.2.8	area nssa no-redistribute .....	451

---

7.3.2.9	area nssa no-summary .....	451
7.3.2.10	area nssa translator-role .....	452
7.3.2.11	area nssa translator-stab-intv .....	452
7.3.2.12	area range .....	453
7.3.2.13	area stub .....	454
7.3.2.14	area stub summarylsa .....	454
7.3.2.15	area virtual-link authentication .....	455
7.3.2.16	area virtual-link dead-interval.....	455
7.3.2.17	area virtual-link hello-interval .....	456
7.3.2.18	area virtual-link retransmit-interval.....	457
7.3.2.19	area virtual-link transmit-delay .....	457
7.3.2.20	default-information originate .....	458
7.3.2.21	default-metric.....	458
7.3.2.22	distance ospf .....	459
7.3.2.23	distribute-list out .....	460
7.3.2.24	exit-overflow-interval.....	460
7.3.2.25	external-lsdb-limit .....	461
7.3.2.26	ip ospf areaid.....	461
7.3.2.27	ip ospf authentication.....	462
7.3.2.28	ip ospf cost .....	463
7.3.2.29	ip ospf dead-interval .....	463
7.3.2.30	ip ospf hello -interval.....	464
7.3.2.31	ip ospf priority .....	464
7.3.2.32	ip ospf retransmit-interval .....	465
7.3.2.33	ip ospf transmit-delay .....	466
7.3.2.34	ip ospf mtu-ignore.....	466
7.3.2.35	router-id.....	467
7.3.2.36	redistribute.....	467
7.3.2.37	maximum-paths.....	468
7.3.2.38	timers spf.....	469
7.4	Bootp/DHCP Relay Commands .....	469
7.4.1	show bootpdhcprelay .....	469
7.4.2	bootpdhcprelay cidoptmode .....	470
7.4.3	bootpdhcprelay enable.....	470
7.4.4	bootpdhcprelay maxhopcount .....	470
7.4.5	bootpdhcprelay minwaittime.....	471

---

7.4.6	bootpdhcprelay serverip.....	471
7.5	Domain Name Server Relay Commands .....	472
7.5.1	Show Commands.....	472
7.5.1.1	show hosts .....	472
7.5.1.2	show dns .....	472
7.5.1.3	show dns cache.....	473
7.5.2	Configuration Commands .....	474
7.5.2.1	ip hosts.....	474
7.5.2.2	clear hosts.....	474
7.5.2.3	ip domain-name.....	475
7.5.2.4	ip domain-list .....	475
7.5.2.5	ip name-server .....	476
7.5.2.6	ip domain-lookup .....	476
7.5.2.7	clear domain-list .....	477
7.5.2.8	clear dns.....	477
7.5.2.9	clear dns cache .....	478
7.5.2.10	clear dns counter.....	478
7.6	Routing Information Protocol (RIP) Commands .....	479
7.6.1	Show Commands.....	479
7.6.1.1	show ip rip .....	479
7.6.1.2	show ip rip interface.....	480
7.6.1.3	show ip rip interface brief.....	481
7.6.2	Configuration Commands .....	481
7.6.2.1	enable rip .....	481
7.6.2.2	ip rip .....	482
7.6.2.3	auto-summary .....	482
7.6.2.4	default-information originate .....	483
7.6.2.5	default-metric.....	483
7.6.2.6	distance rip .....	484
7.6.2.7	hostrouteaccept.....	484
7.6.2.8	split-horizon .....	485
7.6.2.9	distribute-list .....	485
7.6.2.10	redistribute.....	486
7.6.2.11	ip rip authentication .....	487
7.6.2.12	ip rip receive version.....	487
7.6.2.13	ip rip send version .....	488

---

7.7	Router Discovery Protocol Commands .....	489
7.7.1	show ip irdp.....	489
7.7.2	ip irdp.....	489
7.7.3	ip irdp broadcast .....	490
7.7.4	ip irdp holdtime.....	490
7.7.5	ip irdp maxadvertinterval .....	491
7.7.6	ip irdp minadvertinterval .....	491
7.7.7	ip irdp preference .....	492
7.8	VLAN Routing Commands.....	492
7.8.1	show ip vlan .....	492
7.8.2	vlan routing .....	493
7.9	Virtual Router Redundancy Protocol (VRRP) Commands.....	493
7.9.1	Show Commands.....	493
7.9.1.1	show ip vrrp.....	493
7.9.1.2	show ip vrrp brief .....	494
7.9.1.3	show ip vrrp interface .....	495
7.9.1.4	show ip vrrp interface stats .....	495
7.9.2	Configuration Commands .....	496
7.9.2.1	ip vrrp .....	496
7.9.2.2	ip vrrp ip .....	497
7.9.2.3	ip vrrp mode .....	498
7.9.2.4	ip vrrp authentication .....	498
7.9.2.5	ip vrrp preempt .....	499
7.9.2.6	ip vrrp priority.....	499
7.9.2.7	ip vrrp timers advertise .....	500
7.10	DHCP Filtering Commands.....	500
7.10.1	Show Commands.....	501
7.10.1.1	show ip dhcp filtering .....	501
7.10.2	Configuration Commands .....	501
7.10.2.1	ip dhcp filtering .....	501
7.10.2.2	ip dhcp filtering trust .....	502
8	IP Multicast Commands .....	503
8.1	Distance Vector Multicast Routing Protocol (DVMRP) Commands.....	503
8.1.1	Show Commands.....	503
8.1.1.1	show ip dvmrp .....	503
8.1.1.2	show ip dvmrp interface.....	503

---

8.1.1.3	show ip dvmrp neighbor.....	504
8.1.1.4	show ip dvmrp nexthop.....	505
8.1.1.5	show ip dvmrp prune .....	505
8.1.1.6	show ip dvmrp route .....	506
8.1.2	Configuration Commands .....	506
8.1.2.1	ip dvmrp .....	506
8.1.2.2	ip dvmrp metric.....	507
8.2	Internet Group Management Protocol (IGMP) Commands.....	508
8.2.1	Show Commands.....	508
8.2.1.1	show ip igmp .....	508
8.2.1.2	show ip igmp groups.....	509
8.2.1.3	show ip igmp interface.....	510
8.2.1.4	show ip igmp interface membership .....	511
8.2.1.5	show ip igmp interface stats.....	512
8.2.2	Configuration Commands .....	512
8.2.2.1	ip igmp.....	512
8.2.2.2	ip igmp version .....	513
8.2.2.3	ip igmp last-member-query-count .....	514
8.2.2.4	ip igmp last-member-query-interval .....	514
8.2.2.5	ip igmp query-interval .....	515
8.2.2.6	ip igmp query-max-response-time .....	515
8.2.2.7	ip igmp robustness .....	516
8.2.2.8	ip igmp startup-query-count .....	516
8.2.2.9	ip igmp startup-query-interval .....	517
8.3	Multicast Commands .....	517
8.3.1	Show Commands.....	517
8.3.1.1	show ip mcast.....	517
8.3.1.2	show ip mcast boundary .....	518
8.3.1.3	show ip mcast interface .....	519
8.3.1.4	show ip mcast mroute.....	519
8.3.1.5	show mrimfo .....	522
8.3.1.6	show mstat .....	523
8.3.1.7	show mtrace .....	524
8.3.2	Configuration Commands .....	524
8.3.2.1	ip multicast .....	524
8.3.2.2	ip multicast staticroute .....	525



8.3.2.3	no ip mcast mroute .....	526
8.3.2.4	ip mcast boundary .....	527
8.3.2.5	ip multicast ttl-threshold .....	527
8.3.2.6	mrinfo .....	528
8.3.2.7	mstat .....	528
8.3.2.8	mtrace .....	529
8.3.2.9	disable ip multicast mdebug mtrace .....	530
8.4	Protocol Independent Multicast – Dense Mode (PIM-DM) Commands .....	530
8.4.1	Show Commands .....	530
8.4.1.1	show ip pimdm .....	530
8.4.1.2	show ip pimdm interface .....	531
8.4.1.3	show ip pimdm interface stats .....	532
8.4.1.4	show ip pimdm neighbor .....	532
8.4.2	Configuration Commands .....	533
8.4.2.1	ip pimdm .....	533
8.4.2.2	ip pimdm mode .....	533
8.4.2.3	ip pimdm query-interval .....	534
8.5	Protocol Independent Multicast – Sparse Mode (PIM-SM) Commands .....	534
8.5.1	Show Commands .....	535
8.5.1.1	show ip pimsm .....	535
8.5.1.2	show ip pimsm componenttable .....	535
8.5.1.3	show ip pimsm interface .....	536
8.5.1.4	show ip pimsm interface stats .....	537
8.5.1.5	show ip pimsm neighbor .....	537
8.5.1.6	show ip pimsm rp .....	538
8.5.1.7	show ip pimsm rphash .....	539
8.5.1.8	show ip pimsm staticrp .....	539
8.5.2	Configuration Commands .....	540
8.5.2.1	ip pimsm .....	540
8.5.2.2	ip pimsm message-interval .....	540
8.5.2.3	ip pimsm register-rate-limit .....	541
8.5.2.4	ip pimsm spt-threshold .....	542
8.5.2.5	ip pimsm staticrp .....	542
8.5.2.6	ip pimsm mode .....	543
8.5.2.7	ip pimsm query-interval .....	543
8.5.2.8	ip pimsm cbspreference .....	544

---

8.5.2.9	ip pimsm cbsrhashmasklength.....	544
8.5.2.10	ip pimsm crppreference .....	545
8.6	IGMP Proxy Commands .....	546
8.6.1	Show Commands.....	546
8.6.1.1	show ip igmp-proxy.....	546
8.6.1.2	show ip igmp-proxy groups.....	547
8.6.1.3	show ip igmp-proxy groups detail .....	547
8.6.1.4	show ip igmp-proxy interface .....	548
8.6.2	Configuration Commands .....	549
8.6.2.1	ip igmp-proxy.....	549
8.6.2.2	ip igmp-proxy reset-status .....	549
8.6.2.3	ip igmp-proxy unsolicit-rprt-interval .....	550
9	IPv6 Commands.....	551
9.1	Tunnel Interface Commands.....	551
9.1.1	Show Commands.....	551
9.1.1.1	show interface tunnel.....	551
9.1.2	Configuration Commands .....	552
9.1.2.1	interface tunnel.....	552
9.1.2.2	tunnel source.....	552
9.1.2.3	tunnel destination .....	553
9.1.2.4	tunnel mode ipv6ip .....	553
9.2	Loopback Interface Commands .....	553
9.2.1	Show Commands.....	554
9.2.1.1	show interface loopback .....	554
9.2.2	Configuration Commands .....	554
9.2.2.1	interface loopback .....	554
9.3	IPv6 Routing Commands .....	555
9.3.1	Show Commands.....	555
9.3.1.1	show ipv6 brief .....	555
9.3.1.2	show ipv6 interface.....	556
9.3.1.3	show ipv6 neighbors.....	557
9.3.1.4	show ipv6 route .....	557
9.3.1.5	show ipv6 route preferences.....	558
9.3.1.6	show ipv6 route summary.....	559
9.3.1.7	show ipv6 vlan.....	559
9.3.1.8	show ipv6 traffic.....	560

---

9.3.1.9	show ipv6 neighbors static.....	563
9.3.2	Configuration Commands .....	563
9.3.2.1	ipv6 forwarding .....	563
9.3.2.2	ipv6 unicast-routing .....	564
9.3.2.3	ipv6 enable .....	564
9.3.2.4	ipv6 address .....	565
9.3.2.5	ipv6 route .....	566
9.3.2.6	ipv6 mtu.....	566
9.3.2.7	ipv6 nd dad attempts .....	567
9.3.2.8	ipv6 nd managed-config-flag .....	567
9.3.2.9	ipv6 nd ns-interval .....	568
9.3.2.10	ipv6 nd other-config-flag .....	568
9.3.2.11	ipv6 nd ra-interval.....	569
9.3.2.12	ipv6 nd ra-lifetime .....	569
9.3.2.13	ipv6 nd reachable-time .....	570
9.3.2.14	ipv6 nd suppress-ra.....	570
9.3.2.15	ipv6 nd prefix.....	571
9.3.2.16	ipv6 neighbor static.....	572
9.4	OSPFv3 Commands .....	572
9.4.1	Show Commands.....	572
9.4.1.1	show ipv6 ospf.....	572
9.4.1.2	show ip ospf abr .....	573
9.4.1.3	show ipv6 ospf area.....	574
9.4.1.4	show ipv6 ospf asbr.....	575
9.4.1.5	show ipv6 ospf database .....	575
9.4.1.6	show ipv6 ospf database database-summary .....	576
9.4.1.7	show ipv6 ospf interface .....	577
9.4.1.8	show ipv6 ospf interface brief .....	578
9.4.1.9	show ipv6 ospf interface stats.....	579
9.4.1.10	show ipv6 ospf neighbor .....	580
9.4.1.11	show ipv6 ospf range.....	581
9.4.1.12	show ipv6 ospf stub table .....	582
9.4.1.13	show ipv6 ospf virtual-link.....	583
9.4.1.14	show ipv6 ospf virtual-link brief .....	583
9.4.2	Configuration Commands .....	584
9.4.2.1	Ipv6 ospf.....	584

---

9.4.2.2	ipv6 ospf areaid .....	584
9.4.2.3	ipv6 ospf cost .....	585
9.4.2.4	ipv6 ospf dead-interval.....	585
9.4.2.5	ipv6 ospf hello-interval.....	586
9.4.2.6	ipv6 ospf mtu-ignore .....	586
9.4.2.7	ipv6 ospf network.....	587
9.4.2.8	ipv6 ospf priority .....	587
9.4.2.9	ipv6 ospf retransmit-interval.....	588
9.4.2.10	ipv6 ospf transmit-delay.....	588
9.4.2.11	ipv6 router ospf.....	589
9.4.2.12	area default-cost (OSPFv3) .....	589
9.4.2.13	area nssa (OSPFv3).....	590
9.4.2.14	area nssa default-info-originate (OSPFv3).....	590
9.4.2.15	area nssa no-redistribute (OSPFv3) .....	591
9.4.2.16	area nssa no-summary (OSPFv3) .....	591
9.4.2.17	area nssa translator-role (OSPFv3) .....	592
9.4.2.18	area nssa translator-stab-intv (OSPFv3).....	592
9.4.2.19	area range (OSPFv3) .....	593
9.4.2.20	area stub (OSPFv3).....	594
9.4.2.21	area stub no-summary (OSPFv3) .....	594
9.4.2.22	area virtual-link (OSPFv3) .....	595
9.4.2.23	area virtual-link dead-interval (OSPFv3) .....	595
9.4.2.24	area virtual-link hello-interval (OSPFv3) .....	596
9.4.2.25	area virtual-link retransmit-interval (OSPFv3) .....	596
9.4.2.26	area virtual-link transmit-delay (OSPFv3) .....	597
9.4.2.27	default-information originate (OSPFv3).....	597
9.4.2.28	default-metric (OSPFv3).....	598
9.4.2.29	distance ospf (OSPFv3).....	598
9.4.2.30	enable (OSPFv3).....	599
9.4.2.31	exit-overflow-interval (OSPFv3) .....	599
9.4.2.32	external-lsdb-limit (OSPFv3).....	600
9.4.2.33	maximum-paths (OSPFv3) .....	601
9.4.2.34	redistribute (OSPFv3).....	601
9.4.2.35	router-id (OSPFv3) .....	602
9.5	RIPng Commands .....	602
9.5.1	Show Commands.....	602

---

---

9.5.1.1	show ipv6 rip .....	602
9.5.2	Configuration Commands .....	603
9.5.2.1	enable .....	603
9.5.2.2	ipv6 rip.....	604
9.5.2.3	default-information originate .....	604
9.5.2.4	default-metric.....	605
9.5.2.5	distance rip .....	605
9.5.2.6	split-horizon .....	605
9.5.2.7	redistribute.....	606
9.5.2.8	ipv6 rip timer.....	607
9.5.2.9	ipv6 rip passive-interface .....	607
9.6	DHCPv6 Commands.....	608
9.6.1	Show Commands.....	608
9.6.1.1	show ipv6 dhcp.....	608
9.6.1.2	show ipv6 dhcp statistics .....	609
9.6.1.3	show ipv6 dhcp interface .....	610
9.6.1.4	show ipv6 dhcp pool.....	610
9.6.1.5	show ipv6 dhcp binding .....	611
9.6.2	Configuration Commands .....	612
9.6.2.1	service dhcpv6 .....	612
9.6.2.2	ipv6 dhcp server .....	612
9.6.2.3	ipv6 dhcp relay destination .....	613
9.6.2.4	ipv6 dhcp relay-agent-info-opt .....	613
9.6.2.5	ipv6 dhcp relay-agent-info-remote-id-subopt.....	614
9.6.2.6	ipv6 dhcp pool .....	614
9.6.2.7	domain-name(IPV6) .....	615
9.6.2.8	dns-server(IPV6) .....	615
9.6.2.9	prefix-delegation (IPV6).....	616
10	Network Cluster Management Commands.....	616
10.1	Cluster Commands .....	617
10.1.1	Show Commands.....	617
10.1.1.1	show cluster .....	617
10.1.1.2	show cluster members.....	618
10.1.1.3	show cluster candidates .....	618
10.1.2	Configuration Commands .....	619
10.1.2.1	cluster.....	619

---

10.1.2.2	cluster register timer .....	619
10.1.2.3	cluster commander .....	620
10.1.2.4	cluster member.....	620
10.1.2.5	cluster auto-add enable .....	621
10.1.2.6	clear cluster candidate-table .....	621
10.1.2.7	cluster holdtime .....	622
10.1.2.8	cluster heartbeat.....	622
10.1.2.9	cluster rcommand member .....	622
10.1.2.10	cluster rcommand commander .....	623
10.1.2.11	cluster reset member .....	623
10.1.2.12	cluster update member .....	624
11	Web-Based Management Interface.....	625
11.1	Overview.....	625
11.2	Main Menu.....	626
11.2.1	System Menu .....	626
11.2.1.1	View ARP Cache .....	626
11.2.1.2	Viewing Inventory Information.....	627
11.2.1.3	Configuring Management Session and Network Parameters.....	629
11.2.1.4	Defining Forwarding Database .....	646
11.2.1.5	Viewing Logs .....	647
11.2.1.6	Managing Switch Interface .....	653
11.2.1.7	Defining SNMP .....	662
11.2.1.8	Viewing Statistics.....	665
11.2.1.9	Managing System Utilities .....	676
11.2.1.10	Defining Trap Manager .....	686
11.2.1.11	Configuring SNTP.....	689
11.2.1.12	Defining DHCP Client .....	695
11.2.1.13	Defining sFlow Function .....	696
11.2.2	Switching Menu.....	698
11.2.2.1	Managing DHCP Filtering .....	698
11.2.2.2	Managing Filters.....	700
11.2.2.3	Managing Port-based VLAN .....	701
11.2.2.4	Managing Protected Ports .....	707
11.2.2.5	Managing Protocol-based VLAN.....	709
11.2.2.6	Managing IP Subnet-based VLAN .....	711
11.2.2.7	Managing MAC-based VLAN.....	712

---

11.2.2.8	Managing MAC-based Voice VLAN .....	714
11.2.2.9	Managing Voice VLAN.....	715
11.2.2.10	Defining GARP .....	716
11.2.2.11	Managing IGMP Snooping.....	720
11.2.2.12	Managing IGMP Snooping Querier .....	728
11.2.2.13	Managing MLD Snooping .....	732
11.2.2.14	Managing MLD Snooping Querier .....	739
11.2.2.15	Managing Port-Channel.....	743
11.2.2.16	Viewing Multicast Forwarding Database .....	745
11.2.2.17	Managing Spanning Tree.....	749
11.2.2.18	Defining 802.1p priority.....	757
11.2.2.19	Managing Port Security .....	758
11.2.2.20	Managing LLDP.....	762
11.2.2.21	Managing LLDP-MED.....	770
11.2.2.22	Managing VTP.....	777
11.2.3	Routing Menu.....	779
11.2.3.1	Managing ARP Table .....	779
11.2.3.2	Managing IP Interfaces.....	782
11.2.3.3	Managing OSPF .....	788
11.2.3.4	Managing BOOTP/DHCP Relay Agent .....	809
11.2.3.5	Managing DNS Relay .....	811
11.2.3.6	Managing Routing Information Protocol (RIP).....	815
11.2.3.7	Managing Router Discovery .....	821
11.2.3.8	Managing Route Table.....	823
11.2.3.9	Managing VLAN Routing .....	828
11.2.3.10	Managing VRRP.....	830
11.2.3.11	Managing Tunnels .....	835
11.2.3.12	Managing Loopbacks .....	837
11.2.4	Security Menu .....	839
11.2.4.1	Managing Access Control (802.1x) .....	839
11.2.4.2	Managing RADIUS .....	850
11.2.4.3	Defining TACACS+ Configuration .....	855
11.2.4.4	Defining IP Filter Configuration .....	857
11.2.4.5	Defining Secure Http Configuration .....	858
11.2.4.6	Defining Secure Shell Configuration .....	859
11.2.5	IPv6 Menu.....	860

11.2.5.1	Configuring IPv6 Global Configuration Page.....	860
11.2.5.2	Configuring IPv6 Interface Configuration Page .....	861
11.2.5.3	Viewing IPv6 Interface Summary Page.....	863
11.2.5.4	Viewing IPv6 Interface Statistics Page.....	864
11.2.5.5	Viewing IPv6 Neighbor Table Information Page .....	870
11.2.5.6	Viewing IPv6 Static Neighbor Table Information Page.....	872
11.2.5.7	Managing DHCPv6 Protocol.....	872
11.2.5.8	Managing OSPFv3 Protocol .....	879
11.2.5.9	Managing IPv6 Routes .....	897
11.2.5.10	Managing RIPv6.....	901
11.2.6	QOS Menu.....	905
11.2.6.1	Managing Access Control Lists.....	905
11.2.6.2	Managing Differentiated Services .....	922
11.2.6.3	Configuring Diffserv Wizard Page.....	930
11.2.6.4	Managing Class of Service .....	932
11.2.7	IP Multicast Menu.....	937
11.2.7.1	Managing DVMRP Protocol.....	937
11.2.7.2	Managing IGMP Protocol.....	943
11.2.7.3	Defining Multicast Configuration .....	953
11.2.7.4	Configuring Multicast Mdebug .....	958
11.2.7.5	Managing PIM-DM Protocol.....	962
11.2.7.6	Managing PIM-SM Protocol.....	964



## 1 Introduction

### 1.1 Switch Description

The LB4M is a modular Gigabit Ethernet backbone switch designed for adaptability and scalability. The Switch can utilize up to 48 Gigabit Ethernet ports to function as a central distribution hub for other switches, switch groups, or routers. The one built-in 1000/100/10 Ethernet ports for out of service. The LB4M also provides SFP+ interfaces for 10-Giga port on the daughter board. The number of 10-Giga ports depend on selecting daughter board.

### 1.2 Features

- Supports 48 10/100/1000BASE-T RJ45 Ethernet ports
- 1 built-in 1000/100/10 Ethernet ports for out of service.
- Supports 802.1D STP, 802.1S MSTP, and 802.1w Rapid Spanning Tree for redundant back up bridge paths
- Supports 802.1Q VLAN, Protocol-based VLAN, Subnet-based VLAN, MAC-based VLAN, Protected Port, Double VLAN, Voice VLAN, GVRP, GMRP, IGMP snooping, 802.1p Priority Queues, Port Channel, port mirroring
- Support LLDP, VTP, Port Security
- Multi-layer Access Control (based on MAC address, IP address, VLAN, Protocol, 802.1p, DSCP)
- Quality of Service (QoS) customized control
- 802.1x (port-based) access control and RADIUS Client support
- Administrator-definable port security
- Per-port bandwidth control
- IEEE 802.3z and IEEE 802.3x compliant Flow Control for all Gigabit ports
- SNMP v.1, v.2, v.3 network management, RMON support
- Supports Web-based management
- CLI management support
- DHCP Client and Relay support
- DNS Client and Relay support
- Fully configurable either in-band or out-of-band control via RS-232 console serial connection
- Telnet remote control console
- TraceRoute support
- Traffic Segmentation
- TFTP upgrade
- SysLog support
- Simple Network Time Protocol
- Web GUI Traffic Monitoring
- SSH Secure Shell version 1 and 2 support
- SSL Secure HTTP TLS Version 1 and SSL version 3 support

- ARP support
- IP Routing support
- OSPF v2 and v3 support
- RIP v1 and v2 support
- Router Discovery Protocol support
- VLAN routing support
- Virtual Router Redundancy Protocol (VRRP) support
- IP Multicast support
- Protocol Independent Multicast - Dense Mode (PIM-DM) support
- Protocol Independent Multicast - Sparse Mode (PIM-SM) support
- IGMP v1, v2, and v3 support
- DVMRP support
- IPV6 function
  - Supports DHCPv6 protocol, OSPFv3 protocol, Tunneling, loopback
  - Provides to configure IPv6 routing interface, routing preference

### 1.3 Front-Panel Components

The front panel of the Switch consists of 48 1-Giga interfaces, 4 LED indicators, one built-in 1000/100/10 RJ-45 Ethernet service ports, an RS-232 communication port.



The upper LED indicators display power situation. The lower LED indicators displays the status of the switch. Two LED indicators display the status of SFP+ interface, An RS-232 DCE console port is for setting up and managing the Switch via a connection to a console terminal or PC using a terminal emulation program.

### 1.4 LED Indicators

The Status LED indicator represents status of the switch. The Power LED indicator represent power ON or OFF.

### 1.5 Rear Panel Description

The rear panel of the Switch contains an redundant AC/DC power unit and three fans.



The redundant AC/DC power unit is a two slots for redundant, hot-swappable power supply. The nominal input voltage in the range from 100 ~ 240 VAC at 48 ~ 62 Hz. The nominal output voltage set point 12 VDC, Minimum/Maximum output current is 2 Amps ~25 Amps.

## 1.6 Management Options

The system may be managed by using two Service Ports through a Web Browser, Telnet, SNMP Function and using the console port on the front panel through CLI command.

## 1.7 Web-based Management Interface

After you have successfully installed the Switch, you can configure the Switch, monitor the LED panel, and display statistics graphically using a Web browser, such as Netscape Navigator (version 6.2 and higher) or Microsoft® Internet Explorer (version 5.0).

**NOTE:** To access the Switch through a Web browser, the computer running the Web browser must have IP-based network access to the Switch.

## 1.8 Command Line Console Interface Through the Serial Port or Telnet

You can also connect a computer or terminal to the serial console port or use Telnet to access the Switch. The command-line-driven interface provides complete access to all switch management features.

## 1.9 SNMP-Based Management

You can manage the Switch with an SNMP-compatible console program. The Switch supports SNMP version 1.0, version 2.0, and version 3.0. The SNMP agent decodes the incoming SNMP messages and responds to requests with MIB objects stored in the database. The SNMP agent updates the MIB objects to generate statistics. The Switch supports a

comprehensive set of MIB extensions:

- RFC1643 Ether-like MIB
- RFC1493 Bridge
- RFC 2819 RMON
- RFC 2233 Interface MIB
- RFC 2571 (SNMP Frameworks)
- RFC 2572 (Message Processing for SNMP)
- RFC 2573 (SNMP Applications)
- RFC 2576 (Coexistence between SNMPs)
- RFC 2618 (Radius-Auth-Client-MIB)
- RFC 2620 (Radius-Acc-Client-MIB)
- RFC 1724 (RIPv2-MIB)
- RFC 1850 (OSPF-MIB)
- RFC 1850 (OSPF-TRAP-MIB)
- RFC 2787 (VRRP-MIB)
- RFC 3289 - DIFFSERV-DSCP-TC
- RFC 3289 - DIFFSERV-MIB
- QOS-DIFFSERV-EXTENSIONS-MIB
- QOS-DIFFSERV-PRIVATE-MIB
- RFC 2674 802.1p
- RFC 2932 (IPMROUTE-MIB)
- Quanta Enterprise MIB
- ROUTING-MIB
- MGMD-MIB
- RFC 2934 PIM-MIB
- DVMRP-STD-MIB
- IANA-RTPROTO-MIB
- MULTICAST-MIB
- FASTPATH-ROUTING6-MIB
- IEEE8021-PAE-MIB
- INVENTORY-MIB
- MGMT-SECURITY-MIB
- QOS-ACL-MIB
- QOS-COS-MIB
- RFC 1907 - SNMPv2-MIB
- RFC 2465 - IPV6-MIB
- RFC 2466 - IPV6-ICMP-MIB
- TACACS-MIB
- USM-TARGET-TAG-MIB
- IGMP/MLD Snooping
- IGMP/MLD Layer2 Multicast
- QoS – IPv6 ACL
- Voice VLAN
- Guest VLAN
- LLDP MED
- RFC 2925 (DISMAN-TRACEROUTE-MIB)
- RFC 2080 (RIPng)



## 2 Installation and Quick Startup

### 2.1 Package Contents

Before you begin installing the Switch, confirm that your package contains the following items:

- One LB4M Layer III Gigabit Switch
- Mounting kit: 2 mounting brackets and screws
- Four rubber feet with adhesive backing
- One AC power cord
- This User's Guide with Registration Card
- CLI Reference
- CD-ROM with User's Guide and CLI Reference

### 2.2 Switch Installation

#### Installing the Switch Without the Rack

1. Install the Switch on a level surface that can safely support the weight of the Switch and its attached cables. The Switch must have adequate space for ventilation and for accessing cable connectors.
2. Set the Switch on a flat surface and check for proper ventilation. Allow at least 5 cm (2 inches) on each side of the Switch and 15 cm (6 inches) at the back for the power cable.
3. Attach the rubber feet on the marked locations on the bottom of the chassis.  
The rubber feet are recommended to keep the unit from slipping.

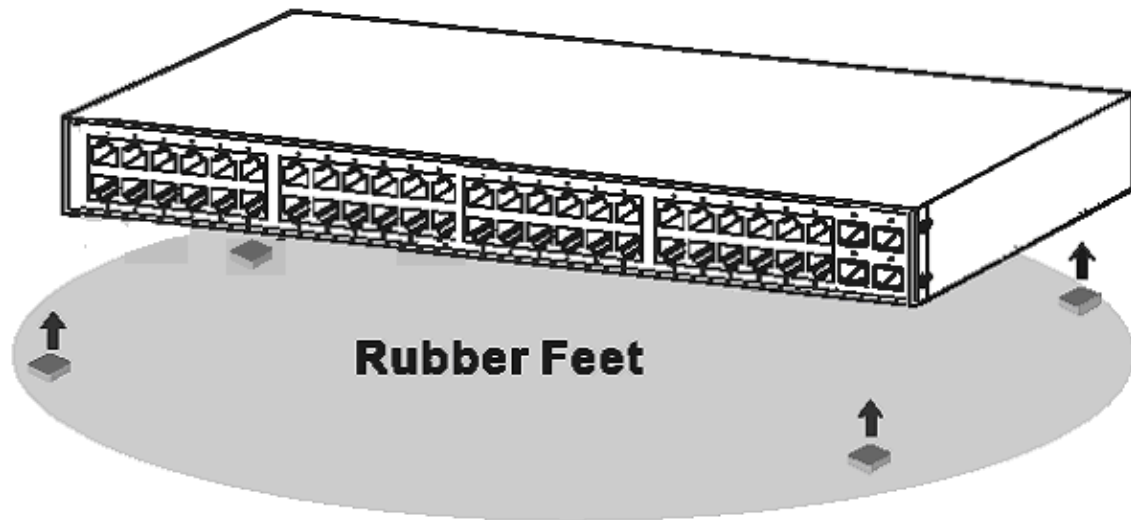

Figure 2-1. Install rubber feet for installations with or without a rack

### 2.3 Installing the Switch in a Rack

You can install the Switch in most standard 19-inch (48.3-cm) racks. Refer to the illustrations below.

1. Use the supplied screws to attach a mounting bracket to each side of the Switch.
2. Align the holes in the mounting bracket with the holes in the rack.
3. Insert and tighten two screws through each of the mounting brackets.

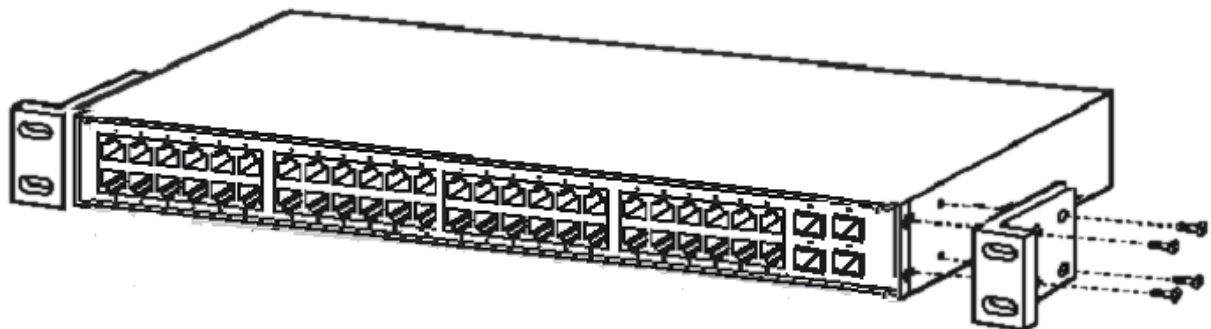

Figure 2-2. Attach mounting brackets

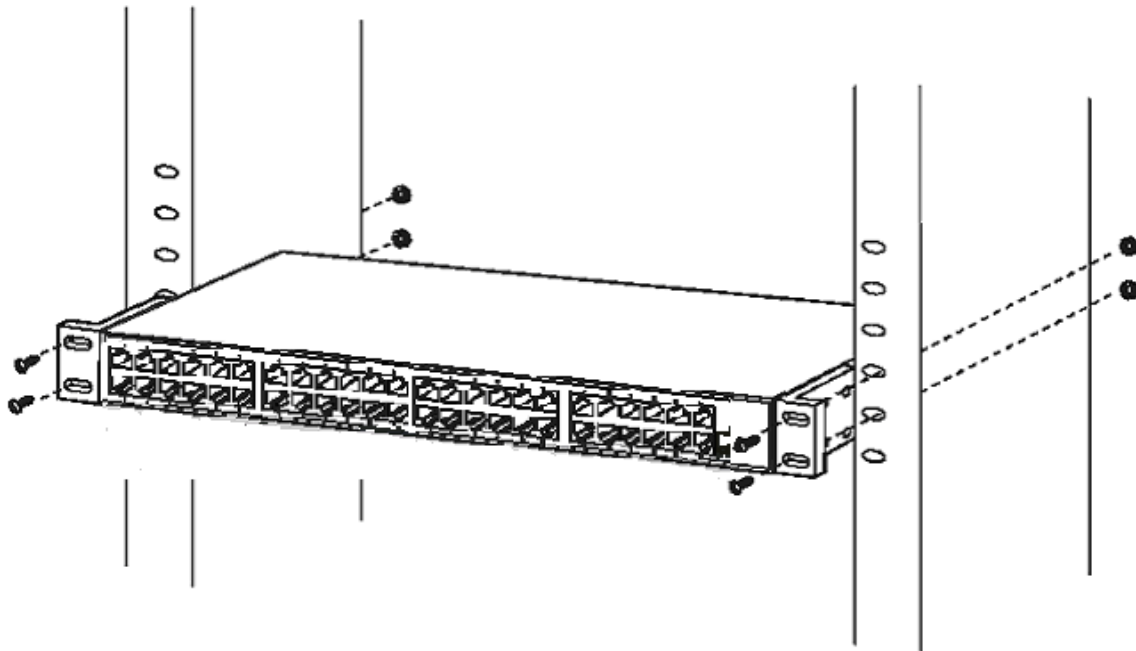

Figure 2-3. Install switch in equipment rack

## 2.4 Quick Starting the Switch

1. Read the device Installation Guide for the connectivity procedure. In-band connectivity allows access to the LB4M Series Switch locally. From a remote workstation, the device must be configured with IP information (IP address, subnet mask, and default gateway).
2. Turn the Power ON.
3. Allow the device to load the software until the login prompt appears. The device initial state is called the default mode.
4. When the prompt asks for operator login, do the following:
  - Type the word **admin** in the login area. Since a number of the Quick Setup commands require administrator account rights, QUANTA suggests logging into an administrator account.
  - Do not enter a password because there is no password in the default mode.
  - Press the <Enter> key
  - The CLI Privileged EXEC mode prompt will be displayed.
  - Use "configure" to switch to the Global Config mode from Privileged EXEC.
  - Use "exit" to return to the previous mode.



## 2.5 System Information Setup

### 2.5.1 Quick Start up Software Version Information

**Table 2-1. Quick Start up Software Version Information**

<b>Command</b>	<b>Details</b>
<b>show hardware</b>	Allows the user to see the HW & SW version the device contains  System Description - switch's model name
<b>show version</b>	Burned in MAC address - MAC address assigned to this switch CPU  See the HW & SW version

### 2.5.2 Quick Start up Physical Port Data

**Table 2-2. Quick Start up Physical Port**

<b>Command</b>	<b>Details</b>
<b>show Interface status</b> { <slot/port>   all}	Displays the Ports slot/port  Type - Indicates if the port is a special type of port  Admin Mode - Selects the Port Control Administration State  Physical Mode - Selects the desired port speed and duplex mode  Physical Status - Indicates the port speed and duplex mode  Link Status - Indicates whether the link is

	<p>up or down</p> <p>Link Trap - Determines whether or not to send a trap when link status changes</p> <p>LACP Mode - Displays whether LACP is enabled or disabled on this port</p> <p>Flow Mode - Indicates the status of flow control on this port</p> <p>Cap. Status - Indicates the port capabilities during auto-negotiation</p>
--	---

### 2.5.3 Quick Start up User Account Management

**Table 2-3. Quick Start up User Account Management**

<b>Command</b>	<b>Details</b>
<b>show users</b>	<p>Displays all users that are allowed to access the switch</p> <p>User Access Mode - Shows whether the user is able to change parameters on the switch (Read/Write) or is only able to view (Read Only).</p> <p>As a factory default, admin has Read/Write access and guest has Read Only access. There can only be one Read/Write user and up to 5 Read Only users.</p>
<b>show login session</b>	Displays all login session information
<b>username &lt;username&gt; {passwd   nopasswd}</b>	<p>Allows the user to set passwords or change passwords needed to login</p> <p>A prompt will appear after the command is entered requesting the old password. In the absence of an old password leave the area blank. The operator must press enter to execute the command.</p> <p>The system then prompts the user for a new password then a prompt to confirm the new password. If the new password and the confirmed password match a message will be displayed.</p> <p>The user password should not be more</p>

	than eight characters in length.
<b>copy running-config startup-config [filename]</b>	This will save passwords and all other changes to the device.  If you do not save config, all configurations will be lost when a power cycle is performed on the switch or when the switch is reset.

### 2.5.4 Quick Start up IP Address

To view the network parameters the operator can access the device by the following three methods.

- Simple Network Management Protocol - SNMP
- Telnet
- Web Browser

**Table 2-4. Quick Start up IP Address**

<b>Command</b>	<b>Details</b>
<b>show ip interface</b>	Displays the Network Configurations IP Address - IP Address of the interface Default IP is 0.0.0.0 Subnet Mask - IP Subnet Mask for the interface Default is 0.0.0.0 Default Gateway - The default Gateway for this interface Default value is 0.0.0.0 Burned in MAC Address - The Burned in MAC Address used for inband connectivity Network Configurations Protocol Current - Indicates which network protocol is being used Default is none Management VLAN Id - Specifies VLAN id

	<p>Web Mode - Indicates whether HTTP/Web is enabled.</p> <p><b>Java Mode - Indicates whether java mode is enabled.</b></p>
<b>ip address</b>	<p>(Config)#<b>interface vlan 1</b></p> <p>(if-vlan 1)#<b>ip address &lt;ipaddr&gt; &lt;netmask&gt;</b></p> <p>(if-vlan 1)#<b>exit</b></p> <p>(Config)#<b>ip default-gateway &lt;gateway&gt;</b></p> <p>IP Address range from 0.0.0.0 to 255.255.255.255</p> <p>Subnet Mask range from 0.0.0.0 to 255.255.255.255</p> <p>Gateway Address range from 0.0.0.0 to 255.255.255.255</p> <p>Displays all of the login session information</p>

### 2.5.5 Quick Start up Uploading from Switch to Out-of-Band PC (Only XMODEM)

**Table 2-5. Quick Start up Uploading from Switch to Out-of-Band PC (XMODEM)**

<b>Command</b>	<b>Details</b>
<b>copy startup-config &lt;filename&gt; xmodem</b>	<p>This starts the upload and displays the mode of uploading and the type of upload it is and confirms the upload is taking place.</p> <p>For example:</p> <p>If the user is using HyperTerminal, the user must specify where the file is going to be received by the pc.</p>

### 2.5.6 Quick Start up Downloading from Out-of-Band PC to Switch (Only XMODEM)

**Table 2-6 Quick Start up Downloading from Out-of-Band PC to Switch**

Command	Details
<b>copy xmodem startup-config &lt;filename&gt;</b>	<p>Sets the download datatype to be an image or config file.</p> <p>The URL must be specified as: xmodem: filepath/ filename</p> <p>For example:</p> <p>If the user is using HyperTerminal, the user must specify which file is to be sent to the switch. The Switch will restart automatically once the code has been downloaded.</p>

### 2.5.7 Quick Start up Downloading from TFTP Server

Before starting a TFTP server download, the operator must complete the Quick Start up for the IPAddress.

**Table 2-7 Quick Start up Downloading from TFTP Server**

Command	Details
<b>copy &lt;url&gt; startup-config &lt;filename&gt;</b>	<p>Sets the download datatype to be an image or config file.</p> <p>The URL must be specified as: tftp://ipAddr/filepath/fileName.</p> <p>The startup-config option downloads the config file using tftp and image option downloads the code file.</p>

### 2.5.8 Quick Start up Factory Defaults

**Table 2-8 Quick Start up Factory Defaults**

Command	Details
<b>clear config</b>	<p>Enter yes when the prompt pops up to clear all the configurations made to the switch.</p>

<b>copy running-config startup-config [filename]</b>	Enter yes when the prompt pops up that asks if you want to save the configurations made to the switch.
<b>reload</b>	Enter yes when the prompt pops up that asks if you want to reset the system. You can reset the switch or cold boot the switch; both work effectively.

### 3 Console and Telnet Administration Interface

This chapter discusses many of the features used to manage the Switch, and explains many concepts and important points regarding these features. Configuring the Switch to implement these concepts is discussed in detail in chapter 6.

#### 3.1 Local Console Management

Local console management involves the administration of the Switch via a direct connection to the RS-232 DCE console port. This is an Out-of-band connection, meaning that it is on a different circuit than normal network communications, and thus works even when the network is down.

The local console management connection involves a terminal or PC running terminal emulation software to operate the Switch's built-in console program (see Chapter 6). Using the console program, a network administrator can manage, control, and monitor many functions of the Switch. Hardware components in the Switch allow it to be an active part of a manageable network. These components include a CPU, memory for data storage, other related hardware, and SNMP agent firmware. Activities on the Switch can be monitored with these components, while the Switch can be manipulated to carry out specific tasks.

#### 3.2 Set Up your Switch Using Console Access

Out-of-band management requires connecting a terminal, such as a VT-100 or a PC running a terminal-emulation program (such as HyperTerminal, which is automatically installed with Microsoft Windows) to the RS-232 DCE console port of the Switch. Switch management using the RS-232 DCE console port is called *Local Console Management* to differentiate it from management done via management platforms, such as DView or HP OpenView.

Make sure the terminal or PC you are using to make this connection is configured to match these settings. If you are having problems making this connection on a PC, make sure the emulation is set to VT-100 or ANSI. If you still don't see anything, try pressing <Ctrl> + r to refresh the screen.

First-time configuration must be carried out through a console, that is, either (a) a VT100-type serial data terminal, or (b) a computer running communications software set to emulate a VT100. The console must be connected to the Diagnostics port. This is an RS-232 port with a 9-socket D-shell connector and DCE-type wiring. Make the connection as follows:

1. Obtain suitable cabling for the connection.  
You can use a null-modem RS-232 cable or an ordinary RS-232 cable and a null-modem adapter. One end of the cable (or cable/adapter combination) must have a 9-pin D-shell connector suitable for the Diagnostics port; the other end must have a connector suitable for the console's serial communications port.
2. Power down the devices, attach the cable (or cable/adapter combination) to the correct ports, and restore power.
3. Set the console to use the following communication parameters for your terminal:

- . The console port is set for the following configuration:
- . Baud rate: 11,520
- . Data width: 8 bits
- . Parity: none
- . Stop bits: 1
- . Flow Control none

A typical console connection is illustrated below:

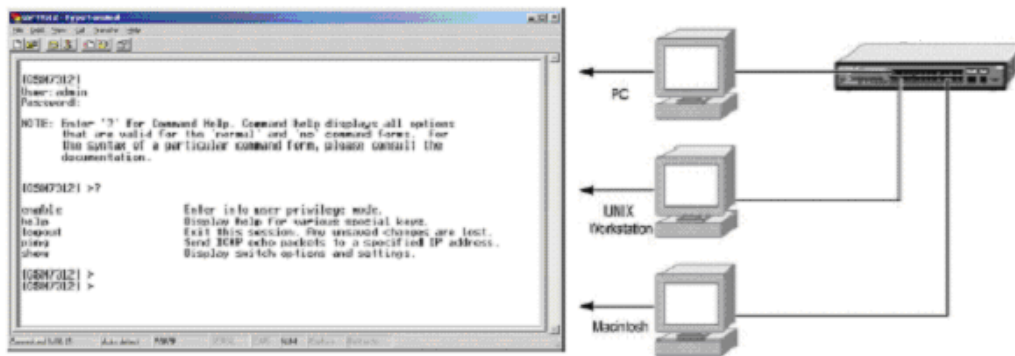

Figure 3-1: Console Setting Environment

### 3.3 Set Up your Switch Using Telnet Access

Once you have set an IP address for your Switch, you can use a Telnet program (in a VT-100 compatible terminal mode) to access and control the Switch. Most of the screens are identical, whether accessed from the console port or from a Telnet interface.



## 4 Web-Based Management Interface

### 4.1 Overview

The Quanta LB4M Series Layer III plus QoS Managed Switch provides a built-in browser interface that lets you configure and manage it remotely using a standard Web browser such as Microsoft Internet Explorer 5.0 or later or Netscape Navigator 6.0 or later. This interface also allows for system monitoring and management of the switch. The 'help' page covers many of the basic functions and features of the switch and its Web interface. When you configure the switch for the first time from the console, you can assign an IP address and subnet mask to the switch. Thereafter, you can access the switch's Web interface directly using your Web browser by entering the switch's IP address into the address bar. In this way, you can use your Web browser to manage the switch from a central location, just as if you were directly connected to the switch's console port. Figure 4-1 shows this management method.

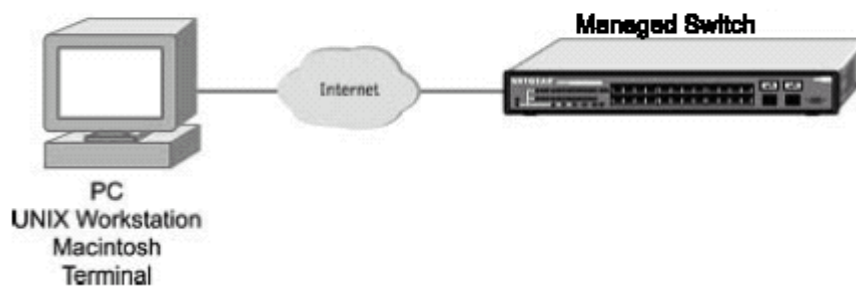

Figure 4-1: Web Management Method

### 4.2 How to log in

The Quanta LB4M Series Layer III plus QoS Managed Switch can be configured remotely from Microsoft Internet Explorer (version 5.0 or above), or Netscape Navigator (version 4.78 or above).

1. Determine the IP address of your managed switch.
2. Open your Web browser.
3. Log in to the managed switch using whatever IP address the unit is currently configured with. Use the default user name of **admin** and default of no password, or whatever LAN address and password you have set up.

A login window opens:

Click the Login link.

A user name and password dialog box opens.

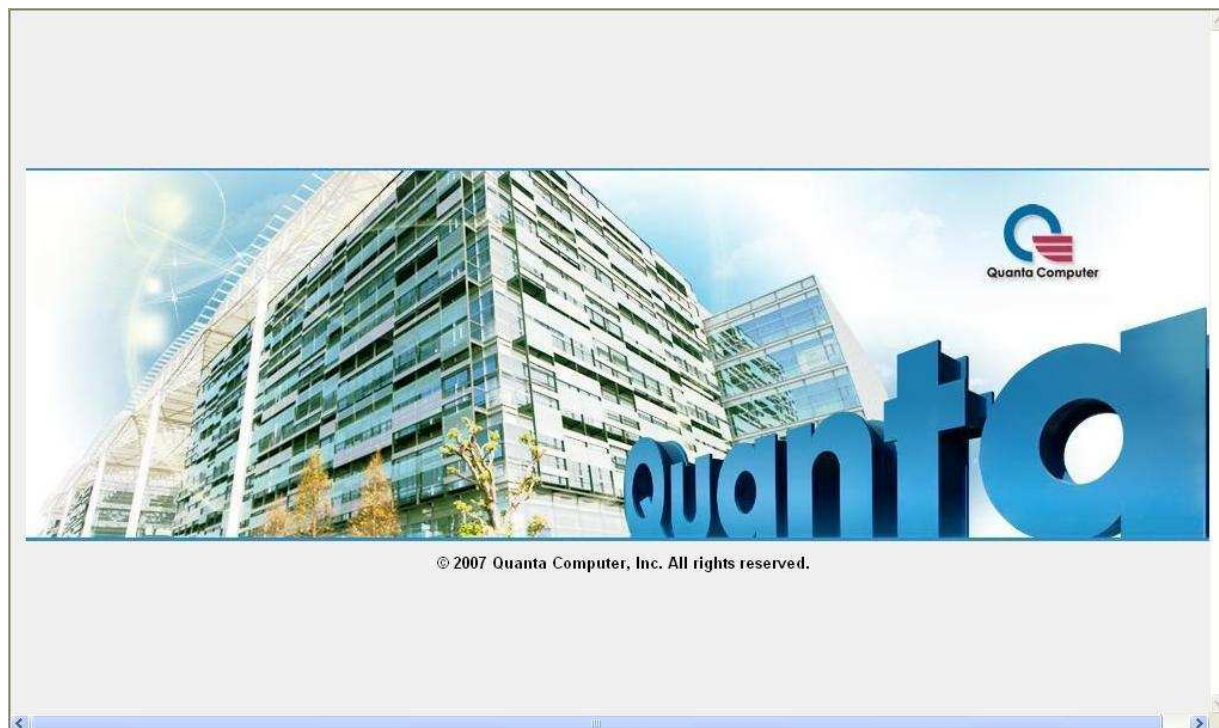

**Figure 4-2: Login splash screen for the Managed Switch**

4. Type the default user name of **admin** and default of no password, or whatever password you have set up.

Once you have entered your access point name, your Web browser automatically finds the LB4M Series Layer III Switch and display the home page, as shown below.

### 4.3 Web-Based Management Menu

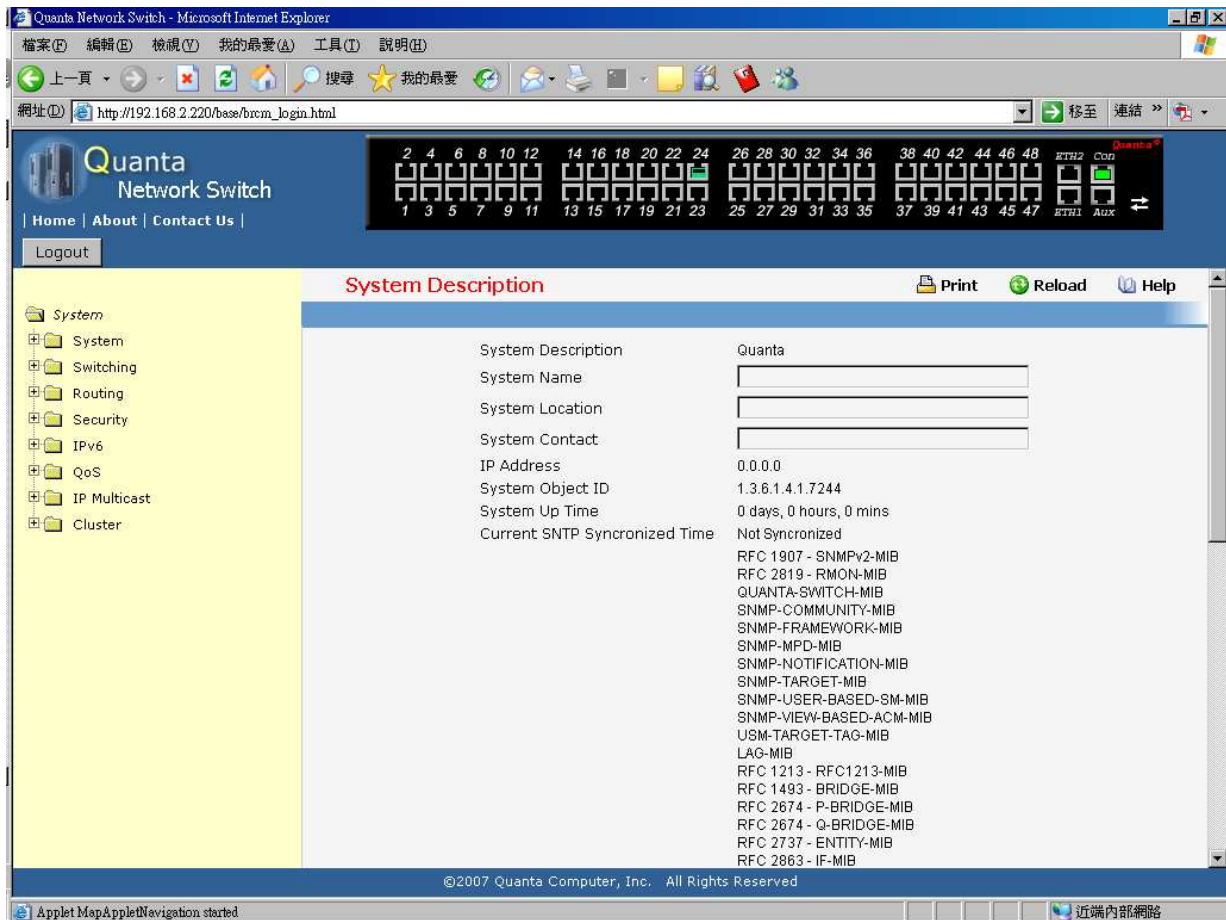

Figure 4-3: System Information page

This above page displays system information, such as:

- System Description
- System Name
- System Location
- System Contact
- IP Address
- System Object ID (OID)
- System Up Time

## Menus

The Web-based interface enables navigation through several menus. The main navigation menu is on the left of every page and contains the screens that let you access all the commands and statistics the switch provides.

## Main Menu

- System
- Switching
- Routing
- Security
- IPv6

- QoS
- IP Multicast
- Cluster

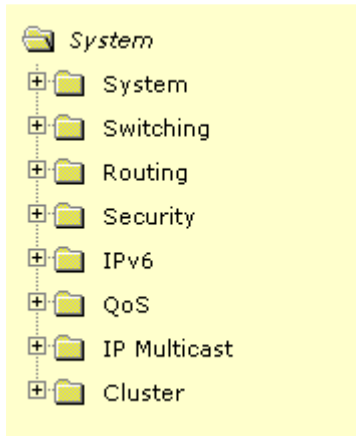

## Secondary Menus

The Secondary Menus under the Main Menu contain a host of options that you can use to configure your switch. The online help contains a detailed description of the features on each screen. You can click the 'help' or the question mark at the top right of each screen to view the help menu topics.

The Secondary Menus are detailed below, with cross-references to the sections in this manual that contain the corresponding command descriptions.

### System

- ARP Cache — see “show arp”
- Inventory — see “show hardware”
- Configuration — see “Management Commands and Device Configuration Commands”
- Forwarding Database — see “Device Configuration Commands’ L2MAC Address”
- Logs — see “System Information and Statistics Commands”
- Port — see “Device Configuration Commands’ Interface”
- SNMP — see “SNMP Server Commands and SNMP Trap Commands”
- Statistics — see “show interface counters”
- System Utilities — see “System Utilities”
- Trap Manager — see “show traplog and SNMP Trap Commands”
- SNTP — see “SNTP Commands”
- DHCP Client — see “DHCP Client Commands”
- sFlow — see “sFlow Commands”

### Switching

- DHCP Filtering — see “DHCP Filtering Commands”
- Filters — see “MAC Filters Commands”
- VLAN — see “VLAN Management Commands”

- Protected Port — see “Protected Port Commands”
- Protocol-based VLAN — see “Protocol-based VLAN Commands”
- IP Subnet-based VLAN — see “IP Subnet-based VLAN Commands”
- MAC-based — see “MAC-based Commands”
- Voice VLAN — see “Voice VLAN Commands”
- GARP — see “GVRP and Bridge Extension Commands”
- IGMP Snooping — see “IGMP Snooping Commands”
- Port Channel — see “Port Channel Commands”
- Multicast Forwarding DataBase — see “L2 MAC Address and Multicast Forwarding Database Tables Commands”
- Spanning Tree — see “Spanning Tree Commands”
- Class of Service — see “L2 Priority Commands”
- Port Security — see “Port Security Configuration Commands”
- LLDP — see “LLDP Commands”
- VTP — see “VTP Commands”

## Routing

- ARP — see “Address Resolution Protocol (ARP) Commands”
- IP — see “IP Routing Commands”
- OSPF — see “Open Shortest Path First (OSPF) Commands”
- BOOTP/DHCP Relay Agent — see “BOOTP/DHCP Relay Commands”
- DNS Relay — see “Domain Name Server Relay Commands”
- RIP — see “Routing Information Protocol (RIP) Commands”
- Router Discovery — see “Router Discovery Protocol Commands”
- Router — see “IP Routing Commands”
- VLAN Routing — see “VLAN Routing Commands”
- VRRP — see “Virtual Router Redundancy Protocol (VRRP) Commands”
- Tunnels — see “Tunnels Commands”
- Loopbacks — see “Loopbacks Commands”

## Security

- Port Access Control — see “Dot1x Configuration Commands”
- RADIUS — see “Radius Configuration Commands”
- TACACS+ — see “TACACS+ Configuration Commands”
- IP Filter — see “Network Commands”
- Secure HTTP — see “HTTP Commands”
- Secure Shell — see “Secure Shell (SSH) Commands”

## IPv6

- DHCPv6 — see “DHCPv6 Configuration Commands”
- OSPFv3 — see “OSPFv3 Configuration Commands”
- IPv6 Routes — see “IPv6 Routes Configuration Commands”

## QoS

- ACL — see “ACL Commands”

- Diffserv — see “Differentiated Services Commands”
- Class of Service see "Class of Service Commands"

### **IP Multicast**

- DVMRP — see “DVMRP Commands”
- IGMP — see “IGMP Commands”
- Multicast — see “Multicast Commands”
- MDebug — see “Multicast Commands”
- PIM-DM — see “PIM-DM Commands”
- PIM-SM — see “PIM-SM Commands”

### **Cluster**

- Cluster — see “Cluster Commands”

## 5 Command Line Interface Structure and Mode-based CLI

The Command Line Interface (CLI) syntax, conventions, and terminology are described in this section. Each CLI command is illustrated using the structure outlined below.

### 5.1 CLI Command Format

Commands are followed by values, parameters, or both.

#### Example 1

**IP address <ipaddr> <netmask> [<gateway>]**

- **ip address** is the command name.
- **<ipaddr> <netmask>** are the required values for the command.
- **[<gateway>]** is the optional value for the command.

#### Example 2

**snmp-server host <loc>**

- **snmp-server location** is the command name.
- **<loc>** is the required parameter for the command.

#### Example 3

**clear vlan**

- **clear vlan** is the command name.

#### Command

The text in bold, non-italic font must be typed exactly as shown.

### 5.2 CLI Mode-based Topology

#### Parameters

Parameters are order dependent.

The text in bold italics should be replaced with a name or number. To use spaces as part of a name parameter, enclose it in double quotes like this: "System Name with Spaces".

Parameters may be mandatory values, optional values, choices, or a combination.

- **<parameter>**. The <> angle brackets indicate that a mandatory parameter must be entered in place of the brackets and text inside them.
- **[parameter]**. The [] square brackets indicate that an optional parameter may be entered in place of the brackets and text inside them.
- **choice1 | choice2**. The | indicates that only one of the parameters should be entered. The {} curly braces indicate that a parameter must be chosen from the list of choices.

## Values

**ipaddr** This parameter is a valid IP address, made up of four decimal bytes ranging from 0 to 255. The default for all IP parameters consists of zeros (that is, 0.0.0.0). The interface IP address of 0.0.0.0 is invalid.

**macaddr** The MAC address format is six hexadecimal numbers separated by colons, for example 00:06:29:32:81:40.

**areaid** Area IDs may be entered in dotted-decimal notation (for example, 0.0.0.1). An area ID of 0.0.0.0 is reserved for the backbone. Area IDs have the same form as IP addresses, but are distinct from IP addresses. The IP network number of the sub-netted network may be used for the area ID.

**routerid** The value of <router id> must be entered in 4-digit dotted-decimal notation (for example, 0.0.0.1). A router ID of 0.0.0.0 is invalid.

**slot/port** This parameter denotes a valid slot number, and a valid port number. For example, 0/1 represents unit number 1, slot number 0 and port number 1. The <slot/port> field is composed of a valid slot number and a valid port number separated by a forward slash (/).

**logical slot/port** This parameter denotes a logical slot number, and logical port number assigned. This is applicable in the case of a port-channel (LAG). The operator can use the logical slot number, and the logical port number to configure the port-channel.

## Conventions

Network addresses are used to define a link to a remote host, workstation, or network. Network addresses are shown using the following syntax:

**Table 5-1. Network Address Syntax**

Address Type	Format	Range
IPAddr	A.B.C.D	0.0.0.0 to 255.255.255.255
MacAddr	YY:YY:YY:YY:YY:YY	hexadecimal digit pairs

Double quotation marks such as "System Name with Spaces" set off user defined strings. If the operator wishes to use spaces as part of a name parameter then it must be enclosed in double quotation marks.

Empty strings ("" ) are not valid user defined strings. Command completion finishes spelling the command when enough letters of a command are typed to uniquely identify the command word. The command may be executed by typing <enter> (command abbreviation) or



the command word may be completed by typing the <tab> or <space bar> (command completion).

The value 'Err' designates that the requested value was not internally accessible. This should never happen and indicates that there is a case in the software that is not handled correctly.

The value of '-----' designates that the value is unknown.

### **Annotations**

The CLI allows the user to type single-line annotations at the command prompt for use when writing test or configuration scripts and for better readability. The exclamation point (!) character flags the beginning of a comment. The comment flag character can begin a word anywhere on the command line and all input following this character is ignored. Any command line that begins with the character '!' is recognized as a comment line and ignored by the parser.

Some examples are provided below:

```
! Script file for displaying the ip interface  
! Display information about interfaces  
show ip interface 0/1 !Displays the information about the first interface  
! Display information about the next interface  
show ip interface 0/2  
! End of the script file
```

## 6 Switching Commands

### 6.1 System Information and Statistics commands

#### 6.1.1 show arp

This command displays connectivity between the switch and other devices. The Address Resolution Protocol (ARP) cache identifies the MAC addresses of the IP stations communicating with the switch.

<b>Syntax</b>
---------------

<code>show arp</code>
-----------------------

#### Default Setting

None

#### Command Mode

Privileged Exec

#### Display Message

**MAC Address:** A unicast MAC address for which the switch has forwarding and/or filtering information. The format is 6 two-digit hexadecimal numbers that are separated by colons. For example: 00:23:45:67:89:AB

**IP Address:** The IP address assigned to each interface.

**Interface:** Valid slot number and a valid port number.

#### 6.1.2 show calendar

This command displays the system time.

<b>Syntax</b>
---------------

<code>show calendar</code>
----------------------------

**Default Setting**

None

**Command Mode**

Privileged Exec

**Display Message****Current Time** displays system time**6.1.3 show eventlog**

This command displays the event log, which contains error messages from the system, in the Primary Management System or in the specified unit. The event log is not cleared on a system reset.

**Syntax**

```
show eventlog [unit]
```

**unit** - The unit number of the remote system. The range is 1 to 8.

**Default Setting**

None

**Command Mode**

Privileged Exec

**Display Message**

**File:** The file in which the event originated.

**Line:** The line number of the event.

**Task Id:** The task ID of the event.

**Code:** The event code.

**Time:** The time this event occurred.

**Note:** Event log information is retained across a switch reset.

### 6.1.4 show running-config

This command is used to display/capture the current setting of different protocol packages supported on switch. This command displays/captures only commands with settings/configurations with values that differ from the default value. The output is displayed in script format, which can be used to configure another switch with the same configuration. When a script name is provided, the output is redirected to a configuration script. The option [all] will also enable the display/capture of all commands with settings/configurations that include values that are same as the default values. If the optional <scriptname> is provided with a file name extension of “.scr”, the output will be redirected to a script file.

<b>Syntax</b>
---------------

<b>show running-config [all   &lt;scriptname&gt;]</b>
---

**all** - enable the display/capture of all commands with settings/configurations that include values that are same as the default values.

**<scriptname>** - redirect the output to the file <scriptname>.

#### Default Setting

None

#### Command Mode

Privileged Exec

### 6.1.5 show sysinfo

This command displays switch brief information and MIBs supported.

<b>Syntax</b>
---------------

<b>show sysinfo</b>
---------------------

#### Default Setting

None

#### Command Mode

Privileged Exec

#### Display Message

**System Description:** The text used to identify this switch.

**System Name:** The name used to identify the switch.

**System Location:** The text used to identify the location of the switch. May be up to 31 alpha-numeric characters. The factory default is blank.

**System Contact:** The text used to identify a contact person for this switch. May be up to 31 alphanumeric characters. The factory default is blank.

**System Object ID:** The manufacturing ID.

**System Up Time:** The time in days, hours and minutes since the last switch reboot.

**Current SNTP Synchronized Time:** The time which is synchronized from SNTP server.

**MIBs Supported:** A list of MIBs supported by this agent.

### 6.1.6 show tech-support

This command displays system and configuration information when you contact technical support. The output of the show tech-support command combines the output of the following commands: **show version, show sysinfo, show port all, show logging, show event log, • show logging buffered, show trap log, show running config.**

<b>Syntax</b>
---------------

<b>show tech-support</b>
--------------------------

#### Default Setting

None

#### Command Mode

Privileged Exec

### 6.1.7 show hardware

This command displays inventory information for the switch.

<b>Syntax</b>
---------------

<b>show hardware</b>
----------------------

#### Default Setting

None

**Command Mode**

Privileged Exec

**Display Message****System Description:** Text used to identify the product name of this switch.**Machine Type:** Specifies the machine model as defined by the Vital Product Data.**Machine Model:** Specifies the machine model as defined by the Vital Product Data.**Serial Number:** The unique box serial number for this switch.**Label Revision Number:** The label revision serial number of this switch is used for manufacturing purposes.**Part Number:** Manufacturing part number.**Hardware Version:** The hardware version of this switch. It is divided into four parts. The first byte is the major version and the second byte represents the minor version.**Loader Version:** The release version maintenance number of the loader code currently running on the switch. For example, if the release was 1, the version was 2, and the maintenance number was 4, the format would be '1.2.4'.**Boot Rom Version:** The release version maintenance number of the boot ROM code currently running on the switch. For example, if the release was 1, the version was 2, and the maintenance number was 4, the format would be '1.2.4'.**Operating Code Version:** The release version maintenance number of the code currently running on the switch. For example, if the release was 1, the version was 2, and the maintenance number was 4, the format would be '1.2.4'.**Note:below 10-Giga Interface information depend on plugging daughter's module and LB4M model type****When using LB4M model type-hybrid:****Switch 1 Module x, Found 6 Ports Active CX4 10G Daughter Board****Switch 1 10G's Module x** (The xth 10-Giga Module daughter board of switch 1).**Switch 1 Interface = y..... CX4** (The yth 10-Giga information of switch 1).**Switch 1 Module x, Found 6 Ports SFP Plus 10G Daughter Board****Switch 1 10G's Module x** (The xth 10-Giga Module daughter board of switch 1).**Switch 1 Interface = y..... SFP+**(The yth 10-Giga information of switch 1).**10 Gigabit Ethernet Compliance Codes:** Transceiver's compliance codes.**Vendor Name:** The SFP transceiver vendor name shall be the full name of the corporation, a commonly accepted abbreviation of the name of the corporation, the SCSI company code for the corporation, or the stock exchange code for the corporation.**Vendor Part Number:** Part number provided by SFP transceiver vendor.**Vendor Serial Number:** Serial number provided by vendor.**Vendor Revision Number:** Revision level for part number provided by vendor.**Vendor Manufacturing Date:** The vendor's manufacturing date.**Switch 1 Module x, Found 4 Ports Active CX4 10G Daughter Board****Switch 1 10G's Module x** (The xth 10-Giga Module daughter board of switch 1).**Switch 1 Interface = y..... CX4** (The yth 10-Giga information of switch 1).**Switch 1 Module x, Found 4 Ports SFP Plus 10G Daughter Board****Switch 1 10G's Module x** (The xth 10-Giga Module daughter board of switch 1).**Switch 1 Interface = y..... SFP+**(The yth 10-Giga information of switch 1)**10 Gigabit Ethernet Compliance Codes:** Transceiver's compliance codes.**Vendor Name:** The SFP transceiver vendor name shall be the full name of the corporation,

a commonly accepted abbreviation of the name of the corporation, the SCSI company code for the corporation, or the stock exchange code for the corporation.

**Vendor Part Number:** Part number provided by SFP transceiver vendor.

**Vendor Serial Number:** Serial number provided by vendor.

**Vendor Revision Number:** Revision level for part number provided by vendor.

**Vendor Manufacturing Date:** The vendor's manufacturing date.

**When using LB4M model type-CX4:**

**Switch 1 Module x, Found 6 Ports Active CX4 10G Daughter Board**

**Switch 1 10G's Module x** (The xth 10-Giga Module daughter board of switch 1).

**Switch 1 Interface = y..... CX4** (The yth 10-Giga information of switch 1).

**Switch 1 Module x, Found 6 Ports Active CX4 10G Daughter Board**

**Switch 1 10G's Module x** (The xth 10-Giga Module daughter board of switch 1).

**Switch 1 Interface = y..... CX4** (The yth 10-Giga information of switch 1).

**Switch 1 Module x, Found 4 Ports Active CX4 10G Daughter Board**

**Switch 1 10G's Module x** (The xth 10-Giga Module daughter board of switch 1).

**Switch 1 Interface = y..... CX4** (The yth 10-Giga information of switch 1).

**Switch 1 Module x, Found 4 Ports Active CX4 10G Daughter Board**

**Switch 1 10G's Module x** (The xth 10-Giga Module daughter board of switch 1).

**Switch 1 Interface = y..... CX4** (The yth 10-Giga information of switch 1).

**When using LB4M model type-SFP+:**

**Switch 1 Module x, Found 6 Ports SFP Plus 10G Daughter Board**

**Switch 1 10G's Module x** (The xth 10-Giga Module daughter board of switch 1).

**Switch 1 Interface = y..... SFP+**(The yth 10-Giga information of switch 1).

**10 Gigabit Ethernet Compliance Codes:** Transceiver's compliance codes.

**Vendor Name:** The SFP transceiver vendor name shall be the full name of the corporation, a commonly accepted abbreviation of the name of the corporation, the SCSI company code for the corporation, or the stock exchange code for the corporation.

**Vendor Part Number:** Part number provided by SFP transceiver vendor.

**Vendor Serial Number:** Serial number provided by vendor.

**Vendor Revision Number:** Revision level for part number provided by vendor.

**Vendor Manufacturing Date:** The vendor's manufacturing date.

**Switch 1 Module x, Found 6 Ports SFP Plus 10G Daughter Board**

**Switch 1 10G's Module x** (The xth 10-Giga Module daughter board of switch 1).

**Switch 1 Interface = y..... SFP+**(The yth 10-Giga information of switch 1).

**10 Gigabit Ethernet Compliance Codes:** Transceiver's compliance codes.

**Vendor Name:** The SFP transceiver vendor name shall be the full name of the corporation, a commonly accepted abbreviation of the name of the corporation, the SCSI company code for the corporation, or the stock exchange code for the corporation.

**Vendor Part Number:** Part number provided by SFP transceiver vendor.

**Vendor Serial Number:** Serial number provided by vendor.

**Vendor Revision Number:** Revision level for part number provided by vendor.

**Vendor Manufacturing Date:** The vendor's manufacturing date.

**Switch 1 Module x, Found 4 Ports SFP Plus 10G Daughter Board**

**Switch 1 10G's Module x** (The xth 10-Giga Module daughter board of switch 1).

**Switch 1 Interface = y..... SFP+**(The yth 10-Giga information of switch 1).

**10 Gigabit Ethernet Compliance Codes:** Transceiver's compliance codes.

**Vendor Name:** The SFP transceiver vendor name shall be the full name of the corporation, a commonly accepted abbreviation of the name of the corporation, the SCSI company code for the corporation, or the stock exchange code for the corporation.

**Vendor Part Number:** Part number provided by SFP transceiver vendor.

**Vendor Serial Number:** Serial number provided by vendor.

**Vendor Revision Number:** Revision level for part number provided by vendor.

**Vendor Manufacturing Date:** The vendor's manufacturing date.

**Switch 1 Module x, Found 4 Ports SFP Plus 10G Daughter Board**

**Switch 1 10G's Module x** (The xth 10-Giga Module daughter board of switch 1).

**Switch 1 Interface = y..... SFP+**(The yth 10-Giga information of switch 1).

**10 Gigabit Ethernet Compliance Codes:** Transceiver's compliance codes.

**Vendor Name:** The SFP transceiver vendor name shall be the full name of the corporation, a commonly accepted abbreviation of the name of the corporation, the SCSI company code for the corporation, or the stock exchange code for the corporation.

**Vendor Part Number:** Part number provided by SFP transceiver vendor.

**Vendor Serial Number:** Serial number provided by vendor.

**Vendor Revision Number:** Revision level for part number provided by vendor.

**Vendor Manufacturing Date:** The vendor's manufacturing date.

**Now temperature:** The temperature of switch x.

**Fan 1 Status:** Status of Fan1. It could be active or inactive.

**Fan 2 Status:** Status of Fan2. It could be active or inactive.

**Additional Packages:** This displays the additional packages that are incorporated into this system.

**6.1.8 show version**

This command displays inventory information for the switch.

<b>Syntax</b>
<b>show version</b>

**Default Setting**

None



**Command Mode**

Privileged Exec

**Display Message****System Description:**Text used to identify the product name of this switch.**Machine Type:** Specifies the machine model as defined by the Vital Product Data.**Machine Model:** Specifies the machine model as defined by the Vital Product Data.**Serial Number:** The unique box serial number for this switch.**FRU Number:** The field replaceable unit number.**Part Number:** Manufacturing part number.**Maintenance Level:** Indicates hardware changes that are significant to software.**Manufacturer:** Manufacturer descriptor field.**Burned in MAC Address:** Universally assigned network address.**Software Version:** The release.version.revision number of the code currently running on the switch.**Operating System:** The operating system currently running on the switch.**Network Processing Device:** The type of the processor microcode.**Additional Packages:** This displays the additional packages incorporated into this system.**6.1.9 show loginsession**

This command displays current telnet and serial port connections to the switch.

**Syntax**

```
show loginsession
```

**Default Setting**

None

**Command Mode**

Privileged Exec

**Display Message****ID:** Login Session ID**User Name:** The name the user will use to login using the serial port or Telnet. A new user may be added to the switch by entering a name in a blank entry. The user name may be up to 8 characters, and is not case sensitive. Two users are included as the factory default, admin, and guest.**Connection From:** IP address of the telnet client machine or EIA-232 for the serial port connection.**Idle Time:** Time this session has been idle.**Session Time:** Total time this session has been connected.**Session Type:** Shows the type of session: telnet, serial or SSH.

## 6.2 Device Configuration Commands

### 6.2.1 Interface

#### 6.2.1.1 show interface status

This command displays the Port monitoring information for the system.

<b>Syntax</b>
---------------

<b>show interface status {&lt;slot/port&gt;   all}</b>
--

**<slot/port>** - is the desired interface number.

**all** - This parameter displays information for all interfaces.

#### Default Setting

None

#### Command Mode

Privileged Exec

#### Display Message

**Intf:** The physical slot and physical port.

**Type:** If not blank, this field indicates that this port is a special type of port. The possible values are:

**Source** - This port is a monitoring port.

**PC Mbr** - This port is a member of a port-channel (LAG).

**Dest** - This port is a probe port.

**Admin Mode:** Selects the Port control administration state. The port must be enabled in order for it to be allowed into the network. – It may be enabled or disabled. The factory default is enabled.

**Physical Mode:** Selects the desired port speed and duplex mode. If auto-negotiation support is selected, then the duplex mode and speed will be set from the auto-negotiation process. Note that the port's maximum capability (full duplex -100M) will be advertised. Otherwise, this object will determine the port's duplex mode and transmission rate. The factory default is Auto.

**Physical Status:** Indicates the port speed and duplex mode.

**Link Status:** Indicates whether the Link is up or down.

**Link Trap:** This object determines whether to send a trap when link status changes. The factory default is enabled.

**LACP Mode:** Displays whether LACP is enabled or disabled on this port.

**Flow Mode:** Displays flow control mode.

**Capabilities Status:** Displays interface capabilities.

### 6.2.1.2 show interface status description

This command displays the interface information for the system.

<b>Syntax</b>
---------------

<b>show interface status description &lt;slot/port&gt;</b>
--

**<slot/port>** - is the desired interface number.

#### Default Setting

None

#### Command Mode

Privileged Exec

#### Display Message

**Interface:** The physical slot and physical port.

**if Index:** Indicates the if Index of the interface table entry associated with this port.

**Description:** Description string attached to a port. It can be of up to 64 characters in length.

**MAC Address:** Displays the physical address of the specified interface.

**Bit Offset Value:** Displays the bit offset value which corresponds to the port when the MIB object type PortList is used to manage in SNMP.

**MDI Status:** The current status for MDI/MDIX.

**MDI Config:** The user config for MDI/MDIX.

### 6.2.1.3 show interface counters

This command displays a summary of statistics for a specific interface or all interfaces.

<b>Syntax</b>
---------------

<b>show interface counters {&lt;slot/port&gt;   all}</b>
--

**<slot/port>** - is the desired interface number.

**all** - This command displays statistics information for all interfaces.

### Default Setting

None

### Command Mode

Privileged Exec

### Display Message

The display parameters when the argument is '<slot/port>' are as follows:

**Packets Received Without Error:** The total number of packets (including broadcast packets and multicast packets) received by the processor.

**Packets Received With Error:** The number of inbound packets that contained errors preventing them from being deliverable to a higher-layer protocol.

**Broadcast Packets Received:** The total number of packets received that were directed to the broadcast address. Note that this does not include multicast packets.

**Packets Transmitted Without Error:** The total number of packets transmitted out of the interface.

**Transmit Packets Errors:** The number of outbound packets that could not be transmitted because of errors.

**Collisions Frames:** The best estimate of the total number of collisions on this Ethernet segment.

**Time Since Counters Last Cleared:** The elapsed time, in days, hours, minutes, and seconds since the statistics for this port were last cleared.

The display parameters when the argument is 'all' are as follows:

**Interface:** The physical slot and physical port or the logical slot and logical port.

**Summary:** The summation of the statistics of all ports.

**Packets Received Without Error:** The total number of packets (including broadcast packets and multicast packets) received.

**Packets Received With Error:** The number of inbound packets that contained errors preventing them from being deliverable to a higher-layer protocol.

**Broadcast Packets Received:** The total number of packets received that were directed to the broadcast address. Note that this does not include multicast packets.

**Packets Transmitted Without Error:** The total number of packets transmitted.

**Transmit Packets Errors:** The number of outbound packets that could not be transmitted because of errors.

**Collisions Frames:** The best estimate of the total number of collisions on this Ethernet segment.

This command displays detailed statistics for a specific port or for all CPU traffic based upon the argument.

**Syntax**

```
show interface counters detailed {<slot/port> | switchport}
```

**<slot/port>** - is the desired interface number.

**switchport** - This parameter specifies whole switch or all interfaces.

**Default Setting**

None

**Command Mode**

Privileged Exec

**Display Message**

The display parameters when the argument is ' <slot/port>' are as follows:

**Total Packets Received (Octets):** The total number of octets of data (including those in bad packets) received on the network (excluding framing bits but including FCS octets). This object can be used as a reasonable estimate of Ethernet utilization. If greater precision is desired, the etherStatsPkts and etherStatsOctets objects should be sampled before and after a common interval. The result of this equation is the value Utilization which is the percent utilization of the Ethernet segment on a scale of 0 to 100 percent.

**Packets Received 64 Octets:** The total number of packets (including bad packets) received that were 64 octets in length (excluding framing bits but including FCS octets).

**Packets Received 65-127 Octets:** The total number of packets (including bad packets) received that were between 65 and 127 octets in length inclusive (excluding framing bits but including FCS octets).

**Packets Received 128-255 Octets:** The total number of packets (including bad packets) received that were between 128 and 255 octets in length inclusive (excluding framing bits but including FCS octets).

**Packets Received 256-511 Octets:** The total number of packets (including bad packets) received that were between 256 and 511 octets in length inclusive (excluding framing bits but including FCS octets).

**Packets Received 512-1023 Octets:** The total number of packets (including bad packets) received that were between 512 and 1023 octets in length inclusive (excluding framing bits but including FCS octets).

**Packets Received 1024-1518 Octets:** The total number of packets (including bad packets) received that were between 1024 and 1518 octets in length inclusive (excluding framing bits but including FCS octets).

**Packets Received > 1522 Octets:** The total number of packets received that were longer than 1522 octets (excluding framing bits, but including FCS octets) and were otherwise well formed.

**Packets RX and TX 64 Octets:** The total number of packets (including bad packets) received that were 64 octets in length (excluding framing bits but including FCS octets).

**Packets RX and TX 65-127 Octets:** The total number of packets (including bad packets) received that were between 65 and 127 octets in length inclusive (excluding framing bits but including FCS octets).

**Packets RX and TX 128-255 Octets:** The total number of packets (including bad packets) received that were between 128 and 255 octets in length inclusive (excluding framing bits but including FCS octets).

**Packets RX and TX 256-511 Octets:** The total number of packets (including bad packets) received that were between 256 and 511 octets in length inclusive (excluding framing bits but including FCS octets).

**Packets RX and TX 512-1023 Octets:** The total number of packets (including bad packets) received that were between 512 and 1023 octets in length inclusive (excluding framing bits but including FCS octets).

**Packets RX and TX 1024-1518 Octets:** The total number of packets (including bad packets) received that were between 1024 and 1518 octets in length inclusive (excluding framing bits but including FCS octets).

**Packets RX and TX 1519-1522 Octets:** The total number of packets (including bad packets) received that were between 1519 and 1522 octets in length inclusive (excluding framing bits but including FCS octets).

**Packets RX and TX 1523-2047 Octets:** The total number of packets (including bad packets) received that were between 1523 and 2047 octets in length inclusive (excluding framing bits but including FCS octets).

**Packets RX and TX 2048-4095 Octets:** The total number of packets (including bad packets) received that were between 2048 and 4095 octets in length inclusive (excluding framing bits but including FCS octets).

**Packets RX and TX 4096-9216 Octets:** The total number of packets (including bad packets) received that were between 4096 and 9216 octets in length inclusive (excluding framing bits but including FCS octets).

#### **Total Packets Received Without Errors**

**Unicast Packets Received:** The number of subnetwork-unicast packets delivered to a higher-layer protocol.

**Multicast Packets Received:** The total number of good packets received that were directed to a multicast address. Note that this number does not include packets directed to the broadcast address.

**Broadcast Packets Received:** The total number of good packets received that were directed to the broadcast address. Note that this does not include multicast packets.

#### **Total Packets Received with MAC Errors**

**Jabbers Received:** The total number of packets received that were longer than 1518 octets (excluding framing bits, but including FCS octets), and had either a bad FCS with an integral number of octets (FCS Error) or a bad FCS with a non-integral number of octets (Alignment Error). Note that this definition of jabber is different than the definition in IEEE-802.3 section 8.2.1.5 (10BASE5) and section 10.3.1.4 (10BASE2). These documents define jabber as the condition where any packet exceeds 20 ms. The allowed range to detect jabber is between 20 ms and 150 ms.

**Undersize Received:** The total number of packets received that were less than 64 octets in length with GOOD CRC(excluding framing bits but including FCS octets).

**Fragments Received:** The total number of packets received that were less than 64 octets in length with ERROR CRC(excluding framing bits but including FCS octets).

**Alignment Errors:** The total number of packets received that had a length (excluding framing bits, but including FCS octets) of between 64 and 1518 octets, inclusive, but had a bad FCS with a non-integral number of octets.

**FCS Errors:** The total number of packets received that had a length (excluding framing bits, but including FCS octets) of between 64 and 1518 octets, inclusive, but had a bad

FCS with an integral number of octets

**Overruns:** The total number of frames discarded as this port was overloaded with incoming packets, and could not keep up with the inflow.

#### **Total Packets Transmitted (Octets)**

**Packets Transmitted 64 Octets:** The total number of packets (including bad packets) received that were 64 octets in length (excluding framing bits but including FCS octets).

**Packets Transmitted 65-127 Octets:** The total number of packets (including bad packets) received that were between 65 and 127 octets in length inclusive (excluding framing bits but including FCS octets).

**Packets Transmitted 128-255 Octets:** The total number of packets (including bad packets) received that were between 128 and 255 octets in length inclusive (excluding framing bits but including FCS octets).

**Packets Transmitted 256-511 Octets:** The total number of packets (including bad packets) received that were between 256 and 511 octets in length inclusive (excluding framing bits but including FCS octets).

**Packets Transmitted 512-1023 Octets:** The total number of packets (including bad packets) received that were between 512 and 1023 octets in length inclusive (excluding framing bits but including FCS octets).

**Packets Transmitted 1024-1518 Octets:** The total number of packets (including bad packets) received that were between 1024 and 1518 octets in length inclusive (excluding framing bits but including FCS octets).

**Packets Transmitted 1519-1522 Octets:** The total number of packets (including bad packets) received that were between 1519 and 1522 octets in length inclusive (excluding framing bits but including FCS octets).

**Max Info:** The maximum size of the Info (non-MAC) field that this port will receive or transmit.

#### **Total Packets Transmitted Successfully**

**Unicast Packets Transmitted:** The total number of packets that higher-level protocols requested be transmitted to a subnetwork-unicast address, including those that were discarded or not sent.

**Multicast Packets Transmitted:** The total number of packets that higher-level protocols requested be transmitted to a Multicast address, including those that were discarded or not sent.

**Broadcast Packets Transmitted:** The total number of packets that higher-level protocols requested be transmitted to the Broadcast address, including those that were discarded or not sent.

#### **Total Transmit Errors**

**FCS Errors:** The total number of packets transmitted that had a length (excluding framing bits, but including FCS octets) of between 64 and 1518 octets, inclusive, but had a bad FCS with an integral number of octets

**Tx Oversized:** The total number of frames that exceeded the max permitted frame size. This counter has a max increment rate of 815 counts per sec. at 10 Mb/s.

**Underrun Errors:** The total number of frames discarded because the transmit FIFO buffer became empty during frame transmission.

#### **Total Transmitted Packets Discards**

**Single Collision Frames:** A count of the number of successfully transmitted frames on a particular interface for which transmission is inhibited by exactly one collision.

**Multiple Collision Frames:** A count of the number of successfully transmitted frames on

a particular interface for which transmission is inhibited by more than one collision.

**Excessive Collisions:** A count of frames for which transmission on a particular interface fails due to excessive collisions.

**GVRP PDUs Received:** The count of GVRP PDUs received in the GARP layer.

**GVRP PDUs Transmitted:** The count of GVRP PDUs transmitted from the GARP layer.

**GVRP Failed and Registrations:** The number of times attempted GVRP registrations could not be completed.

**GMRP PDUs received:** The count of GMRP PDUs received in the GARP layer.

**GMRP PDUs Transmitted:** The count of GMRP PDUs transmitted from the GARP layer.

**GMRP Failed Registrations:** The number of times attempted GMRP registrations could not be completed.

**STP BPDUs Transmitted:** Spanning Tree Protocol Bridge Protocol Data Units sent.

**STP BPDUs Received:** Spanning Tree Protocol Bridge Protocol Data Units received.

**RSTP BPDUs Transmitted:** Rapid Spanning Tree Protocol Bridge Protocol Data Units sent.

**RSTP BPDUs Received:** Rapid Spanning Tree Protocol Bridge Protocol Data Units received.

**MSTP BPDUs Transmitted:** Multiple Spanning Tree Protocol Bridge Protocol Data Units sent.

**MSTP BPDUs Received:** Multiple Spanning Tree Protocol Bridge Protocol Data Units received.

**EAPOL Frames Received:** The number of valid EAPOL frames of any type that have been received by this authenticator.

**EAPOL Frames Transmitted:** The number of EAPOL frames of any type that have been transmitted by this authenticator.

**Time Since Counters Last Cleared:** The elapsed time, in days, hours, minutes, and seconds since the statistics for this port were last cleared.

The display parameters when the argument is 'switchport' are as follows:

**Total Packets Received (Octets):** The total number of octets of data received by the processor (excluding framing bits but including FCS octets).

**Packets Received Without Error:** The total number of packets (including broadcast packets and multicast packets) received by the processor.

**Unicast Packets Received:** The number of subnetwork-unicast packets delivered to a higher-layer protocol.

**Multicast Packets Received:** The total number of packets received that were directed to a multicast address. Note that this number does not include packets directed to the broadcast address.

**Broadcast Packets Received:** The total number of packets received that were directed to the broadcast address. Note that this does not include multicast packets.

**Receive Packets Discarded:** The number of inbound packets which were chosen to be discarded even though no errors had been detected to prevent their being deliverable to a higher-layer protocol. A possible reason for discarding a packet could be to free up buffer space.

**Octets Transmitted:** The total number of octets transmitted out of the interface, including framing characters.

**Packets Transmitted without Errors:** The total number of packets transmitted out of the interface.



**Unicast Packets Transmitted:** The total number of packets that higher-level protocols requested be transmitted to a subnetwork-unicast address, including those that were discarded or not sent.

**Multicast Packets Transmitted:** The total number of packets that higher-level protocols requested be transmitted to a Multicast address, including those that were discarded or not sent.

**Broadcast Packets Transmitted:** The total number of packets that higher-level protocols requested be transmitted to the Broadcast address, including those that were discarded or not sent.

**Transmit Packets Discarded:** The number of outbound packets which were chosen to be discarded even though no errors had been detected to prevent their being deliverable to a higher-layer protocol. A possible reason for discarding a packet could be to free up buffer space.

**Most Address Entries Ever Used:** The highest number of Forwarding Database Address Table entries that have been learned by this switch since the most recent reboot.

**Address Entries Currently in Use:** The number of Learned and static entries in the Forwarding Database Address Table for this switch.

**Maximum VLAN Entries:** The maximum number of Virtual LANs (VLANs) allowed on this switch.

**Most VLAN Entries Ever Used:** The largest number of VLANs that have been active on this switch since the last reboot.

**Static VLAN Entries:** The number of presently active VLAN entries on this switch that have been created statically.

**Dynamic VLAN Entries:** The number of presently active VLAN entries on this switch that have been created by GVRP registration.

**VLAN Deletes:** The number of VLANs on this switch that have been created and then deleted since the last reboot.

**Time Since Counters Last Cleared:** The elapsed time, in days, hours, minutes, and seconds, since the statistics for this switch were last cleared.

#### 6.2.1.4 show interface switch

This command displays a summary of statistics for all CPU traffic.

<b>Syntax</b>
---------------

<b>show interface switch</b>
------------------------------

#### Default Setting

None

#### Command Mode

Privileged Exec

## Display Message

**Broadcast Packets Received:** The total number of packets received that were directed to the broadcast address. Note that this does not include multicast packets.

**Packets Received With Error:** The number of inbound packets that contained errors preventing them from being deliverable to a higher-layer protocol.

**Packets Transmitted Without Error:** The total number of packets transmitted out of the interface.

**Broadcast Packets Transmitted:** The total number of packets that higher-level protocols requested to be transmitted to the Broadcast address, including those that were discarded or not sent.

**Transmit Packet Errors:** The number of outbound packets that could not be transmitted because of errors.

**Address Entries Currently In Use:** The total number of Forwarding Database Address Table entries now active on the switch, including learned and static entries.

**VLAN Entries Currently In Use:** The number of VLAN entries presently occupying the VLAN table.

**Time Since Counters Last Cleared:** The elapsed time, in days, hours, minutes, and seconds since the statistics for this switch were last cleared.

### 6.2.1.5 interface

This command is used to enter Interface configuration mode.

<b>Syntax</b>
---------------

<b>interface &lt;slot/port&gt;</b>
------------------------------------

**<slot/port>** - is the desired interface number.

### Default Setting

None

### Command Mode

Global Config

### 6.2.1.6 speed-duplex

**Note:The 10-Giga Interface will not provide the following command**

This command is used to set the speed and duplex mode for the interface.

**Syntax**

```
speed-duplex {10 | 100} {full-duplex | half-duplex}
```

**100** - 100BASE-T

**10** - 10BASE-T

**full-duplex** - Full duplex

**half-duplex** - Half duplex

**Default Setting**

None

**Command Mode**

Interface Config

This command is used to set the speed and duplex mode for all interfaces.

**Syntax**

```
speed-duplex all {10 | 100} {full-duplex | half-duplex}
```

**100** - 100BASE-T

**10** - 10BASE-T

**full - duplex** - Full duplex

**half - duplex** - Half duplex

**all** - This command represents all interfaces.

**Default Setting**

None

**Command Mode**

Global Config

**6.2.1.7 negotiate**

**Note: The 10-Giga Interface will not provide the following command**

This command enables automatic negotiation on a port. The default value is enabled.

**Syntax**

```
negotiate
no negotiate
```

**no** - This command disables automatic negotiation on a port.

**Default Setting**

Enable

**Command Mode**

Interface Config

This command enables automatic negotiation on all interfaces. The default value is enabled.

**Syntax**

```
negotiate all
no negotiate all
```

**all** - This command represents all interfaces.

**no** - This command disables automatic negotiation on all interfaces.

**Default Setting**

Enable

**Command Mode**

Global Config

**6.2.1.8 capabilities**

**Note: The 10-Giga Interface will not provide the following command**

This command is used to set the capabilities on specific interface.

**Syntax**

```
capabilities {{10 | 100} {full-duplex | half-duplex}} | {1000 full-duplex }  
no capabilities {{10 | 100} {full-duplex | half-duplex}} | {1000 full-duplex }
```

**10** - 10BASE-T

**100** - 100BASE-T

**1000** - 1000BASE-T

**full-duplex** - Full duplex

**half-duplex** - Half duplex

**no** - This command removes the advertised capability with using parameter.

**Default Setting**

10 half-duplex, 10 full-duplex, 100 half-duplex, 100 full-duplex, and 1000 full-duplex

**Command Mode**

Interface Config

This command is used to set the capabilities on all interfaces.

**Syntax**

```
capabilities all {{10 | 100} {full-duplex | half-duplex}} | {1000 full-duplex }  
no capabilities all {{10 | 100} {full-duplex | half-duplex}} | {1000 full-duplex }
```

**10** - 10BASE-T

**100** - 100BASE-T

**1000** - 1000BASE-T

**full-duplex** - Full duplex

**half-duplex** - Half duplex

**all** - This command represents all interfaces.

**no** - This command removes the advertised capability with using parameter

**Default Setting**

10 half-duplex, 10 full-duplex, 100 half-duplex, 100 full-duplex, and 1000 full-duplex

**Command Mode**

Global Config

**6.2.1.9 storm-control flowcontrol**

This command enables 802.3x flow control for the switch.

**Note:** This command only applies to full-duplex mode ports.

**Syntax**

```
storm-control flowcontrol  
no storm-control flowcontrol
```

**no** - This command disables 802.3x flow control for the switch.

**Default Setting**

Disabled

**Command Mode**

Global Config

This command enables 802.3x flow control for the specific interface.

**Note:** This command only applies to full-duplex mode ports.

**Syntax**

```
storm-control flowcontrol  
no storm-control flowcontrol
```

**no** - This command disables 802.3x flow control for the specific interface.

**Default Setting**

Disabled

**Command Mode**

Interface Config

**6.2.1.10 shutdown**

This command is used to disable a port.

**Syntax**

```
shutdown  
no shutdown
```

**no** - This command enables a port.

**Default Setting**

Enabled

**Command Mode**

Interface Config

This command is used to disable all ports.

**Syntax**

```
shutdown all  
no shutdown all
```

**all** - This command represents all ports.

**no** - This command enables all ports.

**Default Setting**

Enabled

**Command Mode**

Global Config

### 6.2.1.11 description

This command is used to create an alpha-numeric description of the port.

#### Syntax

```
description <description>  
no description
```

**no** - This command removes the description of the port.

#### Default Setting

None

#### Command Mode

Interface Config

### 6.2.1.12 mdi

*Note: The 10-Giga Interface will not provide the following command*

This command is used to configure the physical port MDI/MDIX state.

#### Syntax

```
mdi {auto|across|normal}  
no mdi
```

**auto** - This type is auto selecting cable type.

**across** - This type is only allowed the Across-over cable.

**normal** - This type is only allowed the Normal cable.

**no** - This command restore the port mode to Auto.

#### Default Setting



Auto

**Command Mode**

Interface Config

**6.2.2 L2 MAC Address and Multicast Forwarding Database Tables****6.2.2.1 show mac-addr-table**

This command displays the forwarding database entries. If the command is entered with no parameter, the entire table is displayed. This is the same as entering the optional **all** parameter. Alternatively, the administrator can enter a MAC Address to display the table entry for the requested MAC address and all entries following the requested MAC address.

**Syntax**

```
show mac-addr-table [{<macaddr> |all}]
```

**<macaddr>** - enter a MAC Address to display the table entry for the requested MAC address.

**all** – this command displays the entire table.

**Default Setting**

None

**Command Mode**

Privileged Exec

**Display Message**

**Mac Address:** A unicast MAC address for which the switch has forwarding and/or filtering information. The format is 6 or 8 two-digit hexadecimal numbers that are separated by colons, for example 01:23:45:67:89:AB. In an IVL system the MAC address will be displayed as 8 bytes. In an SVL system, the MAC address will be displayed as 6 bytes. **Note: This software version only supports IVL systems.**

**Interface:** The port on which this L2 MAC address was learned.

**if Index:** This object indicates the if Index of the interface table entry associated with this port.

**Status:** The status of this entry.

The meanings of the values are:

**Static:** The value of the corresponding instance was added by the system or a user when a static MAC filter was defined. It cannot be relearned.

**Learned:** The value of the corresponding instance was learned by observing the source MAC addresses of incoming traffic, and is currently in use.

**Management:** The value of the corresponding instance (system MAC address) is also the

value of an existing instance of dot1dStaticAddress. It is identified with interface 3/1 and is currently used when enabling VLANs for routing.

**Self:** The value of the corresponding instance is the address of one of the switch's physical interfaces (the system's own MAC address).

**GMRP Learned:** The value of the corresponding instance was learned via GMRP and applies to Multicast.

**Other:** The value of the corresponding instance does not fall into one of the other categories.

### 6.2.2.2 show mac-addr-table count

This command displays the total forwarding database entries, the number of static and learning mac address, and the max address available on the switch.

<b>Syntax</b>
---------------

<b>show mac-addr-table count</b>
----------------------------------

#### Default Setting

None

#### Command Mode

Privileged Exec

#### Display Message

**Dynamic Address count:** The total learning mac addresses on the L2 MAC address Table.

**Static Address (User-defined) count:** The total user-defined addresses on the L2 MAC address Table.

**Total MAC Addresses in use:** This number of addresses are used on the L2 MAC address table.

**Total MAC Addresses available:** The switch supports max value on the L2 MAC address table.

### 6.2.2.3 show mac-addr-table interface

This command displays the forwarding database entries. The user can search FDB table by using interface number <slot/port>.

<b>Syntax</b>
---------------

```
show mac-addr-table interface <slot/port>
```

<slot/port> - Interface number.

#### Default Setting

None

#### Command Mode

Privileged Exec

#### Display Message

**Mac Address:** A unicast MAC address for which the switch has forwarding and/or filtering information. The format is 6 or 8 two-digit hexadecimal numbers that are separated by colons, for example 01:23:45:67:89:AB. In an IVL system the MAC address will be displayed as 8 bytes. In an SVL system, the MAC address will be displayed as 6 bytes. **Note: This software version only supports IVL systems.**

**VLAN ID:** The vlan id of that mac address.

**Status:** The status of this entry.

The meanings of the values are:

**Static:** The value of the corresponding instance was added by the system or a user when a static MAC filter was defined. It cannot be relearned.

**Learned:** The value of the corresponding instance was learned by observing the source MAC addresses of incoming traffic, and is currently in use.

**Management:** The value of the corresponding instance (system MAC address) is also the value of an existing instance of dot1dStaticAddress. It is identified with interface 3/1 and is currently used when enabling VLANs for routing.

**Self:** The value of the corresponding instance is the address of one of the switch's physical interfaces (the system's own MAC address).

**GMRP Learned:** The value of the corresponding instance was learned via GMRP and applies to Multicast.

**Other:** The value of the corresponding instance does not fall into one of the other categories.

#### 6.2.2.4 show mac-addr-table vlan

This command displays the forwarding database entries. The user can search FDB table by using vlan id.

#### Syntax

```
show mac-addr-table vlan <vlanid>
```

<vlanid> - VLAN ID (Range: 1 - 3965)

**Default Setting**

None

**Command Mode**

Privileged Exec

**Display Message**

**Mac Address:** A unicast MAC address for which the switch has forwarding and/or filtering information. The format is 6 or 8 two-digit hexadecimal numbers that are separated by colons, for example 01:23:45:67:89:AB. In an IVL system the MAC address will be displayed as 8 bytes. In an SVL system, the MAC address will be displayed as 6 bytes. **Note: This software version only supports IVL systems.**

**Interface:** The port on which this L2 MAC address was learned.

**Status:** The status of this entry.

The meanings of the values are:

**Static:** The value of the corresponding instance was added by the system or a user when a static MAC filter was defined. It cannot be relearned.

**Learned:** The value of the corresponding instance was learned by observing the source MAC addresses of incoming traffic, and is currently in use.

**Management:** The value of the corresponding instance (system MAC address) is also the value of an existing instance of dot1dStaticAddress. It is identified with interface 3/1 and is currently used when enabling VLANs for routing.

**Self:** The value of the corresponding instance is the address of one of the switch's physical interfaces (the system's own MAC address).

**GMRP Learned:** The value of the corresponding instance was learned via GMRP and applies to Multicast.

**Other:** The value of the corresponding instance does not fall into one of the other categories.

**6.2.2.5 show mac-address-table gmrp**

This command displays the GARP Multicast Registration Protocol (GMRP) entries in the Multicast Forwarding Database (MFDB) table.

**Syntax**

```
show mac-address-table gmrp
```

**Default Setting**

None

**Command Mode**

Privileged Exec

**Display Message**

**Mac Address:** A unicast MAC address for which the switch has forwarding and/or filtering information. The format is 6 or 8 two-digit hexadecimal numbers that are separated by colons, for example 01:23:45:67:89:AB. In an IVL system the MAC address will be displayed as 8 bytes. In an SVL system, the MAC address will be displayed as 6 bytes. **Note: This software version only supports IVL systems.**

**Type:** This displays the type of the entry. Static entries are those that are configured by the end user. Dynamic entries are added to the table as a result of a learning process or protocol.

**Description:** The text description of this multicast table entry.

**Interfaces:** The list of interfaces that are designated for forwarding (Fwd:) and filtering (Flt:).

### 6.2.2.6 show mac-address-table igmpsnooping

This command displays the IGMP Snooping entries in the Multicast Forwarding Database (MFDB) table.

<b>Syntax</b>
---------------

<b>show mac-address-table igmpsnooping</b>
--

#### Default Setting

None

#### Command Mode

Privileged Exec

#### Display Message

**Mac Address:** A unicast MAC address for which the switch has forwarding and/or filtering information. The format is 6 or 8 two-digit hexadecimal numbers that are separated by colons, for example 01:23:45:67:89:AB. In an IVL system the MAC address will be displayed as 8 bytes. In an SVL system, the MAC address will be displayed as 6 bytes. **Note: This software version only supports IVL systems.**

**Type:** This displays the type of the entry. Static entries are those that are configured by the end user. Dynamic entries are added to the table as a result of a learning process or protocol.

**Description:** The text description of this multicast table entry.

**Interfaces:** The list of interfaces that are designated for forwarding (Fwd:) and filtering (Flt:).

### 6.2.2.7 show mac-address-table multicast

This command displays the MFDB information. If the command is entered with no parameter, the entire table is displayed. This is the same as entering the *all* parameter. The user can display the table entry for one MAC Address by specifying the MAC address as an optional parameter.

**Syntax**

```
show mac-address-table multicast {<macaddr> <vlanid> | all }
```

**<macaddr>** - enter a MAC Address to display the table entry for the requested MAC address

**<vlanid>** - VLAN ID (Range: 1 - 3965)

**all** – This command displays the entire table.

**Default Setting**

None

**Command Mode**

Privileged Exec

**Display Message**

**Mac Address:** A unicast MAC address for which the switch has forwarding and/or filtering information. The format is 6 or 8 two-digit hexadecimal numbers that are separated by colons, for example 01:23:45:67:89:AB. In an IVL system the MAC address will be displayed as 8 bytes. In an SVL system, the MAC address will be displayed as 6 bytes. **Note: This software version only supports IVL systems.**

**Type:** This displays the type of the entry. Static entries are those that are configured by the end user. Dynamic entries are added to the table as a result of a learning process or protocol.

**Source:** The component that is responsible for this entry in the Multicast Forwarding Database. Possible values are IGMP Snooping, GMRP, and Static Filtering.

**Description:** The text description of this multicast table entry.

**Interfaces:** The list of interfaces that are designated for forwarding (Fwd:) and filtering (Flt:).

**Forwarding Interfaces:** The resultant forwarding list is derived from combining all the component's forwarding interfaces and removing the interfaces that are listed as the static filtering interfaces.

**6.2.2.8 show mac-address-table stats**

This command displays the MFDB statistics.

**Syntax**

```
show mac-address-table stats
```

**Default Setting**

None

**Command Mode**

Privileged Exec

**Display Message**

**Max MFDB Table Entries:** This displays the total number of entries that can possibly be in the MFDB.

**Most MFDB Entries Since Last Reset:** This displays the largest number of entries that have been present in the Multicast Forwarding Database table. This value is also known as the MFDB high-water mark.

**Current Entries:** This displays the current number of entries in the Multicast Forwarding Database table.

**6.2.2.9 show mac-address-table agetime**

This command displays the forwarding database address aging timeout.

**Syntax**

```
show mac-address-table agetime
```

**Default Setting**

None

**Command Mode**

Privileged Exec

**Display Message**

**Address Aging Timeout:** This displays the total number of seconds for Forwarding Database table.

**6.2.2.10 mac-address-table aging-time**

This command configures the forwarding database address aging timeout in seconds.

**Syntax**

```
mac-address-table aging-time <10-1000000>  
no mac-address-table aging-time
```

<10-1000000> - aging-time (Range: 10-1000000) in seconds

no - This command sets the forwarding database address aging timeout to 300 seconds.

**Default Setting**

300

**Command Mode**

Global Config

## 6.2.3 VLAN Management

### 6.2.3.1 show vlan

This command displays brief information on a list of all configured VLANs.

**Syntax**

```
show vlan
```

**Default Setting**

None

**Command Mode**

Privileged Exec

**Display Message**

**VLAN ID:** There is a VLAN Identifier (vlanid) associated with each VLAN. The range of the VLAN ID is 1 to 3965.

**VLAN Name:** A string associated with this VLAN as a convenience. It can be up to 16 alphanumeric characters, including blanks. The default is blank. VLAN ID 1 is always named `Default`. This field is optional.

**VLAN Type:** Type of VLAN, which can be Default, (VLAN ID = 1), can be static (one that is configured and permanently defined), or Dynamic (one that is created by GVRP registration).

**Interface(s):** Indicates by slot id and port number which port belongs to this VLAN.



### 6.2.3.2 show vlan id

This command displays detailed information, including interface information, for a specific VLAN.

#### Syntax

```
show vlan {id <vlanid> | name <vlaname>}
```

**<vlanid>** - VLAN ID (Range: 1 – 3965)

**<vlaname>** - vlan name (up to 16 alphanumeric characters)

#### Default Setting

None

#### Command Mode

Privileged Exec

#### Display Message

**VLAN ID:** There is a VLAN Identifier (VID) associated with each VLAN. The range of the VLAN ID is 1 to 3965.

**VLAN Name:** A string associated with this VLAN as a convenience. It can be up to 16 alphanumeric characters, including blanks. The default is blank. VLAN ID 1 is always named `Default`. This field is optional.

**VLAN Type:** Type of VLAN, which can be Default, (VLAN ID = 1), can be static (one that is configured and permanently defined), or Dynamic (one that is created by GVRP registration).

**Interface:** Indicates by slot id and port number which port is controlled by the fields on this line.

It is possible to set the parameters for all ports by using the selectors on the top line.

**Current:** Determines the degree of participation of this port in this VLAN. The permissible values are:

**Include:** This port is always a member of this VLAN. This is equivalent to registration fixed in the IEEE 802.1Q standard.

**Exclude:** This port is never a member of this VLAN. This is equivalent to registration forbidden in the IEEE 802.1Q standard.

**Autodetect:** Specifies to allow the port to be dynamically registered in this VLAN via GVRP. The port will not participate in this VLAN unless a join request is received on this port. This is equivalent to registration normal in the IEEE 802.1Q standard.

**Configured:** Determines the configured degree of participation of this port in this VLAN. The permissible values are:

**Include:** This port is always a member of this VLAN. This is equivalent to registration fixed in the IEEE 802.1Q standard.

**Exclude:** This port is never a member of this VLAN. This is equivalent to registration forbidden in the IEEE 802.1Q standard.

**Autodetect:** Specifies to allow the port to be dynamically registered in this VLAN via GVRP. The port will not participate in this VLAN unless a join request is received on this

port. This is equivalent to registration normal in the IEEE 802.1Q standard.

**Tagging:** Select the tagging behavior for this port in this VLAN.

**Tagged:** Specifies to transmit traffic for this VLAN as tagged frames.

**Untagged:** Specifies to transmit traffic for this VLAN as untagged frames.

### 6.2.3.3 show vlan association mac

This command displays the VLAN associated with a specific configured MAC address. If no MAC address is specified, the VLAN associations of all the configured MAC addresses are displayed.

#### Syntax

```
show vlan association mac [<macaddr>]
```

**<macaddr>** - enter a MAC Address to display the table entry for the requested MAC address.

#### Default Setting

None

#### Command Mode

Privileged Exec

#### Display Message

**MAC Address:** A unicast MAC address for which the switch has forwarding and/or filtering information. The format is 6 or 8 two-digit hexadecimal numbers that are separated by colons, for example 01:23:45:67:89:AB. In an IVL system the MAC address will be displayed as 8 bytes. In an SVL system, the MAC address will be displayed as 6 bytes. **Note: This software version only supports IVL systems.**

**VLAN ID:** There is a VLAN Identifier (VID) associated with each VLAN. The range of the VLAN ID is 1 to 3965.

### 6.2.3.4 show vlan association subnet

This command displays the VLAN associated with a specific configured IP-Address and net mask. If no IP Address and net mask are specified, the VLAN associations of all the configured IP-subnets are displayed.

#### Syntax

```
show vlan association subnet [<ipaddr> <netmask>]
```

<ipaddr> - The IP address.

<netmask> - The subnet mask.

#### Default Setting

None

#### Command Mode

Privileged Exec

#### Display Message

**IP Address:** The IP address assigned to each interface

**Net Mask:** The subnet mask.

**VLAN ID:** There is a VLAN Identifier (VID) associated with each VLAN. The range of the VLAN ID is 1 to 3965.

### 6.2.3.5 show protocol group

This command displays the Protocol-Based VLAN information for either the entire system, or for the indicated Group.

#### Syntax

```
show protocol group {<group-name> | all}
```

<group-name> - The group name of an entry in the Protocol-based VLAN table.

all – Displays the entire table.

#### Default Setting

None

#### Command Mode

Privileged Exec

#### Display Message

**Group Name:** This field displays the group name of an entry in the Protocol-based VLAN table.

**Group ID:** This field displays the group identifier of the protocol group.

**Protocol(s):** This field indicates the type of protocol(s) for this group.

**VLAN:** This field indicates the VLAN associated with this Protocol Group.

**Interface(s):** This field lists the slot/port interface(s) that are associated with this Protocol Group.

### 6.2.3.6 show interface switchport

This command displays VLAN port information.

#### Syntax

```
show interface switchport {<slot/port> | all}
```

**<slot/port>** - Interface number.  
**all** – Display the entire table.

#### Default Setting

None

#### Command Mode

Privileged Exec

#### Display Message

**Interface:** Indicates by slot id and port number which port is controlled by the fields on this line. It is possible to set the parameters for all ports by using the selectors on the top line.

**Port VLAN ID:** The VLAN ID that this port will assign to untagged frames or priority tagged frames received on this port. The value must be for an existing VLAN. The factory default is 1.

**Acceptable Frame Types:** Specifies the types of frames that may be received on this port. The options are 'VLAN only' and 'Admit All'. When set to 'VLAN only', untagged frames or priority tagged frames received on this port are discarded. When set to 'Admit All', untagged frames or priority tagged frames received on this port are accepted and assigned the value of the Port VLAN ID for this port. With either option, VLAN tagged frames are forwarded in accordance to the 802.1Q VLAN specification.

**Ingress Filtering:** May be enabled or disabled. When enabled, the frame is discarded if this port is not a member of the VLAN with which this frame is associated. In a tagged frame, the VLAN is identified by the VLAN ID in the tag. In an untagged frame, the VLAN is the Port VLAN ID specified for the port that received this frame. When disabled, all frames are forwarded in accordance with the 802.1Q VLAN bridge specification. The factory default is disabled.

**GVRP:** May be enabled or disabled.

**Default Priority:** The 802.1p priority assigned to untagged packets arriving on the port.

### 6.2.3.7 vlan database

This command is used to enter VLAN Interface configuration mode

**Syntax**

```
vlan database
```

**Default Setting**

None

**Command Mode**

Global Config

**6.2.3.8 vlan**

This command creates a new VLAN and assigns it an ID. The ID is a valid VLAN identification number (ID 1 is reserved for the default VLAN). VLAN range is 2-3965.

**Syntax**

```
vlan <vlanid> [<name>]  
no vlan <vlanid>
```

**<vlanid>** - VLAN ID (Range: 2 –3965).

**<name>** - Configure an optional VLAN Name (a character string of 1 to 32 alphanumeric characters).

**no** - This command deletes an existing VLAN. The ID is a valid VLAN identification number (ID 1 is reserved for the default VLAN). VLAN range is 2-3965.

**Default Setting**

None

**Command Mode**

VLAN database

**6.2.3.9 vlan name**

This command changes the name of a VLAN. The name is an alphanumeric string of up to 32 characters, and the ID is a valid VLAN identification number. ID range is 1- 3965.

**Syntax**

```
vlan name <vlanid> <newname>  
no vlan name <vlanid>
```

**<vlanid>** - VLAN ID (Range: 1 –3965).

**<newname>** - Configure a new VLAN Name (up to 16 alphanumeric characters).

**no** - This command sets the name of a VLAN to a blank string. The VLAN ID is a valid VLAN identification number. ID range is 1-3965.

**Default Setting**

The name for VLAN ID 1 is always Default. The name for other VLANs is defaulted to a blank string.

**Command Mode**

VLAN database

**6.2.3.10 vlan association mac**

This command associates a MAC address to a VLAN.

**Syntax**

```
vlan association mac <macaddr> <vlanid>  
no vlan association mac <macaddr>
```

**<macaddr>** - enter a MAC Address to display the table entry for the requested MAC address.

**<vlanid>** - VLAN identification number. ID range is 1-3965.

**no** - This command removes the association of a MAC address to a VLAN.

**Default Setting**

None

**Command Mode**

VLAN database

**6.2.3.11 vlan association subnet**

This command removes the association of a MAC address to a VLAN.

**Syntax**

```
vlan association subnet <ipaddr> <netmask> <vlanid>  
no vlan association subnet <ipaddr> <netmask>
```

**<ipaddr>** - The IP address.

**<netmask>** - The subnet mask.

**<vlanid>** - VLAN identification number. ID range is 1-3965.

**no** - This command removes association of a specific IP-subnet to a VLAN.

**Default Setting**

None

**Command Mode**

VLAN database

**6.2.3.12 vlan makestatic**

This command changes a dynamically created VLAN (one that is created by GVRP registration) to a static VLAN (one that is permanently configured and defined). The ID is a valid VLAN identification number. VLAN range is 2-3965.

**Syntax**

```
vlan makestatic <vlanid>
```

**<vlanid>** - VLAN ID (Range: 2 –3965).

**Default Setting**

None

**Command Mode**

VLAN database

**6.2.3.13 protocol group**

This command attaches a <vlanid> to the protocol-based VLAN identified by <group-name>. A

group may only be associated with one VLAN at a time, however the VLAN association can be changed.

**Syntax**

```
protocol group <group-name> <vlanid>  
no protocol group <group-name> <vlanid>
```

**<vlanid>** - VLAN ID (Range: 1 –3965).

**<group-name>** - a VLAN Group Name (a character string of 1 to 16 characters).

**no** - This command removes the <vlanid> from this protocol-based VLAN group that is identified by this <group-name>.

**Default Setting**

None

**Command Mode**

VLAN database

**6.2.3.14 switchport acceptable-frame-type**

This command sets the frame acceptance mode per interface. For VLAN Only mode, untagged frames or priority frames received on this interface are discarded. For Admit All mode, untagged frames or priority frames received on this interface are accepted and assigned the value of the interface VLAN ID for this port. With either option, VLAN tagged frames are forwarded in accordance with the IEEE 802.1Q VLAN Specification.

**Syntax**

```
switchport acceptable-frame-type {tagged | all}  
no switchport acceptable-frame-type {tagged | all}
```

**tagged** - VLAN only mode.

**all** - Admit all mode.

**no** - This command sets the frame acceptance mode per interface to **Admit All**. For Admit All mode, untagged frames or priority frames received on this interface are accepted and assigned the value of the interface VLAN ID for this port. With either option, VLAN tagged frames are forwarded in accordance with the IEEE 802.1Q VLAN Specification.

**Default Setting**

Admit all



**Command Mode**

Interface Config

This command sets the frame acceptance mode for all interfaces. For VLAN Only mode, untagged frames or priority frames received on this interface are discarded. For Admit All mode, untagged frames or priority frames received on this interface are accepted and assigned the value of the interface VLAN ID for this port. With either option, VLAN tagged frames are forwarded in accordance with the IEEE 802.1Q VLAN Specification.

**Syntax**

```
switchport acceptable-frame-type all {tagged | all}
no switchport acceptable-frame-type all {tagged | all}
```

**tagged** - VLAN only mode.

**all** – One is for Admit all mode. The other one is for all interfaces.

**no** - This command sets the frame acceptance mode for all interfaces to **Admit All**. For Admit All mode, untagged frames or priority frames received on this interface are accepted and assigned the value of the interface VLAN ID for this port. With either option, VLAN tagged frames are forwarded in accordance with the IEEE 802.1Q VLAN Specification.

**Default Setting**

Admit all

**Command Mode**

Global Config

**6.2.3.15 switchport ingress-filtering**

This command enables ingress filtering. If ingress filtering is disabled, frames received with VLAN IDs that do not match the VLAN membership of the receiving interface are admitted and forwarded to ports that are members of that VLAN.

**Syntax**

```
switchport ingress-filtering
```

**no switchport ingress-filtering**

**no** - This command disables ingress filtering. If ingress filtering is disabled, frames received with VLAN IDs that do not match the VLAN membership of the receiving interface are admitted and forwarded to ports that are members of that VLAN.

**Default Setting**

Disabled

**Command Mode**

Interface Config

This command enables ingress filtering for all ports. If ingress filtering is disabled, frames received with VLAN IDs that do not match the VLAN membership of the receiving interface are admitted and forwarded to ports that are members of that VLAN.

**Syntax**

```
switchport ingress-filtering all
no switchport ingress-filtering all
```

**all** - All interfaces.

**no** - This command disables ingress filtering for all ports. If ingress filtering is disabled, frames received with VLAN IDs that do not match the VLAN membership of the receiving interface are admitted and forwarded to ports that are members of that VLAN.

**Default Setting**

Disabled

**Command Mode**

Global Config

**6.2.3.16 switchport native vlan**

This command changes the VLAN ID per interface.

**Syntax**

```
switchport native vlan <vlanid>  
no switchport native vlan <vlanid>
```

**<vlanid>** - VLAN ID (Range: 1 –3965).

**no** - This command sets the VLAN ID per interface to 1.

**Default Setting**

1

**Command Mode**

Interface Config

This command changes the VLAN ID for all interfaces.

**Syntax**

```
switchport native vlan all <vlanid>
```

**<vlanid>** - VLAN ID (Range: 1 –3965).

**all** - All interfaces.

**no** - This command sets the VLAN ID for all interfaces to 1.

**Default Setting**

1

**Command Mode**

Global Config

**6.2.3.17 switchport allowed vlan**

This command configures the degree of participation for a specific interface in a VLAN. The ID is a valid VLAN identification number, and the interface is a valid interface number.

**Syntax**

```
switchport allowed vlan {add [tagged | untagged] | remove} <vlanid>
```

**<vlanid>** - VLAN ID (Range: 1 –3965).

**add** - The interface is always a member of this VLAN. This is equivalent to registration fixed.

**tagged** - All frames transmitted for this VLAN will be tagged.

**untagged** - All frames transmitted for this VLAN will be untagged.

**remove** - The interface is removed from the member of this VLAN. This is equivalent to registration forbidden.

**Default Setting**

None

**Command Mode**

Interface Config

This command configures the degree of participation for all interfaces in a VLAN. The ID is a valid VLAN identification number.

**Syntax**

```
switchport allowed vlan {add {tagged | untagged} | remove} all <vlanid>
```

**<vlanid>** - VLAN ID (Range: 1 –3965).

**all** - All interfaces.

**add** - The interface is always a member of this VLAN. This is equivalent to registration fixed.

**tagged** - all frames transmitted for this VLAN will be tagged.

**untagged** - all frames transmitted for this VLAN will be untagged.

**remove** - The interface is removed from the member of this VLAN. This is equivalent to registration forbidden.

**Default Setting**

None

**Command Mode**

Global Config

### 6.2.3.18 switchport tagging

This command configures the tagging behavior for a specific interface in a VLAN to enable. If tagging is enabled, traffic is transmitted as tagged frames. If tagging is disabled, traffic is transmitted as untagged frames. The ID is a valid VLAN identification number.

#### Syntax

```
switchport tagging <vlanid>  
no switchport tagging <vlanid>
```

**<vlanid>** - VLAN ID (Range: 1 –3965).

**no** - This command configures the tagging behavior for a specific interface in a VLAN to disabled. If tagging is disabled, traffic is transmitted as untagged frames. The ID is a valid VLAN identification number.

#### Default Setting

Disabled

#### Command Mode

Interface Config

This command configures the tagging behavior for all interfaces in a VLAN to be enabled. If tagging is enabled, traffic is transmitted as tagged frames. If tagging is disabled, traffic is transmitted as untagged frames. The ID is a valid VLAN identification number.

#### Syntax

```
switchport tagging all <vlanid>
```

**<vlanid>** - VLAN ID (Range: 1 –3965).

**all** - All interfaces

**no** - This command configures the tagging behavior for all interfaces in a VLAN to disabled. If tagging is disabled, traffic is transmitted as untagged frames. The ID is a valid VLAN identification number.

#### Default Setting

Disabled

**Command Mode**

Global Config

**6.2.3.19 switchport priority**

This command configures the default 802.1p port priority assigned for untagged packets for a specific interface.

**Syntax**

```
switchport priority <0-7>
```

<0-7> - The range for the priority is 0 - 7.

**Default Setting**

0

**Command Mode**

Interface Config

This command configures the port priority assigned for untagged packets for all ports presently plugged into the device. Any subsequent per port configuration will override this configuration setting.

**Syntax**

```
switchport priority all <0-7>
```

<0-7> - The range for the priority is 0-7.

all – All interfaces

**Default Setting**

0

**Command Mode**

Global Config

**6.2.3.20 switchport protocol group**

This command adds the physical <slot/port> interface to the protocol-based VLAN identified by <group-name>. A group may have more than one interface associated with it. Each interface and protocol combination can only be associated with one group. If adding an interface to a group causes any conflicts with protocols currently associated with the group, this command will fail, and the interface(s) will not be added to the group.

**Syntax**

```
switchport protocol group <group-name>  
no switchport protocol group <group-name>
```

<group-name> - a VLAN Group Name (a character string of 1 to 16 characters).

**no** - This command removes the *interface* from this protocol-based VLAN group that is identified by this <group-name>.

**Default Setting**

None

**Command Mode**

Interface Config

This command adds a protocol-based VLAN group to the system. The <group-name> is a character string of 1 to 16 characters. When it is created, the protocol group will be assigned a unique number that will be used to identify the group in subsequent commands.

**Syntax**

```
switchport protocol group <group-name>  
no switchport protocol group <group-name>
```

**<group-name>** - a VLAN Group Name (a character string of 1 to 16 characters).

**no** - This command removes the protocol-based VLAN group that is identified by this <group-name>.

**Default Setting**

None

**Command Mode**

Global Config

This command adds all physical interfaces to the protocol-based VLAN identified by <group-name>. A group may have more than one interface associated with it. Each interface and protocol combination can only be associated with one group. If adding an interface to a group causes any conflicts with protocols currently associated with the group, this command will fail, and the interface(s) will not be added to the group.

**Syntax**

```
switchport protocol group all <group-name>  
no switchport protocol group all <group-name>
```

**<group-name>** - a VLAN Group Name (a character string of 1 to 16 characters).

**all** - All interfaces.

**no** - This command removes all interfaces from this protocol-based VLAN group that is identified by this <group-name>.

**Default Setting**

None

**Command Mode**

Global Config



This command adds the <protocol> to the protocol-based VLAN identified by <group-name>. A group may have more than one protocol associated with it. Each interface and protocol combination can only be associated with one group. If adding a protocol to a group causes any conflicts with interfaces currently associated with the group, this command will fail, and the protocol will not be added to the group. The possible values for protocol are *ip*, *arp*, and *ipx*.

**Syntax**

```
switchport protocol group add protocol <group-name> {ip | arp | ipx}
no switchport protocol group add protocol <group-name> {ip | arp | ipx}
```

**<group-name>** - a VLAN Group Name (a character string of 1 to 16 characters).

**ip** - IP protocol.

**arp** - ARP protocol.

**ipx** - IPX protocol.

**no** - This command removes the <protocol> from this protocol-based VLAN group that is identified by this <group-name>. The possible values for protocol are *ip*, *arp*, and *ipx*.

**Default Setting**

None

**Command Mode**

Global Config

**6.2.3.21 switchport forbidden vlan**

This command used to configure forbidden VLANs.

**Syntax**

```
switchport forbidden vlan {add | remove} <vlanid>
no switchport forbidden
```

**<vlanid>** - VLAN ID (Range: 1 –3965).

**add** - VLAN ID to add.

**remove** - VLAN ID to remove.

**no** - Remove the list of forbidden VLANs.

**Default Setting**

None

**Command Mode**

Interface Config

**6.2.4 Double VLAN commands****6.2.4.1 show dvlan-tunnel/ dot1q-tunnel**

This command is used without the optional parameters to display all interfaces enabled for Double VLAN Tunneling. Use the optional parameters to display detailed information about Double VLAN Tunneling for the specified interface or all interfaces.

**Syntax**

```
show {dot1q-tunnel|dvlan-tunnel} [interface {<slot/port>|all}]
```

**Default Setting**

None

**Command Mode**

Privileged Exec

**Display Message**

**Interfaces Enabled for DVLAN Tunneling:** Valid interface(s) support(s) DVLAN Tunneling.

**When using 'show {dot1q-tunnel|dvlan-tunnel} interface':**

**Interface:** Valid slot and port number separated by forward slashes.

**Mode:** This field specifies the administrative mode through which Double VLAN Tunneling can be enabled or disabled. The default value for this field is disabled.

**EtherType** This field represents a 2-byte hex EtherType to be used as the first 16 bits of the DVLAN tunnel. There are three different EtherType tags. The first is 802.1Q, which represents the commonly used value of 0x8100. The second is vMAN, which represents the commonly used value of 0x88A8. If EtherType is not one of these two values, then it is a custom tunnel value, representing any value in the range of 0 to 65535.

**6.2.4.2 switchport dvlan-tunnel/ dot1q-tunnel ethertype**

This command configures the ether-type for all interfaces. The ether-type may have the values of *802.1Q*, *vMAN*, or *custom*. If the ether-type has a value of *custom*, the optional value of the custom ether type must be set to a value from 0 to 65535.

**Syntax**

```
switchport {dvlan-tunnel | dot1q-tunnel } ethertype {802.1Q|custom <0-65535>|vman}
```

**Default Setting**

Vman

**Command Mode**

Global Config

**6.2.4.3 switchport dvlan-tunnel/ dot1q-tunnel**

This command is used to enable Double VLAN Tunneling on the specified interface.

**Syntax**

```
switchport {dvlan-tunnel|dot1q-tunnel}  
no switchport {dvlan-tunnel|dot1q-tunnel}
```

**Default Setting**

Disable

**Command Mode**

Interface Config

This command enables enable Double VLAN Tunneling for all ports.

**Syntax**

```
switchport {dvlan-tunnel|dot1q-tunnel} all  
no switchport {dvlan-tunnel|dot1q-tunnel} all
```

**all** - All interfaces.

**no** - This command disables enable Double VLAN Tunneling for all ports.

**Default Setting**

Disabled

**Command Mode**

Global Config

## 6.2.5 GVRP and Bridge Extension

### 6.2.5.1 show bridge-ext

This command displays Generic Attributes Registration Protocol (GARP) information.

<b>Syntax</b>
---------------

<code>show bridge-ext</code>
------------------------------

#### Default Setting

None

#### Command Mode

Privileged Exec

#### Display Message

**GMRP Admin Mode:** This displays the administrative mode of GARP Multicast Registration Protocol (GMRP) for the system.

**GVRP Admin Mode:** This displays the administrative mode of GARP VLAN Registration Protocol (GVRP) for the system.

### 6.2.5.2 show gvrp configuration

This command displays Generic Attributes Registration Protocol (GARP) information for one or all interfaces.

<b>Syntax</b>
---------------

<code>show gvrp configuration {&lt;slot/port&gt;   all}</code>
--

**<slot/port>** - An interface number.

**all** - All interfaces.

**Default Setting**

None

**Command Mode**

Privileged Exec

**Display Message**

**Interface:** This displays the slot/port of the interface that this row in the table describes.

**Join Timer:** Specifies the interval between the transmission of GARP PDUs registering (or re-registering) membership for an attribute. Current attributes are a VLAN or multicast group. There is an instance of this timer on a per-Port, per-GARP participant basis. Permissible values are 10 to 100 centiseconds (0.1 to 1.0 seconds). The factory default is 20 centiseconds (0.2 seconds). The finest granularity of specification is 1 centisecond (0.01 seconds).

**Leave Timer:** Specifies the period of time to wait after receiving an unregister request for an attribute before deleting the attribute. Current attributes are a VLAN or multicast group. This may be considered a buffer time for another station to assert registration for the same attribute in order to maintain uninterrupted service. There is an instance of this timer on a per-Port, per-GARP participant basis. Permissible values are 20 to 600 centiseconds (0.2 to 6.0 seconds). The factory default is 60 centiseconds (0.6 seconds). The finest granularity of specification is 1 centisecond (0.01 seconds).

**LeaveAll Timer:** This Leave All Time controls how frequently LeaveAll PDUs are generated. A LeaveAll PDU indicates that all registrations will shortly be deregistered. Participants will need to rejoin in order to maintain registration. There is an instance of this timer on a per-Port, per-GARP participant basis. The Leave All Period Timer is set to a random value in the range of LeaveAll- Time to 1.5\*LeaveAllTime. Permissible values are 200 to 6000 centiseconds (2 to 60 seconds). The factory default is 1000 centiseconds (10 seconds). The finest granularity of specification is 1 centisecond (0.01 seconds).

**Port GVRP Mode:** Indicates the GVRP administrative mode for the port. It may be enabled or disabled. If this parameter is disabled, Join Time, Leave Time, and Leave All Time have no effect. The factory default is disabled.

**6.2.5.3 show gmrp configuration**

This command displays Generic Attributes Registration Protocol (GARP) information for one or All interfaces.

**Syntax**

```
show gmrp configuration {<slot/port> | all}
```

**<slot/port>** - An interface number.

**all** - All interfaces.

**Default Setting**

None

**Command Mode**

Privileged Exec

**Display Message**

**Interface:** This displays the slot/port of the interface that this row in the table describes.

**Join Timer:** Specifies the interval between the transmission of GARP PDUs registering (or re-registering) membership for an attribute. Current attributes are a VLAN or multicast group. There is an instance of this timer on a per-Port, per-GARP participant basis. Permissible values are 10 to 100 centiseconds (0.1 to 1.0 seconds). The factory default is 20 centiseconds (0.2 seconds). The finest granularity of specification is 1 centisecond (0.01 seconds).

**Leave Timer:** Specifies the period of time to wait after receiving an unregister request for an attribute before deleting the attribute. Current attributes are a VLAN or multicast group. This may be considered a buffer time for another station to assert registration for the same attribute in order to maintain uninterrupted service. There is an instance of this timer on a per-Port, per-GARP participant basis. Permissible values are 20 to 600 centiseconds (0.2 to 6.0 seconds). The factory default is 60 centiseconds (0.6 seconds). The finest granularity of specification is 1 centisecond (0.01 seconds).

**LeaveAll Timer:** This Leave All Time controls how frequently LeaveAll PDUs are generated. A LeaveAll PDU indicates that all registrations will shortly be deregistered. Participants will need to rejoin in order to maintain registration. There is an instance of this timer on a per-Port, per-GARP participant basis. The Leave All Period Timer is set to a random value in the range of LeaveAll- Time to 1.5\*LeaveAllTime. Permissible values are 200 to 6000 centiseconds (2 to 60 seconds). The factory default is 1000 centiseconds (10 seconds). The finest granularity of specification is 1 centisecond (0.01 seconds).

**Port GMRP Mode:** Indicates the GMRP administrative mode for the port. It may be enabled or disabled. If this parameter is disabled, Join Time, Leave Time, and Leave All Time have no effect. The factory default is disabled.

**6.2.5.4 show garp configuration**

This command displays GMRP and GVRP configuration information for one or all interfaces.

**Syntax**

```
show garp configuration {<slot/port> | all}
```

**<slot/port>** - An interface number.

**all** - All interfaces.

**Default Setting**

None

**Command Mode**

Privileged Exec

**Display Message****Interface:** This displays the slot/port of the interface that this row in the table describes.**GVRP Mode:** Indicates the GVRP administrative mode for the port. It may be enabled or disabled. If this parameter is disabled, Join Time, Leave Time, and Leave All Time have no effect. The factory default is disabled.**GMRP Mode:** Indicates the GMRP administrative mode for the port. It may be enabled or disabled. If this parameter is disabled, Join Time, Leave Time, and Leave All Time have no effect. The factory default is disabled.**6.2.5.5 bridge-ext gvrp**

This command enables GVRP.

**Syntax**

```
bridge-ext gvrp
no bridge-ext gvrp
```

**no** - This command disables GVRP.**Default Setting**

Disabled

**Command Mode**

Global Config

**6.2.5.6 bridge-ext gmrp**

This command enables GARP Multicast Registration Protocol (GMRP) on the system. The default value is disabled.

**Syntax**

```
bridge-ext gmrp  
no bridge-ext gmrp
```

**no** - This command disables GARP Multicast Registration Protocol (GMRP) on the system.

**Default Setting**

Disabled

**Command Mode**

Global Config

**6.2.5.7 switchport gvrp**

This command enables GVRP (GARP VLAN Registration Protocol) for a specific port.

**Syntax**

```
switchport gvrp  
no switchport gvrp
```

**no** - This command disables GVRP (GARP VLAN Registration Protocol) for a specific port. If GVRP is disabled, Join Time, Leave Time, and Leave All Time have no effect.

**Default Setting**

Disabled

**Command Mode**

Interface Config

This command enables GVRP (GARP VLAN Registration Protocol) for all ports.



**Syntax**

```
switchport gvrp all
no switchport gvrp all
```

**all** - All interfaces.

**no** - This command disables GVRP (GARP VLAN Registration Protocol) for all ports. If GVRP is disabled, Join Time, Leave Time, and Leave All Time have no effect.

**Default Setting**

Disabled

**Command Mode**

Global Config

**6.2.5.8 switchport gmrp**

This command enables GMRP Multicast Registration Protocol on a selected interface. If an interface which has GMRP enabled is enabled for routing or is enlisted as a member of a port-channel (LAG), GMRP functionality will be disabled on that interface. GMRP functionality will subsequently be re-enabled if routing is disabled or port-channel (LAG) membership is removed from an interface that has GMRP enabled.

**Syntax**

```
switchport gmrp
no switchport gmrp
```

**no** - This command disables GMRP Multicast Registration Protocol on a selected interface. If an interface which has GMRP enabled is enabled for routing or is enlisted as a member of a port-channel (LAG), GMRP functionality will be disabled on that interface. GMRP functionality will subsequently be re-enabled if routing is disabled or port-channel (LAG) membership is removed from an interface that has GMRP enabled.

**Default Setting**

Disabled

**Command Mode**

Interface Config

This command enables GMRP Multicast Registration Protocol on all interfaces. If an interface which has GMRP enabled is enabled for routing or is enlisted as a member of a port-channel (LAG), GMRP functionality will be disabled on that interface. GMRP functionality will subsequently be re-enabled if routing is disabled and port-channel (LAG) membership is removed from an interface that has GMRP enabled.

**Syntax**

```
switchport gmrp all
no switchport gmrp all
```

**all** - All interfaces.

**no** - This command disables GMRP Multicast Registration Protocol on a selected interface.

**Default Setting**

Disabled

**Command Mode**

Global Config

**6.2.5.9 garp timer**

This command sets the GVRP join time per port and per GARP. Join time is the interval between the transmission of GARP Protocol Data Units (PDUs) registering (or re-registering) membership for a VLAN or multicast group.

This command has an effect only when GVRP and GMRP are enabled. The time is from 10 to 100 (centiseconds).

**Syntax**

```
garp timer join <10-100>
no garp timer join
```

**<10-100>** - join time (Range: 10 – 100) in centiseconds.

**no** - This command sets the GVRP join time per port and per GARP to 20 centiseconds (0.2 seconds). This command has an effect only when GVRP and GMRP are enabled.

**Default Setting**

20 centiseconds (0.2 seconds)

**Command Mode**

Interface Config

This command sets the GVRP join time for all ports and per GARP. Join time is the interval between the transmission of GARP Protocol Data Units (PDUs) registering (or re-registering) membership for a VLAN or multicast group.

This command has an effect only when GVRP and GMRP are enabled. The time is from 10 to 100 (centiseconds).

**Syntax**

```
garp timer join all < 10-100 >  
no garp timer join all
```

**<10-100>** - join time (Range: 10 – 100) in centiseconds.

**all** - All interfaces.

**no** - This command sets the GVRP join time for all ports and per GARP to 20 centiseconds (0.2 seconds). This command has an effect only when GVRP and GMRP are enabled.

**Default Setting**

20 centiseconds (0.2 seconds)

**Command Mode**

Global Config

This command sets the GVRP leave time per port. Leave time is the time to wait after receiving an unregister request for a VLAN or a multicast group before deleting the VLAN entry. This can be considered a buffer time for another station to assert registration for the same attribute in

order to maintain uninterrupted service. The time is from 20 to 600 (centiseconds).

**Note:** This command has an effect only when GVRP and GMRP are enabled.

**Syntax**

```
garp timer leave < 20-600 >  
no garp timer leave
```

**<20-600>** - leave time (Range: 20 – 600) in centiseconds.

**no** - This command sets the GVRP leave time per port to 60 centiseconds (0.6 seconds).

**Note:** This command has an effect only when GVRP and GMRP are enabled.

**Default Setting**

60 centiseconds (0.6 seconds)

**Command Mode**

Interface Config

This command sets the GVRP leave time for all ports. Leave time is the time to wait after receiving an unregister request for a VLAN or a multicast group before deleting the VLAN entry. This can be considered a buffer time for another station to assert registration for the same attribute in order to maintain uninterrupted service. The time is from 20 to 600 (centiseconds).

**Note:** This command has an effect only when GVRP and GMRP are enabled.

**Syntax**

```
garp timer leave all < 20-600 >  
no garp timer leave all
```

**<20-600>** - leave time (Range: 20 – 600) in centiseconds.

**all** - All interfaces.

**no** - This command sets the GVRP leave time for all ports to the default 60 centiseconds (0.6 seconds).

**Note:** This command has an effect only when GVRP and GMRP are enabled.

**Default Setting**

60 centiseconds (0.6 seconds)

**Command Mode**

Global Config

This command sets how frequently Leave All PDUs are generated per port. A Leave All PDU indicates that all registrations will be unregistered. Participants would need to rejoin in order to maintain registration. The value applies per port and per GARP participation. The time may range from 200 to 6000 (centiseconds).

**Note:** This command has an effect only when GVRP and GMRP are enabled.

**Syntax**

```
garp timer leaveall < 200-6000 >  
no garp timer leaveall
```

**<200-6000>** - leave time (Range: 200 – 6000) in centiseconds.

**no** - This command sets how frequently Leave All PDUs are generated per port to 1000 centiseconds (10 seconds).

**Note:** This command has an effect only when GVRP and GMRP are enabled.

**Default Setting**

1000 centiseconds (10 seconds)

**Command Mode**

Interface Config

This command sets how frequently Leave All PDUs are generated for all ports. A Leave All PDU indicates that all registrations will be unregistered. Participants would need to rejoin in order to maintain registration. The value applies per port and per GARP participation. The time

may range from 200 to 6000 (centiseconds).

**Note:** This command has an effect only when GVRP and GMRP are enabled.

**Syntax**

```
garp timer leaveall all < 200-6000 >  
no garp timer leaveall all
```

**<200-6000>** - leave time (Range: 200 – 6000) in centiseconds.

**all** - All interfaces.

**no** - This command sets how frequently Leave All PDUs are generated for all ports to 1000 centiseconds (10 seconds).

**Note:** This command has an effect only when GVRP and GMRP are enabled.

**Default Setting**

1000 centiseconds (10 seconds)

**Command Mode**

Global Config

## 6.2.6 IGMP Snooping

### 6.2.6.1 Show Commands

#### 6.2.6.1.1. show ip igmp snooping

This command displays IGMP Snooping information. Configured information is displayed whether or not IGMP Snooping is enabled. Status information is only displayed when IGMP Snooping is enabled.

**Syntax**

```
show ip igmp snooping
```

**Default Setting**

None

**Command Mode**

Privileged Exec

**Display Message****Admin Mode:** This indicates whether or not IGMP Snooping is active on the switch.**Multicast Control Frame Count:** This displays the number of multicast control frames that are processed by the CPU.**Interfaces Enabled for IGMP Snooping:** This is the list of interfaces on which IGMP Snooping is enabled.**Vlan Enabled for IGMP Snooping:** This is the list of interfaces on which IGMP Snooping is enabled.**6.2.6.1.2. show ip igmp snooping mrouter**

This command displays information on statically configured and dynamically learned multicast router ports or multicast router configuration.

**Syntax**

```
show ip igmp snooping mrouter [ { vlan <vlanid> | interface [slot/port] } ]
```

**<vlanid>** - VLAN ID (Range: 1 – 3965).**slot/port** - The interface number.**Default Setting**

None

**Command Mode**

Privileged Exec

**Display Message****VLAN:** This display VLAN ID value.**Type:** This displays the type of multicast group (Dynamic/Static).**Member Port:** The interface number.**When using 'show ip igmp snooping mrouter interface [slot/port]'****VLAN ID:** This displays VLAN ID value.**Slot/Port:** The interface number.**Multicast Router Attached:** This displays if the interface is enabled as a multicast router port.

### 6.2.6.1.3. show ip igmp snooping

This command displays IGMP Snooping information. Configured information is displayed whether or not IGMP Snooping is enabled.

<b>Syntax</b>
---------------

<b>show ip igmp snooping &lt;1-3965&gt;</b>
---

<1-3965> - VLAN ID (Range: 1 – 3965).

#### Default Setting

None

#### Command Mode

Privileged Exec

#### Display Message

**Vlan ID** This is the list of VLANS on which IGMP Snooping is enabled.

**IGMP Snooping Admin Mode** This indicates whether or not IGMP Snooping is active on the VLAN.

**Fast Leave Mode** This indicates whether or not IGMP Snooping Fast-leave is active on the VLAN.

**Group Membership Interval Time** The Group Membership Interval time is the amount of time in seconds that a switch will wait for a report from a particular group on a particular interface, which is participating in the VLAN, before deleting the interface from the entry. This value may be configured

**Max Response Time** This displays the amount of time the switch will wait after sending a query on an interface, participating in the VLAN, because it did not receive a report for a particular group on that interface. This value may be configured.

**Multicast Router Expiration Time** If a query is not received on an interface, participating in the VLAN, within this amount of time, the interface is removed from the list of interfaces with multicast routers attached. This value may be configured.

### 6.2.6.1.4. show ip igmp snooping static

The user can go to the Privilege Mode to display IGMP snooping static information, use the **show ip igmp snooping static** Privilege command.

<b>Syntax</b>
---------------

<b>show ip igmp snooping static</b>
-------------------------------------



Default Setting

None

**Command Mode**

Privilege Mode

User Mode

**Display Message**

**VLAN:** The VLAN ID used with the MAC address to fully identify packets you want L2Mcast Group.

**MAC Address:** The MAC address of the L2Mcast Group in the format 01:00:5E:xx:xx:xx.

**Port:** List the ports you want included into L2Mcast Group.

**State:** The active interface number belongs to this Multicast Group.

## 6.2.6.2 Configuration Commands

### 6.2.6.2.1. ip igmp snooping

This command enables IGMP Snooping on the system. The default value is disabled.

<b>Syntax</b>
<b>ip igmp snooping</b> <b>no igmp snooping</b>

**no** - This command disables IGMP Snooping on the system.

**Default Setting**

Disabled

**Command Mode**

Global Config

### 6.2.6.2.2. ip igmp snooping groupmembershipinterval

This command sets the IGMP Group Membership Interval time on the system. The Group Membership Interval time is the amount of time in seconds that a switch will wait for a report from a particular group on a particular interface before deleting the interface from the entry.

This value must be greater than the IGMP Maximum Response time value. The range is 1 to 3600 seconds.

**Syntax**

```
ip igmp snooping groupmembershipinterval <2-3600>  
no ip igmp snooping groupmembershipinterval
```

**<2-3600>** - interval time (Range: 2 – 3600) in seconds.

**no** - This command sets the IGMP Group Membership Interval time on the system to 260 seconds.

**Default Setting**

260 seconds

**Command Mode**

Global Config, Interface Config

**6.2.6.2.3. ip igmp snooping interfacemode**

This command enables IGMP Snooping on a selected interface. If an interface which has IGMP Snooping enabled is enabled for routing or is enlisted as a member of a port-channel (LAG), IGMP Snooping functionality will be disabled on that interface. IGMP Snooping functionality will subsequently be re-enabled if routing is disabled or port-channel (LAG) membership is removed from an interface that has IGMP Snooping enabled.

**Syntax**

```
ip igmp snooping interfacemode  
no ip igmp snooping interfacemode
```

**no** - This command disables IGMP Snooping on a selected interface.

**Default Setting**

Disabled

**Command Mode**

Interface Config

This command enables IGMP Snooping on all interfaces. If an interface which has IGMP Snooping enabled is enabled for routing or is enlisted as a member of a port-channel (LAG), IGMP Snooping functionality will be disabled on that interface. IGMP Snooping functionality will subsequently be re-enabled if routing is disabled or port-channel (LAG) membership is removed from an interface that has IGMP Snooping enabled.

**Syntax**

```
ip igmp snooping interfacemode all
```

**all** - All interfaces.

**no** - This command disables IGMP Snooping on all interfaces.

**Default Setting**

Disabled

**Command Mode**

Global Config

**6.2.6.2.4. ip igmp snooping mcrtexpiretime**

This command sets the Multicast Router Present Expiration time on the system. This is the amount of time in seconds that a switch will wait for a query to be received on an interface before the interface is removed from the list of interfaces with multicast routers attached. The range is 0 to 3600 seconds. A value of 0 indicates an infinite timeout, that is, no expiration.

**Syntax**

```
ip igmp snooping mcrtexpiretime <0-3600>  
no ip igmp snooping mcrtexpiretime
```

**<0-3600>** - Expiration time (Range: 0 – 3600).

**no** - This command sets the Multicast Router Present Expiration time on the system to 0. A value of 0 indicates an infinite timeout, that is no expiration.

**Default Setting**

0

**Command Mode**

Global Config, Interface Config

**6.2.6.2.5. ip igmp snooping max-response-time**

This command sets the IGMP Maximum Response time on the system. The Maximum Response time is the amount of time in seconds that a switch will wait after sending a query on an interface because it did not receive a report for a particular group in that interface. This value must be less than the IGMP Query Interval time value. The range is 1 to 3600 seconds.

**Syntax**

```
ip igmp snooping max-response-time <sec>  
no ip igmp snooping max-response-time
```

**<sec>** - Max time (Range: 1 – 3599).

**no** - This command sets the IGMP Maximum Response time on the system to 10 seconds.

**Default Setting**

10 seconds

**Command Mode**

Global Config, Interface Config.

**6.2.6.2.6. ip igmp snooping fast-leave**

This command enables or disables IGMP Snooping fast-leave admin mode on a selected interface or on all interfaces. Enabling fastleave allows the switch to immediately remove the layer 2 LAN interface from its forwarding table entry upon receiving an IGMP leave message for that multicast group without first sending out MAC-based general queries to the interface(s). Fast-leave admin mode should be enabled only on VLANs where only one host is connected to each layer 2 LAN port, to prevent the inadvertent dropping of the other hosts that were connected to the same layer 2 LAN port but were still interested in receiving multicast traffic directed to that group. Also, fast-leave processing is supported only with IGMP version 2 hosts.

**Syntax**

```
ip igmp snooping fast-leave  
no ip igmp snooping fast-leave
```

**no** - This command disables IGMP Snooping fast-leave admin mode.

**Default Setting**

Disabled

**Command Mode**

Global Config, Interface Config.

**6.2.6.2.7. ip igmp snooping mrouter**

This command configures a selected interface as a multicast router interface. When configured as a multicast router interface, the interface is treated as a multicast router interface in all VLANs.

**Syntax**

```
ip igmp snooping mrouter interface  
no ip igmp snooping mrouter interface
```

**no** - This command disables the status of the interface as a statically configured multicast router interface.

**Default Setting**

Disabled

**Command Mode**

Interface Config.

**6.2.6.2.8. ip igmp snooping mrouter**

This command configures the VLAN ID(<vlanId>) that has the multicast router mode enabled.

**Syntax**

- ip igmp snooping mrouter <vlanId>
- no set igmp snooping mrouter <vlanId>

**<vlanid>** - VLAN ID.

**no** - This command disables the status of the interface as a statically configured multicast router interface.

#### Default Setting

Disabled

#### Command Mode

Interface Config.

#### 6.2.6.2.9. ip igmp snooping vlan static

This command is used to add a port to a multicast group.

<b>Syntax</b>
---------------

<b>ip igmp snooping vlan &lt;vlanid&gt; static &lt;macaddr&gt; interface &lt;slot/port&gt;</b>
--

**<vlanid>** - VLAN ID (Range: 1 – 3965).

**<macaddr>** - Multicast group MAC address.

**<slot/port>** - Interface number.

#### Default Setting

None

#### Command Mode

Global Config

#### Command Usage

The maximum number of static router ports that can be configured is 64.

#### 6.2.6.2.10. ip igmp snooping static

The user can go to the Global Mode and add a port to multicast group, use the **ip igmp snooping static** Global command.

**Syntax**

```
ip igmp snooping static <macaddr> vlan <vlan-id> interface <slot/port>  
no ip igmp snooping static <macaddr> vlan <vlan-id> interface <slot/port>
```

Default Setting

None

**Command Mode**

Global Mode

**6.2.6.2.11. set igmp**

This command enables IGMP snooping on a particular VLAN, and in turn enabling IGMP snooping on all interfaces participating in this VLAN.

**Syntax**

```
set igmp <1-3965>  
no set igmp <1-3965>
```

<1-3965> - VLAN ID (Range: 1 – 3965).

**no** - This command disables IGMP snooping on a particular VLAN, and in turn disabling IGMP snooping on all interfaces participating in this VLAN.

**Default Setting**

None

**Command Mode**

Vlan Database

**6.2.6.2.12. set igmp groupmembership-interval**

This command sets the IGMP Group Membership Interval on a particular VLAN. The Group Membership Interval time is the amount of time in seconds that a switch will wait for a report from a particular group on a particular interface, which is participating in the VLAN, before deleting the interface from the entry. This value must be greater than IGMP Maximum Response time value. The range is 2 to 3600 seconds.

**Syntax**

```
set igmp groupmembership-interval <1-3965> <2-3600>  
no set igmp groupmembershipinterval <1-3965>
```

<1-3965> - VLAN ID (Range: 1 – 3965).

<2-3600> - The range of group membership interval time is 2 to 3600 seconds.

**no** - This command sets the IGMP Group Membership Interval time on a particular VLAN to the default value.

**Default Setting**

260

**Command Mode**

Vlan Database

**6.2.6.2.13. set igmp maxresponse**

This command sets the IGMP Maximum Response time on a particular VLAN. The Maximum Response time is the amount of time in seconds that a switch will wait after sending a query on an interface, which is participating in the VLAN, because it did not receive a report for a particular group in that interface. This value must be less than the IGMP Query Interval time value.

**Syntax**

```
set igmp maxresponse <1-3965> <1-3599>  
no set igmp maxresponse <1-3965>
```

<1-3965> - VLAN ID (Range: 1 – 3965).

**no** - This command sets the IGMP maximum response time on a particular VLAN to the default value.

**Default Setting**



10

**Command Mode**

Vlan Database

**6.2.6.2.14. set igmp mcrtexpiretime**

This command sets the Multicast Router Present Expiration time on a particular VLAN. This is the amount of time in seconds that a switch will wait for a query to be received on an interface, which is participating in the VLAN, before the interface is removed from the list of interfaces with multicast routers attached. The range is 0 to 3600 seconds. A value of 0 indicates an infinite time-out, i.e. no expiration.

**Syntax**

```
set igmp mcrtexpiretime <1-3965> <0-3600>  
no set igmp mcrtexpiretime <1-3965>
```

<1-3965> - VLAN ID (Range: 1 – 3965).

<0-3600> - The range of the Multicat Router Present Expire time is 0 to 3600 seconds.

**no** - This command sets the IGMP Multicast Router Present Expire time on a particular VLAN to the default value.

**Default Setting**

10

**Command Mode**

Vlan Database

**6.2.6.2.15. set igmp fast-leave**

This command enables or disables IGMP Snooping fast-leave admin mode on a selected VLAN. Enabling fastleave allows the switch to immediately remove the layer 2 LAN interface, participating in the VLAN, from its forwarding table entry upon receiving an IGMP leave message for that multicast group without first sending out MAC-based general queries to the interface. Fast-leave admin mode should be enabled only on VLANs where only one host is connected to each layer 2 LAN port, to prevent the inadvertent dropping of the other hosts that

were connected to the same layer 2 LAN port but were still interested in receiving multicast traffic directed to that group. Also, fast-leave processing is supported only with IGMP version 2 hosts.

**Syntax**

```
set igmp fast-leave <1-3965>  
no set igmp fast-leave <1-3965>
```

<1-3965> - VLAN ID (Range: 1 – 3965).

**no** - This command disables IGMP Snooping fast-leave admin mode on a selected VLAN.

**Default Setting**

None

**Command Mode**

Vlan Database

## 6.2.7 IGMP Snooping Querier

### 6.2.7.1 Show Commands

#### 6.2.7.1.1. Display IGMP snooping querier global info

This command display IGMP snooping querier global information on the system.

**Syntax**

```
show ip igmp snooping querier
```

**Default Setting**

None

**Command Mode**

Privileged Exec  
User Exec

**Display Message**

**IGMP Snooping Querier Mode:** Administrative mode for IGMP Snooping. The default is disable.

**Querier Address:** Specify the Snooping Querier Address to be used as source address in periodic IGMP queries. This address is used when no address is configured on the VLAN on which query is being sent

**IGMP Version:** Specify the IGMP protocol version used in periodic IGMP queries.

**Querier Interval:** Specify the time interval in seconds between periodic queries sent by the snooping querier. The Query Interval must be a value in the range of 1 and 1800. The default value is 60

**Querier Expiry Interval:** Specify the time interval in seconds after which the last querier information is removed. The Querier Expiry Interval must be a value in the range of 60 and 300. The default value is 60.

#### 6.2.7.1.2. Display IGMP snooping querier vlan info

This command display IGMP snooping querier global information on the system.

<b>Syntax</b>
---------------

<b>show ip igmp snooping querier vlan &lt;1-3965&gt;</b>
--

#### Default Setting

None

#### Command Mode

Privileged Exec  
User Exec

#### Display Message

**IGMP Snooping Vlan Mode:** Display the administrative mode for IGMP Snooping for the switch.

**Querier Election Participation Mode:** Displays the querier election participate mode on the VLAN. When this mode is disabled, up on seeing a query of the same version in the vlan, the snooping querier move to non querier state. Only when this mode is enabled, the snooping querier will participate in querier election where in the least ip address will win the querier election and operates as the querier in that VLAN. The other querier moves to non-querier state

**Querier Vlan Address:** Displays the Snooping Querier Address to be used as source address in periodic IGMP queries sent on the specified VLAN.

**Operational State:** Specifies the operational state of the IGMP Snooping Querier on a VLAN.

**Operational Version:** Displays the operational IGMP protocol version of the querier.

#### 6.2.7.1.3. Display IGMP snooping querier detail information

This command display all of IGMP snooping querier information on the system.

**Syntax**

```
show ip igmp snooping querier detail
```

**Default Setting**

None

**Command Mode**Privileged Exec  
User Exec**Display Message**

**IGMP Snooping Querier Mode:** Administrative mode for IGMP Snooping. The default is disable

**Querier Address:** Specify the Snooping Querier Address to be used as source address in periodic IGMP queries. This address is used when no address is configured on the VLAN on which query is being sent

**IGMP Version:** Specify the IGMP protocol version used in periodic IGMP queries.

**Querier Interval:** Specify the time interval in seconds between periodic queries sent by the snooping querier. The Query Interval must be a value in the range of 1 and 1800. The default value is 60.

**Querier Expiry Interval:** Specify the time interval in seconds after which the last querier information is removed. The Querier Expiry Interval must be a value in the range of 60 and 300. The default value is 60

**Last Querier Address:** Displays the IP address of the last querier from which a query was snooped on the VLAN

**6.2.7.2 Configuration Commands****6.2.7.2.1. Set IGMP snooping querier admin mode**

The user can go to the CLI Global Configuration Mode to set IGMP snooping querier admin mode, use the **ip igmp snooping querier** global configuration command. Use the **no ip igmp snooping querier** to disable.

**Syntax**

```
ip igmp snooping querier  
no ip igmp snooping querier
```

**Default Setting**

Disable

**Command Mode**

Global Configure

#### 6.2.7.2.2. Set IGMP snooping querier address

The user can go to the CLI Global Configuration Mode to set IGMP snooping querier address, use the **ip igmp snooping querier address <ip-address>** global configuration command. Use the **no ip igmp snooping querier address** return to default value zero.

##### Syntax

```
ip igmp snooping querier address <ip-address>  
no ip igmp snooping querier address
```

#### Default Setting

0

#### Command Mode

Global Configure

#### 6.2.7.2.3. Set IGMP snooping querier query interval

The user can go to the CLI Global Configuration Mode to set IGMP snooping querier query interval, use the **ip igmp snooping querier query-interval <1-1800>** global configuration command. Use the **no ip igmp snooping querier query-interval** return to default value zero.

##### Syntax

```
ip igmp snooping querier query-interval <1-1800>  
no ip igmp snooping querier query-interval
```

#### Default Setting

0

#### Command Mode

Global Configure

#### 6.2.7.2.4. Set IGMP snooping querier querier interval

The user can go to the CLI Global Configuration Mode to set IGMP snooping querier querier expiry interval, use the **ip igmp snooping querier querier-expiry-interval <60-300>** global configuration command. Use the **no ip igmp snooping querier query-interval** return to default value zero.

**Syntax**

```
ip igmp snooping querier querier-expiry-interval <60-300>  
no ip igmp snooping querier querier-expiry-interval
```

**Default Setting**

0

**Command Mode**

Global Configure

**6.2.7.2.5. Set IGMP snooping query version**

The user can go to the CLI Global Configuration Mode to set IGMP snooping querier version, use the **ip igmp snooping querier version <1-2>** global configuration command. Use the **no ip igmp snooping querier version** return to default value zero.

**Syntax**

```
ip igmp snooping querier version <1-2>  
no ip igmp snooping querier version
```

**Default Setting**

0

**Command Mode**

Global Configure

**6.2.7.2.6. Set IGMP snooping querier vlan admin mode**

The user can go to the CLI Global Configuration Mode to set IGMP snooping querier vlan admin mode, use the **ip igmp snooping querier vlan <1-3965>** global configuration command. Use the **no ip igmp snooping querier vlan <1-3965>** return to disable.

**Syntax**

```
ip igmp snooping querier vlan <1-3965>  
no ip igmp snooping querier vlan <1-3965>
```

**Default Setting**

0

**Command Mode**

Global Configure

**6.2.7.2.7. Set IGMP snooping querier vlan address**

The user can go to the CLI Global Configuration Mode to set IGMP snooping querier vlan address, use the **ip igmp snooping querier vlan <1-3965> address <ip-address>** global configuration command. Use the **no ip igmp snooping querier vlan <1-3965> address** return to default value zero.

**Syntax**

```
ip igmp snooping querier vlan <1-3965> address <ip-address>  
no ip igmp snooping querier vlan <1-3965> address
```

**Default Setting**

0

**Command Mode**

Global Configure

**6.2.7.2.8. Set IGMP snooping querier vlan election mode**

The user can go to the CLI Global Configuration Mode to set IGMP snooping querier vlan election participate mode, use the **ip igmp snooping querier vlan <1-3965> election-participate** global configuration command. Use the **no ip igmp snooping querier vlan <1-3965> election participate** return to disable.

**Syntax**

```
ip igmp snooping querier vlan <1-3965> election participate  
no ip igmp snooping querier vlan <1-3965> election participate
```

**Default Setting**

0

**Command Mode**

Global Configure

**6.2.8 MLD Snooping**

### 6.2.8.1 Show Commands

#### 6.2.8.1.1. show ipv6 mld snooping

The user can go to the CLI Privilege Mode to get all of mld snooping information, use the **show ip mld snooping** Privilege command.

<b>Syntax</b>
---------------

<b>show ipv6 mld snooping</b> [<slot/port> <vlan-id>]
---

#### Default Setting

None

#### Command Mode

Privileged Exec  
User Exec

#### Display Message

When the optional arguments <slot/port> or <vlanid> are not used, the command displays the following information.

<b>Admin Mode</b>	Indicates whether or not MLD Snooping is active on the switch
<b>Interfaces Enabled for MLD Snooping</b>	Interfaces on which MLD Snooping is enabled.
<b>MLD Control Frame Count</b>	Displays the number of MLD Control frames that are processed by the CPU
<b>VLANs Enabled for MLD Snooping</b>	VLANs on which MLD Snooping is enabled

When you specify the <slot/port> values, the following information displays.

<b>MLD Snooping Admin Mode</b>	Indicates whether MLD Snooping is active on the interface.
<b>Fast Leave Mode</b>	Indicates whether MLD Snooping Fast Leave is active on the interface.
<b>Group Membership Interval</b>	Shows the amount of time in seconds that a switch will wait for a report from a particular group on a particular interface, which is participating on the interface, before deleting the interface from the entry. This value may be configured.
<b>Max Response Time</b>	Interface on which MLD Snooping is enabled
<b>Multicast Router Present Expiration Time</b>	Displays the amount of time to wait before removing an interface that is participating on the interface from the list of interfaces with multicast routers attached. The interface is removed if a query is



not received. This value may be configured.

When you specify a value for <vlanid>, the following information appears.

<b>VLAN ID</b>	Vlan id
<b>MLD Snooping Admin Mode</b>	Indicates whether MLD Snooping is active on the VLAN.
<b>Fast Leave Mode</b>	Indicates whether MLD Snooping Fast Leave is active on the VLAN.
<b>Group Membership Interval</b>	Shows the amount of time in seconds that a switch will wait for a report from a particular group on a particular interface, which is participating in the VLAN, before deleting the interface from the entry. This value may be configured.
<b>Max Response Time</b>	VLANs on which MLD Snooping is enabled
<b>Multicast Router Present Expiration Time</b>	Displays the amount of time to wait before removing an interface that is participating in the VLAN from the list of interfaces with multicast routers attached. The interface is removed if a query is not received. This value may be configured.

#### 6.2.8.1.2. show ipv6 mld snooping mrouter interface

The user can go to the CLI Privilege Mode to display information about statically configured multicast router-attached, use the **show ipv6 mld snooping mrouter** Privilege command.

#### Syntax

```
show ipv6 mld snooping mrouter
```

#### Default Setting

None

#### Command Mode

Privileged Exec  
User Exec

#### Display Message

<b>Interface</b>	Shows the interface on which multicast router information is being displayed.
<b>Multicast Router Attached</b>	Indicates whether multicast router is statically enabled on the interface.

**VLAN ID** Displays the list of VLANs of which the interface is a member.

#### 6.2.8.1.3. show ipv6 mld snooping mrouter interface

The user can go to the CLI Privilege Mode to display information about statically configured multicast router-attached interfaces, use the **show ipv6 mld snooping mrouter interface** Privilege command.

##### Syntax

```
show ipv6 mld snooping mrouter interface <slot/port>
```

##### Default Setting

None

##### Command Mode

Privileged Exec  
User Exec

##### Display Message

<b>Interface</b>	Shows the interface on which multicast router information is being displayed.
<b>Multicast Router Attached</b>	Indicates whether multicast router is statically enabled on the interface.
<b>VLAN ID</b>	Displays the list of VLANs of which the interface is a member.

#### 6.2.8.1.4. show ipv6 mld snooping mrouter vlan

The user can go to the CLI Privilege Mode to display information about statically configured multicast router-attached interfaces, use the **show ipv6 mld snooping mrouter vlan** Privilege command.

##### Syntax

```
show ipv6 mld snooping mrouter vlan <slot/port>
```

##### Default Setting

None

##### Command Mode

Privileged Exec

User Exec

### Display Message

<b>VLAN ID</b>	Displays the list of VLANs of which the interface is a member.
<b>Interface</b>	Shows the interface on which multicast router information is being displayed.

#### 6.2.8.1.5. show ipv6 mld snooping static

The user can go to the Privilege Mode to display MLD snooping static information, use the **show ipv6 mld snooping static** Privilege command.

<b>Syntax</b>
---------------

<b>show ipv6 mld snooping static</b>
--------------------------------------

#### Default Setting

None

#### Command Mode

Privilege Exec

User Exec

#### Display Message

**VLAN:** The VLAN ID used with the MAC address to fully identify packets you want L2Mcast Group.

**MAC Address:** The MAC address of the L2Mcast Group in the format 33:33:xx:xx:xx:xx.

**Port:** List the ports you want included into L2Mcast Group.

**State:** The active interface number belongs to this Multicast Group.

#### 6.2.8.1.6. show mac-address-table mld Snooping

The user can go to the CLI Privilege Mode to display the MLD Snooping entries in the Multicast Forwarding Database (MFDB) table, use the **show mac-address-table mld Snooping** Privilege command.

<b>Syntax</b>
---------------

<b>show mac-address-table mld Snooping</b>
--

**Default Setting**

None

**Command Mode**

Privileged Exec

**Display Message**

<b>MAC Address</b>	A multicast MAC address for which the switch has forwarding or filtering information. The format is twodigit hexadecimal numbers that are separated by colons, for example 33:33:45:67:89:AB.
<b>Type</b>	The type of entry, which is either static (added by the user) or dynamic (added to the table as a result of a learning process or protocol.)
<b>Description</b>	The text description of this multicast table entry.
<b>Interfaces</b>	The list of interfaces that are designated for forwarding (Fwd:) and filtering (Flt:).

**6.2.8.2 Configuration Commands**
**6.2.8.2.1. ipv6 mld snooping**

The user can go to the CLI Global/Interface Configuration Mode to set MLD Snooping on the system or an Interface, use the **ipv6 mld snooping** global/interface configuration command. Use the **no ipv6 mld snooping** to disable MLD Snooping on the system or an Interface.

<b>Syntax</b>
---------------

<b>ip mld snooping</b> <b>no ip mld snooping</b>
---

**Default Setting**

Disable

**Command Mode**

Global Configure  
Interface Configure

**6.2.8.2.2. ipv6 mld snooping interfacemode**

The user can go to the CLI Global/Interface Configuration Mode to set MLD Snooping on one interface or all interfaces, use the **ipv6 mld snooping interfacemode** global/interface

configuration command. Use the **no ipv6 mld snooping interfacemode** disable MLD Snooping on all interfaces.

**Syntax**

```
ipv6 mld snooping interfacemode <all>  
no ipv6 mld snooping interfacemode <all>
```

**Default Setting**

Disable

**Command Mode**

Global Configure  
Interface Configure

**6.2.8.2.3. ipv6 mld snooping fast-leave**

The user can go to the CLI Global/Interface Configuration Mode to set MLD Snooping fast-leave admin mode on a selected interface or all interfaces, use the **ipv6 mld snooping fast-leave** global/interface configuration command. Use the **no ipv6 mld snooping fast-leave** disable MLD Snooping fast-leave admin mode.

**Syntax**

```
ipv6 mld snooping fast-leave  
no ipv6 mld snooping fast-leave
```

**Default Setting**

Disable

**Command Mode**

Global Configure  
Interface Configure

**6.2.8.2.4. ipv6 mld snooping groupmembershipinterval**

The user can go to the CLI Global/Interface Configuration Mode to set the MLD Group Membership Interval time on one interface or all interfaces, use the **ipv6 mld snooping groupmembershipinterval <2-3600>** global/interface configuration command. Use the **no ipv6 mld snooping groupmembershipinterval** return to default value 260.

**Syntax**

```
ipv6 mld snooping groupmembershipinterval <2-3600>  
no ipv6 mld snooping groupmembershipinterval
```

**Default Setting**

260

**Command Mode**Global Configure  
Interface Configure**6.2.8.2.5. ipv6 mld snooping max-response-time**

The user can go to the CLI Interface Global/Interface Configuration Mode to set the MLD Maximum Response time for the system, on a particular interface, use the **ipv6 mld snooping max-response-time <1-3599>** global/interface configuration command. Use the **no ipv6 mld snooping max-response-time** return to default value 10

**Syntax**

```
ipv6 mld snooping max-response-time <1-3599>  
no ipv6 mld snooping max-response-time
```

**Default Setting**

10

**Command Mode**Global Configure  
Interface Configure**6.2.8.2.6. ipv6 mld snooping mctrexpiretime**

The user can go to the CLI Interface Global/Interface Configuration Mode to set the Multicast Router Present Expiration time for the system or on a particular interface, use the **ipv6 mld snooping mctrexpiretime <0-3600>** global/interface configuration command. Use the **no ipv6 mld snooping mctrexpiretime** to return to default value 0.

**Syntax**

```
ipv6 mld snooping mctrexpiretime <0-3600>  
no ipv6 mld snooping mctrexpiretime
```

**Default Setting**

0

**Command Mode**Global Configure  
Interface Configure**6.2.8.2.7. ipv6 mld snooping mrouter interface**

The user can go to the CLI Interface Configuration Mode to configure the interface as a multicast router-attached interface or configure the VLAN ID for the VLAN that has the multicast router attached mode enabled, use the **ipv6 mld snooping mrouter interface interface|<vlanId>** interface configuration command. Use the **no ipv6 mld snooping mrouter interface|<vlanId>** disable multicast router attached mode for the interface or a VLAN.

**Syntax**

```
ipv6 mld snooping mrouter interface interface|<vlanId>  
no ipv6 mld snooping mrouter interface|<vlanId>
```

**Default Setting**

None

**Command Mode**

Interface Configure

**6.2.8.2.8. ipv6 mld snooping static**

The user can go to the Global Mode and add a port to ipv6 multicast group, use the **ipv6 mld snooping static** Global command.

**Syntax**

```
ipv6 mld snooping static <macaddr> vlan <vlan-id> interface <slot/port>  
no ipv6 mld snooping static <macaddr> vlan <vlan-id> interface <slot/port>
```

**Default Setting**

None

**Command Mode**

Global Mode

#### 6.2.8.2.9. set mld

The user can go to the CLI VLAN Mode to set MLD Snooping on a particular VLAN, use the **set mld <vlanid>** vlan configuration command. Use the **no set mld <vlanid>** to disable MLD Snooping on a particular VLAN.

##### Syntax

```
set mld <vlanid>  
no set mld <vlanid>
```

##### Default Setting

Disable

##### Command Mode

VLAN Mode

#### 6.2.8.2.10. set mld fast-leave

The user can go to the CLI VLAN Configuration Mode to set MLD Snooping fast-leave admin mode on a particular VLAN, use the **set mld fast-leave <vlanid>** vlan configuration command. Use the **no set mld fast-leave <vlanid>** disable MLD Snooping fast-leave admin mode.

##### Syntax

```
set mld fast-leave <vlanid>  
no set mld fast-leave <vlanid>
```

##### Default Setting

Disable

##### Command Mode

VLAN Mode

#### 6.2.8.2.11. set mld groupmembership-interval

The user can go to the CLI VLAN Configuration Mode to set the MLD Group Membership Interval time on a particular VLAN, use the **set mld groupmembership-interval <vlanid> <2-3600>** vlan configuration command. Use the **no set mld groupmembership-interval <vlanid>** return to default value 260.

##### Syntax

```
set mld groupmembership-interval <vlanid> <2-3600>  
no set mld groupmembership-interval <vlanid>
```



**Default Setting**

260

**Command Mode**

VLAN Mode

**6.2.8.2.12. set mld maxresponse**

The user can go to the CLI Interface VLAN Mode to set the MLD Maximum Response time on a particular VLAN, use the **set mld max-response-time <vlanid> <1-3599>** vlan configuration command. Use the **no set mld max-response-time <vlanid>** return to default value 10.

**Syntax**

```
set mld max-response-time <vlanid> <1-3599>
no set mld max-response-time <vlanid>
```

**Default Setting**

10

**Command Mode**

VLAN Mode

**6.2.8.2.13. set ipv6 mld mcrtrexpiretime**

The user can go to the CLI Interface VLAN Configuration Mode to set the Multicast Router Present Expiration time on a particular VLAN, use the **set mld mcrtrexpiretime <vlanid> <0-3600>** vlan configuration command. Use the **no set mld mcrtrexpiretime <vlanid>** to return to default value 0.

**Syntax**

```
set mld mcrtrexpiretime <vlanid> <0-3600>
no set mld mcrtrexpiretime <vlanid>
```

**Default Setting**

0

**Command Mode**

VLAN Mode

## 6.2.9 MLD Snooping Querier

### 6.2.9.1 Show Commands

#### 6.2.9.1.1. Display MLD snooping querier global information

This command display MLD snooping querier global information on the system.

<b>Syntax</b>
---------------

<b>show ipv6 mld snooping querier</b>
---------------------------------------

#### Default Setting

None

#### Command Mode

Privileged Exec  
User Exec

#### Display Message

**MLD Snooping Querier Mode:** Specify the Snooping Querier Address to be used as source address in periodic MLD queries. This address is used when no address is configured on the VLAN on which query is being sent.

**Querier Address:** Specify the Snooping Querier Address to be used as source address in periodic MLD queries. This address is used when no address is configured on the VLAN on which query is being sent.

**MLD Version:** Specify the MLD protocol version used in periodic MLD queries.

**Querier Interval:** Specify the time interval in seconds between periodic queries sent by the snooping querier. The Query Interval must be a value in the range of 1 and 1800. The default value is 60.

**Querier Expiry Interval:** Specify the time interval in seconds after which the last querier information is removed. The Querier Expiry Interval must be a value in the range of 60 and 300. The default value is 60

#### 6.2.9.1.2. Display MLD snooping querier vlan information

This command display MLD snooping querier vlan information on the system.

<b>Syntax</b>
---------------

<b>show ipv6 mld snooping querier vlan &lt;1-3965&gt;</b>
---

#### Default Setting

None

**Command Mode**

Privileged Exec  
User Exec

**Display Message**

**MLD Snooping Querier Vlan Mode:** Displays the querier election participate mode on the VLAN. When this mode is disabled, up on seeing a query of the same version in the vlan, the snooping querier move to non querier state. Only when this mode is enabled, the snooping querier will participate in querier election where in the least ip address will win the querier election and operates as the querier in that VLAN. The other querier moves to non-querier state.

**Querier Vlan Address:** Displays the Snooping Querier Address to be used as source address in periodic MLD queries sent on the specified VLAN.

**Operational State:** Specifies the operational state of the MLD Snooping Querier on a VLAN.

**Operational Version:** Displays the operational MLD protocol version of the querier.

**6.2.9.1.3. Display MLD snooping querier all of information**

This command display all of MLD snooping querier information on the system.

**Syntax**

```
show ipv6 mld snooping querier detail
```

**Default Setting**

None

**Command Mode**

Privileged Exec  
User Exec

**Display Message**

**MLD Snooping Querier Mode:** Administrative mode for MLD Snooping. The default is disable

**Querier Address:** Specify the Snooping Querier Address to be used as source address in periodic MLD queries. This address is used when no address is configured on the VLAN on which query is being sent.

**MLD Version:** Specify the MLD protocol version used in periodic IGMP queries.

**Querier Interval:** Specify the time interval in seconds between periodic queries sent by the snooping querier. The Query Interval must be a value in the range of 1 and 1800. The default value is 60.

**Querier Expiry Interval:** Specify the time interval in seconds after which the last querier information is removed. The Querier Expiry Interval must be a value in the range of 60 and 300. The default value is 60.

**Last Querier Address:** Displays the IP address of the last querier from which a query was snooped on the VLAN.

## 6.2.9.2 Configuration Commands

### 6.2.9.2.1. Set MLD snooping querier admin mode

The user can go to the CLI Global Configuration Mode to set MLD snooping querier admin mode, use the **ipv6 mld snooping querier** global configuration command. Use the **no ipv6 mld snooping querier** to disable.

#### Syntax

```
ipv6 mld snooping querier
no ipv6 mld snooping querier
```

#### Default Setting

Disable

#### Command Mode

Global Configure

### 6.2.9.2.2. Set MLD snooping querier address

The user can go to the CLI Global Configuration Mode to set MLD snooping querier address, use the **ipv6 mld snooping querier address <ipv6-address>** global configuration command. Use the **ipv6 mld snooping querier address <ipv6-address>** return to default value zero.

#### Syntax

```
ipv6 mld snooping querier address <ipv6-address>
no ipv6 mld snooping querier address <ipv6-address>
```

#### Default Setting

0

#### Command Mode

Global Configure

### 6.2.9.2.3. Set MLD snooping querier querier interval

The user can go to the CLI Global Configuration Mode to set MLD snooping querier querier interval, use the **ipv6 mld snooping querier querier-interval <1-1800>** global configuration command. Use the **no ipv6 mld snooping querier query-interval** return to default value zero.

**Syntax**

```
ipv6 mld snooping querier querier-interval <1-1800>  
no ipv6 mld snooping querier querier-interval
```

**Default Setting**

0

**Command Mode**

Global Configure

**6.2.9.2.4. Set MLD snooping querier querier expiry interval**

The user can go to the CLI Global Configuration Mode to set MLD snooping querier querier expiry interval, use the **ipv6 mld snooping querier querier-expiry-interval <60-300>** global configuration command. Use the **no ipv6 mld snooping querier querier-expiry-interval** return to default value zero.

**Syntax**

```
ipv6 mld snooping querier querier-expiry-interval <60-300>  
no ipv6 mld snooping querier querier-expiry-interval
```

**Default Setting**

0

**Command Mode**

Global Configure

**6.2.9.2.5. Set MLD snooping querier vlan admin mode**

The user can go to the CLI Global Configuration Mode to set MLD snooping querier vlan admin mode, use the **ipv6 mld snooping querier vlan <1-3965>** global configuration command. Use the **no ipv6 mld snooping querier vlan <1-3965>** return to disable.

**Syntax**

```
ipv6 mld snooping querier vlan <1-3965>  
no ipv6 mld snooping querier vlan <1-3965>
```

**Default Setting**

Disable

**Command Mode**

Global Configure

**6.2.9.2.6. Set MLD snooping querier vlan address**

The user can go to the CLI Global Configuration Mode to set MLD snooping querier vlan address, use the **ipv6 mld snooping querier vlan <1-3965> address <ip-address>** global configuration command. Use the **no ipv6 mld snooping querier vlan <1-3965> address <ip-address>** return to default value zero.

**Syntax**

```
ipv6 mld snooping querier vlan <1-3965> address <ip-address>  
no ipv6 mld snooping querier vlan <1-3965> address <ip-address>
```

**Default Setting**

Disable

**Command Mode**

Global Configure

**6.2.9.2.7. Set MLD snooping querier vlan election mode**

The user can go to the CLI Global Configuration Mode to set MLD snooping querier vlan election participate mode, use the **ipv6 mld snooping querier vlan <1-3965> election-participate** global configuration command. Use the **no ipv6 mld snooping querier vlan <1-3965> election participate** return to disable.

**Syntax**

```
ipv6 mld snooping querier vlan <1-3965> election participate  
no ipv6 mld snooping querier vlan <1-3965> election participate
```

**Default Setting**

Disable

**Command Mode**

Global Configure

**6.2.10 Port Channel**

### 6.2.10.1 show port-channel

This command displays the static capability of all port-channels (LAGs) on the device as well as a summary of individual port-channels.

**Syntax**

```
show port-channel
```

**Default Setting**

None

**Command Mode**

Privileged Exec

**Display Message****For each port-channel the following information is displayed:**

**Logical Interface:** The field displays logical slot and the logical port.

**Port-Channel Name:** This field displays the name of the port-channel.

**Link State:** This field indicates whether the link is up or down.

**Mbr Ports:** This field lists the ports that are members of this port-channel, in slot/port notation.

**Active Ports:** This field lists the ports that are actively participating in this port-channel.

This command displays an overview of all port-channels (LAGs) on the switch.

**Syntax**

```
show port-channel {<logical slot/port> | all}
```

**<logical slot/port>** - Port-Channel Interface number.

**all** – all Port-Channel interfaces.

**Default Setting**

None

**Command Mode**

Privileged Exec

**Display Message**

**Log. Intf:** The logical slot and the logical port.

**Port-Channel Name:** The name of this port-channel (LAG). You may enter any string of up to 15 alphanumeric characters.

**Link :** Indicates whether the Link is up or down.

**Admin Mode:** May be enabled or disabled. The factory default is enabled.

**Link Trap Mode:** This object determines whether or not to send a trap when link status changes. The factory default is enabled.

**STP Mode:** The Spanning Tree Protocol Administrative Mode associated with the port or port channel (LAG). The possible values are:

**Disable:** Spanning tree is disabled for this port.

**Enable:** Spanning tree is enabled for this port. (Default Value)

**Mbr Ports:** A listing of the ports that are members of this port-channel (LAG), in slot/port notation. There can be a maximum of eight ports assigned to a given port-channel (LAG).

**Port Speed:** Speed of the port-channel port.

**Type:** This field displays the status designating whether a particular port-channel (LAG) is statically or dynamically maintained. The possible values of this field are Static, indicating that the port-channel is statically maintained; and Dynamic, indicating that the port-channel is dynamically maintained.

**LB:** This field displays the load-balance status whether a particular port-channel (LAG) is maintained.

**Port Active:** This field lists the ports that are actively participating in the port-channel (LAG).

### 6.2.10.2 port-channel

This command configures a new port-channel (LAG) and generates a logical slot and port number for it. Display this number using the **show port-channel**.

**Note:** Before including a port in a port-channel, set the port physical mode. See **speed** command.

#### Syntax

```
port-channel <name>  
no port-channel {<logical slot/port> | all}
```

**<logical slot/port>** - Port-Channel Interface number.

**<name>** - Port-Channel name (up to 15 alphanumeric characters).

**all** - all Port-Channel interfaces.

**no** - This command removes that Port-Channel.

### Default Setting



None

**Command Mode**

Global Config

**Command Usage**

1. Max number of port-channels could be created by user are 6 and Max. Number of members for each port-channel are 8.

**6.2.10.3 port-channel adminmode all**

This command sets every configured port-channel with the same administrative mode setting.

**Syntax**

```
port-channel adminmode all
no port-channel adminmode all
```

**no** - This command disables a port-channel (LAG). The option **all** sets every configured port-channel with the same administrative mode setting.

**Default Setting**

Enabled

**Command Mode**

Global Config

**6.2.10.4 staticcapability**

This command enables the static function to support on specific port-channel (static link aggregations - LAGs) on the device. By default, the static capability for all of port-channels is disabled.

**Syntax**

```
staticcapability
no staticcapability
```

**no** - This command disables to support static function on specific port-channel on this device.

**Default Setting**

Disabled

**Command Mode**

Interface Config

**6.2.10.5 port-channel linktrap**

This command enables link trap notifications for the port-channel (LAG). The interface is a logical slot and port for a configured port-channel. The option **all** sets every configured port-channel with the same administrative mode setting.

**Syntax**

```
port-channel linktrap {<logical slot/port> | all}  
no port-channel linktrap {<logical slot/port> | all}
```

**<logical slot/port>** - Port-Channel Interface number.

**all** - all Port-Channel interfaces.

**no** - This command disables link trap notifications for the port-channel (LAG). The interface is a logical slot and port for a configured port-channel. The option **all** sets every configured port-channel with the same administrative mode setting.

**Default Setting**

Enabled

**Command Mode**

Global Config

**6.2.10.6 port-channel load-balance**

This command for CLI will configured the mode of load balance on the all Port Channels. The parameter "**src-mac | dst-mac | dst-src-mac | src-ip | dst-ip | dst-src-ip**" represent the mode

used to be set for port-channel load balance.

**Syntax**

```
port-channel load-balance all { src-mac | dst-mac | dst-src-mac | src-ip | dst-ip |  
dst-src-ip }  
no port-channel load-balance all
```

**src-mac** - Sets the mode on the source MAC address.

**dst-mac** - Sets the mode on the destination MAC address.

**dst-src-mac** - Sets the mode on the source and destination MAC addresses.

**src-ip** - Sets the mode on the source IP address.

**dst-ip** - Sets the mode on the destination IP address.

**dst-src-ip** - Sets the mode on the source and destination IP addresses.

**no** - Restore the mode to be default value.

**Default Setting**

dst-src-ip

**Command Mode**

Global Config

This command for CLI will configured the mode of load balance on the specific Port Channel. The parameter “**src-mac | dst-mac | dst-src-mac | src-ip | dst-ip | dst-src-ip**” represent the mode used to be set for port-channel load balance.

**Syntax**

```
load-balance { src-mac | dst-mac | dst-src-mac | src-ip | dst-ip | dst-src-ip }  
no load-balance
```

**src-mac** - Sets the mode on the source MAC address.

**dst-mac** - Sets the mode on the destination MAC address.

**dst-src-mac** - Sets the mode on the source and destination MAC addresses.

**src-ip** - Sets the mode on the source IP address.

**dst-ip** - Sets the mode on the destination IP address.

**dst-src-ip** - Sets the mode on the source and destination IP addresses.

**no** - Restore the mode to be default value.

### Default Setting

dst-src-ip

### Command Mode

Interface Config

## 6.2.10.7 port-channel name

This command defines a name for the port-channel (LAG). The interface is a logical slot and port for a configured port-channel, and name is an alphanumeric string up to 15 characters. This command is used to modify the name that was associated with the port-channel when it was created.

### Syntax

```
port-channel name {<logical slot/port> | all} <name>
```

**<logical slot/port>** - Port-Channel Interface number.

**all** - all Port-Channel interfaces.

**<name>** - Configured Port-Channel name (up to 15 characters).

### Default Setting

None

### Command Mode

Global Config

## 6.2.10.8 adminmode

This command enables a port-channel (LAG) members. The interface is a logical slot and port for a configured port-channel.

**Syntax**

```
adminmode  
no adminmode
```

**no** - This command disables a configured port-channel (LAG).

**Default Setting**

Enabled

**Command Mode**

Interface Config

**6.2.10.9 lacp**

This command enables Link Aggregation Control Protocol (LACP) on a port.

**Syntax**

```
lacp  
no lacp
```

**no** - This command disables Link Aggregation Control Protocol (LACP) on a port.

**Default Setting**

Enabled

**Command Mode**

Interface Config

This command enables Link Aggregation Control Protocol (LACP) on all ports.

**Syntax**

```
lacp all
no lacp all
```

**all** - All interfaces.

**no** - This command disables Link Aggregation Control Protocol (LACP) on all ports.

### Default Setting

Enabled

### Command Mode

Global Config

### 6.2.10.10 channel-group

This command adds one port to the port-channel (LAG). The first interface is a logical slot and port number of a configured port-channel.

**Note:** Before adding a port to a port-channel, set the physical mode of the port. See 'speed' command.

#### Syntax

```
channel-group <logical slot/port>
```

**<logical slot/port>** - Port-Channel Interface number.

### Default Setting

None

### Command Mode

Interface Config

### Command Usage

1. The maximum number of members for each Port-Channel is 6.

### 6.2.10.11 delete-channel-group

This command deletes the port from the port-channel (LAG). The interface is a logical slot and port number of a configured port-channel.

**Syntax**

```
delete-channel-group <logical slot/port>
```

**<logical slot/port>** - Port-Channel Interface number.

**Default Setting**

None

**Command Mode**

Interface Config

This command deletes all configured ports from the port-channel (LAG). The interface is a logical slot and port number of a configured port-channel.

**Syntax**

```
delete-channel-group <logical slot/port> all
```

**<logical slot/port>** - Port-Channel Interface number.

**all** - All members for specific Port-Channel.

**Default Setting**

None

**Command Mode**

Global Config

### 6.2.11 Storm Control

### 6.2.11.1 show storm-control

This command is used to display broadcast storm control information.

**Syntax**

```
show storm-control broadcast
```

**Default Setting**

None

**Command Mode**

Privileged Exec

**Display Message**

**Intf:** Displays interface number.

**Mode:** Displays status of storm control broadcast.

**Level:** Displays level for storm control broadcast.

**Rate:** Displays rate for storm control broadcast.

This command is used to display multicast storm control information.

**Syntax**

```
show storm-control multicast
```

**Default Setting**

None

**Command Mode**

Privileged Exec

**Display Message**

**Intf:** Displays interface number.

**Mode:** Displays status of storm control multicast.

**Level:** Displays level for storm control multicast

**Rate:** Displays rate for storm control multicast.



This command is used to display unicast storm control information

**Syntax**

```
show storm-control unicast
```

**Default Setting**

None

**Command Mode**

Privileged Exec

**Display Message**

**Intf:** Displays interface number.

**Mode:** Displays status of storm control unicast.

**Level:** Displays level for storm control unicast

**Rate:** Displays rate for storm control unicast.

**6.2.11.2 storm-control broadcast**

This command enables broadcast storm recovery mode on the selected interface. If the mode is enabled, broadcast storm recovery with high threshold is implemented. The threshold implementation follows a percentage pattern. If the broadcast traffic on any Ethernet port exceeds the high threshold percentage (as represented in “Broadcast Storm Recovery Thresholds” table) of the link speed, the switch discards the broadcasts traffic until the broadcast traffic returns to the threshold percentage or less. The full implementation is depicted in the “Broadcast Storm Recovery Thresholds” table.

**Syntax**

```
storm-control broadcast  
no storm-control broadcast
```

**no** - This command disables broadcast storm recovery mode on the selected interface. The threshold implementation follows a percentage pattern. If the broadcast traffic on any

Ethernet port exceeds the high threshold percentage (as represented in “Broadcast Storm Recovery Thresholds” table) of the link speed, the switch discards the broadcasts traffic until the broadcast traffic returns to the threshold percentage or less. The full implementation is depicted in the “Broadcast Storm Recovery Thresholds” table.

**Default Setting**

Disabled

**Command Mode**

Interface Config

This command enables broadcast storm recovery mode on all interfaces.

**Syntax**

```
storm-control broadcast  
no storm-control broadcast
```

**no** - This command disables broadcast storm recovery mode on all interfaces.

**Default Setting**

Disabled

**Command Mode**

Global Config

**6.2.11.3 storm-control multicast**

This command enables multicast storm recovery mode on the selected interface.

**Syntax**

```
storm-control multicast  
no storm-control multicast
```

**no** - This command disables multicast storm recovery mode on the selected interface.

**Default Setting**

None

**Command Mode**

Interface Config

This command enables multicast storm recovery mode on all interfaces.

**Syntax**

```
storm-control multicast
no storm-control multicast
```

**no** - This command disables multicast storm recovery mode on all interfaces.

**Default Setting**

None

**Command Mode**

Global Config

**6.2.11.4 storm-control unicast**

This command enables unicast storm recovery mode on the selected interface.

**Syntax**

```
storm-control unicast
no storm-control unicast
```

**no** - This command disables unicast storm recovery mode on the selected interface.

**Default Setting**

None

**Command Mode**

Interface Config

This command enables unicast storm recovery mode on all interfaces.

**Syntax**

```
storm-control unicast  
no storm-control unicast
```

**no** - This command disables unicast storm recovery mode on all interfaces.

**Default Setting**

None

**Command Mode**

Global Config

**6.2.11.5 switchport broadcast packet-rate**

This command will protect your network from broadcast storms by setting a threshold level for broadcast traffic on each port.

**Syntax**

```
switchport broadcast packet-rate {1 | 2 | 3 | 4}
```

- 1 - Threshold level represents 64 pps for 1G Port or 1042 pps for 10G port.
- 2 - Threshold level represents 128 pps for 1G Port or 2084 pps for 10G port.
- 3 - Threshold level represents 256 pps for 1G Port or 3124 pps for 10G port.
- 4 - Threshold level represents 512 pps for 1G Port or 4167 pps for 10G port.

**Note:** pps (packet per second)

**Default Setting**

Level 4

**Command Mode**

Interface Config

This command will protect your network from broadcast storms by setting a threshold level for broadcast traffic on all ports.

**Syntax**

```
switchport broadcast all packet-rate {1 | 2 | 3 | 4}
```

- 1 - Threshold level represents 64 pps for 1G Port or 1042 pps for 10G port.
- 2 - Threshold level represents 128 pps for 1G Port or 2084 pps for 10G port.
- 3 - Threshold level represents 256 pps for 1G Port or 3124 pps for 10G port.
- 4 - Threshold level represents 512 pps for 1G Port or 4167 pps for 10G port.
- all** - This command represents all interfaces.

**Note:** pps (packet per second)

**Default Setting**

Level 4

**Command Mode**

Global Config

**6.2.11.6 switchport multicast packet-rate**

This command will protect your network from multicast storms by setting a threshold level for multicast traffic on each port.

**Syntax**

```
switchport multicast packet-rate {1 | 2 | 3 | 4}
```

- 1 - Threshold level represents 64 pps for 1G Port or 1042 pps for 10G port.
  - 2 - Threshold level represents 128 pps for 1G Port or 2084 pps for 10G port.
  - 3 - Threshold level represents 256 pps for 1G Port or 3124 pps for 10G port.
  - 4 - Threshold level represents 512 pps for 1G Port or 4167 pps for 10G port.
- Note:** pps (packet per second)

### Default Setting

Level 4

### Command Mode

Interface Config

This command will protect your network from multicast storms by setting a threshold level for multicast traffic on all ports.

### Syntax

```
switchport multicast all packet-rate {1 | 2 | 3 | 4}
```

- 1 - Threshold level represents 64 pps for 1G Port or 1042 pps for 10G port.
  - 2 - Threshold level represents 128 pps for 1G Port or 2084 pps for 10G port.
  - 3 - Threshold level represents 256 pps for 1G Port or 3124 pps for 10G port.
  - 4 - Threshold level represents 512 pps for 1G Port or 4167 pps for 10G port.
  - all** - This command represents all interfaces.
- Note:** pps (packet per second)

### Default Setting

Level 4

### Command Mode

Global Config

## 6.2.11.7 switchport unicast packet-rate

This command will protect your network from unicast storms by setting a threshold level for unicast traffic on each port.

**Syntax**

```
switchport unicast packet-rate {1 | 2 | 3 | 4}
```

- 1 - Threshold level represents 64 pps for 1G Port or 1042 pps for 10G port.
  - 2 - Threshold level represents 128 pps for 1G Port or 2084 pps for 10G port.
  - 3 - Threshold level represents 256 pps for 1G Port or 3124 pps for 10G port.
  - 4 - Threshold level represents 512 pps for 1G Port or 4167 pps for 10G port.
- Note:** pps (packet per second)

**Default Setting**

Level 4

**Command Mode**

Interface Config

This command will protect your network from unicast storms by setting a threshold level for unicast traffic on all ports.

**Syntax**

```
switchport unicast all packet-rate {1 | 2 | 3 | 4}
```

- 1 - Threshold level represents 64 pps for 1G Port or 1042 pps for 10G port.
  - 2 - Threshold level represents 128 pps for 1G Port or 2084 pps for 10G port.
  - 3 - Threshold level represents 256 pps for 1G Port or 3124 pps for 10G port.
  - 4 - Threshold level represents 512 pps for 1G Port or 4167 pps for 10G port.
- all** - This command represents all interfaces.
- Note:** pps (packet per second)

**Default Setting**

Level 4

**Command Mode**

Global Config

**6.2.12 L2 Priority****6.2.12.1 show queue cos-map**

This command displays the class of service priority map on specific interface.

**Syntax**

```
show queue cos-map [<slot/port>]
```

<slot/port> - Interface number.

**Default Setting**

None

**Command Mode**

Privileged Exec

**Display Message**

**User Priority:** Displays the 802.1p priority to be mapped.

**Traffic Class:** Displays internal traffic class to map the corresponding 802.1p priority.

**6.2.12.2 queue cos-map**

This command is used to assign class of service (CoS) value to the CoS priority queue.

**Syntax**

```
queue cos-map <priority> <queue-id>  
no queue cos-map
```

<queue-id> - The queue id of the CoS priority queue (Range: 0 - 7).

<priority> - The CoS value that is mapped to the queue id (Range: 0 - 7).

**no** - Sets the CoS map to the default values.



**Default Setting**

priority	queue
0	1
1	0
2	0
3	1
4	2
5	2
6	3
7	3

**Command Mode**

Interface Config

**6.2.13 Port Mirror****6.2.13.1 show port-monitor session**

This command displays the Port monitoring information for the specified session.

**Syntax**

```
show port-monitor session <Session Number>
```

< Session Number > - session number.

**Default Setting**

None

**Command Mode**

Privileged Exec

**Display Message**

**Session ID:** indicates the session ID.

**Admin Mode:** indicates whether the Port Monitoring feature is enabled or disabled. The possible values are enabled and disabled.

**Dest.Port:** is the slot/port that is configured as the probe port. If this value has not been configured, 'Not Configured' will be displayed.

**Sour.Port:** is the slot/port that is configured as the monitored port. If this value has not been configured, 'Not Configured' will be displayed.

**Type:** Direction in which source port configured for port mirroring. Types are tx for transmitted packets and rx for receiving packets.

### 6.2.13.2 port-monitor session

This command configures a probe port and a monitored port for monitor session (port monitoring). Use the source interface <slot/port> parameter to specify the interface to monitor. Use rx to monitor only ingress packets, or use tx to monitor only egress packets. If you do not specify an {rx | tx} option, the destination port monitors both ingress and egress packets. Use the destination interface <slot/port> to specify the interface to receive the monitored traffic.

#### Syntax

```
port-monitor session <session-id> {source interface <slot/port> [{rx | tx}] | destination interface <slot/port> }
```

```
no port-monitor session <session-id> { source interface <slot/port> | destination interface <slot/port> }
```

**<slot/port>** - Interface number.

**tx/rx** – Use to monitor ingress packets or egress packets.

**no** - This command removes the probe port or the mirrored port from a monitor session (port monitoring).

#### Default Setting

None

#### Command Mode

Global Config

This command removes all configured probe ports and mirrored port.

#### Syntax

```
no port-monitor
```

**Default Setting**

None

**Command Mode**

Global Config

**6.2.13.3 port-monitor session mode**

This command configures the mode parameter to enabled the administrative mode of the session. If enabled, the probe port monitors all the traffic received and transmitted on the physical monitored port.

**Syntax**

```
port-monitor session <session-id> mode  
no port-monitor session <session-id> mode
```

**<session-id>** - Session ID.

**no** - This command disables port-monitoring function for a monitor session.

**6.3 Management Commands****6.3.1 Network Commands****6.3.1.1 show ip interface**

This command displays configuration settings associated with the switch's network interface. The network interface is the logical interface used for in-band connectivity with the switch via any of the switch's front panel ports. The configuration parameters associated with the switch's network interface do not affect the configuration of the front panel ports through which traffic is switched or routed.

**Syntax**

```
show ip interface
```

**Default Setting**

None

**Command Mode**

Privileged Exec

**Display Message****IP Address:** The IP address of the interface. The factory default value is 0.0.0.0**Subnet Mask:** The IP subnet mask for this interface. The factory default value is 0.0.0.0**Default Gateway:** The default gateway for this IP interface. The factory default value is 0.0.0.0**Burned In MAC Address:** The burned in MAC address used for in-band connectivity.**Network Configuration Protocol Current:** Indicates which network protocol is being used. The options are bootp | dhcp | none.**DHCP Client Identifier TEXT:** DHCP client identifier in TEXT mode for this switch.**DHCP Client Identifier HEX:** DHCP client identifier in HEX address for this switch.**Management VLAN ID:** Specifies the management VLAN ID.**Web Mode:** Specifies whether the switch may be accessed from a Web browser. The factory default is enabled.**Web Port:** This field is used to set the HTTP Port Number. The value must be in the range of 1 to 65535. Port 80 is the default value.**Java Mode:** Specifies if the switch should allow access to the Java applet in the header frame. Enabled means the applet can be viewed. The factory default is disabled.**6.3.1.2 show ip filter**

This command displays management IP filter status and all designated management stations.

**Syntax**

```
show ip filter
```

**Default Setting**

None

**Command Mode**

Privileged Exec

**Display Message****Manegement IP Filter Address Table:** The admin mode status for IP filter.**Index:** The index of stations.

**IP Address:** The IP address of stations that are allowed to make configuration changes to the Switch.

### 6.3.1.3 mtu

This command sets the maximum transmission unit (MTU) size (in bytes) for physical and port-channel (LAG) interfaces. For the standard implementation, the range of <1518-9216> is a valid integer between 1518-9216.

<b>Syntax</b>
---------------

<b>mtu &lt;1518-9216&gt;</b> <b>no mtu</b>
---

<1518-9216> - Max frame size (Range: 1518 - 9216).

**no** - This command sets the default maximum transmission unit (MTU) size (in bytes) for the interface.

#### Default Setting

1518

#### Command Mode

Interface Config

### 6.3.1.4 interface vlan

This command is used to enter Interface-vlan configuration mode.

<b>Syntax</b>
---------------

<b>interface vlan &lt;vlanid&gt;</b>
--------------------------------------

<vlanid> - VLAN ID (Range: 1 - 3965).

#### Default Setting

None

**Command Mode**

Global Config

**6.3.1.5 ip address**

This command sets the IP Address, and subnet mask. The IP Address and the gateway must be on the same subnet.

**Syntax**

```
ip address <ipaddr> <netmask>  
no ip address
```

**<ipaddr>** - IP address

**<netmask>** - Subnet Mask

**no** - Restore the default IP address and Subnet Mask

**Default Setting**

IP address: 0.0.0.0

Subnet Mask: 0.0.0.0

**Command Mode**

Interface-Vlan Config

**Command Usage**

Once the IP address is set, the VLAN ID's value will be assigned to management VLAN.

**6.3.1.6 ip default-gateway**

This command sets the IP Address of the default gateway.

**Syntax**

```
ip default-gateway <gateway>  
no ip default-gateway
```

**< gateway >** - IP address of the default gateway

**no** - Restore the default IP address of the default gateway

### Default Setting

IP address: 0.0.0.0

### Command Mode

Global Config

## 6.3.1.7 ip address protocol

This command specifies the network configuration protocol to be used. If you modify this value, the change is effective immediately.

<b>Syntax</b>
---------------

<b>ip address protocol {bootp   dhcp   none}</b>
--

**<bootp>** - Obtains IP address from BOOTP.

**<dhcp>** - Obtains IP address from DHCP.

**<none>** - Obtains IP address by setting configuration.

### Default Setting

None

### Command Mode

Interface-Vlan Config

## 6.3.1.8 ip filter

This command is used to enable the IP filter function.

**Syntax**

```
ip filter
no ip filter
```

**no** – Disable ip filter.

**Default Setting**

Disabled

**Command Mode**

Global Config

This command is used to set an IP address to be a filter.

**Syntax**

```
ip filter <ipaddr>
no ip filter <ipaddr>
```

**<ipaddr>** - Configure a IP address to be a filter.

**No** - Remove this filter IP address.

**Default Setting**

None

**Command Mode**

Global Config

## 6.3.2 Serial Interface Commands

### 6.3.2.1 show line console

This command displays serial communication settings for the switch.



**Syntax**

```
show line console
```

**Default Setting**

None

**Command Mode**

Privileged Exec

**Display Message**

**Serial Port Login Timeout (minutes):** Specifies the time, in minutes, of inactivity on a Serial port connection, after which the Switch will close the connection. Any numeric value between 0 and 160 is allowed, the factory default is 5. A value of 0 disables the timeout.

**Baud Rate:** The default baud rate at which the serial port will try to connect. The available values are 1200, 2400, 4800, 9600, 19200, 38400, 57600, and 115200 bauds.

**Character Size:** The number of bits in a character. The number of bits is always 8.

**Flow Control:** Whether Hardware Flow-Control is enabled or disabled. Hardware Flow Control is always disabled.

**Stop Bits:** The number of Stop bits per character. The number of Stop bits is always 1.

**Parity:** The Parity Method used on the Serial Port. The Parity Method is always None.

**Password Threshold:** When the logon attempt threshold is reached on the console port, the system interface becomes silent for a specified amount of time before allowing the next logon attempt. (Use the silent time command to set this interval.) When this threshold is reached for Telnet, the Telnet logon interface closes.

**Silent Time (sec):** Use this command to set the amount of time the management console is inaccessible after the number of unsuccessful logon attempts exceeds the threshold set by the password threshold command.

**Terminal Length:** The columns per page for terminal serial port.

### 6.3.2.2 line console

This command is used to enter Line configuration mode

**Syntax**

```
line console
```

**Default Setting**

None

**Command Mode**

Global Config

### 6.3.2.3 baudrate

This command specifies the communication rate of the terminal interface. The supported rates are 1200, 2400, 4800, 9600, 19200, 38400, 57600, 115200.

#### Syntax

```
baudrate {1200 | 2400 | 4800 | 9600 | 19200 | 38400 | 57600 | 115200}  
no baudrate
```

**no** - This command sets the communication rate of the terminal interface to **115200**.

#### Default Setting

115200

#### Command Mode

Line Config

### 6.3.2.4 exec-timeout

This command specifies the maximum connect time (in minutes) without console activity. A value of 0 indicates that a console can be connected indefinitely. The time range is 0 to 160.

#### Syntax

```
exec-timeout <0-160>
```

**<0-160>** - max connect time (Range: 0 -160), 0: forever.

**no** - This command sets the maximum connect time (in minutes) without console activity to 5.

#### Default Setting

5

#### Command Mode

Line Config

### 6.3.2.5 password-threshold

This command is used to set the password instruction threshold limiting the number of failed login attempts.

#### Syntax

```
password-threshold <0-120>  
no password-threshold
```

**<threshold>** - max threshold (Range: 0 - 120).

**no** - This command sets the maximum value to the default.

#### Default Setting

3

#### Command Mode

Line Config

### 6.3.2.6 silent-time

This command uses to set the amount of time the management console is inaccessible after the number of unsuccessful logon tries exceeds the threshold value.

#### Syntax

```
silent-time <0-65535>
```

**<0-65535>** - silent time (Range: 0 - 65535) in seconds.

**no** - This command sets the maximum value to the default.

#### Default Setting

0

#### Command Mode

Line Config

### 6.3.2.7 terminal length

This command uses to configure the columns per page for the management console.

#### Syntax

```
terminal-length <10-100>
```

**<10-100>** - Columns per page (Range: 10 - 100).

**no** - This command sets the value to the default.

#### Default Setting

24

#### Command Mode

Line Config

## 6.3.3 Telnet Session Commands

### 6.3.3.1 telnet

This command establishes a new outbound telnet connection to a remote host.

#### Syntax

```
telnet <host> [port] [debug] [line] [echo]
```

**<host>** - A hostname or a valid IP address.

**[port]** - A valid decimal integer in the range of 0 to 65535, where the default value is 23.

**[debug]** - Display current enabled telnet options.

**[line]** - Set the outbound telnet operational mode as 'linemode', where by default, the operational mode is 'character mode'.

**[echo]** - Enable local echo.

**Default Setting**

None

**Command Mode**

Privileged Exec

**6.3.3.2 show line vty**

This command displays telnet settings.

**Syntax**

```
show line vty
```

**Default Setting**

None

**Command Mode**

Privileged Exec

**Display Message**

**Remote Connection Login Timeout (minutes):** This object indicates the number of minutes a remote connection session is allowed to remain inactive before being logged off. A zero means there will be no timeout. May be specified as a number from 0 to 160. The factory default is 5.

**Maximum Number of Remote Connection Sessions:** This object indicates the number of simultaneous remote connection sessions allowed. The factory default is 5.

**Allow New Telnet Sessions:** Indicates that new telnet sessions will not be allowed when set to no. The factory default value is yes.

**Password Threshold:** When the logon attempt threshold is reached on the console port, the system interface becomes silent for a specified amount of time before allowing the next logon attempt. (Use the silent time command to set this interval.) When this threshold is reached for Telnet, the Telnet logon interface closes.

**Telnet Server Admin Mode:** The telnet server admin mode status. The factory default is enable

**Terminal Length:** The columns per page for terminal vty port.

**6.3.3.3 line vty**

This command is used to enter vty (Telnet) configuration mode.

**Syntax**

```
line vty
```

**Default Setting**

None

**Command Mode**

Global Config

**6.3.3.4 exec-timeout**

This command sets the remote connection session timeout value, in minutes. A session is active as long as the session has been idle for the value set. A value of 0 indicates that a session remains active indefinitely. The time is a decimal value from 0 to 160.

**Note:** Changing the timeout value for active sessions does not become effective until the session is reaccessed. Any keystroke will also activate the new timeout duration.

**Syntax**

```
exec-timeout <1-160>
```

```
no exec-timeout
```

**<sec>** - max connect time (Range: 1 -160).

**no** - This command sets the remote connection session timeout value, in minutes, to the default.

**Note:** Changing the timeout value for active sessions does not become effective until the session is reaccessed. Any keystroke will also activate the new timeout duration.

**Default Setting**

5

**Command Mode**

Telnet Config

### 6.3.3.5 password-threshold

This command is used to set the password instruction threshold limited for the number of failed login attempts.

<b>Syntax</b>
---------------

<b>password-threshold &lt;0-120&gt;</b> <b>no password-threshold</b>
---

**<threshold>** - max threshold (Range: 0 - 120).

**no** - This command sets the maximum value to the default.

#### Default Setting

3

#### Command Mode

Telnet Config

### 6.3.3.6 terminal length

This command uses to configure the columns per page for the vty session.

<b>Syntax</b>
---------------

<b>terminal-length &lt;10-100&gt;</b>
---------------------------------------

**<10-100>** - Columns per page (Range: 10 - 100).

**no** - This command sets the value to the default.

#### Default Setting

24

#### Command Mode

Telnet Config

### 6.3.3.7 maxsessions

This command specifies the maximum number of remote connection sessions that can be established. A value of 0 indicates that no remote connection can be established. The range is 0 to 5.

**Syntax**

```
maxsessions <0-5>  
no maxsessions
```

**<0-5>** - max sessions (Range: 0 - 5).

**no** - This command sets the maximum value to be 5.

**Default Setting**

5

**Command Mode**

Telnet Config

**6.3.3.8 server enable**

This command enables/disables telnet server. If telnet server is enabled, all telnet sessions can be established until there are no more sessions available. If telnet server is disabled, all telnet sessions are closed.

**Syntax**

```
server enable  
no server enable
```

**no** - This command disables telnet server. If telnet server is disabled, all telnet sessions are dropped.

**Default Setting**

Enabled

**Command Mode**

Telnet Config

**6.3.3.9 sessions**



This command regulates new telnet sessions. If sessions are enabled, new telnet sessions can be established until there are no more sessions available. If sessions are disabled, no new telnet sessions are established. An established session remains active until the session is ended or an abnormal network error ends it.

**Syntax**

```
sessions  
no sessions
```

**no** - This command disables telnet sessions. If sessions are disabled, no new telnet sessions are established.

**Default Setting**

Enabled

**Command Mode**

Telnet Config

**6.3.3.10 telnet sessions**

This command regulates new outbound telnet connections. If enabled, new outbound telnet sessions can be established until it reaches the maximum number of simultaneous outbound telnet sessions allowed. If disabled, no new outbound telnet session can be established. An established session remains active until the session is ended or an abnormal network error ends it.

**Syntax**

```
telnet sessions  
no telnet sessions
```

**no** - This command disables new outbound telnet connections. If disabled, no new outbound telnet connection can be established.

**Default Setting**

Enabled

**Command Mode**

Global Config

### 6.3.3.11 telnet maxsessions

This command specifies the maximum number of simultaneous outbound telnet sessions. A value of 0 indicates that no outbound telnet session can be established.

**Syntax**

```
telnet maxsessions <0-5>  
no maxsessions
```

**<0-5>** - max sessions (Range: 0 - 5).

**no** - This command sets the maximum value to be 5.

**Default Setting**

5

**Command Mode**

Global Config

### 6.3.3.12 telnet exec-timeout

This command sets the outbound telnet session timeout value in minute.

**Note:** Changing the timeout value for active sessions does not become effective until the session is reaccessed. Any keystroke will also activate the new timeout duration.

**Syntax**

```
telnet exec-timeout <1-160>  
no telnet exec-timeout
```

**<1-160>** - max connect time (Range: 1 -160).

**no** - This command sets the remote connection session timeout value, in minutes, to the default.

**Note:** Changing the timeout value for active sessions does not become effective until the session is reaccessed. Any keystroke will also activate the new timeout duration.

**Default Setting**

5

**Command Mode**

Global Config

**6.3.3.13 show telnet**

This command displays the current outbound telnet settings.

**Syntax**

```
show telnet
```

**Default Setting**

None

**Command Mode**

User Exec, Privileged Exec

**Display Message**

**Outbound Telnet Login Timeout (in minutes)** Indicates the number of minutes an outbound telnet session is allowed to remain inactive before being logged off. A value of 0, which is the default, results in no timeout.

**Maximum Number of Outbound Telnet Sessions** Indicates the number of simultaneous outbound telnet connections allowed.

**Allow New Outbound Telnet Sessions** Indicates whether outbound telnet sessions will be allowed.

### 6.3.4 SNMP Server Commands

#### 6.3.4.1 show snmp

This command displays SNMP community information.

Six communities are supported. You can add, change, or delete communities. The switch does not have to be reset for changes to take effect.

The SNMP agent of the switch complies with SNMP versions 1, 2c, and 3 (for more about the SNMP specification, see the SNMP RFCs). The SNMP agent sends traps through TCP/IP to an external SNMP manager based on the SNMP configuration (the trap receiver and other SNMP community parameters).

<b>Syntax</b>
<code>show snmp</code>

#### Default Setting

None

#### Command Mode

Privileged Exec

#### Display Message

**SNMP Community Name:** The community string to which this entry grants access. A valid entry is a case-sensitive alphanumeric string of up to 16 characters. Each row of this table must contain a unique community name.

**Client IP Address:** An IP address (or portion thereof) from which this device will accept SNMP packets with the associated community. The requesting entity's IP address is ANDed with the Subnet Mask before being compared to the IP Address. Note: that if the Subnet Mask is set to 0.0.0.0, an IP Address of 0.0.0.0 matches all IP addresses. The default value is 0.0.0.0

**Client IP Mask:** A mask to be ANDed with the requesting entity's IP address before comparison with IP Address. If the result matches with the IP Address then the address is an authenticated IP address. For example, if the IP Address = 9.47.128.0 and the corresponding Subnet Mask = 255.255.255.0, a range of incoming IP addresses would match. That is, the incoming IP Address could equal 9.47.128.0 - 9.47.128.255. The default value is 0.0.0.0.

**Access Mode:** The access level for this community string.

**Status:** The status of this community access entry.

#### 6.3.4.2 show trapflags

This command displays trap conditions. Configure which traps the switch should generate by enabling or disabling the trap condition. If a trap condition is enabled and the condition is detected, the switch's SNMP agent sends the trap to all enabled trap receivers. The switch does not have to be reset to implement the changes. Cold and warm start traps are always generated and cannot be disabled.

**Syntax**

```
show trapflags
```

**Default Setting**

None

**Command Mode**

Privileged Exec

**Display Message**

**Authentication Flag:** May be enabled or disabled. The factory default is enabled. Indicates whether authentication failure traps will be sent.

**Link Up/Down Flag:** May be enabled or disabled. The factory default is enabled. Indicates whether link status traps will be sent.

**Multiple Users Flag:** May be enabled or disabled. The factory default is enabled. Indicates whether a trap will be sent when the same user ID is logged into the switch more than once at the same time (either via telnet or serial port).

**Spanning Tree Flag:** May be enabled or disabled. The factory default is enabled. Indicates whether spanning tree traps will be sent.

**DVMRP Traps** May be enabled or disabled. The factory default is disabled. Indicates whether DVMRP traps will be sent.

**OSPF Traps** May be enabled or disabled. The factory default is disabled. Indicates whether OSPF traps will be sent.

**PIM Traps** May be enabled or disabled. The factory default is disabled. Indicates whether PIM traps will be sent.

### 6.3.4.3 snmp-server sysname

This command sets the name of the switch. The range for name is from 1 to 31 alphanumeric characters.

**Syntax**

```
snmp-server sysname <name>
```

**<name>** - Range is from 1 to 31 alphanumeric characters.

**Default Setting**

None

**Command Mode**

Global Config

**6.3.4.4 snmp-server location**

This command sets the physical location of the switch. The range for name is from 1 to 31 alphanumeric characters.

**Syntax**

```
snmp-server location <loc>
```

**<loc>** - range is from 1 to 31 alphanumeric characters.

**Default Setting**

None

**Command Mode**

Global Config

**6.3.4.5 snmp-server contact**

This command sets the organization responsible for the network. The range for contact is from 1 to 31 alphanumeric characters.

**Syntax**

```
snmp-server contact <con>
```

**<con>** - Range is from 1 to 31 alphanumeric characters.

**Default Setting**

None

**Command Mode**

Global Config

**6.3.4.6 snmp-server community**

This command adds (and names) a new SNMP community. A community name is a name associated with the switch and with a set of SNMP managers that manage it with a specified privilege level. The length of the name can be up to 16 case-sensitive characters.

**Note:** Community names in the SNMP community table must be unique. If you make multiple entries using the same community name, the first entry is kept and processed and all duplicate entries are ignored.

**Syntax**

```
snmp-server community <name>  
no snmp-server community <name>
```

**<name>** - community name (up to 16 case-sensitive characters).

**no** - This command removes this community name from the table. The name is the community name to be deleted.

**Default Setting**

Two default community names: public and private. You can replace these default community names with unique identifiers for each community. The default values for the remaining four community names are blank.

**Command Mode**

Global Config

This command activates an SNMP community. If a community is enabled, an SNMP manager associated with this community manages the switch according to its access right. If the community is disabled, no SNMP requests using this community are accepted. In this case the SNMP manager associated with this community cannot manage the switch until the Status is changed back to Enable.

**Syntax**

```
snmp-server community mode <name>  
no snmp-server community mode <name>
```

**<name>** - community name.

**no** - This command deactivates an SNMP community. If the community is disabled, no SNMP requests using this community are accepted. In this case the SNMP manager associated with this community cannot manage the switch until the Status is changed back to Enable.

**Default Setting**

The default public and private communities are enabled by default. The four undefined communities are disabled by default.

**Command Mode**

Global Config

This command sets a client IP mask for an SNMP community. The address is the associated community SNMP packet sending address and is used along with the client IP address value to denote a range of IP addresses from which SNMP clients may use that community to access the device. A value of 255.255.255.255 will allow access from only one station, and will use that machine's IP address for the client IP Address. A value of 0.0.0.0 will allow access from any IP address. The name is the applicable community name.

**Syntax**

```
snmp-server community ipmask <ipmask> <name>  
no snmp-server community ipmask <name>
```



**<name>** - community name.

**<ipmask>** - a client IP mask.

**no** - This command sets a client IP mask for an SNMP community to **0.0.0.0**. The name is the applicable community name. The community name may be up to 16 alphanumeric characters.

#### Default Setting

0.0.0.0

#### Command Mode

Global Config

This command restricts access to switch information. The access mode is read-only (also called public) or read/write (also called private).

<b>Syntax</b>
---------------

<b>snmp-server community {ro   rw} &lt;name&gt;</b>
---

**<name>** - community name.

**<ro>** - access mode is read-only.

**<rw>** - access mode is read/write.

#### Default Setting

None

#### Command Mode

Global Config

### 6.3.4.7 snmp-server host

This command sets a client IP address for an SNMP community. The address is the associated community SNMP packet sending address and is used along with the client IP mask value to denote a range of IP addresses from which SNMP clients may use that community to access the device. A value of 0.0.0.0 allows access from any IP address. Otherwise, this value is

ANDed with the mask to determine the range of allowed client IP addresses. The name is the applicable community name.

**Syntax**

```
snmp-server host <ipaddr> <name>  
no snmp-server host <name>
```

**<name>** - community name.

**<ipaddr>** - a client IP address.

**no** - This command sets a client IP address for an SNMP community to **0.0.0.0**. The name is the applicable community name.

**Default Setting**

0.0.0.0

**Command Mode**

Global Config

**6.3.4.8 snmp-server enable traps**

This command enables the acl trap.

**Syntax**

```
snmp-server enable traps acl-trapflags  
no snmp-server enable traps acl-trapflags
```

**no** - This command disables the acl trap.

**Default Setting**

Enabled

**Command Mode**

Global Config

This command enables the Authentication trap.

**Syntax**

```
snmp-server enable traps authentication  
no snmp-server enable traps authentication
```

**no** - This command disables the Authentication trap.

**Default Setting**

Enabled

**Command Mode**

Global Config

This command enables the DVMRP trap.

**Syntax**

```
snmp-server enable traps dvmrp  
no snmp-server enable traps dvmrp
```

**no** - This command disables the DVMRP trap.

**Default Setting**

Enabled

**Command Mode**

Global Config

This command enables Link Up/Down traps for the entire switch. When enabled, link traps are sent only if the Link Trap flag setting associated with the port is enabled (see 'snmp trap

link-status' command).

**Syntax**

```
snmp-server enable traps linkmode  
no snmp-server enable traps linkmode
```

**no** - This command disables Link Up/Down traps for the entire switch.

**Default Setting**

Enabled

**Command Mode**

Global Config

This command enables Multiple User traps. When the traps are enabled, a Multiple User Trap is sent when a user logs in to the terminal interface (EIA 232 or telnet) and there is an existing terminal interface session.

**Syntax**

```
snmp-server enable traps multiusers  
no snmp-server enable traps multiusers
```

**no** - This command disables Multiple User trap.

**Default Setting**

Enabled

**Command Mode**

Global Config

This command enables OSPF traps.

**Syntax**

```
snmp-server enable traps ospf
no snmp-server enable traps ospf
```

**no** - This command disables OSPF trap.

**Default Setting**

Enabled

**Command Mode**

Global Config

This command enables OSPFv3 traps.

**Syntax**

```
snmp-server enable traps ospfv3
no snmp-server enable traps ospfv3
```

**no** - This command disables OSPFv3 trap.

**Default Setting**

Enabled

**Command Mode**

Global Config

This command enables PIM traps.

**Syntax**

```
snmp-server enable traps pim
no snmp-server enable traps pim
```

**no** - This command disables PIM trap.

**Default Setting**

Enabled

**Command Mode**

Global Config

This command enables the sending of new root traps and topology change notification traps.

**Syntax**

```
snmp-server enable traps stpmode
no snmp-server enable traps stpmode
```

**no** - This command disables the sending of new root traps and topology change notification traps.

**Default Setting**

Enabled

**Command Mode**

Global Config

This command Enables/Disables SNMP violation traps for interface.

**Syntax**

```
snmp-server enable traps violation
no snmp-server enable traps violation
```

**no** - This command disables the sending of violation traps notification traps.

**Default Setting**

Enabled

**Command Mode**

Interface Config

**6.3.5 SNMP Trap Commands****6.3.5.1 show snmptrap**

This command displays SNMP trap receivers. Trap messages are sent across a network to an SNMP Network Manager. These messages alert the manager to events occurring within the switch or on the network. Six trap receivers are simultaneously supported.

**Syntax**

```
show snmptrap
```

**Default Setting**

None

**Command Mode**

Privileged Exec

**Display Message**

**SNMP Trap Name:** The community string of the SNMP trap packet sent to the trap manager. This may be up to 16 alphanumeric characters. This string is case sensitive.

**IP Address:** The IP address to receive SNMP traps from this device. Enter 4 numbers between 0 and 255 separated by periods.

**SNMP Version:** The trap version to be used by the receiver.

**SNMP v1** – Uses SNMP v1 to send traps to the receiver

**SNMP v2** – Uses SNMP v2 to send traps to the receiver

**Status:** A pull down menu that indicates the receiver's status (enabled or disabled) and allows the administrator/user to perform actions on this user entry:

**Enable:** send traps to the receiver

**Disable:** do not send traps to the receiver.

**Delete:** remove the table entry.

**6.3.5.2 snmptrap snmpversion**

This command configures the version for snmp trap.

**Syntax**

```
snmptrap snmpversion <name> <ipaddr> <snmpversion>
```

**Default Setting**

Snmpv2

**Command Mode**

Global Config

**6.3.5.3 snmptrap link-status**

This command enables link status traps by interface.

**Note:** This command is valid only when the Link Up/Down Flag is enabled. See 'snmpserver enable traps linkmode' command.

**Syntax**

```
snmptrap link-status  
no snmptrap link-status
```

**no** - This command disables link status traps by interface.

**Note:** This command is valid only when the Link Up/Down Flag is enabled. (See 'snmpserver enable traps linkmode' command.)

**Default Setting**

Disabled

**Command Mode**

Interface Config



This command enables link status traps for all interfaces.

**Note:** This command is valid only when the Link Up/Down Flag is enabled (See ‘snmpserver enable traps linkmode’ command.)

**Syntax**

```
snmptrap link-status all
no snmptrap link-status all
```

**all** - All interfaces.

**no** - This command disables link status traps for all interfaces.

**Note:** This command is valid only when the Link Up/Down Flag is enabled (see “snmpserver enable traps linkmode”).

**Default Setting**

Disabled

**Command Mode**

Global Config

**6.3.5.4 snmptrap <name> <ipaddr> <snmpversion>**

This command adds an SNMP trap name. The maximum length of the name is 16 case-sensitive alphanumeric characters.

**Syntax**

```
snmptrap <name> <ipaddr> <snmpversion>
no snmptrap <name> <ipaddr> <snmpversion>
```

**<name>** - SNMP trap name (Range: up to 16 case-sensitive alphanumeric characters).

**<ipaddr>** - an IP address of the trap receiver.

**<snmpversion>** - SNMP trap version.

**no** - This command deletes trap receivers for a community.

**Default Setting**

None

**Command Mode**

Global Config

**6.3.5.5 snmptrap ipaddr**

This command changes the IP address of the trap receiver for the specified community name. The maximum length of name is 16 case-sensitive alphanumeric characters.

**Note:** IP addresses in the SNMP trap receiver table must be unique for the same community name. If you make multiple entries using the same IP address and community name, the first entry is retained and processed. All duplicate entries are ignored.

**Syntax**

```
snmptrap ipaddr <name> <ipaddr> <ipaddrnew>
```

**<name>** - SNMP trap name.

**<ipaddr>** - an original IP address.

**<ipaddrnew>** - a new IP address.

**Default Setting**

None

**Command Mode**

Global Config

**6.3.5.6 snmptrap mode**

This command activates or deactivates an SNMP trap. Enabled trap receivers are active (able to receive traps). Disabled trap receivers are inactive (not able to receive traps).

**Syntax**

```
snmptrap mode <name> <ipaddr>  
no snmptrap mode <name> <ipaddr>
```

**<name>** - SNMP trap name.

**<ipaddr>** - an IP address.

**no** - This command deactivates an SNMP trap. Trap receivers are inactive (not able to receive traps).

### Default Setting

None

### Command Mode

Global Config

## 6.3.6 HTTP commands

### 6.3.6.1 show ip http

This command displays the http settings for the switch.

<b>Syntax</b>
---------------

<pre>show ip http</pre>
-------------------------

### Default Setting

None

### Command Mode

Privileged Exec

### Display Message

**HTTP Mode (Unsecure):** This field indicates whether the HTTP mode is enabled or disabled.

**HTTP Port:** This field specifies the port configured for HTTP.

**HTTP Mode (Secure):** This field indicates whether the administrative mode of secure HTTP is enabled or disabled.

**Secure Port:** This field specifies the port configured for SSLT.

**Secure Protocol Level(s):** The protocol level may have the values of SSL3, TSL1, or both

SSL3 and TSL1.

**Hard-timeout:** Display the hard timeout for secure HTTP sessions in hours.

**Soft-timeout:** Display the soft timeout for HTTP sessions in minutes.

**Max-sessions:** Display the number of allowable HTTP sessions.

**Secure-hard-timeout:** Display the hard timeout for secure HTTP sessions in hours.

**Secure-soft-timeout:** Display the soft timeout for HTTP sessions in minutes.

**Secure-max-sessions:** Display the number of allowable HTTP sessions.

### 6.3.6.2 ip javamode

This command specifies whether the switch should allow access to the Java applet in the header frame of the Web interface. When access is enabled, the Java applet can be viewed from the Web interface. When access is disabled, the user cannot view the Java applet.

#### Syntax

```
ip javamode
no ip javamode
```

**no** - This command disallows access to the Java applet in the header frame of the Web interface. When access is disabled, the user cannot view the Java applet.

#### Default Setting

Enabled

#### Command Mode

Global Config

### 6.3.6.3 ip http port

This command is used to set the http port where port can be 1-65535 and the default is port 80.

#### Syntax

```
ip http port <1-65535>
no ip http port
```

<1-65535> - HTTP Port value.

**no** - This command is used to reset the http port to the default value.

### Default Setting

80

### Command Mode

Global Config

#### 6.3.6.4 ip http server

This command enables access to the switch through the Web interface. When access is enabled, the user can login to the switch from the Web interface. When access is disabled, the user cannot login to the switch's Web server.

Disabling the Web interface takes effect immediately. All interfaces are affected.

<b>Syntax</b>
<b>ip http server</b> <b>no ip http server</b>

**no** - This command disables access to the switch through the Web interface. When access is disabled, the user cannot login to the switch's Web server.

### Default Setting

Enabled

### Command Mode

Global Config

#### 6.3.6.5 ip http secure-port

This command is used to set the SSLT port where port can be 1-65535 and the default is port 443.

**Syntax**

```
ip http secure-port <portid>
no ip http secure-port
```

**<portid>** - SSLT Port value.

**no** - This command is used to reset the SSLT port to the default value.

**Default Setting**

443

**Command Mode**

Global Config

**6.3.6.6 ip http secure-server**

This command is used to enable the secure socket layer for secure HTTP.

**Syntax**

```
ip http secure-server
no ip http secure-server
```

**no** - This command is used to disable the secure socket layer for secure HTTP.

**Default Setting**

Disabled

**Command Mode**

Global Config

**6.3.6.7 ip http secure-protocol**

This command is used to set protocol levels (versions). The protocol level can be set to TLS1, SSL3 or to both TLS1 and SSL3.

**Syntax**

```
ip http secure-protocol <protocollevel1> [protocollevel2]
no ip http secure-protocol <protocollevel1> [protocollevel2]
```

**<protocollevel1 - 2>** - The protocol level can be set to TLS1, SSL3 or to both TLS1 and SSL3.

**no** - This command is used to remove protocol levels (versions) for secure HTTP.

**Default Setting**

SSL3 and TLS1

**Command Mode**

Global Config

### 6.3.7 Secure Shell (SSH) Commands

#### 6.3.7.1 show ip ssh

This command displays the SSH settings.

**Syntax**

```
show ip ssh
```

**Default Setting**

None

**Command Mode**

Privileged Exec

**Display Message**

**Administrative Mode:** This field indicates whether the administrative mode of SSH is enabled or disabled.

**Protocol Levels:** The protocol level may have the values of version 1, version 2, or both versions.

**SSH Sessions Currently Active:** This field specifies the current number of SSH connections.

**Max SSH Sessions Allowed:** The maximum number of inbound SSH sessions allowed on the switch.

**SSH Timeout:** This field is the inactive timeout value for incoming SSH sessions to the switch.

### 6.3.7.2 ip ssh

This command is used to enable SSH.

<b>Syntax</b>
---------------

<pre>ip ssh no ip ssh</pre>
-----------------------------

**no** - This command is used to disable SSH.

#### Default Setting

Disabled

#### Command Mode

Global Config

### 6.3.7.3 ip ssh protocol

This command is used to set or remove protocol levels (or versions) for SSH. Either SSH1 (1), SSH2 (2), or both SSH 1 and SSH 2 (1 and 2) can be set.

<b>Syntax</b>
---------------

<pre>ip ssh protocol &lt;protocollevel1&gt; [protocollevel2]</pre>
--

**<protocollevel1 - 2>** - The protocol level can be set to SSH1, SSH2 or to both SSH 1 and SSH 2.

#### Default Setting

SSH1 and SSH2

#### Command Mode



Global Config

#### 6.3.7.4 ip ssh maxsessions

This command specifies the maximum number of SSH connection sessions that can be established. A value of 0 indicates that no ssh connection can be established. The range is 0 to 5.

**Syntax**

```
ip ssh maxsessions <0-5>  
no ip ssh maxsessions
```

**<0-5>** - maximum number of sessions.

**no** - This command sets the maximum number of SSH connection sessions that can be established to the default value.

**Default Setting**

SSH1 and SSH2

**Command Mode**

Global Config

#### 6.3.7.5 ip ssh timeout

This command sets the SSH connection session timeout value, in minutes. A session is active as long as the session has been idle for the value set. A value of 0 indicates that a session remains active indefinitely. The time is a decimal value from 0 to 160. Changing the timeout value for active sessions does not become effective until the session is reaccessed. Any keystroke will also activate the new timeout duration.

**Syntax**

```
ip ssh timeout <1-160>
```

```
no ip ssh timeout
```

<1-160> - timeout interval in seconds.

**no** - This command sets the SSH connection session timeout value, in minutes, to the default. Changing the timeout value for active sessions does not become effective until the session is reaccessed. Any keystroke will also activate the new timeout duration.

#### Default Setting

5

#### Command Mode

Global Config

#### 6.3.7.6 http session hard-timeout

This command configures the hard timeout for secure HTTP sessions in hours. Configuring this value to zero will give an infinite hard-timeout. When this timeout expires, the user will be forced to re-authenticate. This timer begins on initiation of the web session and is unaffected by the activity level of the connection. Use the **ip http session hard-timeout<0-168>** command to configure the switch, command **no ip http session hard-timeout** will return to default value, default value is 24.

#### Syntax

```
ip http session hard-timeout<hard-timeout>  
no ip http session hard-timeout
```

#### Default Setting

24

#### Command Mode

Global Config

#### 6.3.7.7 http session hard-timeout

This command configures the hard timeout for secure HTTP sessions in hours. When this timeout expires, the user is forced to re-authenticate. This timer begins on initiation of the Web session and is unaffected by the activity level of the connection. The secure-session hard-timeout can not be set to zero (infinite). Use the **ip http secure-session hard-timeout<1-168>** command to configure the switch, command **no ip http**

**secure-session hard-timeout** will return to default value, default value is 24.

**Syntax**

```
ip http secure-session hard-timeout<hard-timeout>  
no ip http secure-session hard-timeout
```

**Default Setting**

24

**Command Mode**

Global Config

**6.3.7.8 http session soft-timeout**

This command configures the soft timeout for un-secure HTTP sessions in minutes. Configuring this value to zero will give an infinite soft-timeout. When this timeout expires the user will be forced to re-authenticate. This timer begins on initiation of the Web session and is re-started with each access to the switch. User the **ip http session soft-timeout<0-60>** command to configure the switch, command **no ip http session soft-timeout** will return to default value, default value is 5.

**Syntax**

```
ip http session soft-timeout<soft-timeout>  
no ip http session soft-timeout
```

**Default Setting**

5

**Command Mode**

Global Config

**6.3.7.9 http secure-session soft-timeout**

This command configures the soft timeout for secure HTTP sessions in minutes. Configuring this value to zero will give an infinite soft-timeout. When this timeout expires, you are forced to re-authenticate. This timer begins on initiation of the Web session and is re-started with each access to the switch. The secure-session soft-timeout can not be set to zero (infinite). User the **ip http secure-session soft-timeout<1-60>** command to configure the switch, command **no ip http secure-session soft-timeout** will return to default value, default value is 5.

**Syntax**

```
ip http secure-session soft-timeout<soft-timeout>  
no ip http secure-session soft -timeout
```

**Default Setting**

5

**Command Mode**

Global Config

**6.3.7.10 Set max sessions**

This command limits the number of allowable un-secure HTTP sessions. Zero is the configurable minimum. Use the **ip http session maxsessions <0-16>** command to configure the switch, command **no ip http session maxsessions** will return to default value, default value is 16.

**Syntax**

```
ip http session maxsessions<maxsessions>  
no ip http session maxsessions
```

**Default Setting**

16

**Command Mode**

Global Config

**6.3.7.11 Set max secure-sessions**

This command limits the number of secure HTTP sessions. Zero is the configurable minimum. Use the **ip http secure-session maxsessions <0-16>** command to configure the switch, command **no ip http secure-session maxsessions** will return to default value, default value is 16.

**Syntax**

```
ip http secure-session maxsessions<maxsessions>  
no ip http secure-session maxsessions
```

**Default Setting**

16

**Command Mode**

Global Config

**6.3.7.12 Set ip http java**

Web Java mode. The Java mode applies to both secure and un-secure Web connections.

**Syntax**

```
ip http java
no ip http java
```

**Default Setting**

Enable

**Command Mode**

Global Config

**6.3.8 DHCP Client Commands****6.3.8.1 ip dhcp restart**

This command is used to initiate a BOOTP or DCHP client request.

**Syntax**

```
ip dhcp restart
```

**Default Setting**

None

**Command Mode**

Global Config

### 6.3.8.2 ip dhcp client-identifier

This command is used to specify the DHCP client identifier for this switch. Use the **no** form to restore to default value.

#### Syntax

```
ip dhcp client-identifier {text <text> | hex <hex>}  
no ip dhcp client-identifier
```

**<text>** - A text string. (Range: 1-15 characters).

**<hex>** - The hexadecimal value (00:00:00:00:00:00).

**no** - This command is used to restore to default value.

#### Default Setting

System Burned In MAC Address

#### Command Mode

Global Config

## 6.3.9 DHCP Relay Commands

### 6.3.9.1 show bootpdhcrelay

This command is used to display the DHCP relay agent configuration information on the system.

#### Syntax

```
show bootpdhcrelay
```

#### Default Setting

None

**Command Mode**

Privileged Exec

**Display Message**

**Maximum Hop Count** - The maximum number of Hops a client request can go without being discarded.

**Minimum Wait Time (Seconds)** - The Minimum time in seconds. This value will be compared to the time stamp in the client's request packets, which should represent the time since the client was powered up. Packets will only be forwarded when the time stamp exceeds the minimum wait time.

**Admin Mode** - Administrative mode of the relay. When you select 'enable' BOOTP/DHCP requests will be forwarded to the IP address you entered in the 'Server IP address' field.

**Server IP Address** - IP address of the BOOTP/DHCP server or the IP address of the next BOOTP/DHCP Relay Agent.

**Circuit Id Option Mode** - This is the Relay agent option which can be either enabled or disabled. When enabled Relay Agent options will be added to requests before they are forwarded to the server and removed from replies before they are forwarded to clients.

**Requests Received** - The total number of BOOTP/DHCP requests received from all clients since the last time the switch was reset.

**Requests Relayed** - The total number of BOOTP/DHCP requests forwarded to the server since the last time the switch was reset.

**Packets Discarded** - The total number of BOOTP/DHCP packets discarded by this Relay Agent since the last time the switch was reset.

**6.3.9.2 bootpdhcprelay maxhopcount**

This command is used to set the maximum relay agent hops for BootP/DHCP Relay on the system.

**Syntax**

```
bootpdhcprelay maxhopcount <1-16>  
no bootpdhcprelay maxhopcount
```

**<1-16>** - maximum number of hops. (Range: 1-16).

**no** - This command is used to reset to the default value.

**Default Setting**

4

**Command Mode**

Global Config

**6.3.9.3 bootpdhcprelay serverip**

This command is used to configure the server IP Address for BootP/DHCP Relay on the system.

**Syntax**

```
bootpdhcprelay serverip <ipaddr>  
no bootpdhcprelay serverip
```

**<ipaddr>** - A server IP address.

**no** - This command is used to reset to the default value.

**Default Setting**

IP 0.0.0.0

**Command Mode**

Global Config

**6.3.10 sFlow Commands****6.3.10.1 show sFlow information**

The user can go to the CLI Privilege Mode to get all of sFlow information, use the **show sflow** Privilege command.

**Syntax**

```
show sflow
```



**Default Setting**

None

**Command Mode**Privilege Mode  
User Mode**Display Message****Intf:** Interface number.**Collector-Address:** Display sFlow collector IP address.**Collector-Port:** Display sFlow collector-port. Allowed range is (1025 to 65535). Default value is 6343.**Rate:** If the throughput larger than sFlow rate, the agent(client) will trigger an flow sample event and send a flow sample packet to collector(server). Allowed range is (1000 to 100000000). Default value is 0. 0 means no sFlow rate.**Interval:** It is a period timer, the agent will send counter sample packet to collector when timeup. Allowed range is (20 to 120). Default value is 0. 0 means no sFlow interval.**Header Size:** Flow sample content a packet which capture by BCM chip, and maximum header-size means the size we reference. If BCM chip capture packet is 64 bytes, but the maximum header-size is 36 bytes, then 36 bytes of this packet will be generate into the flow sample packet. Allowed range is (32 to 256). Default value is 128.**Datagram Size:** Like maximum header-size, maximum datagram-size is the maximum size of UDP content (doesn't include UDP header and above). Allowed range is (500 to 1470). Default value is 1400.**6.3.10.2 set sFlow sampling rate**

The user can go to the CLI Interface Configuration Mode to set sampling rate, use the **sflow rate <1-1310720>** interface configuration command. Use the **no sflow rate** return to default value zero.

**Syntax**

```
sflow rate <1000-10000000/100000000>  
no sflow rate
```

**Default Setting**

0

**Command Mode**

Interface Configure

### 6.3.10.3 set sFlow maximum header size

The user can go to the CLI Interface Configuration Mode to set maximum header size, use the **sflow maximum-header <32-256>** interface configuration command. Use the **no sflow maximum-header** return to default value 128

**Syntax**

```
sflow maximum-header <32-256>  
no sflow maximum-header
```

**Default Setting**

128

**Command Mode**

Interface Configure

### 6.3.10.4 set sFlow maximum datagram size

The user can go to the CLI Interface Configuration Mode to set maximum datagram size, use the **sflow maximum-datagram <500-1470>** interface configuration command. Use the **no sflow maximum-datagram** return to default value 1400.

**Syntax**

```
sflow maximum-datagram <500-1470>  
no sflow maximum-datagram
```

**Default Setting**

1400

**Command Mode**

Interface Configure

### 6.3.10.5 set sFlow collector address

The user can go to the CLI Interface Configuration Mode to set collector ip address, use the **sflow collector-address <ip-address>** interface configuration command. Use the **no sflow collector-address** to clear collector ip address.

**Syntax**

```
sflow collector-address <ip-address>  
no sflow collector-address
```

**Default Setting**

none

**Command Mode**

Interface Configure

**6.3.10.6 set sFlow collector port**

The user can go to the CLI Interface Configuration Mode to set collector UDP port, use the **sflow collector-port <1025-65535>** interface configuration command. Use the **no sflow collector-port** return to default UDP port 6343.

**Syntax**

```
sflow collector- port <1025-65535>  
no sflow collector-port
```

**Default Setting**

6343

**Command Mode**

Interface Configure

**6.3.10.7 set sFlow interval**

The user can go to the CLI Interface Configuration Mode to set sampling interval, use the **sflow interval <20-120>** interface configuration command. Use the **no sflow interval** return to default value zero.

**Syntax**

```
sflow interval <20-120>  
no sflow interval
```

**Default Setting**

0

**Command Mode**

Interface Configure

**6.3.11 Service Port Commands****6.3.11.1 show serviceport**

This command displays service port configuration information.

**Syntax**

```
show serviceport
```

**Default Setting**

None

**Command Mode**

Privileged Exec

**Display Message**

**IP Address:** The IP address of the interface. The factory default value is 0.0.0.0.

**Subnet Mask:** The IP subnet mask for this interface. The factory default value is 0.0.0.0.

**Default Gateway:** The default gateway for this IP interface. The factory default value is 0.0.0.0.

**ServPort Configured Protocol Current:** Indicates what network protocol was used on the last, or current power-up cycle, if any.

**Burned In MAC Address:** The burned in MAC address used for in-band connectivity.

**6.3.11.2 show serviceport ndp**

This command displays IPv6 Neighbor entries.

**Syntax**

```
show serviceport ndp
```

**Default Setting**

None

**Command Mode**

Privileged Exec

**Display Message**

**IPv6 Address:** Specifies the IPv6 address of neighbor or interface.

**MAC Address:** Specifies MAC address associated with an interface.

**isRr:.** Specifies router flag.

**Neighbor State:**

**Incmp** - Address resolution is being performed on the entry. A neighbor solicitation message has been sent to the solicited-node multicast address of the target, but the corresponding neighbor advertisement message has not yet been received.

**Reach** - Positive confirmation was received within the last Reachable Time milliseconds that the forward path to the neighbor was functioning properly. While in REACH state, the device takes no special action as packets are sent.

**Stale** - More than ReachableTime milliseconds have elapsed since the last positive confirmation was received that the forward path was functioning properly. While in STALE state, the device takes no action until a packet is sent.

**Delay** - More than ReachableTime milliseconds have elapsed since the last positive confirmation was received that the forward path was functioning properly. A packet was sent within the last DELAY\_FIRST\_PROBE\_TIME seconds. If no reachability confirmation is received within DELAY\_FIRST\_PROBE\_TIME seconds of entering the DELAY state, send a neighbor solicitation message and change the state to PROBE.

**Probe** - A reachability confirmation is actively sought by resending neighbor solicitation messages every RetransTimer milliseconds until a reachability confirmation is received.

**Last Updated:** Time since the address was confirmed to be reachable.

**6.3.11.3 serviceport ip**

This command sets the IP address, the netmask and the gateway of the network management port.

**Syntax**

```
serviceport ip <ipaddr> <netmask> [gateway]
```

**<ipaddr>** - The user manually configures IP address for this switch.

**<netmask>** - The user manually configures Subnet Mask for this switch.

**gateway** - The user manually configures gateway server for this switch.

**Default Setting**

None

**Command Mode**

Privileged Exec

**6.3.11.4 serviceport protocol**

This command specifies the network management port configuration protocol. If you modify this value, the change is effective immediately. If you use the bootp parameter, the switch periodically sends requests to a BootP server until a response is received. If you use the dhcp parameter, the switch periodically sends requests to a DHCP server until a response is received. If you use the none parameter, you must configure the network information for the switch manually.

**Syntax**

```
serviceport protocol {none | bootp | dhcp}
```

**none** - Configure the network information for the switch manually.

**bootp** - Periodically sends requests to a BootP server until a response is received.

**dhcp** - Periodically sends requests to a DHCP server until a response is received.

**Default Setting**

None

**Command Mode**

Privileged Exec

## 6.4 Spanning Tree Commands

This section provides detailed explanation of the spanning tree commands. The commands are divided into two functional groups:

- Show commands display spanning tree settings, statistics, and other information.
- Configuration Commands configure features and options of the switch. For every configuration command there is a show command that displays the configuration setting.

### 6.4.1 Show Commands

#### 6.4.1.1 show spanning-tree

This command displays spanning tree settings for the common and internal spanning tree. The following details are displayed.

<b>Syntax</b>
---------------

<code>show spanning-tree</code>
---------------------------------

#### Default Setting

None

#### Command Mode

Privileged Exec

#### Display Message

**Bridge Priority:** Configured value.

**Bridge Identifier:** The MAC Address for the Bridge from which the Bridge Identifiers used by the Spanning Tree Algorithm and Protocol.

**Time Since Topology Change:** In seconds.

**Topology Change Count:** Number of times changed.

**Topology Change in progress:** Boolean value of the Topology Change parameter for the switch indicating if a topology change is in progress on any port assigned to the common and internal spanning tree.

**Designated Root:** The Bridge Identifier of the Root Bridge for the spanning tree instance identified by the MSTID.

**Root Path Cost:** Value of the Root Path Cost parameter for the common and internal spanning tree.

**Root Port Identifier:** The Root Port for the spanning tree instance identified by the MSTID.

**Bridge Max Age:** Maximum message age.

**Bridge Max Hops:** The maximum number of hops for the spanning tree.

**Bridge Forwarding Delay:** A timeout value to be used by all Bridges in the Bridged LAN. The value of Forward Delay is set by the Root.

**Hello Time:** The time interval between the generations of Configuration BPDUs.

**Bridge Hold Time:** Minimum time between transmissions of Configuration Bridge Protocol Data Units (BPDUs).

**CST Regional Root:** The Bridge Identifier of the current CST Regional Root.

**Regional Root Path Cost:** The path cost to the regional root.

**Associated FIDs:** List of forwarding database identifiers currently associated with this instance.

**Associated VLANs:** List of VLAN IDs currently associated with this instance.

#### 6.4.1.2 show spanning-tree interface

This command displays the settings and parameters for a specific switch port within the common and internal spanning tree. The <slot/port> is the desired switch port. The following details are displayed on execution of the command.

<b>Syntax</b>
---------------

<b>show spanning-tree interface &lt;slot/port&gt;</b>
---

<slot/port> - is the desired interface number.

#### Default Setting

None

#### Command Mode

Privileged Exec

#### Display Message

**Port Mode:** The administration mode of spanning tree.

**Port Up Time Since Counters Last Cleared:** Time since the port was reset, displayed in days, hours, minutes, and seconds.

**STP BPDUs Transmitted:** Spanning Tree Protocol Bridge Protocol Data Units sent.

**STP BPDUs Received:** Spanning Tree Protocol Bridge Protocol Data Units received.

**RST BPDUs Transmitted:** Rapid Spanning Tree Protocol Bridge Protocol Data Units sent.

**RST BPDUs Received:** Rapid Spanning Tree Protocol Bridge Protocol Data Units received.

**MSTP BPDUs Transmitted:** Multiple Spanning Tree Protocol Bridge Protocol Data Units sent.

**MSTP BPDUs Received:** Multiple Spanning Tree Protocol Bridge Protocol Data Units received.



### 6.4.1.3 show spanning-tree vlan

This command displays the association between a VLAN and a multiple spanning tree instance. The <1-3965> corresponds to an existing VLAN ID.

**Syntax**

```
show spanning-tree vlan <1-3965>
```

<vlanid> - VLAN ID (Range: 1 - 3965).

**Default Setting**

None

**Command Mode**

Privileged Exec

**Display Message**

**VLAN Identifier:** displays VLAN ID.

**Associated Instance:** Identifier for the associated multiple spanning tree instance or "CST" if associated with the common and internal spanning tree.

### 6.4.1.4 show spanning-tree mst

This command displays settings and parameters for the specified multiple spanning tree instance. The instance <0-4094> is a number that corresponds to the desired existing multiple spanning tree instance ID. The following details are displayed.

**Syntax**

```
show spanning-tree mst detailed <0-4094>
```

<0-4094> - multiple spanning tree instance ID.

**Default Setting**

None

**Command Mode**

Privileged Exec

**Display Message****MST Instance ID:** The multiple spanning tree instance ID.**MST Bridge Priority:** The bridge priority of current MST.**MST Bridge Identifier:** The bridge ID of current MST.**Time Since Topology Change:** In seconds.**Topology Change Count:** Number of times the topology has changed for this multiple spanning tree instance.**Topology Change in Progress:** Value of the Topology Change parameter for the multiple spanning tree instance.**Designated Root:** Identifier of the Regional Root for this multiple spanning tree instance.**Root Path Cost:** Path Cost to the Designated Root for this multiple spanning tree instance.**Root Port Identifier:** Port to access the Designated Root for this multiple spanning tree instance**Associated FIDs:** List of forwarding database identifiers associated with this instance.**Associated VLANs:** List of VLAN IDs associated with this instance.

This command displays summary information about all multiple spanning tree instances in the switch. On execution, the following details are displayed.

**Syntax**

```
show spanning-tree mst summary
```

**Default Setting**

None

**Command Mode**

Privileged Exec

**Display Message****MST Instance ID List:** List of multiple spanning trees IDs currently configured.**For each MSTID:** The multiple spanning tree instance ID.**Associated FIDs:** List of forwarding database identifiers associated with this instance.**Associated VLANs:** List of VLAN IDs associated with this instance.

This command displays the detailed settings and parameters for a specific switch port within a particular multiple spanning tree instance. The instance <mstid> is a number that corresponds to the desired existing multiple spanning tree instance. The <slot/port> is the desired switch port.

**Syntax**

```
show spanning-tree mst port detailed <0-4094> <slot/port>
```

<0-4094> - multiple spanning tree instance ID.

<slot/port> - is the desired interface number.

**Default Setting**

None

**Command Mode**

Privileged Exec

**Display Message**

**MST Instance ID:** The multiple spanning tree instance ID.

**Port Identifier:** The unique value to identify a port on that Bridge.

**Port Priority:** The priority of the port within the MST.

**Port Forwarding State:** Current spanning tree state of this port.

**Port Role:** Indicate the port role is root or designate.

**Auto-calculate Port Path Cost:** Indicate the port auto-calculate port path cost.

**Port Path Cost:** Configured value of the Internal Port Path Cost parameter.

**Designated Root:** The Identifier of the designated root for this port.

**Designated Port Cost:** Path Cost offered to the LAN by the Designated Port.

**Designated Bridge:** Bridge Identifier of the bridge with the Designated Port.

**Designated Port Identifier:** Port on the Designated Bridge that offers the lowest cost to the LAN.

If 0 (defined as the default CIST ID) is passed as the <0-4094>, then this command displays the settings and parameters for a specific switch port within the common and internal spanning tree. The <slot/port> is the desired switch port. In this case, the following are displayed.

**Port Identifier:** The port identifier for this port within the CST.

**Port Priority:** The priority of the port within the CST.

**Port Forwarding State:** The forwarding state of the port within the CST.

**Port Role:** The role of the specified interface within the CST.

**Auto-calculate Port Path Cost:** Indicate the port auto-calculate port path cost

**Auto-calculate External Port Path Cost** - Displays whether the external path cost is automatically calculated (Enabled) or not (Disabled). External Path cost will be calculated based on the link speed of the port if the configured value for External Port Path Cost is zero.

**External Port Path Cost** - The External Path Cost of the specified port in the spanning tree.

**Port Path Cost:** The configured path cost for the specified interface.

**Designated Root:** Identifier of the designated root for this port within the CST.

**Designated Port Cost:** Path Cost offered to the LAN by the Designated Port.

**Designated Bridge:** The bridge containing the designated port.

**Designated Port Identifier:** Port on the Designated Bridge that offers the lowest cost to the LAN.

**Topology Change Acknowledgement:** Value of flag in next Configuration Bridge Protocol Data Unit (BPDU) transmission indicating if a topology change is in progress for this port.

**Hello Time:** The hello time in use for this port.

**Edge Port:** The configured value indicating if this port is an edge port.

**Edge Port Status:** The derived value of the edge port status. True if operating as an edge port; false otherwise.

**Point To Point MAC Status:** Derived value indicating if this port is part of a point to point link.

**CST Regional Root:** The regional root identifier in use for this port.

**CST Port Cost:** The configured path cost for this port.

This command displays the settings of one or all ports within the specified multiple spanning tree instance. The parameter <0-4094> indicates a particular MST instance. The parameter {<slot/port> | all} indicates the desired switch port or all ports.

If 0 (defined as the default CIST ID) is passed as the <0-4094>, then the status summary is displayed for one or all ports within the common and internal spanning tree.

#### Syntax

```
show spanning-tree mst port summary <0-4094> {<slot/port> | all}
```

**<0-4094>** - multiple spanning tree instance ID.

**<slot/port>** - is the desired interface number.

**all** - All interfaces.

#### Default Setting

None

#### Command Mode

Privileged Exec

#### Display Message

**MST Instance ID:** The MST instance associated with this port.

**Interface:** The interface being displayed.

**STP Mode:** Indicate STP mode.

**Type:** Currently not used.

**STP State:** The forwarding state of the port in the specified spanning tree instance.

**Port Role:** The role of the specified port within the spanning tree.

#### 6.4.1.5 show spanning-tree summary

This command displays spanning tree settings and parameters for the switch. The following details are displayed on execution of the command.

<b>Syntax</b>
---------------

<code>show spanning-tree summary</code>
---

#### Default Setting

None

#### Command Mode

Privileged Exec

#### Display Message

**Spanning Tree Adminmode:** Enabled or disabled.

**Spanning Tree Version:** Version of 802.1 currently supported (IEEE 802.1s, IEEE 802.1w, or IEEE 802.1d) based upon the Force Protocol Version parameter.

**Configuration Name:** TConfigured name.

**Configuration Revision Level:** Configured value.

**Configuration Digest Key:** Calculated value.

**Configuration Format Selector:** Configured value.

**MST Instances:** List of all multiple spanning tree instances configured on the switch.

#### 6.4.1.6 show spanning-tree brief

This command displays spanning tree settings for the bridge. In this case, the following details are displayed.

<b>Syntax</b>
---------------

<code>show spanning-tree brief</code>
---------------------------------------

#### Default Setting

None

**Command Mode**

Privileged Exec

**Display Message**

**Bridge Priority:** Configured value.

**Bridge Identifier:** The bridge ID of current Spanning Tree.

**Bridge Max Age:** Configured value.

**Bridge Hello Time:** Configured value.

**Bridge Forward Delay:** Configured value.

**Bridge Hold Time:** Minimum time between transmission of Configuration Bridge Protocol Data Units (BPDUs).

## 6.4.2 Configuration Commands

### 6.4.2.1 spanning-tree

This command sets the spanning-tree operational mode to be enabled.

<b>Syntax</b>
<b>spanning-tree</b> <b>no spanning-tree</b>

**no** - This command sets the spanning-tree operational mode to be disabled. While disabled, the spanning-tree configuration is retained and can be changed, but is not activated.

**Default Setting**

Disabled

**Command Mode**

Global Config

### 6.4.2.2 spanning-tree protocol-migration

This command enables BPDU migration check on a given interface. The **all** option enables BPDU migration check on all interfaces.

**Syntax**

```
spanning-tree protocol-migration {<slot/port> | all}
no spanning-tree protocol-migration {<slot/port> | all}
```

**<slot/port>** - is the desired interface number.

**all** - All interfaces.

**no** - This command disables BPDU migration check on a given interface. The **all** option disables BPDU migration check on all interfaces.

**Default Setting**

None

**Command Mode**

Global Config

**6.4.2.3 spanning-tree configuration**

This command sets the Configuration Identifier Name for use in identifying the configuration that this switch is currently using. The <name> is a string of at most 32 alphanumeric characters.

**Syntax**

```
spanning-tree configuration name <name>
no spanning-tree configuration name
```

**<name>** - is a string of at most 32 alphanumeric characters.

**no** - This command resets the Configuration Identifier Name to its default.

**Default Setting**

The base MAC address displayed using hexadecimal notation as specified in IEEE 802 standard.

**Command Mode**

## Global Config

This command sets the Configuration Identifier Revision Level for use in identifying the configuration that this switch is currently using. The Configuration Identifier Revision Level is a number in the range of 0 to 65535.

**Syntax**

```
spanning-tree configuration revision <0-65535>  
no spanning-tree configuration revision
```

**<value>** - Revision Level is a number in the range of 0 to 65535.

**no** - This command sets the Configuration Identifier Revision Level for use in identifying the configuration that this switch is currently using to the default value, that is, 0.

**Default Setting**

0

**Command Mode**

Global Config

**6.4.2.4 spanning-tree mode**

This command sets the Force Protocol Version parameter to a new value. The Force Protocol Version can be one of the following:

1. stp - ST BPDUs are transmitted rather than MST BPDUs (IEEE 802.1d functionality supported)
2. rstp - RST BPDUs are transmitted rather than MST BPDUs (IEEE 802.1w functionality supported)
3. mstp - MST BPDUs are transmitted (IEEE 802.1s functionality supported)

**Syntax**

```
spanning-tree mode {stp | rstp | mstp}  
no spanning-tree mode
```



**no** - This command sets the Force Protocol Version parameter to the default value, that is, mstp.

**Default Setting**

mstp

**Command Mode**

Global Config

**6.4.2.5 spanning-tree forward-time**

This command sets the Bridge Forward Delay parameter to a new value for the common and internal spanning tree. The forward-time value is in seconds within a range of 4 to 30, with the value being greater than or equal to "(Bridge Max Age / 2) + 1".

**Syntax****spanning-tree forward-time <4-30>****no spanning-tree forward-time**

**<4-30>** - forward time value (Range: 4 – 30).

**no** - This command sets the Bridge Forward Delay parameter for the common and internal spanning tree to the default value, that is, 15.

**Default Setting**

15

**Command Mode**

Global Config

**6.4.2.6 spanning-tree hello-time**

This command sets the Hello Time parameter to a new value for the common and internal spanning tree. The hellotime value is in whole seconds within a range of 1 to 10 with the value being less than or equal to "(Bridge Max Age / 2) - 1".

**Syntax**

```
spanning-tree hello-time <1-10>  
no spanning-tree hello-time
```

<1-10> - hellotime value (Range: 1 – 10).

**no** - This command sets the Hello Time parameter for the common and internal spanning tree to the default value, that is, 2.

**Default Setting**

2

**Command Mode**

Global Config

**6.4.2.7 spanning-tree max-age**

This command sets the Bridge Max Age parameter to a new value for the common and internal spanning tree. The max-age value is in seconds within a range of 6 to 40, with the value being less than or equal to "2 times (Bridge Forward Delay - 1)" and greater than or equal to "2 times (Bridge Hello Time + 1)".

**Syntax**

```
spanning-tree max-age <6-40>  
no spanning-tree max-age
```

<6-40> - the Bridge Max Age value (Range: 6 – 40).

**no** - This command sets the Bridge Max Age parameter for the common and internal spanning tree to the default value, that is, 20.

**Default Setting**

20

**Command Mode**

Global Config

#### 6.4.2.8 spanning-tree max-hops

This command sets the MSTP Max Hops parameter to a new value for the common and internal spanning tree. The max-hops value is in a range of 1 to 127.

##### Syntax

```
spanning-tree max-hops <1-127>  
no spanning-tree max-hops
```

<1-127> - the Maximum hops value (Range: 1-127).

**no** - This command sets the Bridge Max Hops parameter for the common and internal spanning tree to the default value.

#### Default Setting

20

#### Command Mode

Global Config

#### 6.4.2.9 spanning-tree mst

This command adds a multiple spanning tree instance to the switch. The instance <1-3965> is a number within a range of 1 to 3965 that corresponds to the new instance ID to be added. The maximum number of multiple instances supported is 4.

##### Syntax

```
spanning-tree mst instance <1-4094>  
no spanning-tree mst instance <1-4094>
```

<1-4094> - multiple spanning tree instance ID.

**no** - This command removes a multiple spanning tree instance from the switch and

reallocates all VLANs allocated to the deleted instance to the common and internal spanning tree. The instance <1-4094> is a number that corresponds to the desired existing multiple spanning tree instance to be removed.

**Default Setting**

None

**Command Mode**

Global Config

This command sets the bridge priority for a specific multiple spanning tree instance. The instance <mstid> is a number that corresponds to the desired existing multiple spanning tree instance. The priority value is a number within a range of 0 to 61440 in increments of 4096.

If 0 (defined as the default CIST ID) is passed as the <mstid>, then this command sets the Bridge Priority parameter to a new value for the common and internal spanning tree. The bridge priority value again is a number within a range of 0 to 61440. The twelve least significant bits will be masked according to the 802.1s specification.

This will cause the priority to be rounded down to the next lower valid priority.

**Syntax**

```
spanning-tree mst priority <0-4094> <0-61440>  
no spanning-tree mst priority <0-4094>
```

<0-4094> - multiple spanning tree instance ID.

<0-61440> - priority value (Range: 0 – 61440).

**no** - This command sets the bridge priority for a specific multiple spanning tree instance to the default value, that is, 32768. The instance <0-4094> is a number that corresponds to the desired existing multiple spanning tree instance.

If 0 (defined as the default CIST ID) is passed as the <0-4094>, then this command sets the Bridge Priority parameter for the common and internal spanning tree to the default value, that is, 32768.

**Default Setting**

32768

**Command Mode**

Global Config

This command adds an association between a multiple spanning tree instance and a VLAN. The VLAN will no longer be associated with the common and internal spanning tree. The instance <0-4094> is a number that corresponds to the desired existing multiple spanning tree instance. The <1-3965> corresponds to an existing VLAN ID.

**Syntax**

```
spanning-tree mst vlan <0-4094> <1-3965>  
no spanning-tree mst vlan <0-4094> <1-3965>
```

<0-4094> - multiple spanning tree instance ID.

<1-3965> - VLAN ID (Range: 1 – 3965).

**no** - This command removes an association between a multiple spanning tree instance and a VLAN. The VLAN will again be associated with the common and internal spanning tree. The instance <0-4094> is a number that corresponds to the desired existing multiple spanning tree instance. The <1-3965> corresponds to an existing VLAN ID.

**Default Setting**

None

**Command Mode**

Global Config

This command sets the Path Cost or Port Priority for this port within the multiple spanning tree instance or in the common and internal spanning tree. If the <0-4094> parameter corresponds to an existing multiple spanning tree instance, then the configurations are done for that multiple spanning tree instance. If however 0 (defined as the default CIST ID) is passed as the <0-4094>, then the configurations are performed for the common and internal spanning tree instance.

If the 'cost' token is specified, this command sets the path cost for this port within a multiple spanning tree instance or the common and internal spanning tree instance, depending on the <0-4094> parameter. The pathcost can be specified as a number in the range of 1 to 200000000 or auto. If "auto" is specified, the pathcost value will be set based on Link Speed.

**Syntax**

```
spanning-tree mst <0-4094> cost {<1-200000000> | auto}  
no spanning-tree mst <0-4094> cost
```

**<0-4094>** - multiple spanning tree instance ID.

**no** - This command sets the Path Cost or Port Priority for this port within the multiple spanning tree instance or in the common and internal spanning tree to the respective default values. If the <0-4094> parameter corresponds to an existing multiple spanning tree instance, then the configurations are done for that multiple spanning tree instance. If however, 0 (defined as the default CIST ID) is passed as the <0-4094>, then the configurations are performed for the common and internal spanning tree instance.

If the 'cost' token is specified, this command sets the path cost for this port within a multiple spanning tree instance or the common and internal spanning tree instance, depending on the <0-4094> parameter, to the default value, that is, a pathcost value based on the Link Speed.

**Default Setting**

Cost : auto

**Command Mode**

Interface Config

This command sets the Path Cost or Port Priority for this port within the multiple spanning tree instance or in the common and internal spanning tree. If the <0-4094> parameter corresponds to an existing multiple spanning tree instance, then the configurations are done for that multiple spanning tree instance. If however 0 (defined as the default CIST ID) is passed as the <0-4094>, then the configurations are performed for the common and internal spanning tree instance.

If the 'port-priority' token is specified, this command sets the priority for this port within a specific multiple spanning tree instance or the common and internal spanning tree instance, depending on the <0-4094> parameter. The port-priority value is a number in the range of 0 to 240 in increments of 16.

**Syntax**

```
spanning-tree mst <0-4094> port-priority <0-240>
```

**no spanning-tree mst <0-4094> port-priority**

**<0-4094>** - multiple spanning tree instance ID.

**no** - This command sets the Path Cost or Port Priority for this port within the multiple spanning tree instance or in the common and internal spanning tree to the respective default values. If the <0-4094> parameter corresponds to an existing multiple spanning tree instance, then the configurations are done for that multiple spanning tree instance. If however, 0 (defined as the default CIST ID) is passed as the <0-4094>, then the configurations are performed for the common and internal spanning tree instance.

If the 'port-priority' token is specified, this command sets the priority for this port within a specific multiple spanning tree instance or the common and internal spanning tree instance, depending on the <0-4094> parameter, to the default value, that is, 128.

#### Default Setting

port-priority : 128

#### Command Mode

Interface Config

#### 6.4.2.10 spanning-tree port mode

This command sets the Administrative Switch Port State for this port to enabled.

#### Syntax

**spanning-tree port mode**  
**no spanning-tree port mode**

**no** - This command sets the Administrative Switch Port State for this port to disabled.

#### Default Setting

Disabled

#### Command Mode

Interface Config

This command sets the Administrative Switch Port State for all ports to enabled.

**Syntax**

```
spanning-tree port mode all
no spanning-tree port mode all
```

**all** - All interfaces.

**no** - This command sets the Administrative Switch Port State for all ports to disabled.

**Default Setting**

Disabled

**Command Mode**

Global Config

**6.4.2.11 spanning-tree edgeport**

This command specifies that this port is an Edge Port within the common and internal spanning tree. This will allow this port to transition to Forwarding State without delay.

**Syntax**

```
spanning-tree edgeport
no spanning-tree edgeport
```

**no** - This command specifies that this port is not an Edge Port within the common and internal spanning tree.

**Default Setting**

None

**Command Mode**

Interface Config



## 6.5 System Log Management Commands

### 6.5.1 Show Commands

#### 6.5.1.1 show logging

This command displays logging.

<b>Syntax</b>
---------------

<code>show logging</code>
---------------------------

#### Default Setting

None

#### Command Mode

Privileged Exec

#### Display Message

**Logging Client Local Port** The port on the collector/relay to which syslog messages are sent

**CLI Command Logging** The mode for CLI command logging.

**Console Logging** The mode for console logging.

**Console Logging Severity Filter** The minimum severity to log to the console log. Messages with an equal or lower numerical severity are logged.

**Buffered Logging** The mode for buffered logging.

**Syslog Logging** The mode for logging to configured syslog hosts. If set to disable logging stops to all syslog hosts.

**Log Messages Received** The number of messages received by the log process. This includes messages that are dropped or ignored

**Log Messages Dropped** The number of messages that could not be processed.

**Log Messages Relayed** The number of messages that are relayed.

### 6.5.2 show logging buffered

This command displays the message log maintained by the switch. The message log contains system trace information.

<b>Syntax</b>
---------------

```
show logging buffered
```

**Default Setting**

None

**Command Mode**

Privileged Exec

**Display Message****Message:** The message that has been logged.**Note:** Message log information is not retained across a switch reset.

### 6.5.3 show logging traplog

This command displays the trap log maintained by the switch. The trap log contains a maximum of 256 entries that wrap.

**Syntax**

```
show logging traplogs
```

**Default Setting**

None

**Command Mode**

Privileged Exec

**Display Message****Number of Traps since last reset:** The number of traps that have occurred since the last reset of this device.**Trap Log Capacity:** The maximum number of traps that could be stored in the switch.**Log:** The sequence number of this trap.**System Up Time:** The relative time since the last reboot of the switch at which this trap occurred.**Trap:** The relevant information of this trap.**Note:** Trap log information is not retained across a switch reset.

### 6.5.3.1 show logging hosts

This command displays all configured logging hosts.

<b>Syntax</b>
---------------

<b>show logging hosts</b>
---------------------------

#### Default Setting

None

#### Command Mode

Privileged Exec

#### Display Message

**Index (used for deleting)**

**IP Address** IP Address of the configured server.

**Severity** The minimum severity to log to the specified address.

**Port** Server Port Number. This is the port on the local host from which syslog messages are sent.

**Status** The state of logging to configured syslog hosts. If the status is disable, no logging occurs.

## 6.5.4 Configuration Commands

### 6.5.4.1 logging buffered

This command enables logging to in-memory log where up to 128 logs are kept.

<b>Syntax</b>
---------------

<b>logging buffered</b> <b>no logging buffered</b>
---

**no** - This command disables logging to in-memory log.

#### Default Setting

None

**Command Mode**

Privileged Exec

This command enables wrapping of in-memory logging when full capacity reached. Otherwise when full capacity is reached, logging stops.

**Syntax**

```
logging buffered wrap  
no logging buffered wrap
```

**no** - This command disables wrapping of in-memory logging when full capacity reached.

**Default Setting**

None

**Command Mode**

Privileged Exec

**6.5.4.2 logging console**

This command enables logging to the console.

**Syntax**

```
logging console [<severitylevel> | <0-7>]  
no logging console
```

**[<severitylevel> | <0-7>]** - The value is specified as either an integer from 0 to 7 or symbolically through one of the following keywords: emergency (0), alert (1), critical (2), error (3), warning (4), notice (5), informational (6), debug (7).

**no** - This command disables logging to the console.

**Default Setting**

None

**Command Mode**

Privileged Exec

**6.5.4.3 logging host**

This command enables logging to a host where up to eight hosts can be configured.

**Syntax**

```
logging host <hostaddress> [ <port>] [[<severitylevel> | <0-7>]]
```

**<hostaddress>** - IP address of the log server.

**<port>** - Port number.

**[<severitylevel> | <0-7>]** - The value is specified as either an integer from 0 to 7 or symbolically through one of the following keywords: emergency (0), alert (1), critical (2), error (3), warning (4), notice (5), informational (6), debug (7).

**Default Setting**

None

**Command Mode**

Privileged Exec

This command disables logging to hosts.

**Syntax**

```
logging host remove <hostindex>
```

**< hostindex >** - Index of the log server.

**Default Setting**

None

**Command Mode**

Privileged Exec

This command reconfigures the IP address of the log server.

**Syntax**

```
logging host reconfigure <hostindex> <hostaddress>
```

< hostindex > - Index of the log server.

<hostaddress> - New IP address of the log server.

**Default Setting**

None

**Command Mode**

Privileged Exec

**6.5.4.4 logging syslog**

This command enables syslog logging.

**Syntax**

```
logging syslog  
no logging syslog
```

**no** - Disables syslog logging.

**Default Setting**

None

**Command Mode**

Privileged Exec

This command sets the local port number of the LOG client for logging messages.

**Syntax****logging syslog port <portid>****no logging syslog port**

**no** - Resets the local logging port to the default.

**Default Setting**

None

**Command Mode**

Privileged Exec

**6.5.4.5 clear logging buffered**

This command clears all in-memory log.

**Syntax****clear logging buffered**

**Default Setting**

None

**Command Mode**

Privileged Exec

## 6.6 Script Management Commands

### 6.6.1 script apply

This command applies the commands in the configuration script to the switch. The apply command backs up the running configuration and then starts applying the commands in the script file. Application of the commands stops at the first failure of a command.

**Syntax**

```
script apply <scriptname>
```

**<scriptname>** - The name of the script to be applied.

**Default Setting**

None

**Command Mode**

Privileged Exec

### 6.6.2 script delete

This command deletes a specified script or all the scripts presented in the switch.

**Syntax**

```
script delete {<scriptname> | all}
```



**<scriptname>** - The name of the script to be deleted.

**all** - Delete all scripts presented in the switch

**Default Setting**

None

**Command Mode**

Privileged Exec

**6.6.3 script list**

This command lists all scripts present on the switch as well as the total number of files present.

**Syntax**

```
script list
```

**Default Setting**

None

**Command Mode**

Privileged Exec

**6.6.4 script show**

This command displays the content of a script file.

**Syntax**

```
script show <scriptname>
```

<scriptname> - Name of the script file.

### Default Setting

None

### Command Mode

Privileged Exec

## 6.7 User Account Management Commands

### 6.7.1 Show Commands

#### 6.7.1.1 show users

This command displays the configured user names and their settings. This command is only available for users with readwrite privileges. The SNMPv3 fields will only be displayed if SNMP is available on the system.

#### Syntax

```
show users
```

### Default Setting

None

### Command Mode

Privileged Exec

### Display Message

**User Name:** The name the user will use to login using the serial port, Telnet or Web. A new user may be added to the switch by entering a name in a blank entry. The user name may be up to eight characters, and is not case sensitive. Two users are included as the factory default, admin, and guest.

**User Access Mode:** Shows whether the operator is able to change parameters on the switch (Read/Write) or is only able to view them (Read Only). As a factory default, admin has Read/Write access and guest has Read Only access. There can only be one Read/Write

user and up to five Read Only users.

**SNMPv3 AccessMode:** This field displays the SNMPv3 Access Mode. If the value is set to **Read- Write**, the SNMPv3 user will be able to set and retrieve parameters on the system. If the value is set to **ReadOnly**, the SNMPv3 user will only be able to retrieve parameter information. The SNMPv3 access mode may be different from the CLI and Web access mode.

**SNMPv3 Authentication:** This field displays the authentication protocol to be used for the specified login user.

**SNMPv3 Encryption:** This field displays the encryption protocol to be used for the specified login user.

### 6.7.1.2 show users account information

The user can go to the CLI Privilege Mode to get all of user information, use the **show users accounts** Privilege command

<b>Syntax</b>
<b>show users accounts</b>

#### Default Setting

None

#### Command Mode

Privileged Exec

#### Display Message

**User Name:** The local user account's user name.

**Access Mode:** The user's access level (read-only or read/write).

**Lockout Status:** Indicates whether the user account is locked out (true or false).

**Password Expiration Date:** The current password expiration date in date format.

## 6.7.2 Configuration Commands

### 6.7.2.1 username

This command adds a new user (account) if space permits. The account <username> can be up to eight characters in length. The name may be comprised of alphanumeric characters as well as the dash ('-') and underscore ('\_'). The <username> is not case-sensitive. Six user names can be defined.

This command changes the password of an existing operator. User password should not be more than eight characters in length. If a user is authorized for authentication or encryption is enabled, the password must be eight alphanumeric characters in length. The username and password are not case-sensitive. When a password is changed, a prompt will ask for the

operator's former password. If none, press enter.

**Syntax**

```
username <username> {password | nopassword}  
no username <username>
```

**<username>** - is a new user name (Range: up to 8 characters).

**no** - This command removes a user name created before.

**Note:** The admin user account cannot be deleted.

**nopassword** - This command sets the password of an existing operator to blank. When a password is changed, a prompt will ask for the operator's former password. If none, press enter.

**Default Setting**

No password

**Command Mode**

Global Config

**6.7.2.2 Unlock a locked user account**

The user can go to the CLI Global Configuration Mode to unlock a locked user account, use the **username <name> unlock** global configuration command.

**Syntax**

```
username <username> unlock
```

**<name>** - is a user name (Range: up to 8 characters).

**Default Setting**

None

**Command Mode**

Global Config

**6.7.2.3 Set encrypted the password**

The user can go to the CLI Global Configuration Mode to set encrypted the password, use the **username <name> passwd encrypted <passwd>**Global configuration command.

**Syntax**

```
username <username> passwd encrypted <passwd>
```

**<name>** - is a user name (Range: up to 8 characters).

**<passwd>** - is a login password

**Default Setting**

None

**Command Mode**

Global Config

**6.7.2.4 username snmpv3 authentication**

This command specifies the authentication protocol to be used for the specified login user. The valid authentication protocols are **none**, **md5** or **sha**. If **md5** or **sha** are specified, the user login password will be used as the snmpv3 authentication password. The <username> is the login user name for which the specified authentication protocol will be used.

**Syntax**

```
username snmpv3 authentication <username> {none | md5 | sha}
```

```
no username snmpv3 authentication <username>
```

**<username>** - is the login user name.

**md5** - md5 authentication method.

**sha** - sha authentication method.

**none** - no use authentication method.

**no** - This command sets the authentication protocol to be used for the specified login user to **none**. The <username> is the login user name for which the specified authentication protocol will be used.

**Default Setting**

No authentication

## Command Mode

Global Config

### 6.7.2.5 username snmpv3 encryption

This command specifies the encryption protocol and key to be used for the specified login user. The valid encryption protocols are **none** or **des**. The **des** protocol requires a **key**, which can be specified on the command line. The **key** may be up to 16 characters. If the **des** protocol is specified but a key is not provided, the user will be prompted to enter the key. If **none** is specified, a key must not be provided. The <username> is the login user name for which the specified encryption protocol will be used.

#### Syntax

```
username snmpv3 encryption <username> {none | des [<key>]}  
no username snmpv3 encryption <username>
```

<username> - is the login user name.

**des** - des encryption protocol.

**none** - no encryption protocol.

**no** - This command sets the encryption protocol to **none**. The <username> is the login user name for which the specified encryption protocol will be used.

## Default Setting

No encryption

## Command Mode

Global Config

### 6.7.2.6 Set the password aging

The user can go to the CLI Global Configuration Mode to set the password aging, use the **passwords aging <1-365>** interface configuration command. Use the **no passwords aging** return to default value 0.

#### Syntax

```
passwords aging <1-365>  
no passwords aging
```

**Default Setting**

0

**Command Mode**

Global Config

**6.7.2.7 Set the password history**

The user can go to the CLI Global Configuration Mode to set the password history, use the **passwords history <0-10>** Global configuration command. Use the **no passwords history** return to default value 0.

**Syntax**

```
passwords history <0-10>  
no passwords history
```

**Default Setting**

0

**Command Mode**

Global Config

**6.7.2.8 Set the password lock-out count**

The user can go to the CLI Global Configuration Mode to set the password lock-out count, use the **passwords lock-out <1-5>** Global configuration command. Use the **no passwords lock-out** to return to default value 0.

**Syntax**

```
passwords lock-out <1-5>  
no passwords lock-out
```

**Default Setting**

0

**Command Mode**

Global Config

### 6.7.2.9 Set the minimum password length

The user can go to the CLI Global Configuration Mode to set the minimum password length, use the **passwords min-length <8-64>** Global configuration command. Use the **no passwords min-length** return to default value 8.

**Syntax**

```
passwords min-length <8-64>  
no passwords min-length
```

**Default Setting**

8

**Command Mode**

Global Config

## 6.8 Security Commands

### 6.8.1 Show Commands

#### 6.8.1.1 show users authentication

This command displays all users and all authentication login information. It also displays the authentication login list assigned to the default user.

**Syntax**

```
show users authentication
```

**Default Setting**

None

**Command Mode**

Privileged Exec

**Display Message**

**User:** This field lists every user that has an authentication login list assigned.

**System Login:** This field displays the authentication login list assigned to the user for system login.



**802.1x:** This field displays the authentication login list assigned to the user for 802.1x port security.

### 6.8.1.2 show authentication

This command displays the ordered authentication methods for all authentication login lists.

<b>Syntax</b>
---------------

<b>show authentication</b>
----------------------------

#### Default Setting

None

#### Command Mode

Privileged Exec

#### Display Message

**Authentication Login List:** This displays the authentication login listname.

**Method 1:** This displays the first method in the specified authentication login list, if any.

**Method 2:** This displays the second method in the specified authentication login list, if any.

**Method 3:** This displays the third method in the specified authentication login list, if any.

### 6.8.1.3 show authentication users

This command displays information about the users assigned to the specified authentication login list. If the login is assigned to non-configured users, the user "default" will appear in the user column.

<b>Syntax</b>
---------------

<b>show authentication users &lt;listname&gt;</b>
---

**<listname>** - the authentication login listname.

#### Default Setting

None

**Command Mode**

Privileged Exec

**Display Message****User Name:** This field displays the user assigned to the specified authentication login list.**Component:** This field displays the component (User or 802.1x) for which the authentication login list is assigned.**6.8.1.4 show dot1x**

This command is used to show the status of the dot1x Administrative mode.

**Syntax**

```
show dot1x
```

**Default Setting**

None

**Command Mode**

Privileged Exec

**Display Message****Administrative mode:** Indicates whether authentication control on the switch is enabled or disabled.**6.8.1.5 show dot1x detail**

This command is used to show a summary of the global dot1x configuration and the detailed dot1x configuration for a specified port.

**Syntax**

```
show dot1x detail <slot/port>
```

**<slot/port>** - is the desired interface number.

**Default Setting**

None

**Command Mode**

Privileged Exec

**Display Message****Port:** The interface whose configuration is displayed**Protocol Version:** The protocol version associated with this port. The only possible value is 1, corresponding to the first version of the dot1x specification.**PAE Capabilities:** The port access entity (PAE) functionality of this port. Possible values are Authenticator or Supplicant.**Authenticator PAE State:** Current state of the authenticator PAE state machine. Possible values are Initialize, Disconnected, Connecting, Authenticating, Authenticated, Aborting, Held, ForceAuthorized, and ForceUnauthorized.**Backend Authentication State:** Current state of the backend authentication state machine. Possible values are Request, Response, Success, Fail, Timeout, Idle, and Initialize.**Quiet Period:** The timer used by the authenticator state machine on this port to define periods of time in which it will not attempt to acquire a supplicant. The value is expressed in seconds and will be in the range of 0 to 65535.**Transmit Period:** The timer used by the authenticator state machine on the specified port to determine when to send an EAPOL EAP Request/Identity frame to the supplicant. The value is expressed in seconds and will be in the range of 1 to 65535.**Guest VLAN ID:** The guest VLAN identifier configured on the interface.**Guest VLAN Period:** The timer used by authenticator state machine on this port.**Supplicant Timeout:** The timer used by the authenticator state machine on this port to timeout the supplicant. The value is expressed in seconds and will be in the range of 1 to 65535.**Server Timeout:** The timer used by the authenticator on this port to timeout the authentication server. The value is expressed in seconds and will be in the range of 1 to 65535.**Maximum Requests:** The maximum number of times the authenticator state machine on this port will retransmit an EAPOL EAP Request/Identity before timing out the supplicant. The value will be in the range of 1 to 10.**Reauthentication Period:** The timer used by the authenticator state machine on this port to determine when reauthentication of the supplicant takes place. The value is expressed in seconds and will be in the range of 1 to 65535.**Reauthentication Enabled:** Indicates if reauthentication is enabled on this port. Possible values are True or False.**Key Transmission Enabled:** Indicates if the key is transmitted to the supplicant for the specified port. Possible values are True or False.**Control Direction:** Indicates the control direction for the specified port or ports. Possible values are both or in.**6.8.1.6 show dot1x statistics**

This command is used to show a summary of the global dot1x configuration and the dot1x statistics for a specified port.

**Syntax**

```
show dot1x statistics <slot/port>
```

<slot/port> - is the desired interface number.

**Default Setting**

None

**Command Mode**

Privileged Exec

**Display Message**

**Port:** The interface whose statistics are displayed.

**EAPOL Frames Received:** The number of valid EAPOL frames of any type that have been received by this authenticator.

**EAPOL Frames Transmitted:** The number of EAPOL frames of any type that have been transmitted by this authenticator.

**EAPOL Start Frames Received:** The number of EAPOL start frames that have been received by this authenticator.

**EAPOL Logoff Frames Received:** The number of EAPOL logoff frames that have been received by this authenticator.

**Last EAPOL Frame Version:** The protocol version number carried in the most recently received EAPOL frame.

**Last EAPOL Frame Source:** The source MAC address carried in the most recently received EAPOL frame.

**EAP Response/Id Frames Received:** The number of EAP response/identity frames that have been received by this authenticator.

**EAP Response Frames Received:** The number of valid EAP response frames (other than resp/id frames) that have been received by this authenticator.

**EAP Request/Id Frames Transmitted:** The number of EAP request/identity frames that have been transmitted by this authenticator.

**EAP Request Frames Transmitted:** The number of EAP request frames (other than request/identity frames) that have been transmitted by this authenticator.

**Invalid EAPOL Frames Received:** The number of EAPOL frames that have been received by this authenticator in which the frame type is not recognized.

**EAP Length Error Frames Received:** The number of EAPOL frames that have been received by this authenticator in which the frame type is not recognized.

**6.8.1.7 show dot1x summary**

This command is used to show a summary of the global dot1x configuration and summary

information of the dot1x configuration for a specified port or all ports.

**Syntax**

```
show dot1x summary {<slot/port> | all}
```

**<slot/port>** - is the desired interface number.

**all** - All interfaces.

**Default Setting**

None

**Command Mode**

Privileged Exec

**Display Message**

**Interface:** The interface whose configuration is displayed.

**Control Mode:** The configured control mode for this port. Possible values are force-unauthorized / force-authorized / auto.

**Operating Control Mode:** The control mode under which this port is operating. Possible values are authorized / unauthorized.

**Reauthentication Enabled:** Indicates whether re-authentication is enabled on this port.

**Port Status:** Indicates if the key is transmitted to the supplicant for the specified port.

**6.8.1.8 show dot1x users**

This command displays 802.1x port security user information for locally configured users.

**Syntax**

```
show dot1x users <slot/port>
```

**<slot/port>** - is the desired interface number.

**Default Setting**

None

**Command Mode**

Privileged Exec

**Display Message**

**User:** Users configured locally to have access to the specified port.

**6.8.1.9 show radius-servers**

This command is used to display items of the configured RADIUS servers.

**Syntax**

```
show radius-servers
```

**Default Setting**

None

**Command Mode**

Privileged Exec

**Display Message**

**IP Address:** IP Address of the configured RADIUS server

**Port:** The port in use by this server

**Type:** Primary or secondary

**Secret Configured:** Yes / No

**Message Authenticator:** The message authenticator attribute configured for the radius server.

**6.8.1.10 show radius**

This command is used to display the various RADIUS configuration items for the switch.

**Syntax**

```
show radius
```

**Default Setting**

None

**Command Mode**

Privileged Exec

### Display Message

**Current Server IP Address:** Indicates the configured server currently in use for authentication

**Number of configured servers:** The configured IP address of the authentication server

**Number of retransmits:** The configured value of the maximum number of times a request packet is retransmitted

**Timeout Duration:** The configured timeout value, in seconds, for request re-transmissions

**RADIUS Accounting Mode:** Disable or Enabled

#### 6.8.1.11 show radius accounting

This command is used to display the configured RADIUS accounting mode, accounting server, and the statistics for the configured accounting server.

<b>Syntax</b>
---------------

<b>show radius accounting [statistics &lt;ipaddr&gt;]</b>
---

<ipaddr> - is an IP Address.

### Default Setting

None

### Command Mode

Privileged Exec

### Display Message

If the optional token 'statistics <ipaddr>' is not included, then only the accounting mode and the RADIUS accounting server details are displayed.

**RADIUS Accounting Mode:** Enabled or disabled

**IP Address:** The configured IP address of the RADIUS accounting server

**Port:** The port in use by the RADIUS accounting server

**Secret Configured:** Yes or No

If the optional token 'statistics <ipaddr>' is included, the statistics for the configured RADIUS accounting server are displayed. The IP address parameter must match that of a previously configured RADIUS accounting server. The following information regarding the statistics of the RADIUS accounting server is displayed.

**RADIUS Accounting Server IP Address:** IP Address of the configured RADIUS accounting

server

**Round Trip Time:** The time interval in centiseconds, between the most recent Accounting-Response and the Accounting-Request that matched it from the RADIUS accounting server.

**Requests:** The number of RADIUS Accounting-Request packets sent to this accounting server. This number does not include retransmissions.

**Retransmission:** The number of RADIUS Accounting-Request packets retransmitted to this RADIUS accounting server.

**Responses:** The number of RADIUS packets received on the accounting port from this server.

**Malformed Responses:** The number of malformed RADIUS Accounting-Response packets received from this server. Malformed packets include packets with an invalid length. Bad authenticators and unknown types are not included as malformed accounting responses.

**Bad Authenticators:** The number of RADIUS Accounting-Response packets containing invalid authenticators received from this accounting server.

**Pending Requests:** The number of RADIUS Accounting-Request packets sent to this server that have not yet timed out or received a response.

**Timeouts:** The number of accounting timeouts to this server.

**Unknown Types:** The number of RADIUS packets of unknown types, which were received from this server on the accounting port.

**Packets Dropped:** The number of RADIUS packets received from this server on the accounting port and dropped for some other reason.

#### 6.8.1.12 show radius statistics

This command is used to display the statistics for RADIUS or configured server. To show the configured RADIUS server statistic, the IP Address specified must match that of a previously configured RADIUS server. On execution, the following fields are displayed.

<b>Syntax</b>
---------------

<b>show radius statistics [&lt;ipaddr&gt;]</b>
--

<ipaddr> - is an IP Address.

#### Default Setting

None

#### Command Mode

Privileged Exec

#### Display Message

If an IP address is not specified then only the Invalid Server Addresses field is displayed. Otherwise, the other listed fields are displayed.



**Invalid Server Addresses:** The number of RADIUS Access-Response packets received from unknown addresses.

**Server IP Address:** The IP address of radius server.

**Round Trip Time:** The time interval, in hundredths of a second, between the most recent Access-Reply/ Access-Challenge and the Access-Request that matched it from the RADIUS authentication server.

**Access Requests:** The number of RADIUS Access-Request packets sent to this server. This number does not include retransmissions.

**Access Retransmission:** The number of RADIUS Access-Request packets retransmitted to this RADIUS authentication server.

**Access Accepts:** The number of RADIUS Access-Accept packets, including both valid and invalid packets, which were received from this server.

**Access Rejects:** The number of RADIUS Access-Reject packets, including both valid and invalid packets, which were received from this server.

**Access Challenges:** The number of RADIUS Access-Challenge packets, including both valid and invalid packets, which were received from this server.

**Malformed Access Responses:** The number of malformed RADIUS Access-Response packets received from this server. Malformed packets include packets with an invalid length. Bad authenticators or signature attributes or unknown types are not included as malformed access responses.

**Bad Authenticators:** The number of RADIUS Access-Response packets containing invalid authenticators or signature attributes received from this server.

**Pending Requests:** The number of RADIUS Access-Request packets destined for this server that have not yet timed out or received a response.

**Timeouts:** The number of authentication timeouts to this server.

**Unknown Types:** The number of RADIUS packets of unknown types, which were received from this server on the authentication port.

**Packets Dropped:** The number of RADIUS packets received from this server on the authentication port and dropped for some other reason.

### 6.8.1.13 show tacacs

This command display configured information and statistics of a TACACS+ server.

<b>Syntax</b>
---------------

<b>show tacacs [&lt;ip-address&gt;]</b>
---

< ip-address > - is an IP Address.

#### Default Setting

None

#### Command Mode

Privileged Exec

### Display Message

**IP address:** Shows the IP address of the configured TACACS+ server.

**Port:** Shows the configured TACACS+ server port number.

**TimeOut:** Shows the timeout in seconds for establishing a TCP connection.

**Priority:** Shows the preference order in which TACACS+ servers are contacted. If a server connection fails, the next highest priority server is contacted.

#### 6.8.1.14 show port-security

This command shows the port-security settings for the entire system.

<b>Syntax</b>
---------------

<b>show port-security</b>
---------------------------

### Default Setting

None

### Command Mode

Privileged Exec

### Display Message

**Port Security Administration Mode:** Port lock mode for the entire system.

This command shows the port-security settings for a particular interface or all interfaces.

<b>Syntax</b>
---------------

<b>show port-security { &lt;slot/port&gt;   all }</b>
---

### Default Setting

None

### Command Mode

Privileged Exec

## Display Message

**Intf** Interface Number.

**Interface Admin Mode** Port Locking mode for the Interface.

**Dynamic Limit** Maximum dynamically allocated MAC Addresses.

**Static Limit** Maximum statically allocated MAC Addresses.

**Violation Trap Mode** Whether violation traps are enabled.

This command shows the dynamically locked MAC addresses for port.

### Syntax

```
show port-security dynamic <slot/port>
```

## Default Setting

None

## Command Mode

Privileged Exec

## Display Message

**MAC address** Dynamically locked MAC address.

This command shows the statically locked MAC addresses for port.

### Syntax

```
show port-security static <slot/port>
```

## Default Setting

None

## Command Mode

Privileged Exec

## Display Message

**MAC address** Statically locked MAC address.

This command displays the source MAC address of the last packet that was discarded on a

locked port.

**Syntax**

```
show port-security violation <slot/port>
```

**Default Setting**

None

**Command Mode**

Privileged Exec

**Display Message**

**MAC address** MAC address of discarded packet on locked ports.

## 6.8.2 Configuration Commands

### 6.8.2.1 authentication login

This command creates an authentication login list. The **<listname>** is up to 15 alphanumeric characters and is not case sensitive. Up to 10 authentication login lists can be configured on the switch. When a list is created, the authentication method “local” is set as the first method.

When the optional parameters “method1”, “method 2”, and/or “method 3” are used, an ordered list of methods are set in the authentication login list. If the authentication login list does not exist, a new authentication login list is first created and then the authentication methods are set in the authentication login list. The maximum number of authentication login methods is three. **The possible method values are local, radius, reject, and tacacs.**

The value of **local** indicates that the user’s locally stored ID and password are used for authentication. The value of **radius** indicates that the user’s ID and password will be authenticated using the RADIUS server. The value of **reject** indicates that the user is never authenticated. The value of **tacacs** indicates that the user’s ID and password will be authenticated using the TACACS.

To authenticate a user, the authentication methods in the user’s login will be attempted in order until an authentication attempt succeeds or fails.

Note that the default login list included with the default configuration cannot be changed.

**Syntax**

```
authentication login <listname> [<method1>] [<method2>] [<method3>]  
no authentication login <listname>
```

**<listname>** - creates an authentication login list (Range: up to 15 characters).

**<method1 - 3>** - The possible method values are local, radius, reject, and tacacs.

**no** - This command deletes the specified authentication login list. The attempt to delete will fail if any of the following conditions are true:

1. The login list name is invalid or does not match an existing authentication login list
2. The specified authentication login list is assigned to any user or to the nonconfigured user for any component.
3. The login list is the default login list included with the default configuration and was not created using 'config authentication login create'. The default login list cannot be deleted.

**Default Setting**

None

**Command Mode**

Global Config

**6.8.2.2 username defaultlogin**

This command assigns the authentication login list to use for non-configured users when attempting to log in to the system. This setting is overridden by the authentication login list assigned to a specific user if the user is configured locally. If this value is not configured, users will be authenticated using local authentication only.

**Syntax**

```
username defaultlogin <listname>
```

**<listname>** - an authentication login list.

**Default Setting**

None

**Command Mode**

Global Config

### 6.8.2.3 username login

This command assigns the specified authentication login list to the specified user for system login. The **<username>** must be a configured **<username>** and the **<listname>** must be a configured login list.

If the user is assigned a login list that requires remote authentication, all access to the interface from all CLI, web, and telnet sessions will be blocked until the authentication is complete.

Note that the login list associated with the 'admin' user cannot be changed to prevent accidental lockout from the switch.

<b>Syntax</b>
---------------

<b>username login &lt;user&gt; &lt;listname&gt;</b>
---

**<user>** - is the login user name.

**<listname>** - an authentication login list.

#### Default Setting

None

#### Command Mode

Global Config

## 6.8.3 Dot1x Configuration Commands

### 6.8.3.1 dot1x initialize

This command begins the initialization sequence on the specified port. This command is only valid if the control mode for the specified port is 'auto'. If the control mode is not 'auto' an error will be returned.

<b>Syntax</b>
---------------

```
dot1x initialize <slot/port>
```

<slot/port> - is the desired interface number.

**Default Setting**

None

**Command Mode**

Privileged Exec

**6.8.3.2 dot1x default-login**

This command assigns the authentication login list to use for non-configured users for 802.1x port security. This setting is over-ridden by the authentication login list assigned to a specific user if the user is configured locally. If this value is not configured, users will be authenticated using local authentication only.

**Syntax**

```
dot1x default-login <listname>
```

<listname> - an authentication login list.

**Default Setting**

None

**Command Mode**

Global Config

**6.8.3.3 dot1x login**

This command assigns the specified authentication login list to the specified user for 802.1x port security. The <user> parameter must be a configured user and the <listname> parameter must be a configured authentication login list.

**Syntax**

```
dot1x login <user> <listname>
```

<user> - is the login user name.

<listname> - an authentication login list.

**Default Setting**

None

**Command Mode**

Global Config

**6.8.3.4 dot1x system-auth-control**

This command is used to enable the dot1x authentication support on the switch. By default, the authentication support is disabled. While disabled, the dot1x configuration is retained and can be changed, but is not activated.

**Syntax**

```
dot1x system-auth-control  
no dot1x system-auth-control
```

**no** - This command is used to disable the dot1x authentication support on the switch.

**Default Setting**

Disabled

**Command Mode**

Global Config

**6.8.3.5 dot1x user**

This command adds the specified user to the list of users with access to the specified port or all ports. The <username> parameter must be a configured user.



**Syntax**

```
dot1x user <user> {<slot/port> | all}  
no dot1x user <user> {<slot/port> | all}
```

**<user>** - Is the login user name.

**<slot/port>** - Is the desired interface number.

**all** - All interfaces.

**no** - This command removes the user from the list of users with access to the specified port or all ports.

**Default Setting**

None

**Command Mode**

Global Config

**6.8.3.6 dot1x port-control**

This command sets the authentication mode to be used on all ports. The control mode may be one of the following.

**force-unauthorized:** The authenticator PAE unconditionally sets the controlled port to unauthorized.

**force-authorized:** The authenticator PAE unconditionally sets the controlled port to authorized.

**auto:** The authenticator PAE sets the controlled port mode to reflect the outcome of the authentication exchanges between the supplicant, authenticator, and the authentication server.

**Syntax**

```
dot1x port-control all {auto | force-authorized | force-unauthorized}  
no dot1x port-control all
```

**all** - All interfaces.

**no** - This command sets the authentication mode to be used on all ports to 'auto'.

**Default Setting**

auto

### Command Mode

Global Config

This command sets the authentication mode to be used on the specified port. The control mode may be one of the following.

**force-unauthorized:** The authenticator PAE unconditionally sets the controlled port to unauthorized.

**force-authorized:** The authenticator PAE unconditionally sets the controlled port to authorized.

**auto:** The authenticator PAE sets the controlled port mode to reflect the outcome of the authentication exchanges between the supplicant, authenticator, and the authentication server.

#### Syntax

```
dot1x port-control {auto | force-authorized | force-unauthorized}
no dot1x port-control
```

**no** - This command sets the authentication mode to be used on the specified port to 'auto'.

### Default Setting

auto

### Command Mode

Interface Config

#### 6.8.3.7 dot1x host-mode

The command will configure the host mode to a specified port, use the **dot1x host-mode {single-host | multi-host}** interface configuration command. Use the **no dot1x host-mode** to return authentication mode to default value.

#### Syntax

```
dot1x host-mode {single-host | multi-host}
no dot1x host-mode
```

**< single-host >** - Sets single mode.

**< multi-host >** - Sets multi mode.

**no** - This command sets authentication mode to default value.

### Default Setting

Multi-host

### Command Mode

Interface Config

#### 6.8.3.8 dot1x max-req

This command sets the maximum number of times the authenticator state machine on this port will transmit an EAPOL EAP Request/Identity frame before timing out the supplicant. The <1-10> value must be in the range 1 - 10.

<b>Syntax</b>
<b>dot1x max-req &lt;1-10&gt;</b> <b>no dot1x max-req</b>

**<1-10>** - maximum number of times (Range: 1 – 10).

**no** - This command sets the maximum number of times the authenticator state machine on this port will transmit an EAPOL EAP Request/Identity frame before timing out the supplicant to the default value, that is, 2.

### Default Setting

2

### Command Mode

Interface Config

#### 6.8.3.9 dot1x max-user

This command configures the maximum users to a specified port, The system's default maximum users of an interface has no limitation. If '**no dot1x max-users**' command is executed, the system will reset the maximum users to infinity. If the maximum users is specified

or modified, the system should use the new one.

**Syntax**

```
dot1x max-user <number>  
no dot1x max-user
```

**<number>** - maximum users (Range: 0 – 600).

**no** - This command sets the system will reset the maximum users to infinity

**Default Setting**

no limitation

**Command Mode**

Interface Config

**6.8.3.10 dot1x re-authentication**

This command enables re-authentication of the supplicant for the specified port.

**Syntax**

```
dot1x re-authentication  
no dot1x re-authentication
```

**no** - This command disables re-authentication of the supplicant for the specified port.

**Default Setting**

Disabled

**Command Mode**

Interface Config

**6.8.3.11 dot1x re-reauthenticate**

This command begins the re-authentication sequence on the specified port. This command is only valid if the control mode for the specified port is 'auto'. If the control mode is not 'auto' an error will be returned.

**Syntax**

```
dot1x re-authenticate <slot/port>
```

**<slot/port>** - is the desired interface number.

**Default Setting**

None

**Command Mode**

Privileged Exec

**6.8.3.12 dot1x timeout**

This command sets the value, in seconds, of the timer used by the authenticator state machine on this port. Depending on the token used and the value (in seconds) passed; various timeout configurable parameters are set. The following tokens are supported.

**reauth-period:** Sets the value, in seconds, of the timer used by the authenticator state machine on this port to determine when re-authentication of the supplicant takes place. The reauth-period must be a value in the range 1 - 65535.

**quiet-period:** Sets the value, in seconds, of the timer used by the authenticator state machine on this port to define periods of time in which it will not attempt to acquire a supplicant. The quiet-period must be a value in the range 0 - 65535.

**tx-period:** Sets the value, in seconds, of the timer used by the authenticator state machine on this port to determine when to send an EAPOL EAP Request/Identity frame to the supplicant. The quiet-period must be a value in the range 1 - 65535.

**supp-timeout:** Sets the value, in seconds, of the timer used by the authenticator state machine on this port to timeout the supplicant. The supp-timeout must be a value in the range 1 - 65535.

**server-timeout:** Sets the value, in seconds, of the timer used by the authenticator state

machine on this port to timeout the authentication server. The supp-timeout must be a value in the range 1 - 65535.

**Syntax**

```
dot1x timeout {quiet-period | reauth-period | server-timeout | supp-timeout | tx-period}
<seconds>
no dot1x timeout {quiet-period | reauth-period | server-timeout | supp-timeout |
tx-period}
```

**<seconds>** - Value in the range 0 – 65535.

**no** - This command sets the value, in seconds, of the timer used by the authenticator state machine on this port to the default values. Depending on the token used, the corresponding default values are set.

**Default Setting**

reauth-period: 3600 seconds  
quiet-period: 60 seconds  
tx-period: 30 seconds  
supp-timeout: 30 seconds  
server-timeout: 30 seconds

**Command Mode**

Interface Config

**6.8.3.13 dot1x guest vlan**

This command configures the Guest VLAN capability on the interface. The command specifies an active VLAN as an IEEE 802.1x guest VLAN.

**Syntax**

```
dot1x guest- vlan <vlan-id>
no dot1x guest-vlan
```

**no** - This command disables the Guest VLAN capability on this interface.

**Default Setting**

disabled

**Command Mode**

Interface Config

**6.8.3.14 dot1x guest-vlan**

This command configures the Guest VLAN to be assigned to supplicants that have failed authentication.

**Syntax**

```
dot1x guest-vlan supplicant
no dot1x guest-vlan supplicant
```

**no** - This command disables the Guest VLAN supplicant on the switch.

**Default Setting**

disabled

**Command Mode**

Global Config

**6.8.3.15 dot1x timeout guest-vlan-period**

Use this command to set the value, in seconds, of the timer used by the authenticator state machine on this port to timeout the authentication server.

**Syntax**

```
dot1x timeout guest-vlan-period <seconds>
no dot1x timeout quest-vlan-period
```

**no** - This command sets the timer used by authenticator state machine on this port to the default value.

**Default Setting**

90

**Command Mode**

Global Config

## 6.8.4 Radius Configuration Commands

### 6.8.4.1 radius accounting mode

This command is used to enable the RADIUS accounting function.

**Syntax**

```
radius accounting mode  
no radius accounting mode
```

**no** - This command is used to set the RADIUS accounting function to the default value - that is, the RADIUS accounting function is disabled.

**Default Setting**

Disabled

**Command Mode**

Global Config

### 6.8.4.2 radius server attribute 4

This command to set the NAS-IP address for the radius server.

**Syntax**



```
radius-server attribute 4 [ipaddr]
no radius-server attribute 4
```

**no** – use this command to reset the NAS-IP address for the radius server..

#### Default Setting

None

#### Command Mode

Global Config

### 6.8.4.3 radius-server dead-time

This command configures radius server dead time.

#### Syntax

```
radius-server dead-time <value>
no radius-server dead-time
```

**Value** - Set radius server dead time (sec). Range 1 – 255.

**no** - This command is used to set dead time to the default value.

#### Default Setting

255

#### Command Mode

Global Config

### 6.8.4.4 radius-server host

This command is used to configure the RADIUS authentication and accounting server. If the '**auth**' token is used, the command configures the IP address to use to connect to a RADIUS authentication server. Up to 3 servers can be configured per RADIUS client. If the maximum number of configured servers is reached, the command will fail until one of the servers is removed by executing the **no** form of the command. If the optional **<port>** parameter is used, the command will configure the UDP port number to use to connect to the configured RADIUS server. In order to configure the UDP port number, the IP address must match that of a previously configured RADIUS authentication server. The port number must lie between 1 -

65535, with 1812 being the default value.

If the '**acct**' token is used, the command configures the IP address to use for the RADIUS accounting server. Only a single accounting server can be configured. If an accounting server is currently configured, it must be removed from the configuration using the no form of the command before this command succeeds. If the optional **<port>** parameter is used, the command will configure the UDP port to use to connect to the RADIUS accounting server. The IP address specified must match that of a previously configured accounting server. If a port is already configured for the accounting server then the new port will replace the previously configured value. The port must be a value in the range 1 - 65535, with 1813 being the default value.

**Syntax**

```
radius-server host {acct | auth} <ipaddr> [port]
no radius-server host {acct | auth} <ipaddr>
```

**<ipaddr>** - is a IP address.

**[port]** - Port number (Range: 1 – 65535)

**no** - This command is used to remove the configured RADIUS authentication server or the RADIUS accounting server. If the 'auth' token is used, the previously configured RADIUS authentication server is removed from the configuration. Similarly, if the 'acct' token is used, the previously configured RADIUS accounting server is removed from the configuration. The <ipaddr> parameter must match the IP address of the previously configured RADIUS authentication / accounting server.

**Default Setting**

None

**Command Mode**

Global Config

**6.8.4.5 radius-sever key**

This command is used to configure the shared secret between the RADIUS client and the RADIUS accounting / authentication server. Depending on whether the '**auth**' or '**acct**' token is used, the shared secret will be configured for the RADIUS authentication or RADIUS accounting server. The IP address provided must match a previously configured server. When this command is executed, the secret will be prompted. The secret must be an alphanumeric value not exceeding 20 characters.

**Syntax**

```
radius-server key {acct | auth} <ipaddr> {<key-string>|encrypted <password>}
```

<ipaddr> - is a IP address.

<key-string> - radius key string.

<password> is the password in encrypted format.

**Default Setting**

None

**Command Mode**

Global Config

**6.8.4.6 radius-server retransmit**

This command sets the maximum number of times a request packet is re-transmitted when no response is received from the RADIUS server. The retries value is an integer in the range of 1 to 15.

**Syntax**

```
radius-server retransmit <retries>
```

```
no radius-server retransmit
```

<retries> - the maximum number of times (Range: 1 - 15).

**no** - This command sets the maximum number of times a request packet is re-transmitted, when no response is received from the RADIUS server, to the default value, that is, 10.

**Default Setting**

10

**Command Mode**

Global Config

#### 6.8.4.7 radius-server timeout

This command sets the timeout value (in seconds) after which a request must be retransmitted to the RADIUS server if no response is received. The timeout value is an integer in the range of 1 to 30.

<b>Syntax</b>
---------------

<b>radius-server timeout &lt;seconds&gt;</b> <b>no radius-server timeout</b>
---

**<seconds>** - the maximum timeout (Range: 1 - 30).

**no** - This command sets the timeout value (in seconds) after which a request must be retransmitted to the RADIUS server if no response is received, to the default value, that is, 6.

#### Default Setting

6

#### Command Mode

Global Config

#### 6.8.4.8 radius-server msgauth

This command enables the message authenticator attribute for a specified server.

<b>Syntax</b>
---------------

<b>radius-server msgauth &lt;ipaddr&gt;</b>
---

**<ipaddr>** - is a IP address.

#### Default Setting

None

#### Command Mode

Global Config

#### 6.8.4.9 radius-server primary

This command is used to configure the primary RADIUS authentication server for this RADIUS client. The primary server is the one that is used by default for handling RADIUS requests. The remaining configured servers are only used if the primary server cannot be reached. A maximum of three servers can be configured on each client. Only one of these servers can be configured as the primary. If a primary server is already configured prior to this command being executed, the server specified by the IP address specified used in this command will become the new primary server. The IP address must match that of a previously configured RADIUS authentication server.

**Syntax**

```
radius-server primary <ipaddr>
```

<ipaddr> - is a IP address.

**Default Setting**

None

**Command Mode**

Global Config

### 6.8.5 TACACS+ Configuration Commands

#### 6.8.5.1 tacacs host

This command is used to enable /disable TACACS+ function and to configure the TACACS+ server IP address. The system has not any TACACS+ server configured for its initialization and support 5 TACACS+ servers.

**Syntax**

```
tacacs host <ip-address>  
no tacacs host <ip-address>
```

<ip-address> - The TACACS+ server IP address you want to configure.

**no** - This command is used to remove all of configuration.

**Default Setting**

None

**Command Mode**

Global Config

**6.8.5.2 tacacs key**

This command is used to configure the TACACS+ authentication and encryption key.

**Syntax**

```
tacacs key <key-string>
no tacacs key
```

Note that the length of the secret key is up to 128 characters.

**< key-string >** - The valid value of the key.

**no** - This command is used to remove the TACACS+ server secret key.

**Default Setting**

None

**Command Mode**

Global Config

This command is used to configure the TACACS+ authentication and encryption key.

**Syntax**

```
key <key-string>
```

Note that the length of the secret key is up to 128 characters.

**< key-string >** - The valid value of the key.

**Default Setting**

None

**Command Mode**

Tacacs Host Config

This command is used to configure the TACACS+ authentication host port.

**Syntax**

```
port <port-number>
```

< port-number > - The valid port number. Range (0 – 65535)>

**Default Setting**

49

**Command Mode**

Tacacs Host Config

This command is used to configure the TACACS+ authentication host priority.

**Syntax**

```
priority <priority>
```

< priority > - The valid priority number. Range (0 – 65535)>

**Default Setting**

0

**Command Mode**

Tacacs Host Config

**6.8.5.3 tacacs timeout**

This command is used to configure the TACACS+ connection timeout value.

**Syntax**

```
tacacs timeout <timeout>  
no tacacs timeout
```

**<timeout>** - The connection timeout value. Max timeout (Range: 1 to 30).

**no** - This command is used to reset the timeout value to the default value.

**Default Setting**

5

**Command Mode**

Global Config

This command is used to configure the TACACS+ connection timeout value.

**Syntax**

```
timeout <timeout>
```

**<timeout>** - The connection timeout value. Max timeout (Range: 1 to 30).

**Default Setting**

5

**Command Mode**

Tacacs Host Config

## 6.8.6 Port Security Configuration Commands

### 6.8.6.1 port-security

This command enables port locking at the system level (Global Config) or port level (Interface Config).



**Syntax**

```
port-security  
no port-security
```

**Default Setting**

None

**Command Mode**

Global Config, Interface Config

**6.8.6.2 port-security max-dynamic**

This command sets the maximum of dynamically locked MAC addresses allowed on a specific port.

**Syntax**

```
port-security max-dynamic [<0-600>]  
no port-security max-dynamic
```

**no** - This command resets the maximum of dynamically locked MAC addresses allowed on a specific port to its default value.

**Default Setting**

600

**Command Mode**

Interface Config

### 6.8.6.3 port-security max-static

This command sets the maximum number of statically locked MAC addresses allowed on a specific port.

#### Syntax

```
port-security max-static [<0-20>]
no port-security max-static
```

**no** - This command resets the maximum number of statically locked MAC addresses allowed on a specific port to its default value.

#### Default Setting

20

#### Command Mode

Interface Config

### 6.8.6.4 port-security mac-address

This command adds a MAC address to the list of statically locked MAC addresses.

#### Syntax

```
port-security mac-address <mac-addr> <1-3965>
no port-security mac-address <mac-addr> <1-3965>
```

**<1-3965> VLAN ID**

**<mac-addr>**

**no** - This command removes a MAC address from the list of statically locked MAC addresses.

**Default Setting**

None

**Command Mode**

Interface Config

**6.8.6.5 port-security mac-address move**

This command converts dynamically locked MAC addresses to statically locked addresses.

**Syntax**

```
port-security mac-address move
```

**Default Setting**

None

**Command Mode**

Interface Config

**6.8.6.6 port-security violation shutdown**

This command configures the port violation shutdown mode. Once the violation happens, the interface will be shutdown.

**Syntax**

```
port-security violation shutdown  
no port-security violation
```

**no** - This command restore violation mode to be default.

**Default Setting**

None

**Command Mode**

Interface Config

## 6.9 CDP (Cisco Discovery Protocol) Commands

### 6.9.1 Show Commands

#### 6.9.1.1 show cdp

This command displays the CDP configuration information.

<b>Syntax</b>
---------------

<code>show cdp</code>
-----------------------

**Default Setting**

None

**Command Mode**

Privileged Exec

**Display Message**

**CDP Admin Mode:** CDP enable or disable

**CDP Holdtime (sec):** The length of time a receiving device should hold the L2 Network Switch CDP information before discarding it

**CDP Transmit Interval (sec):** A period of the L2 Network Switch to send CDP packet

**Ports:** Port number vs CDP status

**CDP:** CDP enable or disable

#### 6.9.1.2 show cdp neighbors

This command displays the CDP neighbor information.

**Syntax**

```
show cdp neighbors
```

**Default Setting**

None

**Command Mode**

Privileged Exec

**Display Message**

**Device Id:** Identifies the device name in the form of a character string.

**Local Interface:** The CDP neighbor information receiving port.

**Holdtime:** The length of time a receiving device should hold CDP information before discarding it.

**Capability:** Describes the device's functional capability in the form of a device type, for example, a switch.

**Platform:** Describes the hardware platform name of the device, for example, Quanta the L2 Network Switch.

**Port Id:** Identifies the port on which the CDP packet is sent.

**6.9.1.3 show cdp traffic**

This command displays the CDP traffic counters information.

**Syntax**

```
show cdp traffic
```

**Default Setting**

None

**Command Mode**

Privileged Exec

**Display Message**

**Incoming packet number:** Received legal CDP packets number from neighbors.

**Outgoing packet number:** Transmitted CDP packets number from this device.

**Error packet number:** Received illegal CDP packets number from neighbors.

## 6.9.2 Configuration Commands

### 6.9.2.1 cdp

This command is used to enable CDP Admin Mode.

<b>Syntax</b>
---------------

<code>cdp</code> <code>no cdp</code>
---

**no** - This command is used to disable CDP Admin Mode.

#### Default Setting

Enabled

#### Command Mode

Global Config

### 6.9.2.2 cdp run

This command is used to enable CDP on a specified interface.

<b>Syntax</b>
---------------

<code>cdp run</code> <code>no cdp run</code>
---

**no** - This command is used to disable CDP on a specified interface.

#### Default Setting

Enabled

#### Command Mode

## Interface Config

This command is used to enable CDP for all interfaces.

**Syntax**

```
cdp run all
no cdp run all
```

**all** - All interfaces.

**no** - This command is used to disable CDP for all interfaces.

**Default Setting**

Enabled

**Command Mode**

Global Config

**6.9.2.3 cdp timer**

This command is used to configure an interval time (seconds) of the sending CDP packet.

**Syntax**

```
cdp timer <5-254>
no cdp timer
```

**<5-254>** - interval time (Range: 5 – 254).

**no** - This command is used to reset the interval time to the default value.

**Default Setting**

60

**Command Mode**

Global Config

**6.9.2.4 cdp holdtime**

This command is used to configure the hold time (seconds) of CDP.

**Syntax**

```
cdp holdtime <10-255>
```

**<10-255>** - interval time (Range: 10 – 255).

**no** - This command is used to hold time to the default value.

**Default Setting**

180

**Command Mode**

Global Config

**6.10 SNTP (Simple Network Time Protocol) Commands****6.10.1 Show Commands****6.10.1.1 show sntp**

This command displays the current time and configuration settings for the SNTP client, and indicates whether the local time has been properly updated.

**Syntax**

```
show sntp
```

**Default Setting**



None

**Command Mode**

Privileged Exec

**Display Message**

**Last Update Time** Time of last clock update.

**Last Unicast Attempt Time** Time of last transmit query (in unicast mode).

**Last Attempt Status** Status of the last SNTP request (in unicast mode) or unsolicited message (in broadcast mode).

**Broadcast Count** Current number of unsolicited broadcast messages that have been received and processed by the SNTP client since last reboot.

**Time Zone** Time zone configured.

This command displays SNTP client settings.

**Syntax**

```
show sntp client
```

**Default Setting**

None

**Command Mode**

Privileged Exec

**Display Message**

**Client Supported Modes** Supported SNTP Modes (Broadcast, Unicast, or Multicast).

**SNTP Version** The highest SNTP version the client supports.

**Port** SNTP Client Port

**Client Mode:** Configured SNTP Client Mode.

**Unicast Poll Interval** Poll interval value for SNTP clients in seconds as a power of two.

**Poll Timeout (Seconds)** Poll timeout value in seconds for SNTP clients.

**Poll Retry** Poll retry value for SNTP clients.

This command displays configured SNTP servers and SNTP server settings.

**Syntax**

```
show sntp server
```

**Default Setting**

None

**Command Mode**

Privileged Exec

**Display Message****Server IP Address** IP Address of configured SNTP Server**Server Type** Address Type of Server.**Server Stratum** Claimed stratum of the server for the last received valid packet.**Server Reference ID** Reference clock identifier of the server for the last received valid packet.**Server Mode** SNTP Server mode.**Server Max Entries** Total number of SNTP Servers allowed.**Server Current Entries** Total number of SNTP configured.*For each configured server:***IP Address** IP Address of configured SNTP Server.**Address Type** Address Type of configured SNTP server.**Priority** IP priority type of the configured server.**Version** SNTP Version number of the server. The protocol version used to query the server in unicast mode.**Port** Server Port Number**Last Attempt Time** Last server attempt time for the specified server.**Last Update Status** Last server attempt status for the server.**Total Unicast Requests** Number of requests to the server.**Failed Unicast Requests** Number of failed requests from server.

## 6.10.2 Configuration Commands

### 6.10.2.1 sntp broadcast client poll-interval

This command will set the poll interval for SNTP broadcast clients in seconds as a power of two where <poll-interval> can be a value from 6 to 16.

<b>Syntax</b>
<b>sntp broadcast client poll-interval &lt;6-10&gt;</b> <b>no sntp broadcast client poll-interval</b>

<6-10> - The range is 6 to 16.

**no** - This command will reset the poll interval for SNTP broadcast client back to its default value.

**Default Setting**

6

**Command Mode**

Global Config

**6.10.2.2 sntp client mode**

This command will enable Simple Network Time Protocol (SNTP) client mode and optionally setting the mode to either broadcast, multicast, or unicast.

**Syntax**

```
sntp client mode [broadcast | unicast]
no sntp client mode
```

**no** - This command will disable Simple Network Time Protocol (SNTP) client mode.

**Default Setting**

None

**Command Mode**

Global Config

**6.10.2.3 sntp client port**

This command will set the SNTP client port id and polling interval in seconds.

**Syntax**

```
sntp client port <portid> [<6-10>]  
no sntp client port
```

**<portid>** - SNTP client port id.

**<6-10>** - Polling interval. It's 2<sup>(value)</sup> seconds where value is 6 to 10.

**no** - Resets the SNTP client port id.

**Default Setting**

The default portid is 123.

**Command Mode**

Global Config

**6.10.2.4 sntp unicast client poll-interval**

This command will set the poll interval for SNTP unicast clients in seconds.

**Syntax**

```
sntp unicast client poll-interval <6-10>  
no sntp unicast client poll-interval
```

**<6-10>** - Polling interval. It's 2<sup>(value)</sup> seconds where value is 6 to 10.

**no** - This command will reset the poll interval for SNTP unicast clients to its default value.

**Default Setting**

The default value is 6.

**Command Mode**

Global Config

**6.10.2.5 sntp unicast client poll-timeout**

This command will set the poll timeout for SNTP unicast clients in seconds.

**Syntax**

```
sntp unicast client poll-timeout <poll-timeout>  
no sntp unicast client poll-timeout
```

**< poll-timeout >** - Polling timeout in seconds. The range is 1 to 30.

**no** - This command will reset the poll timeout for SNTP unicast clients to its default value.

**Default Setting**

The default value is 5.

**Command Mode**

Global Config

**6.10.2.6 sntp unicast client poll-retry**

This command will set the poll retry for SNTP unicast clients in seconds.

**Syntax**

```
sntp unicast client poll-retry <poll-retry>  
no sntp unicast client poll-retry
```

**< poll-retry >** - Polling retry in seconds. The range is 0 to 10.

**no** - This command will reset the poll retry for SNTP unicast clients to its default value.

**Default Setting**

The default value is 1.

**Command Mode**

Global Config

### 6.10.2.7 sntp server

This command configures an SNTP server (with a maximum of three) where the server address can be an ip address or a domain name and the address type either ipv4 or dns. The optional priority can be a value of 1-3, the version is a value of 1-4, and the port id is a value of 1-65535.

**Syntax**

```
sntp server <ipaddress/domain-name> <addresstype> [<1-3> [<version> [<portid>]]]
no sntp server remove <ipaddress/domain-name>
```

- < ipaddress/domain-name > - IP address of the SNTP server.
- < addresstype > - The address type is ipv4 or dns.
- <1-3> - The range is 1 to 3.
- <version> - The range is 1 to 4.
- <portid> - The range is 1 to 65535.
- no - This command deletes an server from the configured SNTP servers.

**Default Setting**

None.

**Command Mode**

Global Config

### 6.10.2.8 sntp clock timezone

This command sets the time zone for the switch's internal clock.

**Syntax**

```
sntp clock timezone <name> <0-12> <0-59> {before-utc | after-utc}
```

**<name>** - Name of the time zone, usually an acronym. (Range: 1-15 characters)

**<0-12>** - Number of hours before/after UTC. (Range: 0-12 hours)

**<0-59>** - Number of minutes before/after UTC. (Range: 0-59 minutes)

**before-utc** - Sets the local time zone before (east) of UTC.

**after-utc** - Sets the local time zone after (west) of UTC.

### Default Setting

Taipei 08:00 After UTC

### Command Mode

Global Config

## 6.11 MAC-Based Voice VLAN Commands

### 6.11.1 Show Commands

#### 6.11.1.1 show voice-vlan

This command uses to display the configuration status of the Voice VLAN on the switch.

<b>Syntax</b>
---------------

<b>show voice-vlan</b>
------------------------

### Default Setting

None

### Command Mode

Privileged Exec

### Display Message

**Vlan Voice-Vlan status:** The voice-vlan status (Enable/Disable).

**Voice-Vlan ID:** The specified VLAN to voice vlan.

**Voice Name:** The voice-name is the name of the voice device, which is to help the device management.

**MAC-Address:** A MAC address for which the switch has forwarding and or filtering information. The format is 6 or 8 two-digit hexadecimal numbers that are separated by colons, for example 01:23:45:67:89:AB. In an IVL system the MAC address will be displayed as 8 bytes.

**Mask:** The mac-mask is the last eight digit of the mask code of the MAC address, the valid values are: 0xff, 0xfe, 0xfc, 0xf8, 0xf0, 0xe0, 0xc0, 0x80 and 0x0.

**Priority:** The priority-id is the priority of the voice traffic; the valid range is 0 to 7.

### 6.11.1.2 show voice vlan

Use this command to display the configuration status of the Voice VLAN on the switch, When the interface parameter is not specified, only the global mode of the Voice VLAN is displayed.

<b>Syntax</b>
---------------

<b>show voice vlan [ interface { &lt;unit/slot/port&gt;   all }]</b>
--

#### Default Setting

None

#### Command Mode

Privileged Exec

User Exec

#### Display Message

**Voice VLAN Mode:** The admin mode of the Voice VLAN on the interface.

**Voice VLAN ID:** The Voice VLAN ID.

**Voice VLAN Priority:** The dot1p priority for the Voice VLAN on the port.

**Voice VLAN Untagged:** The tagging option for the Voice VLAN traffic.

**Voice VLAN CoS Override:** The Override option for the voice traffic arriving on the port.

**Voice VLAN Status:** The operational status of Voice VLAN on the port.

## 6.11.2 Configuration Commands

### 6.11.2.1 voice-vlan

This command is used to enable/disable Voice VLAN Admin Mode.



**Syntax**

```
voice-vlan  
no voice-vlan
```

**no** - This command is used to disable Voice VLAN Admin Mode.

**Default Setting**

Disabled

**Command Mode**

Global Config

**6.11.2.2 voice-vlan vlan**

This command configures the specified VLAN to Voice VLAN.

**Syntax**

```
voice-vlan vlan <vlan-id>
```

**Default Setting**

None

**Command Mode**

Global Config

**6.11.2.3 voice-vlan mac**

This command is used to add a voice device to a Voice VLAN.

**Syntax**

```
voice-vlan mac <mac-address> mask <mac-mask> priority <priority-id> [name
```

```
<voice-name>]
no voice-vlan {mac <mac-address>mask <mac-mask>|name <voice-name>| all}
```

**<mac-address>** - Configs voice vlan mac address.

**<mac-mask>** - Configs voice vlan mac mask.

**<priority-id>** - Configs voice vlan priority.

**<voice-name>** - Configs voice vlan name.

**no** - This command cancels the Voice VLAN configuration of this VLAN.

### Default Setting

None

### Command Mode

Global Config

#### 6.11.2.4 voice vlan

This command is used to enable/disable Voice VLAN Admin Mode.

<b>Syntax</b>
---------------

<pre>voice vlan no voice vlan</pre>
-------------------------------------

**no** - This command disables the Voice VLAN capability on this switch.

### Default Setting

Disabled

### Command Mode

Global Config

#### 6.11.2.5 voice vlan (Interface Config)

This command configures the Voice VLAN capability on the interface.

**Syntax**

```
voice vlan { vlanid <id> | dot1p <priority> | none | untagged }  
no voice vlan
```

**no** - This command disables the Voice VLAN capability on this switch.

**vlan-id** : Configure the IP phone to forward all voice traffic through the specified VLAN.

**dot1p** : Configure the IP phone to use 802.1p priority tagging for voice traffic and to use the default native VLAN (0) to carry all traffic. The valid <priority> range is 0 to 7.

**none** : Allow the IP phone to use its own configuration to send untagged voice traffic.

**untagged** : Configure the phone to send untagged voice traffic.

**Default Setting**

Disabled

**Command Mode**

Global Config

**6.11.2.6 voice vlan data priority**

Use this command to either trust or entrust the data traffic arriving on the Voice VLAN port.

**Syntax**

```
voice vlan data priority untrust | trust
```

**Default Setting**

trust

**Command Mode**

Global Config

## 6.12 LLDP (Link Layer Discovery Protocol) Commands

### 6.12.1 Show Commands

#### 6.12.1.1 show lldp

This command uses to display a summary of the current LLDP configuration.

<b>Syntax</b>
---------------

<code>show lldp</code>
------------------------

#### Default Setting

None

#### Command Mode

Privileged Exec

#### Display Message

**Transmit Interval:** Shows how frequently the system transmits local data LLDPDUs, in seconds.

**Transmit Hold Multiplier:** Shows the multiplier on the transmit interval that sets the TTL in local data LLDPDUs.

**Re-initialization Delay:** Shows the delay before re-initialization, in seconds.

**Notification Interval:** Shows how frequently the system sends remote data change notifications, in seconds.

#### 6.12.1.2 show lldp interface

This command uses to display a summary of the current LLDP configuration for a specific interface or for all interfaces.

<b>Syntax</b>
---------------

<code>show lldp interface {&lt;slot/port&gt;   all}</code>
--

**<slot/port>** - Configs a specific interface.

#### Default Setting

None

**Command Mode**

Privileged Exec

**Display Message**

**Interface:** Shows the interface in a slot/port format.

**Link:** Shows whether the link is up or down.

**Transmit:** Shows whether the interface transmits LLDPDUs.

**Receive:** Shows whether the interface receives LLDPDUs.

**Notify:** Shows whether the interface sends remote data change notifications.

**TLVs:** Shows whether the interface sends optional TLVs in the LLDPDUs. The TLV codes can be 0 (Port Description), 1 (System Name), 2 (System Description), or 3 (System Capability).

**Mgmt:** Shows whether the interface transmits system management address information in the LLDPDUs.

### 6.12.1.3 show lldp statistics

This command uses to display the current LLDP traffic and remote table statistics for a specific interface or for all interfaces.

<b>Syntax</b>
---------------

<b>show lldp statistics {&lt;slot/port&gt;   all}</b>
---

<slot/port> - Configs a specific interface.

**Default Setting**

None

**Command Mode**

Privileged Exec

**Display Message**

**Last Update:** Shows the amount of time since the last update to the remote table in days, hours, minutes, and seconds.

**Total Inserts:** Total number of inserts to the remote data table.

**Total Deletes:** Total number of deletes from the remote data table.

**Total Drops:** Total number of times the complete remote data received was not inserted due to insufficient resources.

**Total Ageouts:** Total number of times a complete remote data entry was deleted because the Time to Live interval expired.

The table contains the following column headings:

**Interface:** Shows the interface in slot/port format.

**Transmit Total:** Total number of LLDP packets transmitted on the port.

**Receive Total:** Total number of LLDP packets received on the port.

**Discards:** Total number of LLDP frames discarded on the port for any reason.

**Errors:** The number of invalid LLDP frames received on the port.

**Ageouts:** Total number of times a complete remote data entry was deleted for the port because the Time to Live interval expired.

**TVL Discards:** Shows the number of TLVs discarded

**TVL Unknowns:** Total number of LLDP TLVs received on the port where the type value is in the reserved range, and not recognized.

#### 6.12.1.4 show lldp remote-device

This command uses to display summary information about remote devices that transmit current LLDP data to the system. You can show information about LLDP remote data received on all ports or on a specific port.

<b>Syntax</b>
---------------

<b>show lldp remote-device {&lt;slot/port&gt;   all}</b>
--

**<slot/port>** - Displays a specific interface.

#### Default Setting

None

#### Command Mode

Privileged Exec

#### Display Message

**Local Interface:** Identifies the interface that received the LLDPDU from the remote device.

**Chassis ID:** Shows the ID of the remote device.

**Port ID:** Shows the port number that transmitted the LLDPDU.

**System Name:** Shows the system name of the remote device.

#### 6.12.1.5 show lldp remote-device detail

This command uses to display detailed information about remote devices that transmit current LLDP data to an interface on the system.

**Syntax**

```
show lldp remote-device detail <slot/port>
```

<slot/port> - Displays a specific interface.

**Default Setting**

None

**Command Mode**

Privileged Exec

**Display Message**

**Local Interface:** Identifies the interface that received the LLDPDU from the remote device.

**Chassis ID Subtype:** Shows the type of identification used in the Chassis ID field.

**Chassis ID:** Identifies the chassis of the remote device.

**Port ID Subtype:** Identifies the type of port on the remote device.

**Port ID:** Shows the port number that transmitted the LLDPDU.

**System Name:** Shows the system name of the remote device.

**System Description:** Describes the remote system by identifying the system name and versions of hardware, operating system, and networking software supported in the device.

**Port Description:** Describes the port in an alpha-numeric format. The port description is configurable.

**System Capabilities Supported:** Indicates the primary function(s) of the device.

**System Capabilities Enabled:** Shows which of the supported system capabilities are enabled.

**Management Address:** For each interface on the remote device with an LLDP agent, lists the type of address the remote LLDP agent uses and specifies the address used to obtain information related to the device.

**Time To Live:** Shows the amount of time (in seconds) the remote device's information received in the LLDPDU should be treated as valid information.

**6.12.1.6 show lldp local-device**

This command uses to display summary information about the advertised LLDP local data. This command can display summary information or detail for each interface.

**Syntax**

```
show lldp local-device {<slot/port> | all}
```

<slot/port> - Displays a specific interface.

**Default Setting**

None

**Command Mode**

Privileged Exec

**Display Message**

**Interface:** Identifies the interface in a slot/port format.

**Port ID:** Shows the port ID associated with this interface.

**Port Description:** Shows the port description associated with the interface.

**6.12.1.7 show lldp local-device detail**

This command uses to display detailed information about the LLDP data a specific interface transmits.

**Syntax**

```
show lldp local-device detail <slot/port>
```

<slot/port> - Displays a specific interface.

**Default Setting**

None

**Command Mode**

Privileged Exec

**Display Message**

**Interface:** Identifies the interface that sends the LLDPDU.

**Chassis ID Subtype:** Shows the type of identification used in the Chassis ID field.

**Chassis ID:** Identifies the chassis of the local device.

**Port ID Subtype:** Identifies the type of port on the local device.

**Port ID:** Shows the port number that transmitted the LLDPDU.

**System Name:** Shows the system name of the local device.

**System Description:** Describes the local system by identifying the system name and versions of hardware, operating system, and networking software supported in the device.

**Port Description:** Describes the port in an alpha-numeric format.

**System Capabilities Supported:** Indicates the primary function(s) of the device.

**System Capabilities Enabled:** Shows which of the supported system capabilities are enabled.



**Management Address:** Lists the type of address and the specific address the local LLDP agent uses to send and receive information.

### 6.12.1.8 show lldp med

The user can go to the CLI Privilege Mode to display a summary of the current LLDP-MED configuration, use the **show lldp med** Privilege command.

<b>Syntax</b>
---------------

<b>show lldp med</b>
----------------------

#### Default Setting

None

#### Command Mode

Privileged Exec

#### Display Message

**Fast Start Repeat Count:** Specifies the number of LLDP PDUs that will be transmitted when the protocol is enabled. The range is from (1 to 10). Default value of fast repeat count is 3.

**Device Class:** Specifies local device's MED Classification. There are four different kinds of devices, three of them represent the actual end points (classified as Class I Generic [IP Communication Controller etc.], Class II Media [Conference Bridge etc.], Class III Communication [IP Telephone etc.]). The fourth device is Network Connectivity Device, which is typically a LAN Switch/Router, IEEE 802.1 Bridge, IEEE 802.11 Wireless Access Point etc.

### 6.12.1.9 show lldp med interface

The user can go to the CLI Privilege Mode to display a summary of the current LLDP-MED configuration for a specific interface, use the **show lldp med interface {all | <unit/slot/port>}** Privilege command.

<b>Syntax</b>
---------------

<b>show lldp med interface {all   &lt;slot/port&gt;}</b>
--

#### Default Setting

None

#### Command Mode

Privileged Exec

## Display Message

**Interface:** Specifies all the ports on which LLDP-MED can be configured.

**Link:** Specifies the link status of the ports whether it is Up/Down.

**ConfigMED:** Specifies the LLDP-MED mode is enabled or disabled on this interface.

**OperMED:** Specifies the LLDP-MED TLVs are transmitted or not on this interface

**ConfigNotify:** Specifies the LLDP-MED topology notification mode of the interface.

**TLVsTx:** Specifies the LLDP-MED transmit TLV(s) that are included

### 6.12.1.10 show lldp med local-device detail

The user can go to the CLI Privilege Mode to display detailed information about the LLDP-MED data, use the **show lldp med local-device detail <unit/slot/port>** Privilege command.

<b>Syntax</b>
---------------

<b>show lldp med local-device detail &lt;slot/port&gt;</b>
--

## Default Setting

None

## Command Mode

Privileged Exec

## Display Message

**Network Policies** Specifies if network policy TLV is present in the LLDP frames.

**Media Policy Application Type** Specifies the application type. Types of application types are unknown, voicesignaling, guestvoice, guestvoicesignalling, softphonevoice, videoconferencing, streamingvideo, vidoesignalling. Each application type that is received has the VLAN id, priority, DSCP, tagged bit status and unknown bit status. A port may receive one or many such application types. If a network policy TLV has been transmitted only then would this information be displayed.

**Vlan ID** Specifies the VLAN id associated with a particular policy type.

**Priority** Specifies the priority associated with a particular policy type.

**DSCP** Specifies the DSCP associated with a particular policy type.

**Unknown** Specifies the unknown bit associated with a particular policy type.

**Tagged** Specifies the tagged bit associated with a particular policy type.

**Inventory** Specifies if inventory TLV is present in LLDP frames.

**Hardware Rev** Specifies hardware version.

**Firmware Rev** Specifies Firmware version.

**Software Rev** Specifies Software version.

**Serial Num** Specifies serial number.

**Mfg Name** Specifies manufacturers name.

**Model Name** Specifies model name.

**Asset ID** Specifies asset id.

**Location** Specifies if location TLV is present in LLDP frames.

**Subtype** Specifies type of location information.

**Info** Specifies the location information as a string for given type of location id.

**Extended POE** Specifies if local device is a PoE device.

**Device Type** Specifies power device type.

**Extended POE PSE** Specifies if extended PSE TLV is present in LLDP frame.

**Available** Specifies available power sourcing equipment's power value in tenths of watts on the port of local device.

**Source** Specifies power source of this port.

**Priority** Specifies PSE port power priority.

**Extended POE PD** Specifies if extended PD TLV is present in LLDP frame.

**Required** Specifies required power device power value in tenths of watts on the port of local device.

**Source** Specifies power source of this port.

**Priority** Specifies PD port power priority.

#### 6.12.1.11 show lldp med remote-device

The user can go to the CLI Privilege Mode to display the summary information about remote devices that transmit current LLDP-MED data to the system. use the **show lldp med remote-device {<slot/port> | all}** Privilege command.

<b>Syntax</b>
---------------

<b>show lldp med remote-device {&lt;slot/port&gt;   all}</b>
--

#### Default Setting

None

#### Command Mode

Privileged Exec

### Display Message

**Interface:** Specifies the list of all the ports on which LLDP-MED is enabled.

**Device Class:** Specifies local device's MED Classification. There are four different kinds of devices, three of them represent the actual end points (classified as Class I Generic [IP Communication Controller etc.], Class II Media [Conference Bridge etc.], Class III Communication [IP Telephone etc.]). The fourth device is Network Connectivity Device, which is typically a LAN Switch/Router, IEEE 802.1 Bridge, IEEE 802.11 Wireless Access Point etc.

#### 6.12.1.12 show lldp med remote-device detail

The user can go to the CLI Privilege Mode to display detailed information about remote devices that transmit current LLDP-MED data to an interface on the system, use the **show lldp med remote-device detail <slot/port>** Privilege command.

<b>Syntax</b>
---------------

<b>show lldp med remote-device detail &lt;slot/port&gt;</b>
---

### Default Setting

None

### Command Mode

Privileged Exec

### Display Message

#### Term Definition:

**Capabilities** Specifies the supported and enabled capabilities that was received in MED TLV on this port.

**MED Capabilities Supported** Specifies supported capabilities that was received in MED TLV on this port.

**MED Capabilities Enabled:** Specifies enabled capabilities that was received in MED TLV on this port.

**Device Class** Specifies device class as advertised by the device remotely connected to the port.

**Network Policies** Specifies if network policy TLV is received in the LLDP frames on this port.

**Media Policy Application Type** Specifies the application type. Types of application types are unknown, voicesignaling, guestvoice, guestvoicesignaling, softphonevoice, videoconferencing, streamingvideo, vidoesignalling. Each application type that is received has the VLAN id, priority, DSCP, tagged bit status and unknown bit status. A port may receive one or many such application types. If a network policy TLV has been received on this port only then would this information be displayed.

**Vlan ID** Specifies the VLAN id associated with a particular policy type.

**Priority** Specifies the priority associated with a particular policy type.

**DSCP** Specifies the DSCP associated with a particular policy type.

**Unknown** Specifies the unknown bit associated with a particular policy type.

**Tagged** Specifies the tagged bit associated with a particular policy type.

**Inventory** Specifies if inventory TLV is received in LLDP frames on this port.

**Hardware Rev** Specifies hardware version of the remote device.

**Firmware Rev** Specifies Firmware version of the remote device.

**Software Rev** Specifies Software version of the remote device.

**Serial Num** Specifies serial number of the remote device.

**Mfg Name** Specifies manufacturers name of the remote device.

**Model Name** Specifies model name of the remote device.

**Asset ID** Specifies asset id of the remote device.

**Location** Specifies if location TLV is received in LLDP frames on this port.

**Subtype** Specifies type of location information.

**Info** Specifies the location information as a string for given type of location id.

**Extended POE** Specifies if remote device is a PoE device.

**Device Type** Specifies remote device's PoE device type connected to this port.

**Extended POE PSE** Specifies if extended PSE TLV is received in LLDP frame on this port.

**Available** Specifies the remote ports PSE power value in tenths of watts.

**Source** Specifies the remote ports PSE power source.

**Priority** Specifies the remote ports PSE power priority.

**Extended POE PD** Specifies if extended PD TLV is received in LLDP frame on this port.

**Required** Specifies the remote port's PD power requirement.

**Source** Specifies the remote port's PD power source.

**Priority** Specifies the remote port's PD power priority.

## 6.12.2 Configuration Commands

### 6.12.2.1 Ildp notification

This command uses to enable remote data change notifications.

**Syntax**

```
lldp notification
no lldp notification
```

**no** - This command is used to disable notifications.

**Default Setting**

Disbaled

**Command Mode**

Interface Config

**6.12.2.2 lldp notification-interval**

This command is used to configure how frequently the system sends remote data change notifications. The <interval-seconds> parameter is the number of seconds to wait between sending notifications. The valid interval range is 5-3600 seconds.

**Syntax**

```
lldp notification-interval <interval-seconds>
no lldp notification-interval
```

**<interval-seconds>** - Configures the number of seconds to wait between sending notifications.

**no** - This command is used to return the notification interval to the default value.

**Default Setting**

5

**Command Mode**

Global Config

### 6.12.2.3 Ildp receive

This command uses to enable the LLDP receive capability.

<b>Syntax</b>
---------------

<b>lldp receive</b> <b>no lldp receive</b>
---

**no** - This command is used to return the reception of LLDPDUs to the default value.

#### Default Setting

Disable

#### Command Mode

Interface Config

### 6.12.2.4 Ildp transmit

This command uses to enable the LLDP advertise capability.

<b>Syntax</b>
---------------

<b>lldp transmit</b> <b>no lldp transmit</b>
---

**no** - This command is used to return the local data transmission capability to the default.

#### Default Setting

Disable

#### Command Mode

Interface Config

### 6.12.2.5 Ildp transmit-mgmt

This command uses to include transmission of the local system management address information in the LLDPDUs.

**Syntax**

```
lldp transmit-mgmt
no lldp transmit-mgmt
```

**no** - This command is used to cancel inclusion of the management information in LLDPDUs.

**Default Setting**

None

**Command Mode**

Interface Config

**6.12.2.6 lldp transmit-tlv**

This command is used to specify which optional type length values (TLVs) in the 802.1AB basic management set are transmitted in the LLDPDUs. Use `sys-name` to transmit the system name TLV. To configure the system name, please refer to “snmp-server” command. Use `sys-desc` to transmit the system description TLV. Use `sys-cap` to transmit the system capabilities TLV. Use `port-desc` to transmit the port description TLV. To configure the port description, please refer to “description” command.

**Syntax**

```
lldp transmit-tlv [sys-desc] [sys-name] [sys-cap] [port-desc]
no lldp transmit-tlv [sys-desc] [sys-name] [sys-cap] [port-desc]
```

**no** - This command is used to remove an optional TLV from the LLDPDUs. Use the command without parameters to remove all optional TLVs from the LLDPDU.

**Default Setting**

None

**Command Mode**

Interface Config



### 6.12.2.7 Ildp timers

This command is used to set the timing parameters for local data transmission on ports enabled for LLDP. The <interval-seconds> determines the number of seconds to wait between transmitting local data LLDPDUs. The range is 1-32768 seconds. The <hold-value> is the multiplier on the transmit interval that sets the TTL in local data LLDPDUs. The multiplier range is 2-10. The <reinit-seconds> is the delay before re-initialization, and the range is 1-0 seconds.

#### Syntax

```
lldp timers [interval <interval-seconds>] [hold <hold-value>] [reinit <reinit-seconds>]  
no lldp timers [interval] [hold] [reinit]
```

**<interval-seconds>** - Configures the number of seconds to wait between transmitting local data LLDPDUs

**<hold-value>** - Configures the multiplier on the transmit interval that sets the TTL in local data LLDPDUs

**<reinit-seconds>** - Configures the delay before re-initialization

**no** - This command is used to return any or all timing parameters for local data transmission on ports enabled for LLDP to the default values.

#### Default Setting

Interval-seconds 30

Hold-value 4

Reinit-seconds 2

#### Command Mode

Global Config

### 6.12.2.8 Ildp med

The user can go to the CLI Interface Configuration Mode to set MED to enable, use the **lldp med** Interface configuration command. Use the **no lldp med** to disable med function.

#### Syntax

```
lldp med  
no lldp med
```

**Default Setting**

Disable

**Command Mode**

Interface Config

**6.12.2.9 Ildp med confignotification**

The user can go to the CLI Interface Configuration Mode to set all the ports to send the topology change notification, use the **ildp med confignotification** Interface configuration command. Use the **no ildp med confignotification** to disable notifications.

**Syntax**

```
ildp med confignotification
no ildp med confignotification
```

**Default Setting**

Disable

**Command Mode**

Interface Config

**6.12.2.10 Ildp med transmit-tlv**

The user can go to the CLI Interface Configuration Mode to set Type Length Values (TLVs) in the LLDP MED, use the **ildp med transmit-tlv [capabilities] [ex-pd] [ex-pse] [inventory] [location][network-policy]** Interface configuration command. Use the **no ildp med transmit-tlv [capabilities] [ex-pd] [ex-pse] [inventory] [location][network-policy]** to remove the TLVs.

**Syntax**

```
ildp med transmit-tlv [capabilities] [ex-pd] [ex-pse] [inventory] [location]
[network-policy]
no ildp med transmit-tlv [capabilities] [ex-pd] [ex-pse] [inventory] [location]
[network-policy]
```

**capabilities** Transmit the LLDP capabilities TLV.

**ex-pd** Transmit the LLDP extended PD TLV.

**ex-pse** Transmit the LLDP extended PSE TLV.

**inventory** Transmit the LLDP inventory TLV.

**location** Transmit the LLDP location TLV.

**network-policy** Transmit the LLDP network policy TLV.

#### Default Setting

None

#### Command Mode

Interface Config

#### 6.12.2.11 lldp med all

The user can go to the CLI Global Configuration Mode to set LLDP-MED on all the ports, use the **lldp med all** Global configuration command. Use the **no lldp med all** to disable LLDP-MED on all the ports.

<b>Syntax</b>
---------------

<b>lldp med all</b> <b>no lldp med all</b>
---

#### Default Setting

Disable

#### Command Mode

Global config

#### 6.12.2.12 lldp med confignotification all

The user can go to the CLI Global Configuration Mode to set all the ports to send the topology change notification, use the **lldp med confignotification all** Global configuration command. Use the **no lldp med confignotification all** to remove all the ports to send the topology change notification.

<b>Syntax</b>
---------------

<b>lldp med confignotification all</b> <b>no lldp med confignotification all</b>
---

#### Default Setting

None

### Command Mode

Global Config

#### 6.12.2.13 lldp med faststartrepeatcount

The user can go to the CLI Global Configuration Mode to set the fast start repeat count, use the **lldp med faststartrepeatcount** Global configuration command. Use the **no lldp med faststartrepeatcount** to return the default value 3.

##### Syntax

```
lldp med faststartrepeatcount
no lldp med faststartrepeatcount
```

### Default Setting

3

### Command Mode

Global Config

#### 6.12.2.14 lldp med transmit-tlv all

The user can go to the CLI Global Configuration Mode to set Type Length Values (TLVs) in the LLDP-MED, use the **lldp med transmit-tlv all [capabilities] [ex-pd] [ex-pse] [inventory][location] [network-policy]** Global configuration command. Use the **no lldp med transmit-tlv all [capabilities] [ex-pd] [ex-pse] [inventory] [location] [network-policy]** to remove Type Length Values (TLVs) in the LLDP-MED

##### Syntax

```
lldp med transmit-tlv all [capabilities] [ex-pd] [ex-pse] [inventory] [location] [network-policy]
no lldp med transmit-tlv all [capabilities] [ex-pd] [ex-pse] [inventory] [location] [network-policy]
```

**capabilities** Transmit the LLDP capabilities TLV.

**ex-pd** Transmit the LLDP extended PD TLV.

**ex-pse** Transmit the LLDP extended PSE TLV.

**inventory** Transmit the LLDP inventory TLV.

**location** Transmit the LLDP location TLV.

**network-policy** Transmit the LLDP network policy TLV.

**Default Setting**

None

**Command Mode**

Global Config

## 6.13 Denial Of Service Commands

### 6.13.1 Show Commands

#### 6.13.1.1 show dos-control

This command displays the Denial of Service configurations for the entire system.

<b>Syntax</b>
---------------

<b>show dos-control</b>
-------------------------

**Default Setting**

None

**Command Mode**

Privileged Exec

**Display Message**

**SIPDIP Mode:** May be enabled or disabled. The factory default is disabled.

**First Fragment Mode:** May be enabled or disabled. The factory default is disabled.

**Min TCP Hdr Size:** range <0-255> the factory default is 20.

**TCP Fragment Mode:** May be enabled or disabled. The factory default is disabled.

**TCP Flag Mode:** May be enabled or disabled. The factory default is disabled.

**L4 Port Mode:** May be enabled or disabled. The factory default is disabled.

**ICMP Mode:** May be enabled or disabled. The factory default is disabled.

**Max ICMP Pkt Size:** range <0-1023> the factory default is 512.

**Max ICMPV6 Pkt Size:** range <0-1023> the factory default is 512.

## 6.13.2 Configuration Commands

### 6.13.2.1 dos-control sipdip

This command enables Source IP Address = Destination IP Address (SIP=DIP) Denial of Service protection. If the mode is enabled, Denial of Service prevention is active for this type of attack. If packets ingress with SIP=DIP, the packets will be dropped if the mode is enabled.

#### Syntax

```
dos-control sipdip
no dos-control sipdip
```

**no** - This command disables Source IP Address = Destination IP Address (SIP=DIP) Denial of Service prevention.

#### Default Setting

Disabled

#### Command Mode

Global Config

### 6.13.2.2 dos-control firstfrag

This command enables Minimum TCP Header Size Denial of Service protection. If the mode is enabled, Denial of Service prevention is active for this type of attack. If packets ingress having a TCP Header Size smaller than the configured value, the packets will be dropped if the mode is enabled. The default is disabled. If you enable dos-control firstfrag, but do not provide a Minimum TCP Header Size, the system sets that value to 20.

#### Syntax

```
dos-control firstfrag [<0-255>]
no dos-control firstfrag
```

**<0-255>** - This command sets minimum TCP header length

**no** - This command sets Minimum TCP Header Size Denial of Service protection to the default value of disabled.

**Default Setting**

Disable, 20

**Command Mode**

Global Config

**6.13.2.3 dos-control tcpfrag**

This command enables TCP Fragment Denial of Service protection. If the mode is enabled, Denial of Service prevention is active for this type of attack. If packets ingress having IP Fragment Offset equal to one (1), the packets will be dropped if the mode is enabled.

**Syntax**

```
dos-control tcpfrag
no dos-control tcpfrag
```

**no** - This command disabled TCP Fragment Denial of Service protection.

**Default Setting**

Disable

**Command Mode**

Global Config

**6.13.2.4 dos-control tcpflag**

This command enables TCP Flag Denial of Service protections. If the mode is enabled, Denial of Service prevention is active for this type of attacks. If packets ingress having TCP Flag SYN set and a source port less than 1024 or having TCP Control Flags set to 0 and TCP Sequence Number set to 0 or having TCP Flags FIN, URG, and PSH set and TCP Sequence Number set to 0 or having TCP Flags SYN and FIN both set, the packets will be dropped if the mode is enabled.

**Syntax**

```
dos-control tcpflag  
no dos-control tcpflag
```

**no** - This command sets disables TCP Flag Denial of Service protections.

**Default Setting**

Disable

**Command Mode**

Global Config

**6.13.2.5 dos-control l4port**

This command enables L4 Port Denial of Service protections. If the mode is enabled, Denial of Service prevention is active for this type of attack. If packets ingress having Source TCP/UDP Port Number equal to Destination TCP/UDP Port Number, the packets will be dropped if the mode is enabled.

**NOTE:** Some applications mirror source and destination L4 ports - RIP for example uses 520 for both. If you enable dos-control l4port, applications such as RIP may experience packet loss which would render the application inoperable.

**Syntax**

```
dos-control l4port  
no dos-control l4port
```

**no** - This command disables L4 Port Denial of Service protections.

**Default Setting**

Disable

**Command Mode**

Global Config

**6.13.2.6 dos-control icmp**

This command enables Maximum ICMP Packet Size Denial of Service protections. If the mode



is enabled, Denial of Service prevention is active for this type of attack. If ICMP Echo Request (PING) packets ingress having a size greater than the configured value, the packets will be dropped if the mode is enabled.

**Syntax**

```
dos-control icmp [<0-1023>]
no dos-control icmp
```

**<0-1023>** - This command sets maximum ICMP packet size.

**no** - This command disables Maximum ICMP Packet Size Denial of Service protections.

**Default Setting**

Disable, 512

**Command Mode**

Global Config

**6.13.2.7 dos-control icmpv6**

This command enables Maximum ICMPV6 Packet Size Denial of Service protections. If the mode is enabled, Denial of Service prevention is active for this type of attack. If ICMPV6 Echo Request (PING) packets ingress having a size greater than the configured value, the packets will be dropped if the mode is enabled.

**Syntax**

```
dos-control icmpv6 [<0-1023>]
no dos-control icmpv6
```

**<0-1023>** - This command sets maximum ICMPV6 packet size.

**no** - This command disables Maximum ICMPV6 Packet Size Denial of Service protections.

**Default Setting**

Disable, 512

**Command Mode**

Global Config

## 6.14 VTP (VLAN Trunking Protocol) Commands

### 6.14.1 Show Commands

#### 6.14.1.1 show vtp counters

This command displays the VTP packet statistics.

<b>Syntax</b>
<code>show vtp counters</code>

#### Default Setting

None

#### Command Mode

Privileged Exec

#### Display Message

**Summary advertisements received:**

**Subset advertisements received:**

**Request advertisements received:**

**Summary advertisements transmitted:**

**Subset advertisements transmitted:**

**Request advertisements transmitted:**

**Number of config revision errors:**

**Number of config digest errors:**

#### 6.14.1.2 show vtp password

This command displays the VTP domain password.

**Syntax**

```
show vtp password
```

**Default Setting**

None

**Command Mode**

Privileged Exec

**Display Message****VTP Password:** Displays the VTP domain password.**6.14.1.3 show vtp status**

This command displays the VTP domain status.

**Syntax**

```
show vtp status
```

**Default Setting**

None

**Command Mode**

Privileged Exec

**Display Message****VTP Status:****VTP Version:****Configuration Revision:****Maximum VTP supported VLANs:****VTP support VLAN number:****VTP Operating Mode:****VTP Domain Name:****VTP Pruning Mode:****MD5 digest:****Configuration last modified:**

#### 6.14.1.4 show vtp trunkport

This command displays the VTP trunkport status.

<b>Syntax</b>
---------------

<b>show vtp trunkport</b>
---------------------------

#### Default Setting

None

#### Command Mode

Privileged Exec

#### Display Message

**Port:** Displays the interface number.

**Trunkport:** Displays the trunkport status (enable or disable) on the interface number.

### 6.14.2 Configuration Commands

#### 6.14.2.1 vtp

This command uses to configure global VTP administrative mode.

<b>Syntax</b>
---------------

<b>vtp</b>
<b>no vtp</b>

**no** - This command disables global VTP administrative mode.

#### Default Setting

Disabled

#### Command Mode

Global Config

### 6.14.2.2 vtp domain

This command uses to set VTP administrative domain name.

#### Syntax

```
vtp domain <string>  
no vtp domain
```

**<string>** - Configures the string for domain name. (maximum length 32 bytes)

**no** - This command resets the domain name to NULL.

#### Default Setting

None

#### Command Mode

Global Config

### 6.14.2.3 vtp mode

This command uses to set VTP device mode. There are three modes you can configure, **Client**, **Server**, and **Transparent**.

#### Syntax

```
vtp mode { client | server | transparent }  
no vtp mode
```

**no** - This command resets the VTP mode to default value.

#### Default Setting

Transparent

**Command Mode**

Global Config

**6.14.2.4 vtp password**

This command uses to configure the VTP administrative domain password.

**Syntax**

```
vtp password <password>  
no vtp password
```

**<password>** - Configures VTP administrative domain password.(Max. length 64 bytes)

**no** - This command resets the VTP domain password to default value.

**Default Setting**

None

**Command Mode**

Global Config

**6.14.2.5 vtp pruning**

This command uses to configure the administrative domain to permit pruning

**Syntax**

```
vtp pruning  
no vtp pruning
```

**no** - This command resets the pruning mode to default value.

**Default Setting**

Disabled

**Command Mode**

Global Config

**6.14.2.6 vtp trunkport**

This command uses to configure the administrative domain trunk port for all of interfaces.

**Syntax**

```
vtp trunkport all  
no vtp trunkport all
```

**no** - This command resets the administrative domain trunk port to default value.

**Default Setting**

Disabled

**Command Mode**

Global Config

This command uses to configure the administrative domain trunk port on specific interfaces.

**Syntax**

```
vtp trunkport  
no vtp trunkport
```

**no** - This command resets the administrative domain trunk port to default value.

**Default Setting**

Disabled

**Command Mode**

## Interface Config

## 6.15 Protected Ports Commands

### 6.15.1 Show Commands

#### 6.15.1.1 show switchport protected

This command displays the status of all the interfaces, including protected and unprotected interfaces.

<b>Syntax</b>
---------------

<code>show switchport protected {all &lt;0-2&gt;}</code>
--

#### Default Setting

None

#### Command Mode

Privileged Exec

#### Display Message

**Name:** An name of the protected port group.

**Member Ports:** List of ports, which are configured as protected for the group identified with <groupid>. If no port is configured as protected for this group, this field is blank.

### 6.15.2 Configuration Commands

#### 6.15.2.1 switchport protected

This command used to modify a protected port group name. The <groupid> parameter identifies the set of protected ports. Use the name <name> pair to assign a name to the protected port group. The name can be up to 32 alphanumeric characters long, including blanks. The default is blank.

**NOTE:** Port protection occurs within a single switch. Protected port configuration does not affect traffic between ports on two different switches. No traffic forwarding is possible between two protected ports.



**Syntax**

```
switchport protected <0-2> name <name>  
no switchport protected <0-2> name
```

**<name>** - Assigns a name to the protected port group.

**no** - Remove a name from the protected port group.

**Default Setting**

None

**Command Mode**

Global Config

This command uses to add an interface to a protected port group. The <groupid> parameter identifies the set of protected ports to which this interface is assigned. You can only configure an interface as protected in one group.

**Syntax**

```
switchport protected <0-2>  
no switchport protected <0-2>
```

**no** - This command uses to configure a port as unprotected.

**Default Setting**

None

**Command Mode**

Interface Config

## 6.16 Static MAC Filtering Commands

### 6.16.1 Show Commands

#### 6.16.1.1 show mac-address-table static

This command displays the Static MAC Filtering information for all Static MAC Filters. If you select <all>, all the Static MAC Filters in the system are displayed. If you supply a value for <macaddr>, you must also enter a value for <vlanid>, and the system displays Static MAC Filter information only for that MAC address and VLAN.

<b>Syntax</b>
---------------

<b>show mac-address-table static {&lt;macaddr&gt; &lt;1-3965&gt;   all}</b>
---

<macaddr> - Static MAC address.

#### Default Setting

None

#### Command Mode

Privileged Exec

#### Display Message

**MAC Address:** Is the MAC Address of the static MAC filter entry.

**VLAN ID:** Is the VLAN ID of the static MAC filter entry.

**Source Port(s):** Indicates the source port filter set's slot and port(s).

### 6.16.2 Configuration Commands

#### 6.16.2.1 macfilter

This command adds a static MAC filter entry for the MAC address <macaddr> on the VLAN <vlanid>. The value of the <macaddr> parameter is a 6-byte hexadecimal number in the format of b1:b2:b3:b4:b5:b6.

The restricted MAC Addresses are: 00:00:00:00:00:00, 01:80:C2:00:00:00 to 01:80:C2:00:00:0F, 01:80:C2:00:00:20 to 01:80:C2:00:00:21, and FF:FF:FF:FF:FF:FF. The <vlanid> parameter must identify a valid VLAN. You can create up to 100 static MAC filters.

**Syntax**

```
macfilter <macaddr> <1-3965>  
no macfilter <macaddr> <1-3965>
```

**<macaddr>** - Specified a 6-byte hexadecimal number in the format of b1:b2:b3:b4:b5:b6.  
**no** - This command removes all filtering restrictions and the static MAC filter entry for the MAC address <macaddr> on the VLAN <vlanid>.

**Default Setting**

None

**Command Mode**

Global Config

**6.16.2.2 macfilter addsrc**

This command adds the interface to the source filter set for the MAC filter with the MAC address of <macaddr> and VLAN of <vlanid>. The <macaddr> parameter must be specified as a 6-byte hexadecimal number in the format of b1:b2:b3:b4:b5:b6. The <vlanid> parameter must identify a valid VLAN.

**Syntax**

```
macfilter addsrc <macaddr> <1-3965>  
no macfilter addsrc <macaddr> <1-3965>
```

**<macaddr>** - Specified a 6-byte hexadecimal number in the format of b1:b2:b3:b4:b5:b6.  
**no** - This command removes a port from the source filter set for the MAC filter with the MAC address of <macaddr> and VLAN of <vlanid>.

**Default Setting**

None

**Command Mode**

Interface Config

### 6.16.2.3 macfilter addsrc all

This command adds all interfaces to the source filter set for the MAC filter with the MAC address of <macaddr> and <vlanid>. You must specify the <macaddr> parameter as a 6-byte hexadecimal number in the format of b1:b2:b3:b4:b5:b6. The <vlanid> parameter must identify a valid VLAN.

**Syntax**

```
macfilter addsrc all <macaddr> <1-3965>  
no macfilter addsrc all <macaddr> <1-3965>
```

<macaddr> - Specified a 6-byte hexadecimal number in the format of b1:b2:b3:b4:b5:b6.

**no** - This command removes all interfaces to the source filter set for the MAC filter with the MAC address of <macaddr> and VLAN of <vlanid>.

**Default Setting**

None

**Command Mode**

Global Config

## 6.17 System Utilities

### 6.17.1 clear

#### 6.17.1.1 clear arp

This command causes all ARP entries of type dynamic to be removed from the ARP cache.

**Syntax**

```
clear arp
```

**Default Setting**

None

**Command Mode**

Privileged Exec

### 6.17.1.2 clear traplog

This command clears the trap log.

<b>Syntax</b>
---------------

<b>clear traplog</b>
----------------------

#### Default Setting

None

#### Command Mode

Privileged Exec

### 6.17.1.3 clear eventlog

This command is used to clear the event log, which contains error messages from the system.

<b>Syntax</b>
---------------

<b>clear eventlog</b>
-----------------------

#### Default Setting

None

#### Command Mode

Privileged Exec

### 6.17.1.4 clear logging buffered

This command is used to clear the message log maintained by the switch. The message log contains system trace information.

**Syntax**

```
clear logging buffered
```

**Default Setting**

None

**Command Mode**

Privileged Exec

**6.17.1.5 clear config**

This command resets the configuration to the factory defaults without powering off the switch. The switch is automatically reset when this command is processed. You are prompted to confirm that the reset should proceed.

**Syntax**

```
clear config
```

**Default Setting**

None

**Command Mode**

Privileged Exec

**6.17.1.6 clear pass**

This command resets all user passwords to the factory defaults without powering off the switch. You are prompted to confirm that the password reset should proceed.

**Syntax**

```
clear pass
```

**Default Setting**

None

**Command Mode**

Privileged Exec

**6.17.1.7 clear counters**

This command clears the stats for a specified <slot/port> or for all the ports or for the entire switch based upon the argument.

**Syntax**

```
clear counters [<slot/port> | all]
```

<slot/port> - is the desired interface number.

all - All interfaces.

**Default Setting**

None

**Command Mode**

Privileged Exec

**6.17.1.8 clear dns**

This command sets the DNS configuration to default value. The command will only clear the DNS statistics(used option command **counter**) or only clear all entries from the DNS cache(used option command **cache**).

**Syntax**

```
clear dns [counter | cache]
```

**counter** - this command clear the DNS statistics.

**cache** - this command clear all entries from the DNS cache.

**Default Setting**

None

**Command Mode**

Privileged Exec

**6.17.1.9 clear cdp**

This command is used to clear the CDP neighbors information and the CDP packet counters.

**Syntax**

```
clear cdp [traffic]
```

**traffic** - this command is used to clear the CDP packet counters.

**Default Setting**

None

**Command Mode**

Privileged Exec

**6.17.1.10 clear vlan**

This command resets VLAN configuration parameters to the factory defaults.

**Syntax**

```
clear vlan
```

**Default Setting**

None

**Command Mode**



Privileged Exec

#### 6.17.1.11 clear igmp snooping

This command clears the tables managed by the IGMP Snooping function and will attempt to delete these entries from the Multicast Forwarding Database.

<b>Syntax</b>
---------------

<b>clear igmp snooping</b>
----------------------------

#### Default Setting

None

#### Command Mode

Privileged Exec

#### 6.17.1.12 clear port-channel

This command clears all port-channels (LAGs).

<b>Syntax</b>
---------------

<b>clear port-channel</b>
---------------------------

#### Default Setting

None

#### Command Mode

Privileged Exec

#### 6.17.1.13 clear ip filter

This command is used to clear all ip filter entries.

**Syntax**

```
clear ip filter
```

**Default Setting**

None

**Command Mode**

Privileged Exec

**6.17.1.14 clear dot1x statistics**

This command resets the 802.1x statistics for the specified port or for all ports.

**Syntax**

```
clear dot1x statistics {all | <slot/port>}
```

**<slot/port>** - is the desired interface number.

**all** - All interfaces.

**Default Setting**

None

**Command Mode**

Privileged Exec

**6.17.1.15 clear radius statistics**

This command is used to clear all RADIUS statistics.

**Syntax**

```
clear radius statistics
```

**Default Setting**

None

**Command Mode**

Privileged Exec

**6.17.1.16 clear domain-list**

This command is used to clear all entries domain names for incomplete host names.

**Syntax**

```
clear domain-list
```

**Default Setting**

None

**Command Mode**

Privileged Exec

**6.17.1.17 clear hosts**

This command is used to clear all static host name-to-address mapping.

**Syntax**

```
clear hosts
```

**Default Setting**

None

**Command Mode**

Privileged Exec

**6.17.1.18 clear port-security dynamic address**

This command is used to clear the Dynamic MAC address by using the specified port (**interface <slot/port>**) or mac address (**address <mac-addr>**).

**Syntax**

```
clear port-security dynamic {address <mac-addr> | interface <slot/port> }
```

**<mac-addr>** - mac address you want to remove.

**<slot/port>** - mac address learning on this interface will be removed.

**Default Setting**

None

**Command Mode**

Privileged Exec

**6.17.1.19 clear ip arp-cache**

This command causes all ARP entries of type dynamic to be removed from the ARP cache. If the gateway keyword is specified, the dynamic entries of type gateway are purged as well. If interface keyword is specified, the dynamic entries of that interface on the ARP cache Table are purged.

**Syntax**

```
clear ip arp-cache [gateway | interface <slot/port>]
```

**<slot/port>** - Interface number.

**Default Setting**

None

**Command Mode**

Privileged Exec

**6.17.1.20 clear lldp statistics**

This command will use to reset all LLDP statistics.

**Syntax**

```
clear lldp statistics
```

**Default Setting**

None

**Command Mode**

Privileged Exec

**6.17.1.21 clear lldp remote-data**

This command will use to delete all information from the LLDP remote data table.

**Syntax**

```
clear lldp remote-data
```

**Default Setting**

None

**Command Mode**

Privileged Exec

### 6.17.1.22 enable passwd

This command changes Privileged EXEC password.

<b>Syntax</b>
---------------

<b>enable passwd</b>
----------------------

#### Default Setting

None

#### Command Mode

Global Config.

### 6.17.1.23 clear ipv6 neighbors

This command will use to clear all entries IPv6 neighbor table or an entry on a specific interface. Use the <slot/port> parameter to specify the interface.

<b>Syntax</b>
---------------

<b>clear ipv6 neighbors [&lt;slot/port&gt;]</b>
---

<slot/port> - Specify the interface.

#### Default Setting

None

#### Command Mode

Privileged Exec

### 6.17.1.24 clear ipv6 statistics

This command will use to clear IPv6 statistics for all interfaces or for a specific interface,

including loopback and tunnel interfaces. IPv6 statistics display in the output of the show ipv6 traffic command. If you do not specify an interface, the counters for all IPv6 traffic statistics reset to zero.

**Syntax**

```
clear ipv6 statistics [{<slot/port> | loopback <loopback-id> | tunnel <tunnel-id>}]
```

<slot/port> - Specify the interface.

<loopback-id > - Specify loopback Interface ID. Range 0 -7.

<tunnel-id > - Specify the Tunnel ID. Range 0 -7.

**Default Setting**

None

**Command Mode**

Privileged Exec

**6.17.1.25 clear ipv6 dhcp**

This command will use to clear DHCPv6 statistics for all interfaces or for a specific interface. Use the <slot/port> parameter to specify the interface.

**Syntax**

```
clear ipv6 dhcp {statistics | interface <slot/port> statistics}
```

<slot/port> - Specify the interface.

**Default Setting**

None

**Command Mode**

Privileged Exec

### 6.17.2 copy

This command uploads and downloads to/from the switch. Local URLs can be specified using tftp or xmodem. The following can be specified as the source file for uploading from the switch: startup config (startup-config), event log (eventlog), message log (msglog) and trap log (traplog). A URL is specified for the destination.

The command can also be used to download the startup config or code image by specifying the source as a URL and destination as startup-config or image respectively.

The command can be used to save the running config to flash by specifying the source as running-config and the destination as startup-config *{filename}*.

The command can also be used to download ssh key files as sshkey-rsa, sshkey-rsa2, and sshkey-dsa and http secure-server certificates as sslpem-root, sslpem-server, sslpem-dhweak, and sslpem-dhstrong.

Files upload to PC

#### Syntax

```
copy startup-config <sourcefilename> <url>
```

```
copy {errorlog | log | traplog} <url>
```

```
copy script <sourcefilename> <url>
```

```
copy image <filename> <url>
```

```
where <url>={xmodem | tftp://ipaddr/path/file | ftp://user:pass@ipaddr/path/file}
```

**<sourcefilename>** - The filename of a configuration file or a script file.

**<url>** - xmodem, tftp://ipaddr/path/file or ftp://user:pass@ipaddr/path/file.

**errorlog** - event Log file.

**log** - message Log file.

**traplog** - trap Log file.

**<filename>** - Operation code file name.

#### Default Setting

None

#### Command Mode

Privileged Exec



Files download from PC to board

**Syntax**

```
copy <url> startup-config <destfilename>
copy <url> image <destfilename>
copy <url> {sshkey-rsa1 | sshkey-rsa2 | sshkey-dsa}
copy <url> {sslpem-root | sslpem-server | sslpem-dhweak | sslpem-dhstrong}
copy <url> script <destfilename>

where <url>={xmodem | tftp://ipaddr/path/file | ftp://user:pass@ipaddr/path/file }
```

**<destfilename>** - name of the image file or the script file.

**<url>** - xmodem, tftp://ipaddr/path/file or ftp://user:pass@ipaddr/path/file.

**sshkey-rsa1** - SSH RSA1 Key file.

**sshkey-rsa2** - SSH RSA2 Key file.

**sshkey-dsa** - SSH DSA Key file.

**sslpem-root** - Secure Root PEM file.

**sslpem-server** - Secure Server PEM file.

**sslpem-dhweak** - Secure DH Weak PEM file.

**sslpem-dhstrong** - Secure DH Strong PEM file.

**Default Setting**

None

**Command Mode**

Privileged Exec

Write running configuration file into flash

**Syntax**

```
copy running-config startup-config [filename]
```

**<filename>** - name of the configuration file.

**Default Setting**

None

**Command Mode**

Privileged Exec

This command upload or download the pre-login banner file

**Syntax**

```
copy clibanner <url>  
copy <url> clibanner  
no clibanner
```

**<url>** - xmodem, tftp://ipaddr/path/file or ftp://user:pass/ipaddr/path/file.

**no** - Delete CLI banner.

**Default Setting**

None

**Command Mode**

Privileged Exec

**6.17.3 delete**

This command is used to delete a configuration or image file.

**Syntax**

```
delete <filename>
```

**<filename>** - name of the configuration or image file.

**Default Setting**

None

**Command Mode**

Privileged Exec

**6.17.4 dir**

This command is used to display a list of files in Flash memory.

<b>Syntax</b>
<b>dir [boot-rom   config   opcode [&lt;filename&gt;] ]</b>

**<filename>** - name of the configuration or image file.

**boot-rom** - bootrom.

**config** - configuration file.

**opcode** - run time operation code.

**Default Setting**

None

**Command Mode**

Privileged Exec

**Display Message**

<b>Column Heading</b>	<b>Description</b>
date	The date that the file was created.
file name	The name of the file.
file type	File types: Boot-Rom, Operation Code, and Config file.
startup	Shows if this file is used when the system is started.
size	The length of the file in bytes.

**6.17.5 whichboot**

This command is used to display which files were booted when the system powered up.

**Syntax**

```
whichboot
```

**Default Setting**

None

**Command Mode**

Privileged Exec

### 6.17.6 boot-system

This command is used to specify the file or image used to start up the system.

**Syntax**

```
boot-system {boot-rom | config | opcode} <filename>
```

**<filename>** - name of the configuration or image file.

**boot-rom** - bootrom.

**config** - configuration file.

**opcode** - run time operation code.

**Default Setting**

None

**Command Mode**

Privileged Exec

### 6.17.7 ping

#### 6.17.7.1 ping <host>

This command checks if another computer is on the network and listens for connections. To use this command, configure the switch for network (in-band) connection. The source and

target devices must have the ping utility enabled and running on top of TCP/IP. The switch can be pinged from any IP workstation with which the switch is connected through the default VLAN (VLAN 1), as long as there is a physical path between the switch and the workstation. The terminal interface sends, three pings to the target station.

**Syntax**

```
ping <host>
```

**<host>** - A host name or an IP address.

**Default Setting**

None

**Command Mode**

Privileged Exec

Ping on changing parameter value

**Syntax**

```
ping <host> count <0-20000000> [size <32-512>]  
ping <host> size <32-512> [count <0-20000000>]
```

**<ipaddr>** - an IP address.

**<0-20000000>** - number of pings (Range: 0 - 20000000). Note that 0 means infinite.

**<size>** - packet size (Range: 32 - 512).

**Default Setting**

Count = 5

Size = 32

**Command Mode**

Privileged Exec

**6.17.7.2 ping ipv6 <ipv6-address>**

This command use to determine whether another computer is on the network. To use the command, configure the switch for network (in-band) connection. The source and target devices must have the ping utility enabled and running on top of TCP/IP. The switch can be pinged from any IP workstation with which the switch is connected through the default VLAN (VLAN 1), as long as there is a physical path between the switch and the workstation. The terminal interface sends three pings to the target station. Use the <ipv6-address> parameter to ping an interface by using the global IPv6 address of the interface. Use the optional size keyword to specify the size of the ping packet.

**Syntax**

```
ping ipv6 <ipv6-address> [size <datagram-size>]
```

<ipv6-address> - A global IPv6 address.

<datagram-size> - Datagram size. Range 48 - 2048.

**Default Setting**

None

**Command Mode**

Privileged Exec

**6.17.7.3 ping ipv6 interface**

This command use to determine whether another computer is on the network. To use the command, configure the switch for network (in-band) connection. The source and target devices must have the ping utility enabled and running on top of TCP/IP. The switch can be pinged from any IP workstation with which the switch is connected through the default VLAN (VLAN 1), as long as there is a physical path between the switch and the workstation. The terminal interface sends three pings to the target station. Use the interface keyword to ping an interface by using the link-local address. You can use a loopback, tunnel, or logical interface as the source. Use the optional size keyword to specify the size of the ping packet.

**Syntax**

```
ping ipv6 interface {<slot/port> | tunnel <tunnel-id>} | loopback <loopback-id> {<link-local-address>} [size <datagram-size>]
```

<slot/port> - Specify the interface.

<tunnel-id > - Specify the Tunnel ID. Range 0 -7.

**<loopback-id >** - Specify loopback Interface ID. Range 0 -7.

**<link-local-address>** - Specify link-local address.

**<ipv6-address>** - Specify the IPv6 address of the device.

**<datagram-size>** - Datagram size. Range 48 - 2048.

### Default Setting

None

### Command Mode

Privileged Exec

## 6.17.8 traceroute

### 6.17.8.1 traceroute

Use the traceroute command to discover the routes that packets actually take when traveling to their destination through the network on a hop-by-hop basis. Traceroute continues to provide a synchronous response when initiated from the CLI.

#### Syntax

```
traceroute <ipaddr|hostname> [initTtl <initTtl>] [maxTtl <maxTtl>]  
[maxFail <maxFail>] [interval <interval>] [count <count>]  
[port <port>] [size <size>]
```

**<ipaddr>** - The IP address or destination host you want to trace.

**<initTtl>** - The Use initTtl to specify the initial time-to-live (TTL), the maximum number of router hops between the local and remote system. Range is 0 to 255.

**<maxTtl>** - Use maxTtle to specify the maximum TTL. Range is 1 to 255.

**<maxFail>** - Use maxFail to terminate the traceroute after failing to receive a response for this number of consecutive probes. Range is 0 to 255.

**<interval>** - Use interval to specify the time between probes, in seconds. Range is 1 to 60 seconds.

**<count>** - Use the optional count parameter to specify the number of probes to send for each TTL value. Range is 1 to 10 probes.

**<port>** - Use the optional port parameter to specify destination UDP port of the probe. This should be an unused port on the remote destination system. Range is 1 to 65535.

**<size>** - Use the optional size parameter to specify the size, in bytes, of the payload of the Echo Requests sent. Range is 0 to 65507 bytes.

**Default Setting**

None

**Command Mode**

Privileged Mode

**6.17.8.2 traceroute ipv6**

This command is used to discover the routes that packets actually take when traveling to their destination through the network on a hop-by-hop basis. The **<ipv6-address>** parameter must be a valid IPv6 address. The optional **<port>** parameter is the UDP port used as the destination of packets sent as part of the traceroute. This port should be an unused port on the destination system. The range for **<port>** is 0 (zero) to 65535. The default value is 33434.

**Syntax**

```
traceroute ipv6 <ipv6-address> [<port>]
```

**<ipv6-address>** - A valid IPv6 address.

**<port>** - A valid decimal integer in the range of 0 (zero) to 65535.

**Default Setting**

None

**Command Mode**

Privileged Exec

**6.17.9 logging cli-command**

This command enables the CLI command Logging feature. The Command Logging component enables the switch to log all Command Line Interface (CLI) commands issued on the system.



**Syntax**

```
logging cli-command
```

**Default Setting**

None

**Command Mode**

Global Config

**6.17.10 calendar set**

This command is used to set the system clock.

**Syntax**

```
calendar set <hh:mm:ss> <1-31> <1-12> <2000-2099>
```

**<hh:mm:ss>** - hh in 24-hour format (Range: 0 - 23), mm (Range: 0 - 59), ss (Range: 0 - 59)

**<1-31>** - Day of month. (Range: 1 - 31).

**<1-12>** - Month. (Range: 1 - 12).

**<2000-2099>** - Year (4-digit). (Range: 2000 - 2099).

**Default Setting**

None

**Command Mode**

Privileged Exec

**6.17.11 reload**

This command resets the switch without powering it off. Reset means that all network connections are terminated and the boot code executes. The switch uses the stored configuration to initialize the switch. You are prompted to confirm that the reset should proceed. A successful reset is indicated by the LEDs on the switch.

**Syntax**

```
reload [slot <unit> ]
```

<unit> - Reload the specified unit.

**Default Setting**

None

**Command Mode**

Privileged Exec

**6.17.12 configure**

This command is used to activate global configuration mode

**Syntax**

```
configure
```

**Default Setting**

None

**Command Mode**

Privileged Exec

**6.17.13 disconnect**

This command is used to close a telnet session.

**Syntax**

```
disconnect {<0-10> | all}
```

<0-11> - telnet session ID.

all - all telnet sessions.

**Default Setting**

None

**Command Mode**

Privileged Exec

**6.17.14 hostname**

This command is used to set the prompt string.

**Syntax**

```
hostname <prompt_string>
```

< prompt\_string > - Prompt string.

**Default Setting**

Quanta

**Command Mode**

Privileged Exec

**6.17.15 quit**

This command is used to exit a CLI session.

**Syntax**

```
quit
```

**Default Setting**

None

**Command Mode**

Privileged Exec

## 6.18 Differentiated Service Command

**Note:** *This Switching Command function can only be used on the QoS software version.*

This chapter contains the CLI commands used for the QOS Differentiated Services (DiffServ) package.

The user configures DiffServ in several stages by specifying:

1. Class

- creating and deleting classes
- defining match criteria for a class

**Note:** The only way to remove an individual match criterion from an existing class definition is to delete the class and re-create it.

2. Policy

- creating and deleting policies
- associating classes with a policy
- defining policy statements for a policy/class combination

3. Service

- adding and removing a policy to/from a directional (that is, inbound, outbound) interface

Packets are filtered and processed based on defined criteria. The filtering criteria are defined by a class. The processing is defined by a policy's attributes. Policy attributes may be defined on a per class instance basis, and it is these attributes that are applied when a match occurs.

Packet processing begins by testing the match criteria for a packet. A policy is applied to a packet when a class match within that policy is found.

Note that the type of class - all, any, or acl - has a bearing on the validity of match criteria specified when defining the class. A class type of 'any' processes its match rules in an ordered sequence; additional rules specified for such a class simply extend this list. A class type of 'acl' obtains its rule list by interpreting each ACL rule definition at the time the DiffServ class is created. Differences arise when specifying match criteria for a class type 'all', since only one value for each non-excluded match field is allowed within a class definition. If a field is already specified for a class, all subsequent attempts to specify the same field fail, including the cases where a field can be specified multiple ways through alternative formats. The exception to this is when the 'exclude' option is specified, in which case this restriction does not apply to the excluded fields.

The following class restrictions are imposed by the LB4A Series L3 Switch DiffServ design:

- nested class support limited to:
  - 'all' within 'all'
  - no nested 'not' conditions
  - no nested 'acl' class types
  - each class contains at most one referenced class

- hierarchical service policies not supported in a class definition
- access list matched by reference only, and must be sole criterion in a class
  - that is, ACL rules copied as class match criteria at time of class creation, with class type 'any'
  - implicit ACL 'deny all' rule also copied
  - no nesting of class type 'acl'

Regarding nested classes, referred to here as class references, a given class definition can contain at most one reference to another class, which can be combined with other match criteria. The referenced class is truly a reference and not a copy, since additions to a referenced class affect all classes that reference it. Changes to any class definition currently referenced by any other class must result in valid class definitions for all derived classes otherwise the change is rejected. A class reference may be removed from a class definition.

The user can display summary and detailed information for classes, policies, and services. All configuration information is accessible via the CLI, Web, and SNMP user interfaces.

### 6.18.1 General Commands

The following characteristics are configurable for the platform as a whole.

#### 6.18.1.1 `diffserv`

This command sets the DiffServ operational mode to active. While disabled, the DiffServ configuration is retained and can be changed, but it is not activated. When enabled, DiffServ services are activated.

<b>Syntax</b>
---------------

<code>diffserv</code>
-----------------------

#### Command Mode

Global Config

#### 6.18.1.2 `no diffserv`

This command sets the DiffServ operational mode to inactive. While disabled, the DiffServ configuration is retained and can be changed, but it is not activated. When enabled, DiffServ services are activated.

<b>Syntax</b>
---------------

```
no diffserv
```

## Command Mode

Global Config

### 6.18.2 Class Commands

The 'class' command set is used in DiffServ to define:

**Traffic Classification** specifies Behavior Aggregate (BA) based on DSCP, and Multi-Field (MF) classes of traffic (name, match criteria)

**Service Levels** specifies the BA forwarding classes / service levels. Conceptually, DiffServ is a two-level hierarchy of classes: 1. Service/PHB, 2. Traffic Class

This set of commands consists of class creation/deletion and matching, with the class match commands specifying layer 3, layer 2, and general match criteria. The class match criteria are also known as class rules, with a class definition consisting of one or more rules to identify the traffic belonging to the class. Note that once a class match criterion is created for a class, it cannot be changed or deleted - the entire class must be deleted and re-created.

The CLI command root is **class-map**.

#### 6.18.2.1 class-map

This command defines a new DiffServ class of type match-all, match-any or match-access-group.

##### Syntax

```
class-map [ match-all ] <class-map-name>
```

**<class-map-name>** is a case sensitive alphanumeric string from 1 to 31 characters uniquely identifying the class.

**Note:** The class name 'default' is reserved and must not be used here. When used without any match condition, this command enters the class-map mode. The **<class-map-name>** is the name of an existing DiffServ class.

**Note:** The class name 'default' is reserved and is not allowed here. The class type of **match-all** indicates all of the individual match conditions must be true for a packet to be considered a member of the class. The class type of **match-access-group** indicates the individual class match criteria are evaluated based on an access list (ACL).

**<aclid>** is an integer specifying an existing ACL number (refer to the appropriate ACL

documentation for the valid ACL number range). A **matchaccess-group** class type copies its set of match criteria from the current rule definition of the specified ACL number. All elements of a single ACL Rule are treated by DiffServ as a grouped set, similar to class type all. For any class, at least one class match condition must be specified for the class to be considered valid.

**Note:** The class match conditions are obtained from the referenced access list **at the time of class creation**. Thus, any subsequent changes to the referenced ACL definition do not affect the DiffServ class. To pick up the latest ACL definition, the DiffServ class must be deleted and recreated. This command may be used without specifying a class type to enter the Class-Map Config mode for an existing DiffServ class.

**Note:** The CLI mode is changed to Class-Map Config when this command is successfully executed.

**Command Mode**  
Global Config

#### 6.18.2.2 no class-map

This command eliminates an existing DiffServ class.

<b>Syntax</b>
---------------

<b>no class-map &lt;class-map-name&gt;</b>
--

**<class-map-name>** is the name of an existing DiffServ class.

**Note:** The class name 'default' is reserved and is not allowed here. This command may be issued at any time; if the class is currently referenced by one or more policies or by any other class, this deletion attempt shall fail.

**Command Mode**  
Global Config

#### 6.18.2.3 class-map rename

This command changes the name of a DiffServ class.

<b>Syntax</b>
---------------

<b>class-map rename &lt;class-map-name&gt; &lt;new-class-map-name&gt;</b>
---

**<class-map-name>** is the name of an existing DiffServ class.

**<new-class-map-name>** is a case-sensitive alphanumeric string from 1 to 31 characters uniquely identifying the class.

**Note:** The class name 'default' is reserved and must not be used here.

**Default**

None

**Command Mode**

Global Config

#### 6.18.2.4 match any

This command adds to the specified class definition a match condition whereby all packets are considered to belong to the class.

**Syntax**

```
match any
```

**Default**

None

**Command Mode**

Class-Map Config

#### 6.18.2.5 match class-map

This command adds to the specified class definition the set of match conditions defined for another class.

**Syntax**

```
match class-map <refclassname>
```

**<refclassname>** is the name of an existing DiffServ class whose match conditions are being referenced by the specified class definition.

**Note:** There is no [not] option for this match command.

**Default**

None

**Command Mode**

Class-Map Config



**Restrictions** The class types of both `<classname>` and `<refclassname>` must be identical (that is, any vs. any, or all vs. all). A class type of `acl` is not supported by this command. Cannot specify `<refclassname>` the same as `<classname>` (that is, self-referencing of class name not allowed). At most one other class may be referenced by a class. Any attempt to delete the `<refclassname>` class while still referenced by any `<classname>` shall fail.

The combined match criteria of `<classname>` and `<refclassname>` must be an allowed combination based on the class type. Any subsequent changes to the `<refclassname>` class match criteria must maintain this validity, or the change attempt shall fail. The total number of class rules formed by the complete reference class chain (includes both predecessor and successor classes) must not exceed a platform-specific maximum. In some cases, each removal of a `refclass` rule reduces the maximum number of available rules in the class definition by one.

#### 6.18.2.6 no match class-map

This command removes from the specified class definition the set of match conditions defined for another class.

<b>Syntax</b>
---------------

<code>no match class-map &lt;refclassname&gt;</code>
--

`<refclassname>` is the name of an existing DiffServ class whose match conditions are being referenced by the specified class definition.

**Note:** There is no `[not]` option for this match command.

**Default**

None

**Command Mode**

Class-Map Config

#### 6.18.2.7 match cos

This command adds to the specified class definition a match condition for the Class of Service value (the only tag in a single tagged packet or the first or outer 802.1Q tag of a double VLAN tagged packet). The value may be from 0 to 7.

**NOTE:** This command is not available on the Broadcom 5630x platform.

**Syntax**

```
match cos <0-7>
```

**Default Setting**

None

**Command Mode**

Class-Map Config

**6.18.2.8 match destination-address mac**

This command adds to the specified class definition a match condition based on the destination MAC address of a packet. The <address> parameter is any layer 2 MAC address formatted as six, two-digit hexadecimal numbers separated by colons (e.g., 00:11:22:dd:ee:ff). The <mac-mask> parameter is a layer 2 MAC address bit mask, which need not be contiguous, and is formatted as six, two-digit hexadecimal numbers separated by colons (e.g., ff:07:23:ff:fe:dc).

**NOTE:** This command is not available on the Broadcom 5630x platform.

**Syntax**

```
match destination-address mac <address> <mac-mask>
```

<address> - Specifies any layer 2 MAC address.

<mac-mask> - Specifies a layer 2 MAC address bit mask.

**Default Setting**

None

**Command Mode**

Class-Map Config

**6.18.2.9 match dstip**

This command adds to the specified class definition a match condition based on the

destination IP address of a packet.

**Syntax**

```
match dstip <ipaddr> <ipmask>
```

**<ipaddr>** specifies an IP address.

**<ipmask>** specifies an IP address bit mask; note that although similar to a standard subnet mask, this bit mask need not be contiguous.

**Default**

None

**Command Mode**

Class-Map Config

### 6.18.2.10 match dstl4port

This command adds to the specified class definition a match condition based on the destination layer 4 port of a packet using a single keyword or numeric notation or a numeric range notation.

**Syntax**

```
match dstl4port {<portkey> | <0-65535>}
```

To specify the match condition as a single keyword, the value for **<portkey>** is one of the supported port name keywords. The currently supported **<portkey>** values are: **domain, echo, ftp, ftpdata, http, smtp, snmp, telnet, tftp, www**. Each of these translates into its equivalent port number, which is used as both the start and end of a port range.

To specify the match condition using a numeric notation, one layer 4 port number is required.

The port number is an integer from 0 to 65535.

To specify the match condition using a numeric range notation, two layer 4 port numbers are required and together they specify a contiguous port range. Each port number is an integer from 0 to 65535, but with the added requirement that the second number be equal to or greater than the first.

**Default**

None

**Command Mode**

Class-Map Config

### 6.18.2.11 match ethertype

This command adds to the specified class definition a match condition based on the value of the ethertype. The <ethertype> value is specified as one of the following keywords: **appletalk**, **arp**, **ibmsna**, **ipv4**, **ipv6**, **ipx**, **mplsmcast**, **mplsucast**, **netbios**, **novell**, **pppoe**, **rarp** or as a custom ethertype value in the range of 0x0600-0xFFFF.

**NOTE:** This command is not available on the Broadcom 5630x platform.

#### Syntax

```
match ethertype {<keyword> | <0x0600-0xFFFF>}
```

<keyword> - Specifies **appletalk**, **arp**, **ibmsna**, **ipv4**, **ipv6**, **ipx**, **mplsmcast** etc  
<0x0600-0xFFFF> - Specifies ethertype value.

#### Default Setting

None

#### Command Mode

Class-Map Config

### 6.18.2.12 match ip dscp

This command adds to the specified class definition a match condition based on the value of the IP DiffServ Code Point (DSCP) field in a packet, which is defined as the high-order six bits of the Service Type octet in the IP header (the low-order two bits are not checked).

#### Syntax

```
match ip dscp <value>
```

<dscpval> value is specified as either an integer from 0 to 63, or symbolically through one of the following keywords: **af11**, **af12**, **af13**, **af21**, **af22**, **af23**, **af31**, **af32**, **af33**, **af41**, **af42**, **af43**, **be**, **cs0**, **cs1**, **cs2**, **cs3**, **cs4**, **cs5**, **cs6**, **cs7**, **ef**.

**Note:** The ip dscp, ip precedence, and ip tos match conditions are alternative ways to specify a match criterion for the same Service Type field in the IP header, but with a slightly different

user notation.

**Note:** To specify a match on all DSCP values, use the match [not] ip tos <tosbits> <tosmask> command with <tosbits> set to 0 and <tosmask> set to 03 (hex).

**Default**

None

**Command Mode**

Class-Map Config

### 6.18.2.13 match ip precedence

This command adds to the specified class definition a match condition based on the value of the IP Precedence field in a packet, which is defined as the high-order three bits of the Service Type octet in the IP header (the low-order five bits are not checked). The precedence value is an integer from 0 to 7.

**Syntax**

```
match ip precedence <0-7>
```

**Note:** The ip dscp, ip precedence, and ip tos match conditions are alternative ways to specify a match criterion for the same Service Type field in the IP header, but with a slightly different user notation.

**Note:** To specify a match on all Precedence values, use the match [not] ip tos <tosbits> <tosmask> command with <tosbits> set to 0 and <tosmask> set to 1F (hex).

**Default**

None

**Command Mode**

Class-Map Config

### 6.18.2.14 match ip tos

This command adds to the specified class definition a match condition based on the value of the IP TOS field in a packet, which is defined as all eight bits of the Service Type octet in the IP header.

**Syntax**

```
match ip tos <tosbits> <tosmask>
```

<tosbits> is a two-digit hexadecimal number from 00 to ff.

<tosmask> is a two-digit hexadecimal number from 00 to ff.

The <tosmask> denotes the bit positions in <tosbits> that are used for comparison against the IP TOS field in a packet. For example, to check for an IP TOS value having bits 7 and 5 set and bit 1 clear, where bit 7 is most significant, use a <tosbits> value of a0 (hex) and a <tosmask> of a2 (hex).

**Note:** The ip dscp, ip precedence, and ip tos match conditions are alternative ways to specify a match criterion for the same Service Type field in the IP header, but with a slightly different user notation.

**Note:** In essence, this the “free form” version of the IP DSCP/Precedence/TOS match specification in that the user has complete control of specifying which bits of the IP Service Type field are checked.

**Default**

None

**Command Mode**

Class-Map Config

### 6.18.2.15 match protocol

This command adds to the specified class definition a match condition based on the value of the IP Protocol field in a packet using a single keyword notation or a numeric value notation.

**Syntax**

```
match protocol {<protocol-name> | <0-255>}
```

<protocol-name> is one of the supported protocol name keywords. The currently supported values are: **icmp**, **igmp**, **ip**, **tcp**, **udp**. Note that a value of **ip** is interpreted to match all protocol number values. To specify the match condition using a numeric value notation, the protocol number is a standard value assigned by IANA and is interpreted as an integer from 0 to 255.

**Note:** This command does not validate the protocol number value against the current list defined by IANA.

**Default**

None

**Command Mode**

## Class-Map Config

**6.18.2.16 match secondary-cos**

This command adds to the specified class definition a match condition for the secondary Class of Service value (the inner 802.1Q tag of a double VLAN tagged packet). The value may be from 0 to 7.

**NOTE:** This command is not available on the Broadcom 5630x platform.

**Syntax**

```
match secondary-cos <0-7>
```

**Default Setting**

None

**Command Mode**

Class-Map Config

**6.18.2.17 match secondary-vlan**

This command adds to the specified class definition a match condition based on the value of the layer 2 secondary VLAN Identifier field (the inner 802.1Q tag of a double VLAN tagged packet). The secondary VLAN ID is an integer from 1 to 4095.

**NOTE:** This command is not available on the Broadcom 5630x platform.

**Syntax**

```
match secondary-vlan <0-4095>
```

**Default Setting**

None

**Command Mode**

Class-Map Config

### 6.18.2.18 match source-address mac

This command adds to the specified class definition a match condition based on the source MAC address of a packet. The <address> parameter is any layer 2 MAC address formatted as six, two-digit hexadecimal numbers separated by colons (e.g., 00:11:22:dd:ee:ff). The <macmask> parameter is a layer 2 MAC address bit mask, which may not be contiguous, and is formatted as six, two-digit hexadecimal numbers separated by colons (e.g., ff:07:23:ff:fe:dc).

**NOTE:** This command is not available on the Broadcom 5630x platform.

<b>Syntax</b>
---------------

<b>match source-address mac &lt;address&gt; &lt;macmask&gt;</b>
---

<address> - Specifies any layer 2 MAC address.

<macmask> - Specifies a layer 2 MAC address bit mask.

#### Default Setting

None

#### Command Mode

Class-Map Config

### 6.18.2.19 match srcip

This command adds to the specified class definition a match condition based on the source IP address of a packet.

<b>Syntax</b>
---------------

<b>match srcip &lt;ipaddr&gt; &lt;ipmask&gt;</b>
--

<ipaddr> specifies an IP address.

<ipmask> specifies an IP address bit mask; note that although it resembles a standard subnet mask, this bit mask need not be contiguous.

#### Default



None

**Command Mode**

Class-Map Config

**6.18.2.20 match srcl4port**

This command adds to the specified class definition a match condition based on the source layer 4 port of a packet using a single keyword or numeric notation or a numeric range notation.

**Syntax**

```
match srcl4port {<portkey> | <0-65535>}
```

**<portkey>** is one of the supported port name keywords (listed below).

The currently supported **<portkey>** values are: domain, echo, ftp, ftpdata, http, smtp, snmp, telnet, tftp, www. Each of these translates into its equivalent port number, which is used as both the start and end of a port range.

To specify the match condition as a numeric value, one layer 4 port number is required. The port number is an integer from 0 to 65535.

To specify the match condition as a range, two layer 4 port numbers are required and together they specify a contiguous port range. Each port number is an integer from 0 to 65535, but with the added requirement that the second number be equal to or greater than the first.

**Default**

None

**Command Mode**

Class-Map Config

**6.18.2.21 match vlan**

This command adds to the specified class definition a match condition based on the value of the layer 2 VLAN Identifier field (the only tag in a single tagged packet or the first or outer tag of a double VLAN tagged packet). The VLAN ID is an integer from 1 to 4095.

**NOTE:** This command is not available on the Broadcom 5630x platform.

**Syntax**

```
match vlan <1-4095>
```

**Default Setting**

None

**Command Mode**

Class-Map Config

### 6.18.3 Policy Commands

The 'policy' command set is used in DiffServ to define:

**Traffic Conditioning** Specify traffic conditioning actions (policing, marking, shaping) to apply to traffic classes

**Service Provisioning** Specify bandwidth and queue depth management requirements of service levels (EF, AF, etc.)

The policy commands are used to associate a traffic class, which was defined by the class command set, with one or more QoS policy attributes. This association is then assigned to an interface in a particular direction to form a service. The user specifies the policy name when the policy is created.

The DiffServ CLI does not necessarily require that users associate only one traffic class to one policy. In fact, multiple traffic classes can be associated with a single policy, each defining a particular treatment for packets that match the class definition. When a packet satisfies the conditions of more than one class, preference is based on the order in which the classes were added to the policy, with the foremost class taking highest precedence.

This set of commands consists of policy creation/deletion, class addition/removal, and individual policy attributes. Note that the only way to remove an individual policy attribute from a class instance within a policy is to remove the class instance and re-add it to the policy. The values associated with an existing policy attribute can be changed without removing the class instance.

The CLI command root is ***policy-map***.

#### 6.18.3.1 assign-queue

This command modifies the queue id to which the associated traffic stream is assigned. The queueid is an integer from 0 to n-1, where n is the number of egress queues supported by the

device.

**Syntax**

```
assign-queue <0-6>
```

<0-6> - Queue ID.

**Command Mode**

Policy-Class-Map Config

**6.18.3.2 drop**

This command specifies that all packets for the associated traffic stream are to be dropped at ingress.

**Syntax**

```
drop
```

**Command Mode**

Policy-Class-Map Config

**6.18.3.3 mirror**

This command specifies that all incoming packets for the associated traffic stream are copied to a specific egress interface (physical port or LAG).

**NOTE:** This command is not available on the Broadcom 5630x platform.

**Syntax**

```
mirror <slot/port>
```

<slot/port> - Interface Number.

**Default Setting**

None

**Command Mode**

Policy-Class-Map Config

**6.18.3.4 redirect**

This command specifies that all incoming packets for the associated traffic stream are redirected to a specific egress interface (physical port or port-channel).

**Syntax**

```
redirect <slot/port>
```

**Command Mode**

Policy-Class-Map Config

**6.18.3.5 conform-color**

This command is used to enable color-aware traffic policing and define the conform-color class maps used. Used in conjunction with the police command where the fields for the conform level (for simple, single-rate, and two-rate policing) are specified. The <class-map-name> parameter is the name of an existing Diffserv class map, where different ones must be used for the conform and exceed colors.

**Syntax**

```
conform-color <class-map-name>
```

**<class-map-name>** - Name of an existing Diffserv class map, where different ones must be used for the conform colors.

**Command Mode**

Policy-Class-Map Config

**6.18.3.6 mark cos**

This command marks all packets for the associated traffic stream with the specified class of service value in the priority field of the 802.1p header. If the packet does not already contain this header, one is inserted. The CoS value is an integer from 0 to 7.

**Syntax**

```
mark cos <0-7>
```

**<0-7>** - The range of COS value is 0 to 7.

**Command Mode**

Policy-Class-Map Config

**Policy Type**

In

**6.18.3.7 class**

This command creates an instance of a class definition within the specified policy for the purpose of defining treatment of the traffic class through subsequent policy attribute statements.

**Syntax**

```
class <classname>
```

<*classname*> is the name of an existing DiffServ class. Note that this command causes the specified policy to create a reference to the class definition.

**Command Mode**

Policy-Class-Map Config

**6.18.3.8 no class**

This command deletes the instance of a particular class and its defined treatment from the specified policy.

**Syntax**

```
no class <classname>
```

<*classname*> is the name of an existing DiffServ class. Note that this command removes the reference to the class definition for the specified policy.

**Command Mode**

Policy-Class-Map Config

**6.18.3.9 mark ip-dscp**

This command marks all packets for the associated traffic stream with the specified IP DSCP value.

**Syntax**

```
mark ip-dscp <value>
```

<*value*> is specified as either an integer from 0 to 63, or symbolically through one of the following keywords: *af11*, *af12*, *af13*, *af21*, *af22*, *af23*, *af31*, *af32*, *af33*, *af41*, *af42*, *af43*, *be*, *cs0*, *cs1*, *cs2*, *cs3*, *cs4*, *cs5*, *cs6*, *cs7*, *ef*.

**Command Mode**

Policy-Class-Map Config

**Policy Type In****Incompatibilities** Mark IP Precedence, Police (all forms)

### 6.18.3.10 mark ip-precedence

This command marks all packets for the associated traffic stream with the specified IP Precedence value. The IP Precedence value is an integer from 0 to 7.

<b>Syntax</b>
---------------

<b>mark ip-precedence &lt;0-7&gt;</b>
---------------------------------------

**Command Mode**

Policy-Class-Map Config

**Policy Type In**

**Incompatibilities** Mark IP DSCP, Police (all forms)

### 6.18.3.11 police-simple

This command is used to establish the traffic policing style for the specified class. The simple form of the police command uses a single data rate and burst size, resulting in two outcomes: conform and violate. The conforming data rate is specified in kilobits-per-second (Kbps) and is an integer from 1 to 4294967295. The conforming burst size is specified in kilobytes (KB) and is an integer from 1 to 128.

For each outcome, the only possible actions are drop, set-cos-transmit, set-dscp-transmit, setprec-transmit, or transmit. In this simple form of the police command, the conform action defaults to transmit and the violate action defaults to drop.

For set-dscp-transmit, a <dscpval> value is required and is specified as either an integer from 0 to 63, or symbolically through one of the following keywords: af11, af12, af13, af21, af22, af23, af31, af32, af33, af41, af42, af43, be, cs0, cs1, cs2, cs3, cs4, cs5, cs6, cs7, ef.

For set-prec-transmit, an IP Precedence value is required and is specified as an integer from 0-7.

For set-cos-transmit an 802.1p priority value is required and is specified as an integer from 0-7.

<b>Syntax</b>
---------------

<b>police-simple {&lt;1-4294967295&gt; &lt;1-128&gt; conform-action {drop   set-prec-transmit &lt;0-7&gt;   set-dscp-transmit &lt;0-63&gt;   set-cos-transmit &lt;0-7&gt;   transmit} [violate-action {drop   set-pretransmit &lt;0-7&gt;   set-dscp-transmit &lt;0-63&gt;   set-cos-transmit &lt;0- 7&gt;   transmit}]}</b>
--

The simple form of the police command uses a single data rate and burst size, resulting in two outcomes:

**<conform-action & violate-action>** The conforming data rate is specified in kilobits-per-second (Kbps) and is an integer from 1 to 4294967295. The conforming burst size is specified in kilobytes (KB) and is an integer from 1 to 128. For each outcome, the only possible actions are drop, set-dscp-transmit, set-prec-transmit, or set-cos-transmit. In this simple form of the police command, the conform action defaults to transmit and the violate

action defaults to drop. These actions can be set with this command once the style has been configured. Beside, the set-cos-transmit is to combine only with drop between the conform-action and the violate-action.

**<set-cos-transmit>**, an priority value is required and is specified as an integer from 0-7.

**<set-dscp-transmit>** is required and is specified as either an integer from 0 to 63, or symbolically through one of the following keywords: **af11, af12, af13, af21, af22, af23, af31, af32, af33, af41, af42, af43, be, cs0, cs1, cs2, cs3, cs4, cs5, cs6, cs7, ef.**

**<set-prec-transmit>**, an IP Precedence value is required and is specified as an integer from 0-7.

### Command Mode

Policy-Class-Map Config

**Incompatibilities** Drop, Mark(all forms)

### 6.18.3.12 policy-map

This command establishes a new DiffServ policy. The <policyname> parameter is a case-sensitive alphanumeric string from 1 to 31 characters uniquely identifying the policy. The type of policy is specific to the inbound traffic direction as indicated by the in parameter.

#### Syntax

```
policy-map <policyname> [ in ]
no policy-map <policyname>
```

### Command Mode

Global Config

**Policy Type** In

### 6.18.3.13 policy-map rename

This command changes the name of a DiffServ policy. The <policyname> is the name of an existing DiffServ class. The <newpolicyname> parameter is a case-sensitive alphanumeric string from 1 to 31 characters uniquely identifying the policy.

#### Syntax

```
policy-map rename <policyname> <newpolicyname>
```



<policyname> - Old Policy name.  
<newpolicyname> - New policy name.

**Command Mode**

Global Config

**Policy Type In****6.18.4 Service Commands**

The 'service' command set is used in DiffServ to define:

- Traffic Conditioning** Assign a DiffServ traffic conditioning policy (as specified by the policy commands) to an interface in the incoming direction.
- Service Provisioning** Assign a DiffServ service provisioning policy (as specified by the policy commands) to an interface in the outgoing direction

The service commands attach a defined policy to a directional interface. Only one policy may be assigned at any one time to an interface in a particular direction. The policy type (in, out) must match the interface direction to which it is attached.

This set of commands consists of service addition/removal.

The CLI command root is **service-policy**

**6.18.4.1 service-policy**

This command attaches a policy to an interface in a particular direction.

<b>Syntax</b>
---------------

<b>service-policy in &lt;policy-map-name&gt;</b>
--

The command can be used in the **Interface Config** mode to attach a policy to a specific interface. Alternatively, the command can be used in the **Global Config** mode to attach this policy to all system interfaces. The direction value is either in or out.

<policy-map-name> is the name of an existing DiffServ policy, whose type must match the interface direction. Note that this command causes a service to create a reference to the policy.

**Note:** This command effectively enables DiffServ on an interface (in a particular direction). There is no separate interface administrative 'mode' command for DiffServ.

**Note:** This command shall fail if any attributes within the policy definition exceed the capabilities of the interface. Once a policy is successfully attached to an interface, any attempt to change the policy definition such that it would result in a violation of said interface capabilities shall cause the policy change attempt to fail.

### Command Mode

Global Config (for all system interfaces)  
Interface Config (for a specific interface)

**Restrictions** Only a single policy may be attached to a particular interface in a particular direction at any one time.

#### 6.18.4.2 no service-policy

This command detaches a policy from an interface in a particular direction.

<b>Syntax</b>
---------------

<b>no service-policy in &lt;policy-map-name&gt;</b>
---

The command can be used in the Interface Config mode to detach a policy from a specific interface. Alternatively, the command can be used in the Global Config mode to detach this policy from all system interfaces to which it is currently attached. The direction value is either in or out.

**<policy-map-name>** is the name of an existing DiffServ policy. Note that this command causes a service to remove its reference to the policy.

**Note:** This command effectively disables DiffServ on an interface (in a particular direction). There is no separate interface administrative 'mode' command for DiffServ.

### Command Mode

Global Config (for all system interfaces)  
Interface Config (for a specific interface)

#### 6.18.5 Show Commands

The 'show' command set is used in DiffServ to display configuration and status

information for:

- Classes
- Policies
- Services

This information can be displayed in either summary or detailed formats. The status information is only shown when the DiffServ administrative mode is enabled; it is suppressed otherwise. There is also a 'show' command for general DiffServ information that is available at any time.

### 6.18.5.1 show class-map

This command displays all configuration information for the specified class.

<b>Syntax</b>
---------------

<b>show class-map [&lt;classname&gt;]</b>
---

<classname> is the name of an existing DiffServ class.

#### Default Setting

None

#### Command Mode

Privileged EXEC and User EXEC

#### Display Message

**Class Name** The name of this class.

**Class Type** The class type (all, any, or acl) indicating how the match criteria are evaluated for this class. A class type of all means every match criterion defined for the class is evaluated simultaneously they must all be true to indicate a class match. For a type of any each match criterion is evaluated sequentially and only one need be true to indicate a class match. Class type acl rules are evaluated in a hybrid manner, with those derived from each ACL Rule grouped and evaluated simultaneously, while each such grouping is evaluated sequentially.

**Match Criteria** The Match Criteria fields will only be displayed if they have been configured. They will be displayed in the order entered by the user. These are evaluated in accordance with the class type. The possible Match Criteria fields are: Class of Service, Destination IP Address, Destination Layer 4 Port, Destination MAC Address, Every, IP DSCP, IP Precedence, IP TOS, Protocol Keyword, Reference Class, Source IP Address, Source Layer 4 Port, Source MAC Address, and VLAN.

**Values** This field displays the values of the Match Criteria.

**Excluded** This field indicates whether this Match Criteria is excluded. If the Class Name is not specified, this command displays a list of all defined DiffServ classes. The following fields are displayed:

**Class Name** The name of this class. (Note that the order in which classes are displayed is not necessarily the same order in which they were created.)

**Class Type** The class type (all, any, or acl) indicating how the match criteria are evaluated for this class. A class type of all means every match criterion defined for the class is evaluated simultaneously they must all be true to indicate a class match. For a type of any each match criterion is evaluated sequentially and only one need be true to indicate a class match. Class type acl rules are evaluated in a hybrid manner, with those derived from each ACL Rule grouped and evaluated simultaneously, while each such grouping is evaluated sequentially.

**ACL Number** The ACL number used to define the class match conditions at the time the class was created. This field is only meaningful if the class type is acl. (Note that the contents of the ACL may have changed since this class was created.)

**Ref Class Name** The name of an existing DiffServ class whose match conditions are being referenced by the specified class definition.

#### 6.18.5.2 show diffserv

This command displays the DiffServ General Status Group information, which includes the current administrative mode setting as well as the current and maximum number of rows in each of the main DiffServ private MIB tables.

<b>Syntax</b>
---------------

<code>show diffserv</code>
----------------------------

#### Default Setting

None

#### Command Mode

Privileged EXEC and User EXEC

#### Display Message

**DiffServ Admin mode** The current value of the DiffServ administrative mode.

**Class Table Size Current/Max** The current or maximum number of entries (rows) in the Class Table.

**Class Rule Table Size Current/Max** The current or maximum number of entries (rows) in the Class Rule Table.

**Policy Table Size Current/Max** The current or maximum number of entries (rows) in the

Policy Table.

**Policy Instance Table Size Current/Max** The current or maximum number of entries (rows) in the Policy Instance Table.

**Policy Attribute Table Size Current/Max** The current or maximum number of entries (rows) in the Policy Attribute Table.

**Service Table Size Current/Max** The current or maximum number of entries (rows) in the Service Table.

### 6.18.5.3 show diffserv service

This command displays policy service information for the specified interface and direction.

#### Syntax

```
show diffserv service <slot/port> in
```

<slot/port> specifies a valid slot number and port number for the system. The direction parameter indicates the interface direction of interest.

#### Default Setting

None

#### Command Mode

Privileged EXEC

#### Display Message

**DiffServ Admin Mode** The current setting of the DiffServ administrative mode. An attached policy is only in effect on an interface while DiffServ is in an enabled mode.

**Interface** The slot number and port number of the interface (slot/port).

**Direction** The traffic direction of this interface service.

**Operational Status** The current operational status of this DiffServ service interface.

**Policy Name** The name of the policy attached to the interface in the indicated direction.

**Policy Details** Attached policy details, whose content is identical to that described for the show policy-map <polycymapname> command (content not repeated here for brevity).

### 6.18.5.4 show diffserv service brief

This command displays all interfaces in the system to which a DiffServ policy has been attached. The direction parameter is optional; if specified, only services in the indicated direction are shown.

**Syntax**

```
show diffserv service brief [ in ]
```

**Default Setting**

None

**Command Mode**

Privileged EXEC

**Display Message**

**DiffServ Admin Mode** The current setting of the DiffServ administrative mode. An attached policy is only active on an interface while DiffServ is in an enabled mode.

**The following information is repeated for interface and direction (only those interfaces configured with an attached policy are shown):**

**Interface** The slot number and port number of the interface (slot/port).

**Direction** The traffic direction of this interface service.

**OperStatus** The current operational status of this DiffServ service interface.

**Policy Name** The name of the policy attached to the interface in the indicated direction.

### 6.18.5.5 show policy-map

This command displays all configuration information for the specified policy.

**Syntax**

```
show policy-map [<policy-map-name>]
```

**<policy-map-name>** is the name of an existing DiffServ policy.

**Default Setting**

None

**Command Mode**

Privileged EXEC

**Display Message**

**Policy Name** The name of this policy.

**Policy Type** The policy type, namely whether it is an inbound or outbound policy definition.

**The following information is repeated for each class associated with this policy**

**(only those policy attributes actually configured are displayed):**

**Class Name** The name of this class.

**Mark CoS** Denotes the class of service value that is set in the 802.1p header of outbound packets. This is not displayed if the mark cos was not specified.

**Mark IP DSCP** Denotes the mark/re-mark value used as the DSCP for traffic matching this class. This is not displayed if mark ip description is not specified using the police-two-rate command, or if policing is in use for the class under this policy.

**Mark IP Precedence** Denotes the mark/re-mark value used as the IP Precedence for traffic matching this class. This is not displayed if either mark DSCP or policing is in use for the class under this policy.

**Policing Style** This field denotes the style of policing, if any, used simple.

**Committed Rate (Kbps)** This field displays the committed rate, used in simple policing, single-rate policing, and two-rate policing.

**Committed Burst Size (KB)** This field displays the committed burst size, used in simple policing.

**Conform Action** The current setting for the action taken on a packet considered to conform to the policing parameters. This is not displayed if policing is not in use for the class under this policy.

**Conform COS Value** This field shows the priority mark value if the conform action is markcos.

**Conform DSCP Value** This field shows the DSCP mark value if the conform action is markdscp.

**Conform IP Precedence Value** This field shows the IP Precedence mark value if the conform action is markprec.

**Non-Conform Action** The current setting for the action taken on a packet considered to not conform to the policing parameters. This is not displayed if policing not in use for the class under this policy.

**Non-Conform DSCP Value** This field displays the DSCP mark value if this action is markdscp.

**Non-Conform IP Precedence Value** This field displays the IP Precedence mark value if this action is markprec.

**Bandwidth** This field displays the minimum amount of bandwidth reserved in either percent or kilobits-per-second.

**Policy Name** The name of this policy. (Note that the order in which the policies are displayed is not necessarily the same order in which they were created.)

**Policy Type** The policy type, namely whether it is an inbound or outbound policy definition.

**Class Members** List of all class names associated with this policy.

#### 6.18.5.6 show policy-map interface

This command displays policy-oriented statistics information for the specified interface and direction.

**Syntax**

**show policy-map interface <slot/port> in**

<slot/port> specifies a valid slot number and port number for the system. The direction parameter indicates the interface direction of interest.

**Command Mode**

Privileged EXEC

**Display Message**

**Interface** The slot number and port number of the interface (slot/port).

**Direction** The traffic direction of this interface service, either in or out.

**Operational Status** The current operational status of this DiffServ service interface.

**Policy Name** The name of the policy attached to the interface in the indicated direction.

**Interface Offered Octets/Packets** A cumulative count of the octets/packets offered to this service interface in the specified direction before the defined DiffServ treatment is applied.

**Interface Discarded Octets/Packets** A cumulative count of the octets/packets discarded by this service interface in the specified direction for any reason due to DiffServ treatment.

**Interface Sent Octets/Packets** A cumulative count of the octets/packets forwarded by this service interface in the specified direction after the defined DiffServ treatment was applied. In this case, forwarding means the traffic stream was passed to the next functional element in the data path, such as the switching or routing function or an outbound link transmission element.

**The following information is repeated for each class instance within this policy:**

**Class Name** The name of this class instance.

**In Offered Octets/Packets** A count of the octets/packets offered to this class instance before the defined DiffServ treatment is applied. Only displayed for the 'in' direction.

**In Discarded Octets/Packets** A count of the octets/packets discarded for this class instance for any reason due to DiffServ treatment of the traffic class. Only displayed for the 'in' direction.

**Tail Dropped Octets/Packets** A count of the octets/packets discarded due to tail dropping from a transmission queue, typically due to the effects of traffic shaping. These counts may not be supported on all platforms. Only displayed for the 'out' direction.

**Random Dropped Octets/Packets** A count of the octets/packets discarded due to WRED active queue depth management, typically due to the effects of traffic shaping. These counts are only applicable for a class instance whose policy attributes includes random dropping, and may not be supported on all platforms. Only displayed for the 'out' direction.

**Shape Delayed Octets/Packets** A count of the octets/packets that were delayed due to traffic shaping. These counts are only applicable for a class instance whose policy attributes includes shaping, and may not be supported on all platforms. Only displayed for the 'out' direction.



**Sent Octets/Packets** A count of the octets/packets forwarded for this class instance after the defined DiffServ treatment was applied. In this case, forwarding means the traffic stream was passed to the next functional element in the data path, such as the switching or routing function or an outbound link transmission element. Only displayed for the 'out' direction.

**Note:** None of the counters listed here are guaranteed to be supported on all platforms. Only supported counters are shown in the display output.

### 6.18.5.7 show service-policy

This command displays a summary of policy-oriented statistics information for all interfaces in the specified direction. The direction parameter indicates the interface direction of interest. This command enables or disables the route reflector client. A route reflector client relies on a route reflector to re-advertise its routes to the entire AS. The possible values for this field are **enable** and **disable**.

<b>Syntax</b>
---------------

<b>show service-policy [in]</b>
---------------------------------

#### Command Mode

Privileged EXEC

#### Display Message

The following information is repeated for each interface and direction (only those interfaces configured with an attached policy are shown):

**Interface** The slot number and port number of the interface (slot/port).

**Operational Status** The current operational status of this DiffServ service interface.

**Policy Name** The name of the policy attached to the interface.

**Note:** None of the counters listed here are guaranteed to be supported on all platforms. Only supported counters are shown in the display output.

## 6.19 ACL Command

## 6.19.1 Show Commands

### 6.19.1.1 show mac access-lists name

This command displays a MAC access list and all of the rules that are defined for the ACL. The <name> parameter is used to identify a specific MAC ACL to display.

<b>Syntax</b>
---------------

<b>show mac access-lists &lt;name&gt;</b>
---

<name> ACL name which uniquely identifies the MAC ACL to display.

#### Default Setting

None

#### Command Mode

Privileged EXEC

#### Display Message

**MAC ACL Name** The name of the MAC ACL rule.

**Rule Number** The ordered rule number identifier defined within the ACL.

**Action** Displays the action associated with each rule. The possible values are Permit or Deny.

**Source MAC Address** Displays the source MAC address for this rule.

**Source MAC Mask** Displays the source MAC mask for this rule.

**Destination MAC Address** Displays the destination MAC address for this rule.

**Destination MAC Mask** Displays the destination MAC mask for this rule.

**Ethertype** Displays the Ethertype keyword or custom value for this rule.

**VLAN ID** Displays the VLAN identifier value or range for this rule.

**CoS Value** Displays the COS (802.1p) value for this rule.

**Secondary VLAN ID** Displays the Secondary VLAN identifier value or range for this rule.

**Secondary COS** Displays the Secondary COS (802.1p) value for this rule.

**Assign Queue** Displays the queue identifier to which packets matching this rule are assigned.

**Redirect Interface** Displays the slot/port to which packets matching this rule are forwarded.

### 6.19.1.2 show mac access-lists

This command displays a summary of all defined MAC access lists in the system.

**Syntax**

```
show mac access-lists
```

**Default Setting**

None

**Command Mode**

Privileged EXEC

**Display Message**

**Current number of all ACLs** The number of user-configured rules defined for this ACL.

**Maximum number of all ACLs** The maximum number of ACL rules.

**MAC ACL Name** The name of the MAC ACL rule.

**Rules** The number of rule in this ACL.

**Direction** Denotes the direction in which this MAC ACL is attached to the set of interfaces listed. The possible values are Inbound or Outbound.

**Interfaces** Displays the list of interfaces (slot/port) to which this MAC ACL is attached in a given direction.

**6.19.1.3 show ip access-lists**

This command displays an Access Control List (ACL) and all of the rules that are defined for the ACL.

**Syntax**

```
show ip access-lists [<1-199>]
```

<1-199> is the number used to identify the ACL.

**Default Setting**

None

**Command Mode**

Privileged EXEC

**Display Message**

**Current number of ACLs** The number of user-configured rules defined for this ACL.

**Maximum number of ACLs** The maximum number of ACL rules.

**ACL ID** The identifier of this ACL.

**Rule** This displays the number identifier for each rule that is defined for the ACL.

**Action** This displays the action associated with each rule. The possible values are Permit or Deny.

**Match ALL** Match all packets or not.

**Protocol** This displays the protocol to filter for this rule.

**Source IP Address** This displays the source IP address for this rule.

**Source IP Mask** This field displays the source IP Mask for this rule.

**Source Ports** This field displays the source port range for this rule.

**Destination IP Address** This displays the destination IP address for this rule.

**Destination IP Mask** This field displays the destination IP Mask for this rule.

**Destination Ports** This field displays the destination port range for this rule.

**Service Type Field Match** This field indicates whether an IP DSCP, IP Precedence, or IP TOS match condition is specified for this rule.

**Service Type Field Value** This field indicates the value specified for the Service Type Field Match (IP DSCP, IP Precedence, or IP TOS).

#### 6.19.1.4 show access-lists interface

This command displays Access List information for a particular interface and the 'in' direction.

##### Syntax

```
show access-lists { interface <slot/port> | vlan <vlan id> } in
```

<slot/port> is the interface number.

##### Default Setting

None

##### Command Mode

Privileged EXEC

##### Display Message

**ACL Type:** This displays ACL type is IP, IPv6 or MAC.

**ACL ID:** Access List name for a MAC or IPv6 access list or the numeric identifier for an IP access list.

**Sequence Number:** An optional sequence number may be specified to indicate the order of this access list relative to other access lists already assigned to this interface and direction. A lower number indicates higher precedence order. If a sequence number is already in use for this interface and direction, the specified access list replaces the currently attached access list using that sequence number. If the sequence number is not specified by the user, a sequence number that is one greater than the highest sequence number currently in use for

this interface and direction is used. Valid range is (1 to 4294967295).

## 6.19.2 Configuration Commands

### 6.19.2.1 mac access-list extended

This command creates a MAC Access Control List (ACL) identified by <name>, consisting of classification fields defined for the Layer 2 header of an Ethernet frame. The <name> parameter is a case-sensitive alphanumeric string from 1 to 31 characters uniquely identifying the MAC access list. If a MAC ACL by this name already exists, this command enters Mac-Access-List config mode to allow updating the existing ACL.

#### Syntax

```
mac access-list extended <name>  
no mac access-list extended <name>
```

<name> - It uniquely identifies the MAC access list.

#### Default Setting

None

#### Command Mode

Global Config

### 6.19.2.2 mac access-list extended rename

This command changes the name of a MAC Access Control List (ACL). The <name> parameter is the name of an existing MAC ACL. The <newname> parameter is a case-sensitive alphanumeric string from 1 to 31 characters uniquely identifying the MAC access list. This command fails if a MAC ACL by the name <newname> already exists.

#### Syntax

```
mac access-list extended rename <oldname> <newname>
```

**<oldname>** - Old name which uniquely identifies the MAC access list.

**<newname>** - New name which uniquely identifies the MAC access list.

**Default Setting**

None

**Command Mode**

Global Config

**6.19.2.3 mac access-group in**

This command attaches a specific MAC Access Control List (ACL) identified by <name> to an interface in a given direction. The <name> parameter must be the name of an existing MAC ACL. An optional sequence number may be specified to indicate the order of this access list relative to other access lists already assigned to this interface and direction. A lower number indicates higher precedence order. If a sequence number is already in use for this interface and direction, the specified access list replaces the currently attached access list using that sequence number. If the sequence number is not specified for this command, a sequence number that is one greater than the highest sequence number currently in use for this interface and direction will be used. This command specified in 'Interface Config' mode only affects a single interface, whereas the 'Global Config' mode setting is applied to all interfaces. The 'Interface Config' mode command is only available on platforms that support independent per-port class of service queue configuration.

**Syntax**

```
mac access-group <name> in [<1-4294967295>]
```

```
no mac access-group <name> in
```

**<no>** - This command removes a MAC ACL identified by <name> from the interface in a given direction.

**Default Setting**

None

**Command Mode**

Global Config, Interface Config

### 6.19.2.4 mac access-list

This command creates a new rule for the current MAC access list. Each rule is appended to the list of configured rules for the list. Note that an implicit 'deny all' MAC rule always terminates the access list. Note: The 'no' form of this command is not supported, as the rules within an ACL cannot be deleted individually. Rather, the entire ACL must be deleted and re-specified.

A rule may either deny or permit traffic according to the specified classification fields. At a minimum, the source and destination MAC value and mask pairs must be specified, each of which may be substituted using the keyword any to indicate a match on any value in that field. The bpdud keyword may be specified for the destination MAC value/mask pair indicating a well-known BPDU MAC value of 01-80-c2-xx-xx-xx (hex), where 'xx' indicates a don't care. The remaining command parameters are all optional. The Ethertype may be specified as either a keyword or a four-digit hexadecimal value from 0x0600-0xFFFF. The currently supported <ethertypekey> values are: appletalk, arp, ibmsna, ipv4, ipv6, ipx, mplsicast, mplsucast, netbios, novell, pppoe, rarp. Each of these translates into its equivalent Ethertype value(s). The assign-queue parameter allows specification of a particular hardware queue for handling traffic that matches this rule. The allowed <queue-id> value is 0-(n-1), where n is the number of user configurable queues available for the hardware platform. The redirect parameter allows the traffic matching this rule to be forwarded to the specified <slot/port>. The assign-queue and redirect parameters are only valid for a 'permit' rule.

#### Syntax

```
{deny | permit} {{<srcmac> <srcmask>} | any} {{<dstmac> <dstmask>} | any | bpdud}
[<ethertypekey> | <0x0600-0xFFFF>] [vlan {{eq <0-4095>}}] [ cos <0-7>]
[<secondary-vlan {{eq <0-4095>}}] [secondary-cos <0-7>] [log] [assign-queue
<queue-id>] [{mirror | redirect} <slot/port>] [<rule-id>]
```

#### Default Setting

None

#### Command Mode

Mac Access-list Config

### 6.19.2.5 access-list

This command creates an Access Control List (ACL) that is identified by the parameter.

**Syntax**

```
access-list {(<1-99> {deny | permit} {every | <srcip> <srcmask>}) | ( {<100-199> {deny | permit} {every | {{icmp | igmp | ip | tcp | udp | <number>} any | <srcip> <srcmask> [{eq {<0-65535> | <portkey>}}] ( any | <dstip> <dstmask> ) [{eq {<0-65535> | <portkey>}}] [[precedence <precedence>] | [tos <tos> <tosmask>] | [dscp <dscp>] [log] [assign-queue <queue-id>] [{mirror | redirect} <slot/port>] [<rule-id>]]}})}
```

**<accesslistnumber>**. The ACL number is an integer from 1 to 199. The range 1 to 99 is for the normal ACL List and 100 to 199 is for the extended ACL List.

**permit or deny**. The ACL rule is created with two options. The protocol to filter for an ACL rule is specified by giving the protocol to be used like **icmp, igmp, ip, tcp, udp**. The command specifies a source ip address and source mask for match condition of the ACL rule specified by the **srcip and srcmask** parameters. The source layer 4 port match condition for the ACL rule is specified by the *port value* parameter.

**<portvalue>** uses a single keyword notation and currently has the values of **domain, echo, ftp, ftpdata, http, smtp, snmp, telnet, tftp**, and **www**. Each of these values translates into its equivalent port number, which is used as both the start and end of a port range. The command specifies a destination ip address and destination mask for match condition of the ACL rule specified by the *dstip* and *dstmask* parameters. The command specifies the TOS for an ACL rule depending on a match of precedence or DSCP values using the parameters **tos, tosmask, dscp**.

**Default Setting**

None

**Command Mode**

Global Config

**6.19.2.6 no access-list**

This command deletes an ACL that is identified by the parameter *<accesslistnumber>* from the system.

**Syntax**

```
no access-list {<1-99> | <100-199>}
```

**Note:** The ACL number is an integer from 1 to 199. The range 1 to 99 is for the normal ACL List and 100 to 199 is for the extended ACL List.



**Default Setting**

None

**Command Mode**

Global Config

**6.19.2.7 ip access-group**

This command attaches a specified access-control list to an interface.

**Syntax**

```
ip access-group <1- 199> in [<1-4294967295>]
```

<1- 199> The identifier of this ACL.

<1-4294967295> The sequence number of this ACL.

**Default Setting**

None

**Command Mode**

Global Config, Interface Config

**6.20 IPv6 ACL Command****6.20.1 Show Commands****6.20.1.1 show ipv6 access-lists**

This command displays an IPv6 access list and all of the rules that are defined for the IPv6 ACL. Use the [name] parameter to identify a specific IPv6 ACL to display.

**Syntax**

```
show ipv6 access-lists [<name>]
```

<name> ACL name which uniquely identifies the IPv6 ACL to display.

### Default Setting

None

### Command Mode

Privileged EXEC  
User EXEC

### Display Message

**Rule Number:** The ordered rule number identifier defined within the IPv6 ACL.

**Action:** The action associated with each rule. The possible values are Permit or Deny.

**Match All:** Indicates whether this access list applies to every packet. Possible values are True or False.

**Protocol:** The protocol to filter for this rule.

**Source IP Address:** The source IP address for this rule.

**Source L4 Port Keyword:** The source port for this rule.

**Destination IP Address:** The destination IP address for this rule.

**Destination L4 Port Keyword:** The destination port for this rule.

**IP DSCP:** The value specified for IP DSCP.

**Flow Label:** The value specified for IPv6 Flow Label.

**Log:** Displays when you enable logging for the rule.

**Assign Queue:** The queue identifier to which packets matching this rule are assigned.

**Mirror Interface:** The slot/port to which packets matching this rule are copied.

**Redirect Interface:** The slot/port to which packets matching this rule are forwarded.

## 6.20.2 Configuration Commands

### 6.20.2.1 ipv6 access-list

This command creates an IPv6 Access Control List (ACL) identified by <name>, consisting of classification fields defined for the IP header of an IPv6 frame. The <name> parameter is a case-sensitive alphanumeric string from 1 to 31 characters uniquely identifying the IPv6 access list.

If an IPv6 ACL by this name already exists, this command enters IPv6-Access-List config mode to allow updating the existing IPv6 ACL.

#### Syntax

```
ipv6 access-list <name>  
no ipv6 access-list <name>
```

**no** - This command deletes the IPv6 ACL identified by <name> from the system.

**Note:** The CLI mode changes to IPv6-Access-List Config mode when you successfully execute

this command.

**Default Setting**

None

**Command Mode**

Global Config

**6.20.2.2 ipv6 access-list rename**

This command changes the name of an IPv6 ACL. The <name> parameter is the name of an existing IPv6 ACL. The <newname> parameter is a case-sensitive alphanumeric string from 1 to 31 characters uniquely identifying the IPv6 access list.

This command fails if an IPv6 ACL by the name <newname> already exists.

**Syntax**

```
ipv6 access-list rename <name> <newname>
```

**Default Setting**

None

**Command Mode**

Global Config

**6.20.2.3 {deny | permit} (IPv6)**

This command creates a new rule for the current IPv6 access list. Each rule is appended to the list of configured rules for the list.

Note: The 'no' form of this command is not supported, since the rules within an IPv6 ACL cannot be deleted individually. Rather, the entire IPv6 ACL must be deleted and respecified.

Note: An implicit 'deny all' IPv6 rule always terminates the access list.

A rule may either deny or permit traffic according to the specified classification fields. At a minimum, either the 'every' keyword or the protocol, source address, and destination address values must be specified. The source and destination IPv6 address fields may be specified using the keyword 'any' to indicate a match on any value in that field. The remaining command parameters are all optional, but the most frequently used parameters appear in the same relative order as shown in the command format.

The assign-queue parameter allows specification of a particular hardware queue for handling traffic that matches this rule. The allowed <queue-id> value is 0-(n-1), where n is the number of user configurable queues available for the hardware platform. The assign-queue parameter is valid only for a permit rule.

The mirror parameter allows the traffic matching this rule to be copied to the specified <slot/port>, while the redirect parameter allows the traffic matching this rule to be forwarded to the specified <slot/port>. The assign-queue and redirect parameters are only valid for a permit rule.

**Syntax**

```
{deny | permit} {every | {log} [assign-queue <queue-id>] [{mirror | redirect}
<slot/port>]
no rule <rule-id>
```

**no** - This command removes an IPv6 ACL rule id

**Default Setting**

None

**Command Mode**

IPv6-Access-List Config

**6.20.2.4 ipv6 traffic-filter**

This command either attaches a specific IPv6 ACL identified by <name> to an interface or associates with a VLAN ID in a given direction. The <name> parameter must be the name of an existing IPv6 ACL.

An optional sequence number may be specified to indicate the order of this mac access list relative to other IPv6 access lists already assigned to this interface and direction. A lower number indicates higher precedence order. If a sequence number is already in use for this interface and direction, the specified IPv6 access list replaces the currently attached IPv6 access list using that sequence number. If the sequence number is not specified for this command, a sequence number that is one greater than the highest sequence number currently in use for this interface and direction is used.

This command specified in Interface Config mode only affects a single interface, whereas the Global Config mode setting is applied to all interfaces. The vlan keyword is only valid in the Global Config mode. The Interface Config mode command is only available on platforms that support independent per-port class of service queue configuration.

**Syntax**

```
ipv6 traffic-filter <name> [vlan <vlan-id>] in [<1-4294967295>]
```

```
no ipv6 traffic-filter <name> [vlan <vlan-id>] in [<1-4294967295>]
```

**no** - This command removes an IPv6 ACL identified by <name> from the interface(s) in a given direction

**Default Setting**

None

**Command Mode**

Global Config  
Interface Config

### 6.20.2.5 ipv6 traffic-filter

This command either attaches a specific IP ACL identified by <accesslistnumber> to an interface or associates with a VLAN ID in a given direction.

An optional sequence number may be specified to indicate the order of this IP access list relative to other IP access lists already assigned to this interface and direction. A lower number indicates higher precedence order. If a sequence number is already in use for this interface and direction, the specified access list replaces the currently attached IP access list using that sequence number. If the sequence number is not specified for this command, a sequence number that is one greater than the highest sequence number currently in use for this interface and direction is used.

**Syntax**

```
ip access-group <accesslistnumber> [vlan <vlan-id>] in [<1-4294967295>]  
no ip access-group <accesslistnumber> [vlan <vlan-id>] in
```

**no** - This command removes a specified IP ACL from an interface.

**Default Setting**

None

**Command Mode**

Global Config

### 6.20.2.6 mac access-group

This command either attaches a specific MAC Access Control List (ACL) identified by <name> to an interface, or associates it with a VLAN ID, in a given direction. The <name> parameter

must be the name of an existing MAC ACL.

An optional sequence number may be specified to indicate the order of this mac access list relative to other mac access lists already assigned to this interface and direction. A lower number indicates higher precedence order. If a sequence number is already in use for this interface and direction, the specified mac access list replaces the currently attached mac access list using that sequence number. If the sequence number is not specified for this command, a sequence number that is one greater than the highest sequence number currently in use for this interface and direction is used.

This command specified in 'Interface Config' mode only affects a single interface, whereas the 'Global Config' mode setting is applied to all interfaces. The VLAN keyword is only valid in the 'Global Config' mode. The 'Interface Config' mode command is only available on platforms that support independent per-port class of service queue configuration.

**Syntax**

```
mac access-group <name> [vlan <vlan-id>] in [<1-4294967295>]
no mac access-group <name> [vlan <vlan-id>] in
```

**no** - This command removes a MAC ACL identified by <name> from the interface in a given direction.

**Default Setting**

None

**Command Mode**

Global Config

Interface Config

## 6.21 CoS (Class of Service) Command

### 6.21.1 Show Commands

#### 6.21.1.1 show queue cos-map

This command displays the current Dot1p (802.1p) priority mapping to internal traffic classes for a specific interface. The slot/port parameter is optional and is only valid on platforms that support independent per-port class of service mappings. If specified, the 802.1p mapping table of the interface is displayed. If omitted, the most recent global configuration settings are displayed.

**Syntax**

```
show queue cos-map <slot/port>
```

< slot/port > The interface number.

**Default Setting**

None

**Command Mode**

Privileged EXEC, User EXEC

**Display Message**

The following information is repeated for each user priority.

**User Priority** The 802.1p user priority value.

**Traffic Class** The traffic class internal queue identifier to which the user priority value is mapped.

**6.21.1.2 show queue ip-dscp-mapping**

This command maps an IP DSCP value to an internal traffic class. The <ipdscp> value is specified as either an integer from 0 to 63, or symbolically through one of the following keywords: af11, af12, af13, af21, af22, af23, af31, af32, af33, af41, af42, af43, be, cs0, cs1, cs2, cs3, cs4, cs5, cs6, cs7, ef.

The <trafficclass> values can range from 0-6, although the actual number of available traffic classes depends on the platform.

**Syntax**

```
show queue ip-dscp-mapping
```

**Default Setting**

None

**Command Mode**

Privileged EXEC

**Display Message**

**IP DSCP:** Displays IP DSCP value.

**Traffic Class:** Displays the queue mapping.

### 6.21.1.3 show queue trust

This command displays the current trust mode setting for a specific interface. The slot/port parameter is optional and is only valid on platforms that support independent per-port class of service mappings. If specified, the port trust mode of the interface is displayed. If omitted, the port trust mode of each interface in the system is shown. If the platform does not support independent per-port class of service mappings, the output represents the system-wide port trust mode used for all interfaces.

<b>Syntax</b>
---------------

<b>show queue trust &lt;slot/port&gt;</b>
---

< slot/port > The interface number.

#### Default Setting

None

#### Command Mode

Privileged EXEC, User EXEC

#### Display Message

**Class of Service Trust Mode** The trust mode of this interface.

**Non-IP Traffic Class** The traffic class used for non-IP traffic. This is only displayed when the COS trust mode is set to either 'trust ip-dscp' or 'trust ip-precedence'.

**Untrusted Traffic Class** The traffic class used for all untrusted traffic. This is only displayed when the COS trust mode is set to 'untrusted'.

### 6.21.1.4 show queue cos-queue

This command displays the class-of-service queue configuration for the specified interface. The slot/port parameter is optional and is only valid on platforms that support independent per-port class of service mappings. If specified, the class-of-service queue configuration of the interface is displayed. If omitted, the most recent global configuration settings are displayed.



**Syntax**

```
show queue cos-queue <slot/port>
```

< slot/port > The interface number.

**Default Setting**

None

**Command Mode**

Privileged EXEC

**Display Message**

**Interface** This displays the slot/port of the interface. If displaying the global configuration, this output line is replaced with a Global Config indication.

**Interface Shaping Rate** The maximum transmission bandwidth limit for the interface as a whole. It is independent of any per-queue maximum bandwidth value(s) in effect for the interface. This is a configured value.

*The following information is repeated for each queue on the interface.*

**Queue Id** An interface supports n queues numbered 0 to (n-1). The specific n value is platform dependent.

**Minimum Bandwidth** The minimum transmission bandwidth guarantee for the queue, expressed as a percentage. A value of 0 means bandwidth is not guaranteed and the queue operates using best-effort. This is a configured value.

**Scheduler Type** Indicates whether this queue is scheduled for transmission using a strict priority or a weighted scheme. This is a configured value.

**Queue Mgmt Type** The queue depth management technique used for this queue, either tail drop or weighted random early discard (WRED). This is a configured value.

## 6.21.2 Configuration Commands

### 6.21.2.1 queue cos-map

This command maps an 802.1p priority to an internal traffic class on a "per-port" basis.

**Syntax**

```
queue cos-map <0-7> <0-7>
```

```
no queue cos-map
```

< 0-7 > - The range of queue priority is 0 to 7.

< 0-7 > - The range of mapped traffic class is 0 to 7.

no - Reset to the default mapping of the queue priority and the mapped traffic class.

### Default Setting

None

### Command Mode

Interface Config.

This command maps an 802.1p priority to an internal traffic class for a device.

### Syntax

```
queue cos-map all <0-7> <0-7>
```

```
no queue cos-map all
```

< 0-7 > - The range of queue priority is 0 to 7.

< 0-7 > - The range of mapped traffic class is 0 to 7.

no - Reset to the default mapping of the queue priority and the mapped traffic class.

### Default Setting

None

### Command Mode

Global Config.

### 6.21.2.2 queue trust

This command sets the class of service trust mode of an interface. You can set the mode to trust one of the Dot1p (802.1p) or IP DSCP packet markings. You can also set the interface mode to untrusted. If you configure an interface to use Dot1p, the mode does not appear in the output of the show running config command because Dot1p is the default.

**Syntax**

```
queue trust {dot1p | ip-dscp | untrusted } all
no queue trust all
```

**no** - This command sets the class of service trust mode to untrusted for all interfaces.

**Default Setting**

None

**Command Mode**

Global Config.

**6.21.2.3 queue cos-queue min-bandwidth**

This command specifies the minimum transmission bandwidth guarantee for each interface queue.

**Syntax**

```
queue cos-queue min-bandwidth <bw-0> <bw-1> ... <bw-6>
no queue cos-queue min-bandwidth
```

**<bw-0> <bw-1> ... <bw-6>**- Each Valid range is (0 to 100) in increments of 5 and the total sum is less than or equal to 100.

**no** - This command restores the default for each queue's minimum bandwidth value.

**Default Setting**

None

**Command Mode**

Interface Config.

This command specifies the minimum transmission bandwidth guarantee for each interface queue in the device.

**Syntax**

```
queue cos-queue min-bandwidth all <bw-0> <bw-1> ... <bw-6>  
no queue cos-queue min-bandwidth all
```

**<bw-0> <bw-1> ... <bw-6>**- Each Valid range is (0 to 100) in increments of 5 and the total sum is less than or equal to 100.

**no** - This command restores the default for each queue's minimum bandwidth value in the device.

**Default Setting**

None

**Command Mode**

Global Config.

**6.21.2.4 queue cos-queue strict**

This command activates the strict priority scheduler mode for each specified queue on a "per-port" basis.

**Syntax**

```
queue cos-queue strict <queue-id-0> [<queue-id-1> ... <queue-id-6>]  
no queue cos-queue strict <queue-id-0> [<queue-id-1> ... <queue-id-6>]
```

**no** - This command restores the default weighted scheduler mode for each specified

queue on a "per-port" basis.

**Default Setting**

None

**Command Mode**

Interface Config.

This command activates the strict priority scheduler mode for each specified queue on a device.

**Syntax**

```
queue cos-queue strict all <queue-id-0> [<queue-id-1> ... <queue-id-6>]  
no queue cos-queue strict all <queue-id-0> [<queue-id-1> ... <queue-id-6>]
```

**no** - This command restores the default weighted scheduler mode for each specified queue on a device.

**Default Setting**

None

**Command Mode**

Global Config.

**6.21.2.5 queue cos-queue traffic-shape**

This command specifies the maximum transmission bandwidth limit for the interface as a whole. Also known as rate shaping, this has the effect of smoothing temporary traffic bursts over time so that the transmitted traffic rate is bounded.

**Syntax**

```
queue cos-queue traffic-shape <bw>  
no queue cos-queue traffic-shape
```

**<bw>** - Valid range is (0 to 100) in increments 5.

**no** - This command restores the default shaping rate value.

**Default Setting**

None

**Command Mode**

Interface Config.

This command specifies the maximum transmission bandwidth limit for all interfaces. Also known as rate shaping, this has the effect of smoothing temporary traffic bursts over time so that the transmitted traffic rate is bounded.

**Syntax**

```
queue cos-queue traffic-shape all <bw>  
no queue cos-queue traffic-shape all
```

**<bw>** - Valid range is (0 to 100) in increments 5.

**no** - This command restores the default shaping rate value for all interfaces.

**Default Setting**

None

**Command Mode**

Global Config.

## 7 Routing Commands

### 7.1 Address Resolution Protocol (ARP) Commands

#### 7.1.1 Show Commands

##### 7.1.1.1 show ip arp

This command displays the Address Resolution Protocol (ARP) cache.

<b>Syntax</b>
---------------

<code>show ip arp</code>
--------------------------

**Default Setting**

None

**Command Mode**

Privileged Exec

**Display Message**

**Age Time:** Is the time it takes for an ARP entry to age out. This value was configured into the unit. Age time is measured in seconds.

**Response Time:** Is the time it takes for an ARP request timeout. This value was configured into the unit. Response time is measured in seconds.

**Retries:** Is the maximum number of times an ARP request is retried. This value was configured into the unit.

**Cache Size:** Is the maximum number of entries in the ARP table. This value was configured into the unit.

**Dynamic renew mode:** Displays whether the ARP component automatically attempts to renew dynamic ARP entries when they aged out.

**Total Entry Count Current/Peak:** Field listing the total entries in the ARP table and the peak entry count in the ARP table.

**Static Entry Count Configured/Active/Max:** Field listing configured static entry count, active static entry count, and maximum static entry count in the ARP table.

The following are displayed for each ARP entry.

**IP Address:** Is the IP address of a device on a subnet attached to an existing routing interface.

**MAC Address:** Is the hardware MAC address of that device.

**Interface:** Is the routing slot/port associated with the device ARP entry

**Type:** Is the type that was configured into the unit. The possible values are Local, Gateway, Dynamic and Static.

**Age:** This field displays the current age of the ARP entry since last refresh (in hh:mm:ss format).

### 7.1.1.2 show ip arp brief

This command displays the brief Address Resolution Protocol (ARP) table information.

<b>Syntax</b>
---------------

<pre>show ip arp brief</pre>
------------------------------

#### Default Setting

None

#### Command Mode

Privileged Exec

#### Display Message

**Age Time:** Is the time it takes for an ARP entry to age out. This value was configured into the unit. Age time is measured in seconds.

**Response Time:** Is the time it takes for an ARP request timeout. This value was configured into the unit. Response time is measured in seconds.

**Retries:** Is the maximum number of times an ARP request is retried. This value was configured into the unit.

**Cache Size:** Is the maximum number of entries in the ARP table. This value was configured into the unit.

**Dynamic renew mode:** Displays whether the ARP component automatically attempts to renew dynamic ARP entries when they aged out.

**Total Entry Count Current/Peak:** Field listing the total entries in the ARP table and the peak entry count in the ARP table.

**Static Entry Count Configured/Active/Max:** Field listing the configured static entry count, active static entry count, and maximum static entry count in the ARP table.

### 7.1.1.3 show ip arp static

This command displays the static Address Resolution Protocol (ARP) table information.

<b>Syntax</b>
---------------



```
show ip arp static
```

**Default Setting**

None

**Command Mode**

Privileged Exec

**Display Message**

**IP address:** Is the IP address of a device on a subnet attached to an existing routing interface.

**MAC address:** Is the MAC address for that device.

## 7.1.2 Configuration Commands

### 7.1.2.1 arp

This command creates an ARP entry. The value for <ipaddress> is the IP address of a device on a subnet attached to an existing routing interface. The value for <macaddress> is a unicast MAC address for that device.

**Syntax**

```
arp <ipaddr> <macaddr>  
no arp <ipaddr> <macaddr>
```

**<ipaddr>** - Is the IP address of a device on a subnet attached to an existing routing interface.

**<macaddr>** - Is a MAC address for that device. The format is 6 two-digit hexadecimal numbers that are separated by colons, for example, 00:06:29:32:81:40.

**no** - This command deletes an ARP entry.

**Default Setting**

None

**Command Mode**

Global Config

### 7.1.2.2 ip proxy-arp

This command enables proxy ARP on a router interface. Without proxy ARP, a device only responds to an ARP request if the target IP address is an address configured on the interface where the ARP request arrived. With proxy ARP, the device may also respond if the target IP

address is reachable. The device only responds if all next hops in its route to the destination are through interfaces other than the interface that received the ARP request.

**Syntax**

```
ip proxy-arp
no ip proxy-arp
```

**no** - This command disables proxy ARP on a router interface.

**Default Setting**

Enabled

**Command Mode**

Interface Config

**7.1.2.3 ip local-proxy-arp**

This command enables or disables Local Proxy ARP on an interface.

**Syntax**

```
ip local-proxy-arp
no ip local-proxy-arp
```

**no** - This command disables Local Proxy ARP on a router interface.

**Default Setting**

Enabled

**Command Mode**

Interface Config

**7.1.2.4 arp cachesize**

This command configures the maximum number of entries in the ARP cache.

**Syntax**

```
arp cachesize <384-3968>
no arp cachesize
```

**<384-3968>** - The range of cache size is 384 to 3968.

**no** - This command configures the default ARP cache size.

**Default Setting**

The default cache size is 3968.

**Command Mode**

Global Config

**7.1.2.5 arp dynamicrenew**

This command enables ARP component to automatically renew ARP entries of type dynamic when they age out.

**Syntax**

```
arp dynamicrenew  
no arp dynamicrenew
```

**no** - This command disables ARP component from automatically renewing ARP entries of type dynamic when they age out.

**Default Setting**

Enabled

**Command Mode**

Global Config

**7.1.2.6 arp purge**

This command causes the specified IP address to be removed from the ARP table. Only entries of type dynamic or gateway are affected by this command.

**Syntax**

```
arp purge <ipaddr>
```

**<ipaddr>** - The IP address to be removed from the ARP table.

**Default Setting**

None

**Command Mode**

Privileged Exec

### 7.1.2.7 arp resptime

This command configures the ARP request response timeout.

**Syntax**

```
arp resptime <1-10>  
no arp resptime
```

**<1-10>** - The range of default response time is 1 to 10 seconds.

**no** - This command configures the default response timeout time.

**Default Setting**

The default response time is 1.

**Command Mode**

Global Config

### 7.1.2.8 arp retries

This command configures the ARP count of maximum request for retries.

**Syntax**

```
arp retries <0-10>  
no arp retries
```

**<0-10>** - The range of maximum request for retries is 0 to 10.

**no** - This command configures the default count of maximum request for retries.

**Default Setting**

The default value is 4.

**Command Mode**

Global Config

### 7.1.2.9 arp timeout

This command configures the ARP entry ageout time.

**Syntax**

```
arp timeout <15-21600>  
no arp timeout
```

**<15-21600>** - Represents the IP ARP entry ageout time in seconds. The range is 15 to 21600 seconds.

**no** - This command configures the default ageout time for IP ARP entry.

**Default Setting**

The default value is 1200.

**Command Mode**

Global Config

**7.1.2.10 clear ip arp-cache**

This command causes all ARP entries of type dynamic to be removed from the ARP cache. If the [gateway] parameter is specified, the dynamic entries of type gateway are purged as well.

**Syntax**

```
clear ip arp-cache [gateway | interface <slot/port>]
```

**Default Setting**

None

**Command Mode**

Privileged Exec

**7.2 IP Routing Commands****7.2.1 Show Commands****7.2.1.1 show ip brief**

This command displays all the summary information of the IP.

**Syntax**

```
show ip brief
```

**Default Setting**

None

**Command Mode**

Privileged Exec, User Exec

**Display Message**

**Default Time to Live:** The computed TTL (Time to Live) of forwarding a packet from the local

router to the final destination.

**Routing Mode:** Show whether the routing mode is enabled or disabled.

**IP Forwarding Mode:** Disable or enable the forwarding of IP frames.

**Maximum Next Hops:** The maximum number of hops supported by this switch.

### 7.2.1.2 show ip interface port

This command displays all pertinent information about the IP interfaces.

<b>Syntax</b>
---------------

<b>show ip interface port &lt;slot/port&gt;</b>
---

#### Default Setting

None

#### Command Mode

Privileged Exec, User Exec

#### Display Message

**IP Address:** Is an IP address representing the subnet configuration of the router interface.

**Subnet Mask:** Is a mask of the network and host portion of the IP address for the router interface.

**Routing Mode:** Is the administrative mode of router interface participation. The possible values are enable or disable.

**Administrative Mode** Is the administrative mode of the specified interface. The possible values of this field are enable or disable. This value was configured into the unit.

**Forward Net Directed Broadcasts:** Displays whether forwarding of network-directed broadcasts is enabled or disabled.

**Active State:** Displays whether the interface is active or inactive. An interface is considered active if its link is up and it is in forwarding state.

**Link Speed Data Rate:** Is an integer representing the physical link data rate of the specified interface. This is measured in Megabits per second (Mbps).

**MAC Address:** Is the physical address of the specified interface.

**Encapsulation Type:** Is the encapsulation type for the specified interface.

**IP Mtu:** Is the Maximum Transmission Unit size of the IP packet.

### 7.2.1.3 show ip interface brief

This command displays summary information about IP configuration settings for all ports in the router.

**Syntax**

```
show ip interface brief
```

**Default Setting**

None

**Command Mode**

Privileged Exec, User Exec

**Display Message**

**Interface:** Valid slot, and port number separated by forward slashes.

**IP Address:** The IP address of the routing interface.

**IP Mask:** The IP mask of the routing interface.

**Netdir Bcast:** Indicates if IP forwards net-directed broadcasts on this interface. Possible values are Enable or Disable.

**MultiCast Fwd:** Indicates the multicast forwarding administrative mode on the interface. Possible values are Enable or Disable.

**7.2.1.4 show ip route**

This command displays the routing table. The <ip-address> specifies the network for which the route is to be displayed and displays the best matching best-route for the address. The <mask> specifies the subnet mask for the given <ip-address>. When you use the longerprefixes keyword, the <ip-address> and <mask> pair becomes the prefix, and the command displays the routes to the addresses that match that prefix. Use the <protocol> parameter to specify the protocol that installed the routes. The value for <protocol> can be **connected, ospf, rip, or static**. Use the all parameter to display all routes including best and nonbest routes. If you do not use the all parameter, the command only displays the best route.

**NOTE:** If you use the connected keyword for <protocol>, the all option is not available because there are no best or non-best connected routes.

**Syntax**

```
show ip route [{<ip-address> [<protocol>] | {<ip-address> <mask> [longer-prefixes] [<protocol>] | <protocol>} [all] | all}]
```

**Default Setting**

None

**Command Mode**

Privileged Exec

**Display Message**

**Route Codes:** Displays the key for the routing protocol codes that might appear in the routing table output.

The command displays the routing tables in the following format:  
Code IP-Address/Mask [Preference/Metric] via Next-Hop, Interface

**Code:** The codes for the routing protocols that created the routes.

**IP-Address/Mask:** The IP-Address and mask of the destination network corresponding to this route.

**Preference:** The administrative distance associated with this route. Routes with low values are preferred over routes with higher values.

**Metric:** The cost associated with this route.

**via Next-Hop:** The outgoing router IP address to use when forwarding traffic to the next router (if any) in the path toward the destination

**Interface:** The outgoing router interface to use when forwarding traffic to the next destination

**7.2.1.5 show ip route bestroutes**

This command displays router route table information for the best routes.

**Syntax**

```
show ip route bestroutes
```

**Default Setting**

None

**Command Mode**

Privileged Exec

**Display Message**

**Total Number of Routes:** The total number of routes.

**Network Address:** Is an IP route prefix for the destination.

**Subnet Mask:** Is a mask of the network and host portion of the IP address for the router interface.

**Protocol:** Tells which protocol added the specified route. The possibilities are: local, static, OSPF, or RIP.

*for each next hop*

**Next Hop Intf:** The outgoing router interface to use when forwarding traffic to the next destination.



**Next Hop IP Address:** The outgoing router IP address to use when forwarding traffic to the next router (if any) in the path toward the destination.

### 7.2.1.6 show ip route entry

This command displays the router route entry information.

<b>Syntax</b>
---------------

<b>show ip route entry &lt;networkaddress&gt;</b>
---

**<networkaddress>** - Is a valid network address identifying the network on the specified interface.

#### Default Setting

None

#### Command Mode

Privileged Exec

#### Display Message

**Network Address:** Is a valid network address identifying the network on the specified interface.

**Subnet Mask:** Is a mask of the network and host portion of the IP address for the attached network.

**Protocol:** Tells which protocol added the specified route. The possibilities are: local, static, OSPF, or RIP.

**Total Number of Routes:** The total number of routes.

*for each next hop*

**Next Hop Intf:** The outgoing router interface to use when forwarding traffic to the next destination.

**Next Hop IP Address:** The outgoing router IP address to use when forwarding traffic to the next router (if any) in the path toward the destination.

**Preference:** The preference value that is used for this route entry.

**Metric:** Specifies the metric for this route entry.

### 7.2.1.7 show ip route connected

This command displays directly connected routes.

**Syntax**

```
show ip route connected
```

**Default Setting**

None

**Command Mode**

Privileged Exec

**Display Message**

**Route Codes:** Displays the key for the routing protocol codes that might appear in the routing table output.

The command displays the routing tables in the following format:  
Code IP-Address/Mask [Preference/Metric] via Next-Hop, Interface

**Code:** The codes for the routing protocols that created the routes.

**IP-Address/Mask:** The IP-Address and mask of the destination network corresponding to this route.

**Preference:** The administrative distance associated with this route. Routes with low values are preferred over routes with higher values.

**Metric:** The cost associated with this route.

**via Next-Hop:** The outgoing router IP address to use when forwarding traffic to the next router (if any) in the path toward the destination

**Interface:** The outgoing router interface to use when forwarding traffic to the next destination

**7.2.1.8 show ip route ospf**

This command displays Open Shortest Path First (OSPF) routes. The option **all** command displays all (best and non-best) routes.

**Syntax**

```
show ip route ospf [all]
```

**Default Setting**

None

**Command Mode**

Privileged Exec

**Display Message**

**Route Codes:** Displays the key for the routing protocol codes that might appear in the routing table output.

The command displays the routing tables in the following format:  
Code IP-Address/Mask [Preference/Metric] via Next-Hop, Interface

**Code:** The codes for the routing protocols that created the routes.

**IP-Address/Mask:** The IP-Address and mask of the destination network corresponding to this route.

**Preference:** The administrative distance associated with this route. Routes with low values are preferred over routes with higher values.

**Metric:** The cost associated with this route.

**via Next-Hop:** The outgoing router IP address to use when forwarding traffic to the next router (if any) in the path toward the destination

**Interface:** The outgoing router interface to use when forwarding traffic to the next destination

### 7.2.1.9 show ip route rip

This command displays Routing Information Protocol (RIP) routes. The option **all** command displays all (best and non-best) routes.

<b>Syntax</b>
---------------

<b>show ip route rip [all]</b>
--------------------------------

#### Default Setting

None

#### Command Mode

Privileged Exec

#### Display Message

**Route Codes:** Displays the key for the routing protocol codes that might appear in the routing table output.

The command displays the routing tables in the following format:  
Code IP-Address/Mask [Preference/Metric] via Next-Hop, Interface

**Code:** The codes for the routing protocols that created the routes.

**IP-Address/Mask:** The IP-Address and mask of the destination network corresponding to this route.

**Preference:** The administrative distance associated with this route. Routes with low values are preferred over routes with higher values.

**Metric:** The cost associated with this route.

**via Next-Hop:** The outgoing router IP address to use when forwarding traffic to the next router (if any) in the path toward the destination

**Interface:** The outgoing router interface to use when forwarding traffic to the next destination

### 7.2.1.10 show ip route static

This command displays Static Routes. The option **all** command displays all (best and non-best) routes.

**Syntax**

```
show ip route static [all]
```

**Default Setting**

None

**Command Mode**

Privileged Exec

**Display Message**

**Route Codes:** Displays the key for the routing protocol codes that might appear in the routing table output.

The command displays the routing tables in the following format:  
Code IP-Address/Mask [Preference/Metric] via Next-Hop, Interface

**Code:** The codes for the routing protocols that created the routes.

**IP-Address/Mask:** The IP-Address and mask of the destination network corresponding to this route.

**Preference:** The administrative distance associated with this route. Routes with low values are preferred over routes with higher values.

**Metric:** The cost associated with this route.

**via Next-Hop:** The outgoing router IP address to use when forwarding traffic to the next router (if any) in the path toward the destination

**Interface:** The outgoing router interface to use when forwarding traffic to the next destination

### 7.2.1.11 show ip route summary

This command displays the routing table summary. Use the optional **all** parameter to show the number of all routes, including best and non-best routes. To include only the number of best routes, do not use the optional parameter.

**Syntax**

```
show ip route summary [all]
```

**Default Setting**

None

**Command Mode**

Privileged Exec

### Display Message

**Connected Routes:** The total number of connected routes in the routing table.

**Static Routes:** Total number of static routes in the routing table.

**RIP Routes:** Total number of routes installed by RIP protocol.

**OSPF Routes:** Total number of routes installed by OSPF protocol.

**Total Routes:** Total number of routes in the routing table.

#### 7.2.1.12 show ip route precedence

This command displays detailed information about the route preferences. Route preferences are used in determining the best route. Lower router preference values are preferred over higher router preference values.

<b>Syntax</b>
---------------

<b>show ip route preferences</b>
----------------------------------

### Default Setting

None

### Command Mode

Privileged Exec, User Exec

### Display Message

**Local:** This field displays the local route preference value.

**Static:** This field displays the static route preference value.

**OSPF Intra:** This field displays the OSPF intra route preference value.

**OSPF Inter:** This field displays the OSPF inter route preference value.

**OSPF Ext T1:** This field displays the OSPF Type-1 route preference value.

**OSPF Ext T2:** This field displays the OSPF Type-2 route preference value.

**RIP:** This field displays the RIP route preference value.

#### 7.2.1.13 show ip traffic

This command displays IP statistical information. Refer to RFC 1213 for more information about the fields that are displayed.

<b>Syntax</b>
---------------

<b>show ip traffic</b>
------------------------

**Default Setting**

None

**Command Mode**

Privileged Exec, User Exec

**7.2.2 Configuration Commands****7.2.2.1 routing**

This command enables routing for an interface.

**Syntax**

```
routing
no routing
```

**no** - Disable routing for an interface.

**Default Setting**

Enabled

**Command Mode**

Interface Config

**7.2.2.2 ip routing**

This command enables the IP Router Admin Mode for the master switch.

**Syntax**

```
ip routing
no ip routing
```

**no** - Disable the IP Router Admin Mode for the master switch.

**Default Setting**

Enabled

**Command Mode**

Global Config

### 7.2.2.3 ip address

This command configures an IP address on an interface. The IP address may be a secondary IP address.

#### Syntax

```
ip address <ipaddr> <subnet-mask> [secondary]
no ip address <ipaddr> <subnet-mask> [secondary]
```

<ipaddr> - IP address of the interface.

<subnet-mask> - Subnet mask of the interface.

[secondary] - It is a secondary IP address.

no - Delete an IP address from an interface.

#### Default Setting

None

#### Command Mode

Interface Config

### 7.2.2.4 ip route

This command configures a static route.

#### Syntax

```
ip route <networkaddr> <subnetmask> [ <nexthopip> [<1-255 >] ]
no ip route <networkaddr> <subnetmask> [ { <nexthopip> | <1-255 > } ]
```

<ipaddr> - A valid IP address .

<subnetmask> - A valid subnet mask.

<nexthopip> - IP address of the next hop router.

<1-255> - The precedence value of this route. The range is 1 to 255.

no - delete all next hops to a destination static route. If the optional <nextHopRtr> parameter is designated, the next hop is deleted and if the optional precedence value is designated, the precedence value of the static route is reset to its default value 1.

#### Default Setting

None

#### Command Mode

Global Config

### 7.2.2.5 ip route default-next-hop

This command configures the default route.

**Syntax**

```
ip route default-next-hop <nexthopip> [1-255]
```

<nexthopip> - IP address of the next hop router.

<1-255> - Precedence value of this route.

**Default Setting**

None

**Command Mode**

Global Config

### 7.2.2.6 ip route precedence

This command sets the default precedence for static routes. Lower route preference values are preferred when determining the best route. The "ip route" and "ip default-next-hop" commands allow you to optionally set the precedence of an individual static route. The default precedence is used when no precedence is specified in these commands. Changing the default precedence does not update the precedence of existing static routes, even if they were assigned the original default precedence. The new default precedence will only be applied to static routes created after invoking the "ip route precedence" command.

**Syntax**

```
ip route precedence <1-255>
```

<1-255> - Default precedence value of static routes. The range is 1 to 255.

**Default Setting**

The default precedence value is 1.

**Command Mode**

Global Config



### 7.2.2.7 ip forwarding

This command enables forwarding of IP frames.

<b>Syntax</b>
---------------

<b>ip forwarding</b> <b>no ip forwarding</b>
---

**no** - Disable forwarding of IP frames.

#### Default Setting

Enabled

#### Command Mode

Global Config

### 7.2.2.8 ip directed-broadcast

This command enables the forwarding of network-directed broadcasts. When enabled, network directed broadcasts are forwarded. When disabled they are dropped.

<b>Syntax</b>
---------------

<b>ip directed-broadcast</b> <b>no ip directed-broadcast</b>
---

**no** - Drop network directed broadcast packets.

#### Default Setting

Enabled

#### Command Mode

Interface Config

### 7.2.2.9 ip mtu

This command sets the IP Maximum Transmission Unit (MTU) on a routing interface. The IP MTU is the size of the largest IP packet that can be transmitted on the interface without fragmentation.

**Syntax**

```
ip mtu <68-1500>
no ip mtu <68-1500>
```

<68-1500> - The IP MTU on a routing interface. The range is 68 to 1500.

no - Reset the ip mtu to the default value.

**Default Setting**

The default value is 1500.

**Command Mode**

Interface Config

**7.2.2.10 encapsulation**

This command configures the link layer encapsulation type for the packet.

**Syntax**

```
encapsulation {ethernet | snap}
```

**ethernet** - The link layer encapsulation type is ethernet.

**snap** - The link layer encapsulation type is SNAP.

**Default Setting**

The default value is ethernet.

**Command Mode**

Interface Config

**Restrictions**

Routed frames are always Ethernet encapsulated when a frame is routed to a VLAN.

**7.3 Open Shortest Path First (OSPF) Commands****7.3.1 Show Commands**

### 7.3.1.1 show ip ospf

This command displays information relevant to the OSPF router

<b>Syntax</b>
---------------

<code>show ip ospf</code>
---------------------------

#### Default Setting

None

#### Command Mode

Privileged Exec

#### Display Messages

**Router ID** Is a 32 bit integer in dotted decimal format identifying the router.

**OSPF Admin Mode** The administrative mode of OSPF in the router.

**ASBR Mode** Reflects whether the ASBR mode is enabled or disabled. Enable implies that the router is an autonomous system border router. Router automatically becomes an ASBR when it is configured to redistribute routes learned from other protocol. The possible values for the ASBR status is enabled (if the router is configured to re-distribute routes learnt by other protocols) or disabled (if the router is not configured for the same).

**RFC 1583 Compatibility** Reflects whether 1583 compatibility is enabled or disabled. This is a configured value.

**ABR Status** Reflects the whether or not the router is an OSPF Area Border Router.

**Exit Overflow Interval** The number of seconds that, after entering OverflowState, a router will attempt to leave OverflowState.

**External LSA count** The number of external (LS type 5) link-state advertisements in the link-state database.

**External LSA Checksum** A number which represents the sum of the LS checksums of external link-state advertisements contained in the link-state database.

**New LSAs Originated** The number of new link-state advertisements that have been originated.

**LSAs Received** The number of link-state advertisements received determined to be new instantiations.

**External LSDB Limit** The maximum number of non-default AS-external-LSAs entries that can be stored in the link-state database.

**Default-metric** RDefault value for redistributed routes.

**Default Route Advertise** Enable or Disable Default Route Advertise.

**Always** Sets the router advertise 0.0.0.0/0.0.0.0 when set to "True".

**Metric** Specifies the metric of the default route. The valid values are (0 to 16777215).

**Metric Type** Metric type of the default route. The valid values are External Type 1 and External Type 2.

**Maximum Paths** Maximum number of paths that OSPF can report for a given destination.

### 7.3.1.2 show ip ospf area

This command displays information relevant to the OSPF router

<b>Syntax</b>
---------------

<code>show ip ospf area &lt;areaid&gt;</code>
---

#### Default Setting

None

#### Command Mode

Privileged Exec, User Exec

#### Display Messages

**AreaID** Is the area id of the requested OSPF area.

**Aging Interval** Is a number representing the aging interval for this area.

**External Routing** Is a number representing the external routing capabilities for this area.

**Spf Runs** Is the number of times that the intra-area route table has been calculated using this area's link-state database.

**Area Border Router Count** The total number of area border routers reachable within this area.

**Area LSA Count** Total number of link-state advertisements in this area's link-state database, excluding AS external LSA's.

**Area LSA Checksum** A number representing the area LSA checksum for the specified AreaID excluding the external (LS type 5) link-state advertisements.

**Stub Mode** Represents whether the specified Area is a stub area or not. The possible values are enabled and disabled. This is a configured value.

**Import Summary LSAs** Enable to import LSAs into stub area.

### 7.3.1.3 show ip ospf abr

This command displays the internal OSPF routing table entries to Area Border Routers (ABR). This command takes no options.

<b>Syntax</b>
---------------

<code>show ip ospf abr</code>
-------------------------------

#### Default Setting

None

#### Command Mode

Privileged Exec, User Exec

### Display Messages

**Type:** The type of the route to the destination. It can be either:

intra — Intra-area route

inter — Inter-area route

**Router ID:** Router ID of the destination

**Cost:** Cost of using this route

**Area ID:** The area ID of the area from which this route is learned.

**Next Hop:** Next hop toward the destination

**Next Hop Intf:** The outgoing router interface to use when forwarding traffic to the next hop.

#### 7.3.1.4 show ip ospf asbr

This command displays the internal OSPF routing table entries to Autonomous System Boundary Routers (ASBR). This command takes no options.

<b>Syntax</b>
---------------

<pre>show ip ospf asbr</pre>
------------------------------

### Default Setting

None

### Command Mode

Privileged Exec, User Exec

### Display Messages

**Type:** The type of the route to the destination. It can be either:

intra — Intra-area route

inter — Inter-area route

**Router ID:** Router ID of the destination

**Cost:** Cost of using this route

**Area ID:** The area ID of the area from which this route is learned.

**Next Hop:** Next hop toward the destination

**Next Hop Intf:** The outgoing router interface to use when forwarding traffic to the next hop.

#### 7.3.1.5 show ip ospf database

This command displays information about the link state database when OSPF is enabled. If you do not enter any parameters, the command displays the LSA headers for all areas. Use the optional **<areaid>** parameter to display database information about a specific area. Use the optional parameters to specify the type of link state advertisements to display. Use **asbrsummary** to show the autonomous system boundary router (ASBR) summary LSAs. Use **external** to display the external LSAs. Use **network** to display the network LSAs. Use **nssaexternal** to display NSSA external LSAs. Use **router** to display router LSAs. Use **summary** to show the LSA database summary information. Use **<lsid>** to specify the link state ID (LSID). The value of **<lsid>** can be an IP address or an integer in the range of 0-4294967295. Use

adv-router to show the LSAs that are restricted by the advertising router. Use selforiginate to display the LSAs in that are self originated. The information below is only displayed if OSPF is enabled.

**Syntax**

```
show ip ospf [<areaid>] database [{asbr-summary | external | network | nssa-external | router | summary}] [<lsid>] [{advrouter [<rtrid>] | self-originate}]
```

<areaid> - Configures to display database information about a specific area.

<lsid>- Specify the link state ID.

<rtrid>- Specify an IP Address.

**Default Setting**

None

**Command Mode**

Privileged Exec, User Exec

**Display Messages**

**Link Id:** Is a number that uniquely identifies an LSA that a router originates from all other self originated LSA's of the same LS type.

**Adv Router:** The Advertising Router. Is a 32 bit dotted decimal number representing the LSDB interface.

**Age:** Is a number representing the age of the link state advertisement in seconds.

**Sequence:** Is a number that represents which LSA is more recent.

**Checksum:** Is the total number LSA checksum.

**Options:** This is an integer. It indicates that the LSA receives special handling during routing calculations.

**Rtr Opt:** Router Options are valid for router links only.

**7.3.1.6 show ip ospf database database-summary**

This command displays the number of each type of LSA in the database for each area and for the router. The command also displays the total number of LSAs in the database.

**Syntax**

```
show ip ospf database database-summary
```

**Default Setting**

None

**Command Mode**

Privileged Exec, User Exec

### Display Messages

**Router:** Total number of router LSAs in the OSPF link state database.

**Network:** Total number of network LSAs in the OSPF link state database.

**Summary Net:** Total number of summary network LSAs in the database.

**Summary ASBR:** Number of summary ASBR LSAs in the database.

**Type-7 Ext:** Total number of Type-7 external LSAs in the database.

**Self-Originated Type-7:** Total number of self originated AS external LSAs in the OSPFv3 link state database.

**Opaque Link:** Number of opaque link LSAs in the database.

**Opaque Area:** Number of opaque area LSAs in the database.

**Subtotal:** Number of entries for the identified area.

**Total:** Number of entries for all areas.

### 7.3.1.7 show ip ospf interface

This command displays the information for the IFO object or virtual interface tables.

#### Syntax

```
show ip ospf interface {<slot/port> | loopback <0-7>}
```

<slot/port> - Interface number.

<0-7> - Loopback Interface ID.

### Default Setting

None

### Command Mode

Privileged Exec, User Exec

### Display Messages

**IP Address** Represents the IP address for the specified interface. This is a configured value.

**Subnet Mask** Is a mask of the network and host portion of the IP address for the OSPF interface. This value was configured into the unit. This is a configured value.

**OSPF Admin Mode** States whether OSPF is enabled or disabled on a router interface. This is a configured value.

**OSPF Area ID** Represents the OSPF Area Id for the specified interface. This is a configured value.

**Router Priority** A number representing the OSPF Priority for the specified interface. This is a configured value.

**Retransmit Interval** A number representing the OSPF Retransmit Interval for the specified interface. This is a configured value.

**Hello Interval** A number representing the OSPF Hello Interval for the specified interface. This is a configured value.

**Dead Interval** A number representing the OSPF Dead Interval for the specified interface. This is a configured value.

**LSA Ack Interval** A number representing the OSPF LSA Acknowledgement Interval for the specified interface.

**IfTransit Delay Interval** A number representing the OSPF Transit Delay for the specified interface. This is a configured value.

**Authentication Type** The OSPF Authentication Type for the specified interface are: none, simple, and encrypt. This is a configured value.

**The information below will only be displayed if OSPF is enabled.**

**OSPF Interface Type:** Broadcast LANs, such as Ethernet and IEEE 802.5, take the value broadcast. The OSPF Interface Type will be 'broadcast'.

**State:** The OSPF Interface States are: down, loopback, waiting, point-to-point, designated router, and backup designated router.

**Designated Router:** The router ID representing the designated router.

**Backup Designated Router:** The router ID representing the backup designated router.

**Number of Link Events:** The number of link events.

**Metric Cost:** The cost of the OSPF interface.

### 7.3.1.8 show ip ospf interface brief

This command displays brief information for the IFO object or virtual interface tables.

<b>Syntax</b>	<b>show ip ospf interface brief</b>
---------------	-------------------------------------

#### Default Setting

None

#### Command Mode

Privileged Exec, User Exec

#### Display Messages

**Interface** Valid slot and port number separated by forward slashes.

**Admin Mode** States whether OSPF is enabled or disabled on a router interface. This is a configured value.

**Area ID** Represents the OSPF Area Id for the specified interface. This is a configured value.

**Router Priority** A number representing the OSPF Priority for the specified interface. This is a configured value.

**Hello Interval** A number representing the OSPF Hello Interval for the specified interface. This is a configured value.

**Dead Interval** A number representing the OSPF Dead Interval for the specified interface. This is a configured value.

**Retrax Interval** A number representing the OSPF Retransmit Interval for the specified interface. This is a configured value.

**Retrax Delay** A number representing the OSPF Transit Delay for the specified interface. This is a configured value.



**LSAAck Interval** A number representing the OSPF LSA Acknowledgement Interval for the specified interface.

### 7.3.1.9 show ip ospf interface stats

This command displays the statistics for a specific interface.

#### Syntax

```
show ip ospf interface stats <slot/port>
```

<slot/port> - Interface number.

#### Default Setting

None

#### Command Mode

Privileged Exec, User Exec

#### Display Messages

**OSPF Area ID** The area id of this OSPF interface.

**Spf Runs** The number of times that the intra-area route table has been calculated using this area's link-state database.

**Area Border Router Count** The total number of area border routers reachable within this area. This is initially zero, and is calculated in each SPF pass.

**AS Border Router Count** The total number of Autonomous System border routers reachable within this area.

**Area LSA Count** The total number of link-state advertisements in this area's link-state database, excluding AS External LSAs.

**IP Address** The IP address associated with this OSPF interface.

**OSPF Interface Events** The number of times the specified OSPF interface has changed its state, or an error has occurred.

**Virtual Events** The number of state changes or errors that occurred on this virtual link.

**Neighbor Events** The number of times this neighbor relationship has changed state, or an error has occurred.

**External LSA Count** The number of external (LS type 5) link-state advertisements in the link-state database.

**LSAs Received** The number of LSAs received.

**Originate New LSAs** The number of LSAs originated.

### 7.3.1.10 show ip ospf neighbor

This command displays information about OSPF neighbors. If you do not specify a neighbor IP address, the output displays summary information in a table. If you specify an interface or tunnel, only the information for that interface or tunnel displays. The <ipaddr> is the IP address

of the neighbor, and when you specify this, detailed information about the neighbor displays. The information below only displays if OSPF is enabled and the interface has a neighbor.

**Syntax**

```
show ip ospf neighbor [interface <slot/port>] [<ipaddr>]
```

<ipaddr> - IP address of the neighbor.

<slot/port> - Interface number.

**Default Setting**

None

**Command Mode**

Privileged Exec, User Exec

**Display Messages**

**Interface** Is the interface number.

**Router Id** Is a 4-digit dotted-decimal number identifying neighbor router.

**Options** An integer value that indicates the optional OSPF capabilities supported by the neighbor. The neighbor's optional OSPF capabilities are also listed in its Hello packets. This enables received Hello Packets to be rejected (i.e., neighbor relationships will not even start to form) if there is a mismatch in certain crucial OSPF capabilities.

**Router Priority** Displays the OSPF priority for the specified interface. The priority of an interface is a priority integer from 0 to 255. A value of '0' indicates that the router is not eligible to become the designated router on this network.

**State** The types are:

*Down* - initial state of the neighbor conversation - no recent information has been received from the neighbor.

*Attempt* - no recent information has been received from the neighbor but a more concerted effort should be made to contact the neighbor.

*Init* - an Hello packet has recently been seen from the neighbor, but bi-directional communication has not yet been established.

*2 way* - communication between the two routers is bi-directional.

*Exchange start* - the first step in creating an adjacency between the two neighboring routers, the goal is to decide which router is the master and to decide upon the initial DD sequence number.

*Exchange* - the router is describing its entire link state database by sending Database Description packets to the neighbor.

*Loading* - Link State Request packets are sent to the neighbor asking for the more recent LSAs that have been discovered (but not yet received) in the Exchange state.

*Full* - the neighboring routers are fully adjacent and they will now appear in router-LSAs and network-LSAs.

**Events** The number of times this neighbor relationship has changed state, or an error has occurred.

**Permanence** This variable displays the status of the entry, either dynamic or permanent. This refers to how the neighbor became known.

**Hellos Suppressed** This indicates whether Hellos are being suppressed to the neighbor. The types are enabled and disabled.

**Retransmission Queue Length** Is an integer representing the current length of the

retransmission queue of the specified neighbor router Id of the specified interface.

**If you do not specify an IP address, a table with the following columns displays for all neighbors or the neighbor associated with the interface that you specify:**

**Router ID** Shows the 4-digit dotted-decimal number of the neighbor router.

**Priority** Displays the OSPF priority for the specified interface. The priority of an interface is a priority integer from 0 to 255. A value of '0' indicates that the router is not eligible to become the designated router on this network.

**IP Address** Shows the IP address of the neighbor.

**Interface** Shows the interface of the local router in slot/port format.

**State** Shows the state of the neighboring routers. Possible values are:

Down- initial state of the neighbor conversation - no recent information has been received from the neighbor.

Attempt - no recent information has been received from the neighbor but a more concerted effort should be made to contact the neighbor.

Init - an Hello packet has recently been seen from the neighbor, but bidirectional communication has not yet been established.

2 way - communication between the two routers is bidirectional.

Exchange start - the first step in creating an adjacency between the two neighboring routers, the goal is to decide which router is the master and to decide upon the initial DD sequence number.

Exchange - the router is describing its entire link state database by sending Database Description packets to the neighbor.

Loading - Link State Request packets are sent to the neighbor asking for the more recent LSAs that have been discovered (but not yet received) in the Exchange state.

Full - the neighboring routers are fully adjacent and they will now appear in router-LSAs and network-LSAs.

**Dead Time** Shows the amount of time, in seconds, to wait before the router assumes the neighbor is unreachable.

**If you specify an IP address for the neighbor router, the following fields display:**

**Interface** Valid slot and port number separated by forward slashes.

**Neighbor IP Address** Shows the IP address of the neighbor router.

**Interface Index** Shows the interface ID of the neighbor router.

**Area ID** Shows the area ID of the OSPF area associated with the interface.

**Options** An integer value that indicates the optional OSPF capabilities supported by the neighbor. The neighbor's optional OSPF capabilities are also listed in its Hello packets. This enables received Hello Packets to be rejected (i.e., neighbor relationships will not even start to form) if there is a mismatch in certain crucial OSPF capabilities.

**Router Priority** Displays the OSPF priority for the specified interface. The priority of an interface is a priority integer from 0 to 255. A value of '0' indicates that the router is not eligible to become the designated router on this network.

**Dead Timer Due** Shows the amount of time, in seconds, to wait before the router assumes the neighbor is unreachable.

**State** Shows the state of the neighboring routers.

**Events** The number of times this neighbor relationship has changed state, or an error has occurred.

**Retransmission Queue Length** Is an integer representing the current length of the retransmission queue of the specified neighbor router Id of the specified interface.

### 7.3.1.11 show ip ospf neighbor brief

This command displays the OSPF neighbor table list. When a particular neighbor ID is specified, detailed information about a neighbor is given. The information will only be displayed if OSPF is enabled.

<b>Syntax</b>
---------------

<b>show ip ospf neighbor brief {&lt;slot/port&gt;   all}</b>
--

#### Default Setting

None

#### Command Mode

Privileged Exec, User Exec

#### Display Messages

**Router ID** A 4 digit dotted decimal number representing the neighbor interface.

**IP Address** An IP address representing the neighbor interface.

**Neighbor Interface Index** Is a slot/port identifying the neighbor interface index.

**State** The types are:

*Down*- initial state of the neighbor conversation - no recent information has been received from the neighbor.

*Attempt* - no recent information has been received from the neighbor but a more concerted effort should be made to contact the neighbor.

*Init* - an Hello packet has recently been seen from the neighbor, but bi-directional communication has not yet been established.

*2 way* - communication between the two routers is bi-directional.

*Exchange start* - the first step in creating an adjacency between the two neighboring routers, the goal is to decide which router is the master and to decide upon the initial DD sequence number.

*Exchange* - the router is describing its entire link state database by sending Database Description packets to the neighbor.

*Loading* - Link State Request packets are sent to the neighbor asking for the more recent LSAs that have been discovered (but not yet received) in the Exchange state.

*Full* - the neighboring routers are fully adjacent and they will now appear in router-LSAs and network-LSAs.

### 7.3.1.12 show ip ospf range

This command displays information about the area ranges for the specified <areaid>. The <areaid> identifies the OSPF area whose ranges are being displayed.

**Syntax**

```
show ip ospf range <areaid>
```

<areaid> - The area id of the requested OSPF area

**Default Setting**

None

**Command Mode**

Privileged Exec, User Exec

**Display Messages**

**Area ID** The area id of the requested OSPF area.

**IP Address** An IP Address which represents this area range.

**Subnet Mask** A valid subnet mask for this area range.

**Lsdb Type** The type of link advertisement associated with this area range.

**Advertisement** The status of the advertisement. Advertisement has two possible settings: enabled or disabled.

**7.3.1.13 show ip ospf statistics**

This command displays information about recent Shortest Path First (SPF) calculations. The SPF is the OSPF routing table calculation. The output lists the number of times the SPF has run for each OSPF area. A table follows this information. For each of the 15 most recent SPF runs, the table lists how long ago the SPF ran, how long the SPF took, and the reasons why the SPF was scheduled.

**Syntax**

```
show ip ospf statistics
```

**Default Setting**

None

**Command Mode**

Privileged Exec, User Exec

**Display Messages**

**Delta T** How long ago the SPF ran. The time is in the format hh:mm:ss, giving the hours, minutes, and seconds since the SPF run.

**SPF Duration** How long the SPF took in milliseconds.

**Reason** The reason the SPF was scheduled. Reason codes are as follows:

R - a router LSA has changed

N - a network LSA has changed

SN - a type 3 network summary LSA has changed

SA - a type 4 ASBR summary LSA has changed  
X - a type 5 or type 7 external LSA has changed

### 7.3.1.14 show ip ospf stub table

This command displays the OSPF stub table. The information will only be displayed if OSPF is initialized on the switch.

<b>Syntax</b>
---------------

<code>show ip ospf stub table</code>
--------------------------------------

#### Default Setting

None

#### Command Mode

Privileged Exec, User Exec

#### Display Messages

**Area ID** Is a 32-bit identifier for the created stub area.

**Type of Service** Is the type of service associated with the stub metric. FASTPATH only supports Normal TOS.

**Metric Val** The metric value is applied based on the TOS. It defaults to the least metric of the type of service among the interfaces to other areas. The OSPF cost for a route is a function of the metric value.

**Metric Type** Is the type of metric advertised as the default route.

**Import Summary LSA** Controls the import of summary LSAs into stub areas.

### 7.3.1.15 show ip ospf virtual-link

This command displays the OSPF Virtual Interface information for a specific area and neighbor.

<b>Syntax</b>
---------------

<code>show ip ospf virtual-link &lt;areaid&gt; &lt;neighbor&gt;</code>
--

**<areaid>** - Area ID.

**<neighbor>** - Neighbor's router ID.

**Default Setting**

None

**Command Mode**

Privileged Exec, User Exec

**Display Messages****Area ID** The area id of the requested OSPF area.**Neighbor Router ID** The input neighbor Router ID.**Hello Interval** The configured hello interval for the OSPF virtual interface.**Dead Interval** The configured dead interval for the OSPF virtual interface.**Iftransit Delay Interval** The configured transit delay for the OSPF virtual interface.**Retransmit Interval** The configured retransmit interval for the OSPF virtual interface.**State** The OSPF Interface States are: down, loopback, waiting, point-to-point, designated router, and backup designated router. This is the state of the OSPF interface.**Metric** The metric value.**Neighbor State** The neighbor state.**Authentication Type** The configured authentication type of the OSPF virtual interface.**7.3.1.16 show ip ospf virtual-link brief**

This command displays the OSPF Virtual Interface information for all areas in the system.

**Syntax**

```
show ip ospf virtual-link brief
```

**Default Setting**

None

**Command Mode**

Privileged Exec, User Exec

**Display Messages****Area Id** Is the area id of the requested OSPF area.**Neighbor** Is the neighbor interface of the OSPF virtual interface.**Hello Interval** Is the configured hello interval for the OSPF virtual interface.**Dead Interval** Is the configured dead interval for the OSPF virtual interface.**Retransmit Interval** Is the configured retransmit interval for the OSPF virtual interface.**Transit Delay** Is the configured transit delay for the OSPF virtual interface.

## 7.3.2 Configuration Commands

### 7.3.2.1 enable ospf

This command resets the default administrative mode of OSPF in the router to active.

<b>Syntax</b>
---------------

<code>enable</code> <code>no enable</code>
---

**<no>** - This command sets the administrative mode of OSPF in the router to inactive.

#### Default Setting

Enabled

#### Command Mode

Router OSPF Config

### 7.3.2.2 no area

This command removes an OSPF area.

<b>Syntax</b>
---------------

<code>no area &lt;areaid&gt;</code>
-------------------------------------

#### Default Setting

None

#### Command Mode

Router OSPF Config



### 7.3.2.3 ip ospf

This command enables OSPF on a router interface.

<b>Syntax</b>
---------------

<pre>ip ospf no ip ospf</pre>
-------------------------------

<no> - This command disables OSPF on a router interface.

#### Default Setting

Disabled

#### Command Mode

Interface Config

### 7.3.2.4 1583compatibility

This command enables OSPF 1583 compatibility. Note that if all OSPF routers in the routing domain are capable of operating according to RFC 2328, OSPF 1583 compatibility mode should be disabled.

<b>Syntax</b>
---------------

<pre>1583compatibility no 1583compatibility</pre>
---

<no> - This command disables OSPF 1583 compatibility.

#### Default Setting

Enabled

#### Command Mode

Router OSPF Config

### 7.3.2.5 area default-cost

This command configures the monetary default cost for the stub area.

**Syntax**

```
area <areaid> default-cost <1-16777215>
```

<areaid> - Area ID

<1-16777215> - The default cost value. The range is 1 to 16777215.

**Default Setting**

None

**Command Mode**

Router OSPF Config

### 7.3.2.6 area nssa

This command configures the specified areaid to function as an NSSA.

**Syntax**

```
area <areaid> nssa  
no area <areaid> nssa
```

<areaid> - Area ID.

<no> - This command disables nssa from the specified area id.

**Default Setting**

None

**Command Mode**

Router OSPF Config

### 7.3.2.7 area nssa default-info-originate

This command configures the metric value and type for the default route advertised into the NSSA. The optional metric parameter specifies the metric of the default route and is to be in a range of 1-16777214. If no metric is specified, the default value is \*\*\*\*. The metric type can be comparable (nssa-external 1) or non-comparable (nssa-external 2).

**Syntax**

```
area <areaid> nssa default-info-originate [<1-16777214>] [{comparable | non-comparable}]
```

<areaid> - Area ID.

<1-16777214> - The metric of the default route. The range is 1 to 16777214.

**comparable** - It's NSSA-External 1.

**non-comparable** - It's NSSA-External 2.

**Default Setting**

None

**Command Mode**

Router OSPF Config

**7.3.2.8 area nssa no-redistribute**

This command configures the NSSA ABR so that learned external routes will not be redistributed to the NSSA.

**Syntax**

```
area <areaid> nssa no-redistribute
```

<areaid> - Area ID.

**Default Setting**

None

**Command Mode**

Router OSPF Config

**7.3.2.9 area nssa no-summary**

This command configures the NSSA so that summary LSAs are not advertised into the NSSA

**Syntax**

```
area <areaid> nssa no- summary
```

<areaid> - Area ID.

**Default Setting**

None

**Command Mode**

Router OSPF Config

**7.3.2.10 area nssa translator-role**

This command configures the translator role of the NSSA.

**Syntax**

```
area <areaid> nssa translator-role {always | candidate}  
no area <areaid> nssa translator-role
```

<areaid> - Area ID.

**always** - A value of *always* will cause the router to assume the role of the translator when it becomes a border router.

**candidate** - a value of *candidate* will cause the router to participate in the translator election process when it attains border router status.

**no** - Disables the nssa translator role from the specified area id.

**Default Setting**

None

**Command Mode**

Router OSPF Config

**7.3.2.11 area nssa translator-stab-intv**

This command configures the translator stability interval of the NSSA. The <stabilityinterval> is the period of time that an elected translator continues to perform its duties after it determines that its translator status has been deposited by another router.

**Syntax**

```
area <areaid> nssa translator-stab-intv <0-3600>
no area <areaid> nssa translator-stab-intv
```

**<areaid>** - Area ID.

**<0-3600>** - The range is 0 to 3600.

**no** - Disables the nssa translator's <stabilityinterval> from the specified area id.

**Default Setting**

None

**Command Mode**

Router OSPF Config

**7.3.2.12 area range**

This command creates a specified area range for a specified NSSA.

**Syntax**

```
area <areaid> range <ipaddr> <subnetmask> {summarylink | nssaexternallink}
[advertise | not-advertise]
no area <areaid> range <ipaddr> <subnetmask>
```

**<areaid>** - Area ID.

**<ipaddr>** - IP Address.

**<subnetmask>** - The subnetmask.

**summarylink** - The lsdb type. The value is summarylink or nssaexternallink

**nssaexternallink** - The lsdb type. The value is summarylink or nssaexternallink

**advertise** - Allow advertising the specified area range.

**not-advertise** - Disallow advertising the specified area range.

**<no>** - This command deletes a specified area range.

**Default Setting**

None

**Command Mode**

Router OSPF Config

### 7.3.2.13 area stub

This command creates a stub area for the specified area ID. A stub area is characterized by the fact that AS External LSAs are not propagated into the area. Removing AS External LSAs and Summary LSAs can significantly reduce the link state database of routers within the stub area.

#### Syntax

```
area <areaid> stub  
no area <areaid> stub
```

**<areaid>** - Area ID.

**<no>** - This command deletes a stub area for the specified area ID.

#### Default Setting

None

#### Command Mode

Router OSPF Config

### 7.3.2.14 area stub summarylsa

This command configures the Summary LSA mode for the stub area identified by <areaid>. The Summary LSA mode is configured as enabled.

#### Syntax

```
area <areaid> stub summarylsa  
no area <areaid> stub summarylsa
```

**<areaid>** - Area ID.

**<no>** - This command configures the default Summary LSA mode for the specified stub area.

#### Default Setting

Disabled

**Command Mode**

Router OSPF Config

**7.3.2.15 area virtual-link authentication**

This command configures the authentication type and key for the OSPF virtual interface identified by <areaid> and <neighborid>.

**Syntax**

```
area <areaid> virtual-link <neighborid> authentication [{none | {simple <key>} |  
{encrypt <key> <0-255>}}]
```

```
no area <areaid> virtual-link <neighborid> authentication
```

<areaid> - Area ID.

<neighbor> - Router ID of the neighbor.

none - No authentication.

<key> - The [key] is composed of standard displayable, non-control keystrokes from a standard 101/102-key keyboard. The authentication key must be 8 bytes or less if the authentication type is simple. If the type is encrypt, the key may be up to 256 bytes. Unauthenticated interfaces do not need an authentication key.

<0-255> - Specifies the Key ID. The range is 0 to 255.

<no> - This command configures the default authentication type for the OSPF virtual interface identified by <areaid> and <neighborid>.

**Default Setting**

The default authentication type is none.

**Command Mode**

Router OSPF Config

**7.3.2.16 area virtual-link dead-interval**

This command configures the dead interval for the OSPF virtual interface on the virtual interface identified by <areaid> and <neighborid>.

**Syntax**

```
area <areaid> virtual-link <neighborid> dead-interval <1-65535>
no area <areaid> virtual-link <neighborid> dead-interval
```

<areaid> - Area ID.

<neighbor> - Router ID of the neighbor.

<1-65535> - The range of the dead interval is 1 to 65535.

<no> - This command deletes the OSPF virtual interface from the given interface, identified by <areaid> and <neighborid>.

**Default Setting**

The default value of dead interval is 40 seconds.

**Command Mode**

Router OSPF Config

**7.3.2.17 area virtual-link hello-interval**

This command configures the hello interval for the OSPF virtual interface on the interface identified by <areaid> and <neighborid>.

**Syntax**

```
area <areaid> virtual-link <neighborid> hello-interval <1-65535>
no area <areaid> virtual-link <neighborid> hello-interval
```

<areaid> - Area ID.

<neighborid> - Router ID of the neighbor.

<1-65535> - The range of the hello interval is 1 to 65535.

<no> - This command configures the default hello interval for the OSPF virtual interface on the interface identified by <areaid> and <neighborid>.

**Default Setting**

The default value of hello interval is 10 seconds.

**Command Mode**

Router OSPF Config



### 7.3.2.18 area virtual-link retransmit-interval

This command configures the retransmit interval for the OSPF virtual interface on the interface identified by <areaid> and <neighborid>.

#### Syntax

```
area <areaid> virtual-link <neighborid> retransmit-interval <0-3600>  
no area <areaid> virtual-link <neighborid> retransmit-interval
```

<areaid> - Area ID.

<neighborid> - Router ID of the neighbor.

<0-3600> - The range of the retransmit interval is 0 to 3600.

<no> - This command configures the default retransmit interval for the OSPF virtual interface on the interface identified by <areaid> and <neighborid>.

#### Default Setting

The default value of retransmit interval is 5 seconds.

#### Command Mode

Router OSPF Config

### 7.3.2.19 area virtual-link transmit-delay

This command configures the transmit delay for the OSPF virtual interface on the virtual interface identified by <areaid> and <neighborid>.

#### Syntax

```
area <areaid> virtual-link <neighborid> transmit-delay <0-3600>  
no area <areaid> virtual-link <neighborid> transmit-delay
```

<areaid> - Area ID.

<neighbor> - Router ID of the neighbor.

<0-3600> - The range of the transmit delay is 0 to 3600.

<no> - This command configures the default transmit delay for the OSPF virtual interface on the virtual interface identified by <areaid> and <neighborid>.

**Default Setting**

The default value of hello interval is 1 second.

**Command Mode**

Router OSPF Config

**7.3.2.20 default-information originate**

This command is used to control the advertisement of default routes.

**Syntax**

```
default-information originate [always] [metric <1-16777215>] [metric-type {1 | 2}]  
no default-information originate [metric] [metric-type]
```

**[always]** - Sets the router advertise 0.0.0.0/0.0.0.0.

**metric** - The range of the metric is 1 to 16777215.

**metric type** - The value of metric type is type 1 or type 2.

**<no>** - This command configures the default advertisement of default routes.

**Default Setting**

None

**Command Mode**

Router OSPF Config

**7.3.2.21 default-metric**

This command is used to set a default for the metric of distributed routes.

**Syntax**

```
default-metric <1-16777215>  
no default-metric
```

<1-16777215> - The range of default metric is 1 to 16777215.

<no> - This command configures the default advertisement of default routes.

**Default Setting**

None

**Command Mode**

Router OSPF Config

**7.3.2.22 distance ospf**

This command sets the route preference value of OSPF in the router. Lower route preference values are preferred when determining the best route. The type of OSPF can be intra, inter, type-1, or type-2. The OSPF specification (RFC 2328) requires that preferences must be given to the routes learned via OSPF in the following order: intra < inter < type-1 < type-2.

**Syntax**

```
distance ospf {intra | inter | type1 | type2} [<preference>]  
no distance ospf {intra | inter | type1 | type2}
```

<preference> - The range for intra is 1 to 252. The range for inter is 2 to 253. The range for type1 is 3 to 254. The range for type2 is 4 to 255.

<no> - This command sets the default route preference value of OSPF in the router.

**Default Setting**

The default preference value for intra is 8. The default preference value for inter is 10. The default preference value for type 1 is 13. The default preference value for type 2 is 150.

**Command Mode**

## Router OSPF Config

**7.3.2.23 distribute-list out**

This command is used to specify the access list to filter routes received from the source protocol.

**Syntax**

```
distribute-list <1-199> out {rip | static | connected}  
no distribute-list <1-199> out {rip | static | connected}
```

**<1-199>** - The range of default list id is 1 to 199.

**<no>** - This command is used to specify the access list to filter routes received from the source protocol.

**Default Setting**

None

**Command Mode**

Router OSPF Config

**7.3.2.24 exit-overflow-interval**

This command configures the exit overflow interval for OSPF. It describes the number of seconds after entering Overflow state that a router will wait before attempting to leave the Overflow State. This allows the router to again originate non-default AS-external-LSAs. When set to 0, the router will not leave Overflow State until restarted.

**Syntax**

```
exit-overflow-interval <0-2147483647>  
no exit-overflow-interval
```

**<0-2147483647>** - The range of exit overflow interval for OSPF is 0 to 2147483674.

**<no>** - This command configures the default exit overflow interval for OSPF.

### Default Setting

The default value of exit overflow interval for OSPF is 0.

### Command Mode

Router OSPF Config

### 7.3.2.25 external-lsdb-limit

This command configures the external LSDB limit for OSPF. If the value is -1, then there is no limit. When the number of non-default AS-external-LSAs in a router's link-state database reaches the external LSDB limit, the router enters overflow state. The router never holds more than the external LSDB limit non-default AS-external-LSAs in its database. The external LSDB limit MUST be set identically in all routers attached to the OSPF backbone and/or any regular OSPF area.

<b>Syntax</b>
<b>external-lsdb-limit &lt;-1-2147483647&gt;</b> <b>no external-lsdb-limit</b>

**<-1-2147483647>** - The range of external LSDB limit for OSPF is -1 to 2147483674.

**<no>** - This command configures the default external LSDB limit for OSPF.

### Default Setting

The default value of external LSDB limit for OSPF is -1.

### Command Mode

Router OSPF Config

### 7.3.2.26 ip ospf areaid

This command sets the OSPF area to which the specified router interface belongs. Assigning

an area id, which does not exist on an interface, causes the area to be created with default values.

**Syntax**

```
ip ospf areaid {<areaid> <0-4294967295>}
```

**< areaid >** - It is an IP address, formatted as a 4-digit dotted-decimal number that uniquely identifies the area to which the interface connects.  
**<0-4294967295>** - OSPF areaid as decimal value.

**Default Setting**

None

**Command Mode**

Interface Config

**7.3.2.27 ip ospf authentication**

This command sets the OSPF Authentication Type and Key for the specified interface. The value of <type> is either none, simple or encrypt. If the type is encrypt a <keyid> in the range of 0 and 255 must be specified.

**Syntax**

```
ip ospf authentication {none | {simple <key>} | {encrypt <key> <keyid>}}  
no ip ospf authentication
```

**< key >** - It is composed of standard displayable, non-control keystrokes from a Standard 101/102-key keyboard. The authentication key must be 8 bytes or less if the authentication type is simple. If the type is encrypt, the key may be up to 256 bytes.  
**<keyid>** - The range is 0 to 255.

**Default Setting**

The default authentication type is none. The default password key is not configured. Unauthenticated interfaces do not need an authentication. The default keyid is not configured.

**Command Mode**

Interface Config

**7.3.2.28 ip ospf cost**

This command configures the cost on an OSPF interface.

**Syntax**

```
ip ospf cost <1-65535>  
no ip ospf cost
```

< 1-65535 > - The range of the cost is 1 to 65535.

<no> - This command configures the default cost on an OSPF interface.

**Default Setting**

The default cost value is 10.

**Command Mode**

Interface Config

**7.3.2.29 ip ospf dead-interval**

This command sets the OSPF dead interval for the specified interface.

**Syntax**

```
ip ospf dead-interval <1-2147483647>  
no ip ospf dead-interval
```

**< 1-2147483647 >** - It is a valid positive integer, which represents the length of time in seconds that a router's Hello packets have not been seen before its neighbor routers declare that the router is down. The value for the length of time must be the same for all routers attached to a common network. This value should be some multiple of the Hello Interval (i.e. 4).

**<no>** - This command sets the default OSPF dead interval for the specified interface.

### Default Setting

The default dead interval is 40 seconds.

### Command Mode

Interface Config

#### 7.3.2.30 ip ospf hello -interval

This command sets the OSPF hello interval for the specified interface.

<b>Syntax</b>
<b>ip ospf hello-interval &lt;1-65535&gt;</b> <b>no ip ospf hello-interval</b>

**< 1-65535 >** - Is a valid positive integer, which represents the length of time in seconds. The value for the length of time must be the same for all routers attached to a network.

**<no>** - This command sets the default OSPF hello interval for the specified interface.

### Default Setting

The default hello interval is 10 seconds.

### Command Mode

Interface Config

#### 7.3.2.31 ip ospf priority

This command sets the OSPF priority for the specified router interface



**Syntax**

```
ip ospf priority <0-255>  
no ip ospf priority
```

< **0-255** > - The range of the priority value is 0 to 255. A value of '0' indicates that the router is not eligible to become the designated router on this network.

<**no**> - This command sets the default OSPF priority for the specified interface.

**Default Setting**

The default priority value is 1. It is the highest router priority.

**Command Mode**

Interface Config

**7.3.2.32 ip ospf retransmit-interval**

This command sets the OSPF retransmit Interval for the specified interface. The retransmit interval is specified in seconds.

**Syntax**

```
ip ospf retransmit-interval <0-3600>  
no ip ospf retransmit-interval
```

< **0-3600** > - The value is the number of seconds between link-state advertisement retransmissions for adjacencies belonging to this router interface. This value is also used when retransmitting database and link-state request packets.

<**no**> - This command sets the default OSPF retransmit Interval for the specified interface.

**Default Setting**

The default retransmit interval is 5 seconds.

### Command Mode

Interface Config

#### 7.3.2.33 ip ospf transmit-delay

This command sets the OSPF Transmit Delay for the specified interface. The transmit delay is specified in seconds. In addition, it sets the estimated number of seconds it takes to transmit a link state update packet over this interface.

<b>Syntax</b>
---------------

<pre>ip ospf transmit-delay &lt;1-3600&gt; no ip ospf transmit-delay</pre>
--

< 1-3600 > - The range of transmit delay is 1 to 3600.

<no> - This command sets the default OSPF Transit Delay for the specified interface.

### Default Setting

The default transmit delay is 1 second.

### Command Mode

Interface Config

#### 7.3.2.34 ip ospf mtu-ignore

This command disables OSPF maximum transmission unit (MTU) mismatch detection. OSPF Database Description packets specify the size of the largest IP packet that can be sent without fragmentation on the interface. When a router receives a Database Description packet, it examines the MTU advertised by the neighbor. By default, if the MTU is larger than the router can accept, the Database Description packet is rejected and the OSPF adjacency is not established.

<b>Syntax</b>
---------------

```
ip ospf mtu-ignore  
no ip ospf mtu-ignore
```

<no> - This command enables the OSPF MTU mismatch detection.

#### Default Setting

Enabled.

#### Command Mode

Interface Config

#### 7.3.2.35 router-id

This command sets a 4-digit dotted-decimal number uniquely identifying the router ospf id.

#### Syntax

```
router-id <ipaddress>
```

< ipaddress > - IP Address.

#### Default Setting

None.

#### Command Mode

Router OSPF Config

#### 7.3.2.36 redistribute

This command configures OSPF protocol to redistribute routes from the specified source protocol/routers.

**Syntax**

```
redistribute {rip | static | connected} [metric <0-16777214>] [metric-type {1 | 2}] [tag <0-4294967295>] [subnets]
```

```
no redistribute {rip | static | connected} [metric] [metric-type] [tag] [subnets]
```

<0-16777215> - The range of metric is 0 to 16777214.

<0-4294967295> - The range of tag is 0 to 4294967295.

**Default Setting**

The default value of metric is unspecified. The default value of metric type is 2. The default value of tag is 0.

**Command Mode**

Router OSPF Config

**7.3.2.37 maximum-paths**

This command sets the number of paths that OSPF can report for a given destination where <maxpaths> is platform dependent.

**Syntax**

```
maximum-paths <1-2>
```

```
no maximum-paths
```

<1-2> - The maximum number of paths that OSPF can report for a given destination. The range of the value is 1 to 1.

**Default Setting**

The default value is 1.

**Command Mode**

Router OSPF Config.

### 7.3.2.38 timers spf

This command configures the SPF delay time and hold time. The valid range for both parameters is 0-65535 seconds.

**Syntax**

```
timers spf <0-65535> <0-65535>
```

**Default Setting**

Delay-time—5

Hold-time—10

**Command Mode**

Router OSPF Config.

## 7.4 Bootp/DHCP Relay Commands

### 7.4.1 show bootpdhcprelay

This command displays the BootP/DHCP Relay information.

**Syntax**

```
show bootpdhcprelay
```

**Default Setting**

None

**Command Mode**

Privileged Exec, User Exec

**Display Message**

**Maximum Hop Count:** Is the maximum allowable relay agent hops.

**Minimum Wait Time (Seconds)** Is the minimum wait time.

**Admin Mode** Represents whether relaying of requests is enabled or disabled.

**Server IP Address** Is the IP Address for the BootP/DHCP Relay server.

**Circuit Id Option Mode** Is the DHCP circuit Id option which may be enabled or disabled.

**Requests Received** Is the number of requests received.

**Requests Relayed** Is the number of requests relayed.

**Packets Discarded** Is the number of packets discarded.

#### 7.4.2 bootpdhcprelay cidoptmode

This command enables the circuit ID option mode for BootP/DHCP Relay on the system.

**Syntax**

```
bootpdhcprelay cidoptmode
no bootpdhcprelay cidoptmode
```

**Default Setting**

Disabled

**Command Mode**

Global Config

#### 7.4.3 bootpdhcprelay enable

This command enables the forwarding of relay requests for BootP/DHCP Relay on the system.

**Syntax**

```
bootpdhcprelay enable
no bootpdhcprelay enable
```

**no** - Disable the forwarding of relay requests for BootP/DHCP Relay on the system.

**Default Setting**

Disabled

**Command Mode**

Global Config

#### 7.4.4 bootpdhcprelay maxhopcount

This command configures the maximum allowable relay agent hops for BootP/DHCP Relay on the system.

**Syntax**

```
bootpdhcprelay maxhopcount <1-16>
no bootpdhcprelay maxhopcount
```

**<count>** - The range of maximum hop count is 1 to 16.

**no** - Set the maximum hop count to 4.

### Default Setting

The default value is 4.

### Command Mode

Global Config

#### 7.4.5 bootpdhcprelay minwaittime

This command configures the minimum wait time in seconds for BootP/DHCP Relay on the system. When the BOOTP relay agent receives a BOOTREQUEST message, it may use the seconds-since-client-began-booting field of the request as a factor in deciding whether to relay the request or not.

##### Syntax

```
bootpdhcprelay minwaittime <0-100>  
no bootpdhcprelay minwaittime
```

**<seconds>** - The range of minimum wait time is 0 to 100.

**no** - Set the minimum wait time to 0 seconds.

### Default Setting

The default value is 0.

### Command Mode

Global Config

#### 7.4.6 bootpdhcprelay serverip

This command configures the server IP Address for BootP/DHCP Relay on the system.

##### Syntax

```
bootpdhcprelay serverip <ipaddr>  
no bootpdhcprelay serverip
```

**<ipaddr>** - The IP address of the BootP/DHCP server.

**no** - Clear the IP address of the BootP/DHCP server.

**Default Setting**

None

**Command Mode**

Global Config

**7.5 Domain Name Server Relay Commands****7.5.1 Show Commands****7.5.1.1 show hosts**

This command displays the static host name-to-address mapping table.

**Syntax**

```
show hosts
```

**Default Setting**

None

**Command Mode**

Privileged Exec

**Display Message****Domain Name List:** Domain Name.**IP Address:** IP address of the Host.**7.5.1.2 show dns**

This command displays the configuration of the DNS server.

**Syntax**

```
show dns
```



**Default Setting**

None

**Command Mode**

Privileged Exec

**Display Message**

**Domain Lookup Status:** Enable or disable the IP Domain Naming System (DNS)-based host name-to-address translation function.

**Default Domain Name:** The default domain name that will be used for querying the IP address of a host.

**Domain Name List:** A list of domain names that will be used for querying the IP address of a host.

**Name Server List:** A list of domain name servers.

**Request:** Number of the DNS query packets been sent.

**Response:** Number of the DNS response packets been received.

**7.5.1.3 show dns cache**

This command displays all entries in the DNS cache table.

<b>Syntax</b>
---------------

<b>show dns cache</b>
-----------------------

**Default Setting**

None

**Command Mode**

Privileged Exec

**Display Message**

**Domain Name List:** Domain Name

**IP Address:** IP address of the corresponding domain name.

**TTL:** Time in seconds that this entry will remain in the DNS cache table

**Flag:** Indicates if this entry is reliable. A value of 8 is not as reliable as a value of 10.

## 7.5.2 Configuration Commands

### 7.5.2.1 ip hosts

This command creates a static entry in the DNS table that maps a host name to an IP address.

<b>Syntax</b>
---------------

<pre>ip host &lt;name&gt; &lt;ipaddr&gt; no ip host &lt;name&gt;</pre>
--

<name> - Host name.

<ipaddr> - IP address of the host.

<no> - Remove the corresponding name to IP address mapping entry.

#### Default Setting

None

#### Command Mode

Global Mode

### 7.5.2.2 clear hosts

This command clears the entire static host name-to-address mapping table.

<b>Syntax</b>
---------------

<pre>clear hosts</pre>
------------------------

#### Default Setting

None

#### Command Mode

Privileged Exec

### 7.5.2.3 ip domain-name

This command defines the default domain name to be appended to incomplete host names (i.e., host names passed from a client are not formatted with dotted notation).

<b>Syntax</b>
---------------

<b>ip domain-name &lt;name&gt;</b> <b>no ip domain-name &lt;name&gt;</b>
---

**<name>** - Default domain name used to complete unqualified host names. Do not include the initial period that separates an unqualified name from the domain name. (Range: 1-64 characters)

#### Default Setting

None

#### Command Mode

Global Mode

### 7.5.2.4 ip domain-list

This command defines the domain name that can be appended to incomplete host names (i.e., host names passed from a client are not formatted with dotted notation). The domain name table can contain maximum 6 entries.

<b>Syntax</b>
---------------

<b>ip domain-list &lt;name&gt;</b> <b>no ip domain-list &lt;name&gt;</b>
---

**<name>** - Default domain name used to complete unqualified host names. Do not include the initial period that separates an unqualified name from the domain name. (Range: 1-64 characters)

**Note** - When an incomplete host name is received by the DNS server on this switch, it will work through the domain name list, append each domain name in the list to the host name, and check with the specified name servers for a match. If there is no domain name list, the domain name specified with the "*ip domain-name*" command is used. If there is a

domain name list, the default domain name is not used.

**Default Setting**

None

**Command Mode**

Global Mode

**7.5.2.5 ip name-server**

This command specifies the address of one or more domain name servers to use for name-to-address resolution. There are maximum 6 entries in the Domain Name Server Table.

**Syntax**

```
ip name-server <ipaddr>  
no ip name-server <ipaddr>
```

< ipaddr > - IP address of the Domain Name Servers.

<no> - Remove the corresponding Domain Name Server entry from the table.

**Note** - The listed name servers are queried in the specified sequence until a response is received, or the end of the list is reached with no response.

**Default Setting**

None

**Command Mode**

Global Mode

**7.5.2.6 ip domain-lookup**

This command enables the IP Domain Naming System (DNS)-based host name-to-address translation.

**Syntax**

```
ip domain-lookup  
no ip domain-lookup
```

**<no>** - This command disables the IP Domain Naming System (DNS)-based host name-to-address translation.

**Default Setting**

None

**Command Mode**

Global Mode

**7.5.2.7 clear domain-list**

This command clears all entries in the domain name list table.

**Syntax**

```
clear domain-list
```

**Default Setting**

None

**Command Mode**

Privileged Exec

**7.5.2.8 clear dns**

This command sets the DNS configuration to default value.

**Syntax**

```
clear dns
```

**Default Setting**

None

**Command Mode**

Privileged Exec

**7.5.2.9 clear dns cache**

This command clears all entries in the DNS cache table.

**Syntax**

```
clear dns cache
```

**Default Setting**

None

**Command Mode**

Privileged Exec

**7.5.2.10 clear dns counter**

This command clears the statistics of all entries in the DNS cache table.

**Syntax**

```
clear dns counter
```

**Default Setting**

None

**Command Mode**

Privileged Exec

## 7.6 Routing Information Protocol (RIP) Commands

### 7.6.1 Show Commands

#### 7.6.1.1 show ip rip

This command displays information relevant to the RIP router.

<b>Syntax</b>
---------------

<code>show ip rip</code>
--------------------------

#### Default Setting

None

#### Command Mode

Privileged Exec

#### Display Message

**RIP Admin Mode:** Select enable or disable from the pulldown menu. If you select enable RIP will be enabled for the switch. The default is disabled.

**Split Horizon Mode:** Select none, simple or poison reverse from the pulldown menu. Split horizon is a technique for avoiding problems caused by including routes in updates sent to the router from which the route was originally learned. The options are: None - no special processing for this case. Simple - a route will not be included in updates sent to the router from which it was learned. Poisoned reverse - a route will be included in updates sent to the router from which it was learned, but the metric will be set to infinity. The default is simple

**Auto Summary Mode:** Select enable or disable from the pulldown menu. If you select enable groups of adjacent routes will be summarized into single entries, in order to reduce the total number of entries. The default is enabled.

**Host Routes Accept Mode:** Select enable or disable from the pulldown menu. If you select enable the router will be accept host routes. The default is enabled.

**Global Route Changes:** The number of route changes made to the IP Route Database by RIP. This does not include the refresh of a route's age.

**Global queries:** The number of responses sent to RIP queries from other systems. Default Metric Sets a default for the metric of redistributed routes. This field displays the default metric if one has already been set or blank if not configured earlier. The valid values are (1 to 15).

**Default Metric:** Sets a default for the metric of redistributed routes. This field displays the default metric if one has already been set or blank if not configured earlier. The valid values are (1 to 15).

**Default Route Advertise:** The default route.

### 7.6.1.2 show ip rip interface

This command displays information related to a particular RIP interface.

<b>Syntax</b>
---------------

<b>show ip rip interface &lt;slot/port&gt;</b>
--

< slot/port > - Interface number

#### Default Setting

None

#### Command Mode

Privileged Exec

#### Display Message

**Interface:** Valid slot and port number separated by forward slashes. This is a configured value.

**IP Address:** The IP source address used by the specified RIP interface. This is a configured value.

**Send version:** The RIP version(s) used when sending updates on the specified interface. The types are none, RIP-1, RIP-1c, and RIP-2. This is a configured value.

**Receive version:** The RIP version(s) allowed when receiving updates from the specified interface. The types are none, RIP-1, RIP-2, Both. This is a configured value.

**RIP Admin Mode:** RIP administrative mode of router RIP operation; enable, disable it. This is a configured value.

**Link State:** Indicates whether the RIP interface is up or down. This is a configured value.

**Authentication Type:** The RIP Authentication Type for the specified interface. The types are none, simple, and encrypt. This is a configured value.

**Authentication Key:** 16 alpha-numeric characters for authentication key when uses simple or encrypt authentication.

**Authentication Key ID:** It is a Key ID when uses MD5 encryption for RIP authentication.

**Default Metric:** A number which represents the metric used for default routes in RIP updates originated on the specified interface. This is a configured value. The following information will be invalid if the link state is down.

**Bad Packets Received:** The number of RIP response packets received by the RIP process which were subsequently discarded for any reason.

**Bad Routes Received:** The number of routes contained in valid RIP packets that were ignored for any reason.

**Updates Sent:** The number of triggered RIP updates actually sent on this interface.



### 7.6.1.3 show ip rip interface brief

This command displays general information for each RIP interface. For this command to display successful results routing must be enabled per interface (i.e. ip rip).

<b>Syntax</b>
---------------

<b>show ip rip interface brief</b>
------------------------------------

#### Default Setting

None

#### Command Mode

Privileged Exec

#### Display Message

**Interface:** Valid slot and port number separated by forward slashes.

**IP Address:** The IP source address used by the specified RIP interface.

**Send Version:** The RIP version(s) used when sending updates on the specified interface. The types are none, RIP-1, RIP-1c, RIP-2.

**Receive Version:** The RIP version(s) allowed when receiving updates from the specified interface. The types are none, RIP-1, RIP-2, Both

**RIP Mode:** RIP administrative mode of router RIP operation; enable, disable it.

**Link State:** The mode of the interface (up or down).

## 7.6.2 Configuration Commands

### 7.6.2.1 enable rip

This command resets the default administrative mode of RIP in the router (active).

<b>Syntax</b>
---------------

<b>enable</b> <b>no enable</b>
-----------------------------------

**no** - This command sets the administrative mode of RIP in the router to inactive.

#### Default Setting

Enable

**Command Mode**

Router RIP Config

**7.6.2.2 ip rip**

This command enables RIP on a router interface.

**Syntax**

```
ip rip
no ip rip
```

**no** - This command disables RIP on a router interface.

**Default Setting**

Disabled

**Command Mode**

Interface Config

**7.6.2.3 auto-summary**

This command enables the RIP auto-summarization mode.

**Syntax**

```
auto-summary
no auto-summary
```

**no** - This command disables the RIP auto-summarization mode.

**Default Setting**

Disable

**Command Mode**

Router RIP Config

**7.6.2.4 default-information originate**

This command is used to set the advertisement of default routes.

**Syntax**

```
default-information originate  
no default-information originate
```

**no** - This command is used to cancel the advertisement of default routes.

**Default Setting**

Not configured

**Command Mode**

Router RIP Config

**7.6.2.5 default-metric**

This command is used to set a default for the metric of distributed routes.

**Syntax**

```
default-metric <1-15>  
no default-metric
```

**<1 - 15>** - a value for default-metric.

**no** - This command is used to reset the default metric of distributed routes to its default value.

**Default Setting**

Not configured

**Command Mode**

Router RIP Config

**7.6.2.6 distance rip**

This command sets the route preference value of RIP in the router. Lower route preference values are preferred when determining the best route.

**Syntax**

```
distance rip <1-255>  
no distance rip
```

**<1 - 255>** - the value for distance.

**no** - This command sets the default route preference value of RIP in the router.

**Default Setting**

15

**Command Mode**

Router RIP Config

**7.6.2.7 hostrouteaccept**

This command enables the RIP hostroutesaccept mode.

**Syntax**

```
hostrouteaccept  
no hostrouteaccept
```

**no** - This command disables the RIP hostroutesaccept mode.

**Default Setting**

Enable

**Command Mode**

Router RIP Config

**7.6.2.8 split-horizon**

This command sets the RIP split horizon mode. **None mode** will not use RIP split horizon mode. **Simple mode** will be that a route is not advertised on the interface over which it is learned. **Poison mode** will be that routes learned over this interface should be re-advertised on the interface with a metric of infinity (16).

**Syntax**

```
split-horizon {none | simple | poison}  
no split-horizon
```

**none** - This command sets without using RIP split horizon mode.

**simple** - This command sets to use simple split horizon mode.

**poison** - This command sets to use poison reverse mode.

**no** - This command cancel to set the RIP split horizon mode and sets none mode.

**Default Setting**

Simple

**Command Mode**

Router RIP Config

**7.6.2.9 distribute-list**

This command is used to specify the access list to filter routes received from the source protocol. Source protocols have OSPF, Static, and Connected.

**Syntax**

```
istribute-list <1-199> out {ospf | static | connected}
no distribute-list <1-199> out {ospf | static | connected}
```

**<1 - 199>** - Access List ID value. The Access List filters the routes to be redistributed by the source protocol.

**no** - This command is used to cancel the access list to filter routes received from the source protocol.

### Default Setting

0

### Command Mode

Router RIP Config

### 7.6.2.10 redistribute

This command configures RIP protocol to redistribute routes from the specified source protocol/routers. There are five possible match options. When you submit the command `redistribute ospf match <matchtype>` the match-type or types specified are added to any match types presently being redistributed. Internal routes are redistributed by default. Source protocols have OSPF, Static, and Connected. Match types will have internal, external 1, external 2, nssa-external 1, and nssa-external 2.

#### Syntax

##### ***Format for OSPF as source protocol:***

```
redistribute ospf [metric <1-15>] [match [internal] [external 1] [external 2]
[nssa-external 1] [nssa-external 2]]
```

##### ***Format for other source protocols:***

```
redistribute {static | connected} [metric <1-15>]
no redistribute {ospf | static | connected} [metric] [match [internal] [external 1]
[external 2] [nssa-external 1] [nssa-external 2]]
```

**<1 - 15>** - a value for metric.

**no** - This command de-configures RIP protocol to redistribute routes from the specified source protocol/routers.

### Default Setting

Metric - not-configured  
Match - internal

**Command Mode**

Router RIP Config

**7.6.2.11 ip rip authentication**

This command sets the RIP Version 2 Authentication Type and Key for the specified interface. The value of <type> is either **none**, **simple**, or **encrypt**.

The value for authentication key [key] must be 16 bytes or less. The [key] is composed of standard displayable, non-control keystrokes from a Standard 101/102-key keyboard. If the value of <type> is encrypt, a keyid in the range of 0 and 255 must be specified.

**Syntax**

```
ip rip authentication {none | {simple <key>} | {encrypt <key> <keyid>}}  
no ip rip authentication
```

**none** - This command uses no authentication.

**simple** - This command uses simple authentication for RIP authentication .

**encrypt** - This command uses MD5 encryption for RIP authentication.

**<key>** - 16 alpha-numeric characters to be used for authentication key.

**<keyid>** - a value in the range of 0 – 255 to be used for MD5 encryption.

**no** - This command sets the default RIP Version 2 Authentication Type.

**Default Setting**

None

**Command Mode**

Interface Config

**7.6.2.12 ip rip receive version**

This command configures the interface to allow RIP control packets of the specified version(s) to be received.

The value for <mode> is one of: **rip1** to receive only RIP version 1 formatted packets, **rip2** for RIP version 2, **both** to receive packets from either format, or **none** to not allow any RIP control packets to be received

**Syntax**

```
ip rip receive version {rip1 | rip2 | both | none}
no ip rip receive version
```

**no** - This command configures the interface to allow RIP control packets of the default version(s) to be received.

**Default Setting**

Both

**Command Mode**

Interface Config

**7.6.2.13 ip rip send version**

This command configures the interface to allow RIP control packets of the specified version to be sent.

The value for <mode> is one of: **rip1** to broadcast RIP version 1 formatted packets, **rip1c** (RIP version 1 compatibility mode) which sends RIP version 2 formatted packets via broadcast, **rip2** for sending RIP version 2 using multicast, or **none** to not allow any RIP control packets to be sent.

**Syntax**

```
ip rip send version {rip1 | rip1c | rip2 | none}
no ip rip send version
```

**no** - This command configures the interface to allow RIP control packets of the default version to be sent.

**Default Setting**



Rip2

**Command Mode**

Interface Config

## 7.7 Router Discovery Protocol Commands

### 7.7.1 show ip irdp

This commands displays the router discovery information for all interfaces, or a specified interface.

**Syntax**

```
show ip irdp {<slot/port> | all}
```

<slot/port> - Show router discovery information for the specified interface.

<all> - Show router discovery information for all interfaces.

**Default Setting**

None

**Command Mode**

Privileged Exec, User Exec

**Display Message**

**Ad Mode** Displays the advertise mode which indicates whether router discovery is enabled or disabled on this interface.

**Advertise Address:** Addresses to be used to advertise the router for the interface.

**Max Int** Displays the maximum advertise interval which is the maximum time allowed between sending router advertisements from the interface in seconds.

**Min Int** Displays the minimum advertise interval which is the minimum time allowed between sending router advertisements from the interface in seconds.

**Hold Time** Displays advertise holdtime which is the value of the holdtime field of the router advertisement sent from the interface in seconds.

**Preferences** Displays the preference of the address as a default router address, relative to other router addresses on the same subnet.

### 7.7.2 ip irdp

This command enables Router Discovery on an interface.

**Syntax**

```
ip irdp
no ip irdp
```

<no> - Disable Router Discovery on an interface.

#### Default Setting

Disabled

#### Command Mode

Interface Config

### 7.7.3 ip irdp broadcast

This command configures the address to be used to advertise the router for the interface.

#### Syntax

```
ip irdp broadcast
no ip irdp broadcast
```

**broadcast** - The address used is 255.255.255.255.

**no** - The address used is 224.0.0.1.

#### Default Setting

The default address is 224.0.0.1

#### Command Mode

Interface Config

### 7.7.4 ip irdp holdtime

This commands configures the value, in seconds, of the holdtime field of the router advertisement sent from this interface.

#### Syntax

```
ip irdp holdtime < maxadvertinterval-9000 >
no ip irdp holdtime
```

< maxadvertinterval-9000 > The range is the maxadvertinterval to 9000 seconds.

**no** - This command configures the default value, in seconds, of the holdtime field of the router advertisement sent from this interface.

### Default Setting

The default value is  $3 * \text{maxadvertinterval} (600) = 1800$ .

### Command Mode

Global Config

#### 7.7.5 ip irdp maxadvertinterval

This command configures the maximum time, in seconds, allowed between sending router advertisements from the interface.

##### Syntax

```
ip irdp maxadvertinterval < minadvertinterval-1800 >  
no ip irdp maxadvertinterval
```

< minadvertinterval-1800 > - The range is 4 to 1800 seconds.

**no** - This command configures the default maximum time, in seconds.

### Default Setting

The default value is 600.

### Command Mode

Global Config

#### 7.7.6 ip irdp minadvertinterval

This command configures the minimum time, in seconds, allowed between sending router advertisements from the interface.

##### Syntax

```
ip irdp minadvertinterval < 3-maxadvertinterval >  
no ip irdp minadvertinterval
```

**< 3-maxadvertinterval>** - The range is 3 to maxadvertinterval seconds.

**no** - This command sets the minimum time to 450.

### Default Setting

The default value is 450.

### Command Mode

Global Config

#### 7.7.7 ip irdp preference

This command configures the preferability of the address as a default router address, relative to other router addresses on the same subnet.

<b>Syntax</b>
---------------

<b>ip irdp preference &lt; -2147483648-2147483647&gt;</b> <b>no ip irdp preference</b>
---

**< -2147483648-2147483647>** - The range is -2147483648 to 2147483647.

**no** - This command sets the preference to 0.

### Default Setting

The default value is 0.

### Command Mode

Global Config

## 7.8 VLAN Routing Commands

### 7.8.1 show ip vlan

This command displays the VLAN routing information for all VLANs with routing enabled in the system.

<b>Syntax</b>
---------------

<b>show ip vlan</b>
---------------------

**Default Setting**

None

**Command Mode**

Privileged Exec, User Exec

**Display Message**

**MAC Address used by Routing VLANs** Is the MAC Address associated with the internal bridgerouter interface (IBRI). The same MAC Address is used by all VLAN routing interfaces. It will be displayed above the per-VLAN information.

**VLAN ID** Is the identifier of the VLAN.

**Logical Interface** Indicates the logical slot/port associated with the VLAN routing interface.

**IP Address** Displays the IP Address associated with this VLAN.

**Subnet Mask** Indicates the subnet mask that is associated with this VLAN.

## 7.8.2 vlan routing

This command creates routing on a VLAN.

**Syntax**

```
vlan routing <vlanid>  
no vlan routing <vlanid>
```

**<vlanid>** - The range is 1 to 3965.

**no** - Delete routing on a VLAN.

**Default Setting**

None

**Command Mode**

VLAN Database

## 7.9 Virtual Router Redundancy Protocol (VRRP) Commands

### 7.9.1 Show Commands

#### 7.9.1.1 show ip vrrp

This command displays whether VRRP functionality is enabled or disabled. It also displays

some global parameters which are required for monitoring.

**Syntax**

```
show ip vrrp
```

**Default Setting**

None

**Command Mode**

Privileged Exec, User Exec

**Display Message**

**Admin Mode** Displays the administrative mode for VRRP functionality on the switch.

**Router Checksum Errors** Represents the total number of VRRP packets received with an invalid VRRP checksum value.

**Router Version Errors** Represents the total number of VRRP packets received with Unknown or unsupported version number.

**Router VRID Errors** Represents the total number of VRRP packets received with invalid VRID for this virtual router.

**7.9.1.2 show ip vrrp brief**

This command displays information about each virtual router configured on the switch.

**Syntax**

```
show ip vrrp brief
```

**Default Setting**

None

**Command Mode**

Privileged Exec, User Exec

**Display Message**

**Interface** Valid slot and port number separated by forward slashes.

**VRID** Represents the router ID of the virtual router.

**IP Address** Is the IP Address that was configured on the virtual router

**Mode** Represents whether the virtual router is enabled or disabled.

**State** Represents the state (Master/backup) of the virtual router.

### 7.9.1.3 show ip vrrp interface

This command displays all configuration information of a virtual router configured on a specific interface. Note that the information will be displayed only when the IP address of the specific interface is configured.

**Syntax**

```
show ip vrrp interface <slot/port> [ <vrid>]
```

<slot/port> - Valid slot and port number separated by forward slashes.

<vrid> - Virtual router ID.

**Default Setting**

None

**Command Mode**

Privileged Exec, User Exec

**Display Message**

**VRID** Represents the router ID of the virtual router.

**Primary IP Address** This field represents the configured IP Address for the Virtual router.

**VMAC address** Represents the VMAC address of the specified router.

**Authentication type** Represents the authentication type for the specific virtual router.

**Priority** Represents the priority value for the specific virtual router.

**Advertisement interval** Represents the advertisement interval for the specific virtual router.

**Pre-Empt Mode** Is the preemption mode configured on the specified virtual router.

**Administrative Mode** Represents the status (Enable or Disable) of the specific router.

**State** Represents the state (Master/backup) of the specific virtual router

### 7.9.1.4 show ip vrrp interface stats

This command displays the statistical information about each virtual router configured on the switch.

**Syntax**

```
show ip vrrp interface stats <slot/port> [ <vrid>]
```

<slot/port> - Valid slot and port number separated by forward slashes.

<vrid> - Virtual router ID.

**Default Setting**

None

**Command Mode**

Privileged Exec, User Exec

### Display Message

**VRID** Represents the router ID of the virtual router.

**Uptime** Is the time that the virtual router has been up, in days, hours, minutes and seconds.

**Protocol** Represents the protocol configured on the interface.

**State Transitioned to Master** Represents the total number of times virtual router state has changed to MASTER.

**Advertisement Received** Represents the total number of VRRP advertisements received by this virtual router.

**Advertisement Interval Errors** Represents the total number of VRRP advertisements received for which advertisement interval is different than the configured value for this virtual router.

**Authentication Failure** Represents the total number of VRRP packets received that don't pass the authentication check.

**IP TTL errors** Represents the total number of VRRP packets received by the virtual router with IP TTL (time to live) not equal to 255.

**Zero Priority Packets Received** Represents the total number of VRRP packets received by virtual router with a priority of '0'.

**Zero Priority Packets Sent** Represents the total number of VRRP packets sent by the virtual router with a priority of '0'

**Invalid Type Packets Received** Represents the total number of VRRP packets received by the virtual router with invalid 'type' field.

**Address List Errors** Represents the total number of VRRP packets received for which address list does not match the locally configured list for the virtual router.

**Invalid Authentication Type** Represents the total number of VRRP packets received with unknown authentication type.

**Authentication Type Mismatch** Represents the total number of VRRP advertisements received for which 'auth type' not equal to locally configured one for this virtual router.

**Packet Length Errors** Represents the total number of VRRP packets received with packet length less than length of VRRP header.

## 7.9.2 Configuration Commands

### 7.9.2.1 ip vrrp

This command enables the administrative mode of VRRP in the router.

<b>Syntax</b>
---------------

<pre>ip vrrp no ip vrrp</pre>
-------------------------------

### Default Setting

Disabled



**Command Mode**

Global Config

This command sets the virtual router ID on an interface for Virtual Router configuration in the router.

**Syntax**

```
ip vrrp <1-255>  
no ip vrrp <1-255>
```

<1-255> - The range of virtual router ID is 1 to 255.

<no> - This command removes all VRRP configuration details of the virtual router configured on a specific interface.

**Default Setting**

None

**Command Mode**

Interface Config

**7.9.2.2 ip vrrp ip**

This commands also designates the configured virtual router IP address as a secondary IP address on an interface.

**Syntax**

```
ip vrrp <1-255> ip <addr> [secondary]  
no ip vrrp <1-255> ip <addr> [secondary]
```

<1-255> - The range of virtual router ID is 1 to 255.

<addr> - Secondary IP address of the router ID.

<no> - This command removes all VRRP configuration details of the virtual router configured on a specific interface.

**Default Setting**

None

### Command Mode

Interface Config

#### 7.9.2.3 ip vrrp mode

This command enables the virtual router configured on the specified interface. Enabling the status field starts a virtual router.

##### Syntax

```
ip vrrp <1-255> mode  
no ip vrrp <1-255> mode
```

<1-255> - The range of virtual router ID is 1 to 255.

<no> - Disable the virtual router configured on the specified interface. Disabling the status field stops a virtual router.

### Default Setting

Disabled

### Command Mode

Interface Config

#### 7.9.2.4 ip vrrp authentication

This command sets the authorization details value for the virtual router configured on a specified interface.

##### Syntax

```
ip vrrp <1-255> authentication <key>  
no ip vrrp <1-255> authentication
```

<1-255> - The range of virtual router ID is 1 to 255.

<key> - A text password used for authentication.

<no> - This command sets the default authorization details value for the virtual router configured on a specified interface.

**Default Setting**

no authentication

**Command Mode**

Interface Config

**7.9.2.5 ip vrrp preempt**

This command sets the preemption mode value for the virtual router configured on a specified interface.

**Syntax**

```
ip vrrp <1-255> preempt
no ip vrrp <1-255> preempt
```

<1-255> - The range of virtual router ID is 1 to 255.

<no> - This command sets the default preemption mode value for the virtual router configured on a specified interface.

**Default Setting**

Enabled

**Command Mode**

Interface Config

**7.9.2.6 ip vrrp priority**

This command sets the priority value for the virtual router configured on a specified interface.

**Syntax**

```
ip vrrp <1-255> priority <1-255>
no ip vrrp <1-255> priority
```

<1-255> - The range of virtual router ID is 1 to 255.

<1-254> - The range of priority is 1 to 255.

<no> - This command sets the default priority value for the virtual router configured on a

specified interface.

### Default Setting

The default priority value is 100.

### Command Mode

Interface Config

#### 7.9.2.7 ip vrrp timers advertise

This command sets the advertisement value for a virtual router in seconds.

<b>Syntax</b>
---------------

<pre>ip vrrp &lt;1-255&gt; timers advertise &lt;1-255&gt;</pre>
---

<pre>ip vrrp &lt;1-255&gt; timers advertise</pre>
---

<1-255> - The range of virtual router ID is 1 to 255.

< 1-255 > - The range of advertisement interval is 1 to 255.

<no> - This command sets the default advertisement value for a virtual router.

### Default Setting

The default value of advertisement interval is 1.

### Command Mode

Interface Config

## 7.10 DHCP Filtering Commands

You can configure the DHCP Filtering feature as a security measure against unauthorized DHCP servers. DHCP filtering works by allowing you to configure each port as either a trusted port or an untrusted port. To optimize the DHCP filtering feature, configure the port that is connected to an authorized DHCP server on your network as a trusted port. Any DHCP responses received on a trusted port are forwarded. Make sure that all other ports are untrusted so that any DHCP (or BootP) responses received are discarded.

You can configure DHCP filtering on physical ports and LAGs. DHCP filtering is not operable on VLAN interfaces.

## 7.10.1 Show Commands

### 7.10.1.1 show ip dhcp filtering

This command displays the DHCP filtering configuration.

<b>Syntax</b>
---------------

<b>show ip dhcp filtering</b>
-------------------------------

#### Default Setting

None

#### Command Mode

Privileged Exec

#### Display Message

**Interface:** Specifies the interface by slot/port.

**Trusted:** Indicates whether the interface is trusted or untrusted.

## 7.10.2 Configuration Commands

### 7.10.2.1 ip dhcp filtering

This command enables DHCP filtering globally.

<b>Syntax</b>
---------------

<b>ip dhcp filtering</b> <b>no ip dhcp filtering</b>
---

**no** - This command disables DHCP filtering globally

#### Default Setting

Disabled

#### Command Mode

Global Config

### 7.10.2.2 ip dhcp filtering trust

This command configures an interface as trusted.

<b>Syntax</b>
---------------

<pre>ip dhcp filtering trust noip dhcp filtering trust</pre>
--

**no** - This command returns an interface to the default value for DHCP filtering.

#### Default Setting

Untrusted

#### Command Mode

Interface Config

## 8 IP Multicast Commands

### 8.1 Distance Vector Multicast Routing Protocol (DVMRP) Commands

This section provides a detailed explanation of the DVMRP commands. The commands are divided into the following different groups:

Show commands are used to display device settings, statistics and other information. Configuration commands are used to configure features and options of the switch. For every configuration command there is a show command that will display the configuration setting.

#### 8.1.1 Show Commands

##### 8.1.1.1 show ip dvmrp

This command displays the system-wide information for DVMRP

<b>Syntax</b>
---------------

<code>show ip dvmrp</code>
----------------------------

#### Default Setting

None

#### Command Mode

Privileged Exec

User EXEC

Admin Mode This field indicates whether DVMRP is enabled or disabled. This is a configured value.

#### Display Message

**Admin Mode** Enable or disable DVMRP function.

**Version** This field indicates the version of DVMRP being used.

**Total Number of Routes** This field indicates the number of routes in the DVMRP routing table.

**Reachable Routes** This field indicates the number of entries in the routing table with non-infinitemetrics. The following fields are displayed for each interface.

**Slot/Port** Valid slot and port number separated by forward slashes.

**Interface Mode** This field indicates the mode of this interface. Possible values are Enabled and Disabled.

**State** This field indicates the current state of DVMRP on this interface. Possible values are Operational or Non-Operational.

##### 8.1.1.2 show ip dvmrp interface

This command displays the interface information for DVMRP on the specified interface.

**Syntax**

```
show ip dvmrp interface <slot/port>
```

<slot/port> - Valid slot and port number separated by forward slashes.

**Default Setting**

None

**Command Mode**

Privileged Exec  
User EXEC

**Display Message**

**Interface Mode** This field indicates whether DVMRP is enabled or disabled on the specified interface. This is a configured value.

**Interface Metric** This field indicates the metric of this interface. This is a configured value.

**Local Address** This is the IP Address of the interface.

*This Field is displayed only when DVMRP is operational on the interface.*

**Generation ID** This is the Generation ID value for the interface. This is used by the neighboring routers to detect that the DVMRP table should be resent.

**The following fields are displayed only if DVMRP is enabled on this interface.**

**Received Bad Packets** This is the number of invalid packets received.

**Received Bad Routes** This is the number of invalid routes received.

**Sent Routes** This is the number of routes that have been sent on this interface.

**8.1.1.3 show ip dvmrp neighbor**

This command displays the neighbor information for DVMRP.

**Syntax**

```
show ip dvmrp neighbor
```

**Default Setting**

None

**Command Mode**

Privileged Exec  
User EXEC

**Display Message**

**IfIndex** This field displays the value of the interface used to reach the neighbor.

**Nbr IP Addr** This field indicates the IP Address of the DVMRP neighbor for which this entry contains information.



**State** This field displays the state of the neighboring router. The possible value for this field are ACTIVE or DOWN.

**Up Time** This field indicates the time since this neighboring router was learned.

**Expiry Time** This field indicates the time remaining for the neighbor to age out. This field is not applicable if the State is DOWN.

**Generation ID** This is the Generation ID value for the neighbor.

**Major Version** This shows the major version of DVMRP protocol of neighbor.

**Minor Version** This shows the minor version of DVMRP protocol of neighbor.

**Capabilities** This shows the capabilities of neighbor.

**Received Routes** This shows the number of routes received from the neighbor.

**Rcvd Bad Pkts** This field displays the number of invalid packets received from this neighbor.

**Rcvd Bad Routes** This field displays the number of correct packets received with invalid routes.

#### 8.1.1.4 show ip dvmrp nexthop

This command displays the next hop information on outgoing interfaces for routing multicast datagrams.

<b>Syntax</b>
---------------

<code>show ip dvmrp nexthop</code>
------------------------------------

#### Default Setting

None

#### Command Mode

Privileged Exec  
User EXEC

#### Display Message

**Source IP** This field displays the sources for which this entry specifies a next hop on an outgoing interface.

**Source Mask** This field displays the IP Mask for the sources for which this entry specifies a next hop on an outgoing interface.

**Next Hop Interface** This field displays the interface in slot/port format for the outgoing interface for this next hop.

**Type** This field states whether the network is a LEAF or a BRANCH.

#### 8.1.1.5 show ip dvmrp prune

This command displays the table listing the router's upstream prune information.

<b>Syntax</b>
---------------

<code>show ip dvmrp prune</code>
----------------------------------

**Default Setting**

None

**Command Mode**Privileged Exec  
User EXEC**Display Message****Group IP** This field identifies the multicast Address that is pruned.**Source IP** This field displays the IP Address of the source that has pruned.**Source Mask** This field displays the network Mask for the prune source. It should be all 1s or both the prune source and prune mask must match.**Expiry Time (secs)** This field indicates the expiry time in seconds. This is the time remaining for this prune to age out.**8.1.1.6 show ip dvmrp route**

This command displays the multicast routing information for DVMRP.

**Syntax**

```
show ip dvmrp route
```

**Default Setting**

None

**Command Mode**Privileged Exec  
User EXEC**Display Message****Source Address** This field displays the multicast address of the source group.**Source Mask** This field displays the IP Mask for the source group.**Upstream Neighbor** This field indicates the IP Address of the neighbor which is the source for the packets for a specified multicast address.**Interface** This field displays the interface used to receive the packets sent by the sources.**Metric** This field displays the distance in hops to the source subnet. This field has a different meaning than the Interface Metric field.**Expiry Time(secs)** This field indicates the expiry time in seconds. This is the time remaining for this route to age out.**Up Time(secs)** This field indicates the time when a specified route was learnt, in seconds.**8.1.2 Configuration Commands****8.1.2.1 ip dvmrp**

This command sets administrative mode of DVMRP in the router to active. IGMP must be enabled before DVMRP can be enabled.

**Syntax**

```
ip dvmrp
no ip dvmrp
```

**no** - This command sets administrative mode of DVMRP in the router to inactive. IGMP must be enabled before DVMRP can be enabled.

**Default Setting**

Disabled

**Command Mode**

Global Config

This command sets the administrative mode of DVMRP on an interface to active.

**Syntax**

```
ip dvmrp
no ip dvmrp
```

**no** - This command sets administrative mode of DVMRP on an interface to inactive.

**Default Setting**

Disabled

**Command Mode**

Interface Config

**8.1.2.2 ip dvmrp metric**

This command configures the metric for an interface. This value is used in the DVMRP messages as the cost to reach this network.

**Syntax**

```
ip dvmrp metric <value>
no ip dvmrp metric <value>
```

**<value>** - This field has a range of 1 to 63.

**no** - This command resets the metric for an interface to the default value. This value is used in the DVMRP messages as the cost to reach this network.

**Default Setting**

1

**Command Mode**

Interface Config

## 8.2 Internet Group Management Protocol (IGMP) Commands

This section provides a detailed explanation of the IGMP commands. The commands are divided into the following different groups:

Show commands are used to display device settings, statistics and other information.

Configuration commands are used to configure features and options of the switch. For every configuration command there is a show command that will display the configuration setting.

### 8.2.1 Show Commands

#### 8.2.1.1 show ip igmp

This command displays the system-wide IGMP information.

**Syntax**

```
show ip igmp
```

**Default Setting**

None

**Command Mode**

Privileged Exec  
User EXEC

**Display Message**

**IGMP Admin Mode** This field displays the administrative status of IGMP. This is a configured value.

**Interface** Valid slot and port number separated by forward slashes.

**Interface Mode** This field indicates whether IGMP is enabled or disabled on the interface. This is a configured value.

**Protocol State** This field indicates the current state of IGMP on this interface. Possible values are Operational or Non-Operational.

### 8.2.1.2 show ip igmp groups

This command displays the registered multicast groups on the interface. If “detail” is specified this command displays the registered multicast groups on the interface in detail.

<b>Syntax</b>
---------------

<b>show ip igmp groups &lt;slot/port&gt; [detail]</b>
---

**<slot/port>** - Valid slot and port number separated by forward slashes.

**[detail]** - Display details of subscribed multicast groups.

#### Default Setting

None

#### Command Mode

Privileged Exec

#### Display Message

**IP Address** This displays the IP address of the interface participating in the multicast group.

**Subnet Mask** This displays the subnet mask of the interface participating in the multicast group.

**Interface Mode** This displays whether IGMP is enabled or disabled on this interface.

*The following fields are not displayed if the interface is not enabled:*

**Querier Status** This displays whether the interface has IGMP in Querier mode or Non-Querier mode.

**Groups** This displays the list of multicast groups that are registered on this interface.

#### If detail is specified, the following fields are displayed:

**Multicast IP Address** This displays the IP Address of the registered multicast group on this interface.

**Last Reporter** This displays the IP Address of the source of the last membership report received for the specified multicast group address on this interface.

**Up Time** This displays the time elapsed since the entry was created for the specified multicast group address on this interface.

**Expiry Time** This displays the amount of time remaining to remove this entry before it is aged out.

**Version1 Host Timer** This displays the time remaining until the local router will assume that there are no longer any IGMP version 1 multicast members on the IP subnet attached to this interface. This could be an integer value or “-----” if there is no Version 1 host present.

**Version2 Host Timer** This displays the time remaining until the local router will assume that there are no longer any IGMP version 2 multicast members on the IP subnet attached to this interface. This could be an integer value or “-----” if there is no Version 2 host present.

**Group Compatibility Mode** The group compatibility mode (v1, v2 or v3) for this group on the specified interface.

### 8.2.1.3 show ip igmp interface

This command displays the IGMP information for the interface.

#### Syntax

```
show ip igmp interface <slot/port>
```

<slot/port> - Valid slot and port number separated by forward slashes.

#### Default Setting

None

#### Command Mode

Privileged Exec  
User EXEC

#### Display Message

**Slot/Port** Valid slot and port number separated by forward slashes.

**IGMP Admin Mode** This field displays the administrative status of IGMP. This is a configured value.

**Interface Mode** This field indicates whether IGMP is enabled or disabled on the interface. This is a configured value.

**IGMP Version** This field indicates the version of IGMP running on the interface. This value can be configured to create a router capable of running either IGMP version 1 or 2.

**Query Interval (secs)** This field indicates the frequency at which IGMP Host-Query packets are transmitted on this interface. This is a configured value.

**Query Max Response Time (1/10 of a second)** This field indicates the maximum query response time advertised in IGMPv2 queries on this interface. This is a configured value.

**Robustness** This field displays the tuning for the expected packet loss on a subnet. If a subnet is expected to have a lot of loss, the Robustness variable may be increased for that interface. This is a configured value.

**Startup Query Interval (secs)** This value indicates the interval between General Queries sent by a Querier on startup. This is a configured value.

**Startup Query Count** This value is the number of Queries sent out on startup, separated by the Startup Query Interval. This is a configured value.

**Last Member Query Interval (1/10 of a second)** This value indicates the Maximum Response Time inserted into Group-Specific Queries sent in response to Leave Group messages. This is a configured

value.

**Last Member Query Count** This value is the number of Group-Specific Queries sent before the router assumes that there are no local members. This is a configured value.

#### 8.2.1.4 show ip igmp interface membership

This command displays the list of interfaces that have registered in the multicast group.

##### Syntax

```
show ip igmp interface membership <multiipaddr> [detail]
```

< multiipaddr > - A multicast IP address..

[detail] - Display details of subscribed multicast groups.

#### Default Setting

None

#### Command Mode

Privileged Exec  
User EXEC

#### Display Message

**Interface** Valid slot and port number separated by forward slashes.

**Interface IP** This displays the IP address of the interface participating in the multicast group.

**State** This displays whether the interface has IGMP in Querier mode or Non-Querier mode.

**Group Compatibility Mode** The group compatibility mode (v1, v2 or v3) for the specified group on this interface.

**Source Filter Mode** The source filter mode (Include/Exclude) for the specified group on this interface. This is "-----" for IGMPv1 and IGMPv2 Membership Reports.

#### *If detail is specified, the following fields are displayed:*

**Interface** Valid slot and port number separated by forward slashes.

**Group Compatibility Mode** The group compatibility mode (v1, v2 or v3) for the specified group on this interface.

**Source Filter Mode** The source filter mode (Include/Exclude) for the specified group on this interface. This is "-----" for IGMPv1 and IGMPv2 Membership Reports.

**Source Hosts** This displays the list of unicast source IP Addresses in the group record of the IGMPv3 Membership Report with the specified multicast group IP Address. This is "-----" for IGMPv1 and IGMPv2 Membership Reports.

**Expiry Time** This displays the amount of time remaining to remove this entry before it is aged out. This is "- ----" for IGMPv1 and IGMPv2 Membership Reports.

### 8.2.1.5 show ip igmp interface stats

This command displays the IGMP statistical information for the given interface. The statistics are only displayed when the interface is enabled for IGMP.

<b>Syntax</b>
---------------

<b>show ip igmp interface stats &lt;slot/port&gt;</b>
---

<slot/port> - Valid slot and port number separated by forward slashes.

#### Default Setting

None

#### Command Mode

Privileged Exec  
User EXEC

#### Display Message

**Querier Status** This field indicates the status of the IGMP router, whether it is running in Querier mode or Non-Querier mode.

**Querier IP Address** This field displays the IP Address of the IGMP Querier on the IP subnet to which this interface is attached.

**Querier Up Time** This field indicates the time since the interface Querier was last changed.

**Querier Expiry Time** This field displays the amount of time remaining before the Other Querier Present Timer expires. If the local system is the querier, the value of this object is zero.

**Wrong Version Queries** This field indicates the number of queries received whose IGMP version does not match the IGMP version of the interface.

**Number of Joins** This field displays the number of times a group membership has been added on this interface.

**Number of Groups** This field indicates the current number of membership entries for this interface.

## 8.2.2 Configuration Commands

### 8.2.2.1 ip igmp

This command sets the administrative mode of IGMP in the router to active.



**Syntax**

```
ip igmp
no ip igmp
```

**no** - This command sets the administrative mode of IGMP in the router to inactive.

**Default Setting**

Disabled

**Command Mode**

Global Config

This command sets the administrative mode of IGMP on an interface to active.

**Syntax**

```
ip igmp
no ip igmp
```

**no** - This command sets the administrative mode of IGMP on an interface to inactive.

**Default Setting**

Disabled

**Command Mode**

Interface Config

**8.2.2.2 ip igmp version**

This command configures the version of IGMP for an interface.

**Syntax**

```
ip igmp version {1 | 2 | 3}
no ip igmp version
```

<1- 3> - The igmp version number.

**no** - This command resets the version of IGMP for this interface. The version is reset to the default value.

### Default Setting

3

### Command Mode

Interface Config

#### 8.2.2.3 ip igmp last-member-query-count

This command sets the number of Group-Specific Queries sent before the router assumes that there are no local members on the interface.

<b>Syntax</b>
---------------

<pre>ip igmp last-member-query-count &lt;1-20&gt; no ip igmp last-member-query-count</pre>
--

**<1-20>** - The range for <1-20> is 1 to 20.

**no** - This command resets the number of Group-Specific Queries to the default value.

### Default Setting

Disabled

### Command Mode

Interface Config

#### 8.2.2.4 ip igmp last-member-query-interval

This command configures the Maximum Response Time being inserted into Group-Specific Queries sent in response to Leave Group messages on the interface.

<b>Syntax</b>
---------------

<pre>ip igmp last-member-query-interval &lt;0-255&gt; no ip igmp last-member-query-interval</pre>
---

**<0-255>** - The range for <0-255> is 0 to 255 tenths of a second.

**no** - This command resets the Maximum Response Time being inserted into

Group-Specific Queries sent in response to Leave Group messages on the interface to the default value.

**Default Setting**

1 second

**Command Mode**

Interface Config

**8.2.2.5 ip igmp query-interval**

This command configures the query interval for the specified interface. This is the frequency at which IGMP Host-Query packets are transmitted on this interface.

**Syntax**

```
ip igmp query-interval <1-3600>  
no ip igmp query-interval
```

**<1-3600>** - The range for <1-3600> is 1 to 3600 seconds.

**no** - This command resets the query interval for the specified interface to the default value. This is the frequency at which IGMP Host-Query packets are transmitted on this interface.

**Default Setting**

125 seconds

**Command Mode**

Interface Config

**8.2.2.6 ip igmp query-max-response-time**

This command configures the maximum response time interval for the specified interface, which is the maximum query response time advertised in IGMPv2 queries on this interface. The time interval is specified in tenths of a second.

**Syntax**

```
ip igmp query-max-response-time <0-255>  
no ip igmp query-max-response-time
```

**<0-255>** - The range for <0-255> is 0 to 255 tenths of a second.

**no** - This command resets the maximum response time interval for the specified interface, which is the maximum query response time advertised in IGMPv2 queries on this interface to the default value. The maximum response time interval is reset to the default time.

**Default Setting**

100

**Command Mode**

Interface Config

**8.2.2.7 ip igmp robustness**

This command configures the robustness that allows tuning of the interface. The robustness is the tuning for the expected packet loss on a subnet. If a subnet is expected to have a lot of loss, the Robustness variable may be increased for the interface.

**Syntax**

```
ip igmp robustness <1-255>  
no ip igmp robustness
```

**<1-255>** - The range for <1-255> is 1 to 255.

**no** - This command sets the robustness value to default.

**Default Setting**

2

**Command Mode**

Interface Config

**8.2.2.8 ip igmp startup-query-count**

This command sets the number of Queries sent out on startup, separated by the Startup Query Interval on the interface.

**Syntax**

```
ip igmp startup-query-count <1-20>  
no ip igmp startup-query-count
```

**<1-20>** - The range for <1-20> is 1 to 20.

**no** - This command resets the number of Queries sent out on startup, separated by the Startup Query Interval on the interface to the default value.

#### Default Setting

2

#### Command Mode

Interface Config

#### 8.2.2.9 ip igmp startup-query-interval

This command sets the interval between General Queries sent by a Querier on startup on the interface. The time interval value is in seconds.

<b>Syntax</b>
---------------

<pre>ip igmp startup-query-interval &lt;1-300&gt; no ip igmp startup-query-interval</pre>
---

**<1-300>** - The range for <1-300> is 1 to 300 seconds.

**no** - This command resets the interval between General Queries sent by a Querier on startup on the interface to the default value.

#### Default Setting

31

#### Command Mode

Interface Config

### 8.3 Multicast Commands

#### 8.3.1 Show Commands

##### 8.3.1.1 show ip mcast

This command displays the system-wide multicast information

**Syntax**

```
show ip mcast
```

**Default Setting**

None

**Command Mode**

Privileged Exec

**Display Message**

**Admin Mode:** This field displays the administrative status of multicast. This is a configured value.

**Protocol State:** This field indicates the current state of the multicast protocol. Possible values are Operational or Non-Operational.

**Table Max Size:** This field displays the maximum number of entries allowed in the multicast table.

**Number Of Packets For Which Source Not Found:** This displays the number of packets for which the source is not found.

**Number Of Packets For Which Group Not Found:** This displays the number of packets for which the group is not found.

**Protocol:** This field displays the multicast protocol running on the router. Possible values are PIMDM, PIMSM, or DVMRP.

**Forwarding Multicast Stream Entry Count:** This field displays the number of entries in the multicast table.

**Highest Entry Count:** This field displays the highest entry count in the multicast table.

**8.3.1.2 show ip mcast boundary**

This command displays all the configured administrative scoped multicast boundaries.

**Syntax**

```
show ip mcast boundary {<slot/port> | all}
```

**<slot/port >** - Interface number.

**all** - This command represents all interfaces.

**Default Setting**

None

**Command Mode**

Privileged Exec

### Display Message

**Interface:** Valid slot and port number separated by forward slashes.

**Group IP:** The group IP address.

**Mask:** The group IP mask.

#### 8.3.1.3 show ip mcast interface

This command displays the multicast information for the specified interface.

<b>Syntax</b>
---------------

<b>show ip mcast interface &lt;slot/port&gt;</b>
--

**<slot/port >** - Interface number.

### Default Setting

None

### Command Mode

Privileged Exec

### Display Message

**Interface:** Valid slot and port number separated by forward slashes.

**TTL:** This field displays the time-to-live value for this interface.

#### 8.3.1.4 show ip mcast mroute

This command displays a summary or all the details of the multicast table.

<b>Syntax</b>
---------------

<b>show ip mcast mroute {detail   summary}</b>
--

**detail** - displays the multicast routing table details.

**summary** - displays the multicast routing table summary.

**Default Setting**

None

**Command Mode**

Privileged Exec

**Display Message**

If the “**detail**” parameter is specified, the following fields are displayed:

**Source IP:** This field displays the IP address of the multicast data source.

**Group IP:** This field displays the IP address of the destination of the multicast packet.

**Expiry Time (secs):** This field displays the time of expiry of this entry in seconds.

**Up Time (secs):** This field displays the time elapsed since the entry was created in seconds.

**RPF Neighbor:** This field displays the IP address of the RPF neighbor.

**Flags:** This field displays the flags associated with this entry.

If the “**summary**” parameter is specified, the following fields are displayed:

**Source IP:** This field displays the IP address of the multicast data source.

**Group IP:** This field displays the IP address of the destination of the multicast packet.

**Protocol:** This field displays the multicast routing protocol by which this entry was created.

**Incoming Interface:** This field displays the interface on which the packet for this source/group arrives.

**Outgoing Interface List:** This field displays the list of outgoing interfaces on which this packet is forwarded.

This command displays the multicast configuration settings such as flags, timer settings, incoming and outgoing interfaces, RPF neighboring routers, and expiration times of all the entries in the multicast mroute table containing the given <groupipaddr>.

**Syntax**

```
show ip mcast mroute group <groupipaddr> {detail |summary}
```

**< groupipaddr >** - the IP Address of the destination of the multicast packet.

**detail** - Display the multicast routing table details.

**summary** - Display the multicast routing table summary.

**Default Setting**

None

**Command Mode**

Privileged Exec



## Display Message

If the **detail** parameter is specified the follow fields are displayed:

**Source IP:** This field displays the IP address of the multicast data source.

**Group IP:** This field displays the IP address of the destination of the multicast packet.

**Expiry Time (secs):** This field displays the time of expiry of this entry in seconds.

**Up Time (secs):** This field displays the time elapsed since the entry was created in seconds.

**RPF Neighbor:** This field displays the IP address of the RPF neighbor.

**Flags:** This field displays the flags associated with this entry.

If the **summary** parameter is specified the follow fields are displayed:

**Source IP:** This field displays the IP address of the multicast data source.

**Group IP:** This field displays the IP address of the destination of the multicast packet.

**Protocol** This field displays the multicast routing protocol by which this entry was created.

**Incoming Interface:** This field displays the interface on which the packet for this group arrives.

**Outgoing Interface List:** This field displays the list of outgoing interfaces on which this packet is forwarded.

This command displays the multicast configuration settings such as flags, timer settings, incoming and outgoing interfaces, RPF neighboring routers, and expiration times of all the entries in the multicast mroute table containing the given <sourceipaddr> or <sourceipaddr> [<groupipaddr>] pair.

### Syntax

```
show ip mcast mroute source <sourceipaddr> {summary | <groupipaddr>}
```

< sourceipaddr > - the IP Address of the multicast data source.

**summary** - display the multicast routing table summary

< groupipaddr > - the IP Address of the destination of the multicast packet.

## Default Setting

None

## Command Mode

Privileged Exec

## Display Message

If the < **groupipaddr** > parameter is specified the follow fields are displayed:

**Source IP:** This field displays the IP address of the multicast data source.

**Group IP:** This field displays the IP address of the destination of the multicast packet.

**Expiry Time (secs):** This field displays the time of expiry of this entry in seconds.

**Up Time (secs):** This field displays the time elapsed since the entry was created in seconds.

**RPF Neighbor:** This field displays the IP address of the RPF neighbor.

**Flags:** This field displays the flags associated with this entry.

If the **summary** parameter is specified the follow fields are displayed:

**Source IP:** This field displays the IP address of the multicast data source.

**Group IP:** This field displays the IP address of the destination of the multicast packet.

**Protocol:** This field displays the multicast routing protocol by which this entry was created.

**Incoming Interface:** This field displays the interface on which the packet for this source arrives.

**Outgoing Interface List:** This field displays the list of outgoing interfaces on which this packet is forwarded.

This command displays all the static routes configured in the static mcast table if is specified or displays the static route associated with the particular <sourceipaddr>.

#### Syntax

```
show ip mcast mroute static [<sourceipaddr>]
```

< sourceipaddr > - the IP Address of the multicast data source.

#### Default Setting

None

#### Command Mode

Privileged Exec

#### Display Message

**Source IP:** This field displays the IP address of the multicast packet source.

**Source Mask:** This field displays the mask applied to the IP address of the multicast packet source.

**RPF Address:** This field displays the IP address to be used as RPF for the given source and mask.

**Metric:** This field displays the metric value corresponding to the source address.

**Interface:** Valid slot and port number separated by forward slashes.

#### 8.3.1.5 show mrinfo

This command is used to display the neighbor information of a multicast-capable router from the results buffer pool of the router subsequent to the execution/completion of a "mrinfo

[ipaddr]" command. The results subsequent to the completion of the latest "mrinfo" will be available in the buffer pool after a maximum duration of two minutes after the completion of the 'show mrinfo' command. A subsequent issue 'mrinfo' will overwrite the contents of the buffer pool with fresh results.

**Syntax**

```
show mrinfo
```

**Default Setting**

None

**Command Mode**

Privileged Exec

**Display Message**

**Router Interface:** The IP address of this neighbor.

**Neighbor:** The neighbor associated with the router interface.

**Metric:** The metric value associated with this neighbor.

**TTL:** The TTL threshold associated with this neighbor.

**Flags:** Status of the neighbor.

**8.3.1.6 show mstat**

This command is used to display the results of packet rate and loss information from the results buffer pool of the router, subsequent to the execution/completion of a 'mstat <source> [group] [receiver]' command. Within two minutes of the completion of the 'mstat' command, the results will be available in the buffer pool. The next issuing of "mstat" would overwrite the buffer pool with fresh results.

**Syntax**

```
show mstat
```

**Default Setting**

None

**Command Mode**

Privileged Exec

**Display Message**

### 8.3.1.7 show mtrace

This command is used to display results of multicast trace path from the results buffer pool of the router, subsequent to the execution/completion of a "mtrace <source> [group] [receiver]" command. The results subsequent to the completion of the "mtrace" will be available in the buffer pool within 2 minutes and thereafter. A subsequent "mtrace" command would overwrite the results in the buffer pool.

<b>Syntax</b>
---------------

<code>show mtrace</code>
--------------------------

#### Default Setting

None

#### Command Mode

Privileged Exec

#### Display Message

**Hops Away From Destination:** The ordering of intermediate routers between the source and the destination.

**Intermediate Router Address:** The address of the intermediate router at the specified hop distance.

**Mcast Protocol In Use:** The multicast routing protocol used for the out interface of the specified intermediate router.

**TTL Threshold:** The Time-To-Live threshold of the out interface on the specified intermediate router.

**Time Elapsed Between Hops (msecs):** The time between arrival at one intermediate router to the arrival at the next.

## 8.3.2 Configuration Commands

### 8.3.2.1 ip multicast

This command sets the administrative mode of the IP multicast forwarder in the router to active. For multicast routing to become operational, IGMP must be currently enabled. An error message will be displayed on the CLI if multicast routing is enabled while IGMP is disabled. However, the IP multicast mode configuration is stored in the multicast configuration file and is automatically enabled once IGMP is enabled.

**Syntax**

```
ip multicast
no ip multicast
```

**no** - This command sets the administrative mode of the IP multicast forwarder in the router to inactive. For multicast routing to become operational, IGMP must be currently enabled. An error message will be displayed on the CLI if multicast routing is enabled while IGMP is disabled. However, the IP multicast mode configuration is stored in the multicast configuration file and is automatically enabled once IGMP is enabled.

**Default Setting**

Disable

**Command Mode**

Global Config

**8.3.2.2 ip multicast staticroute**

This command creates a static route which is used to perform RPF checking in multicast packet forwarding. The combination of the <sourceipaddr> and the <mask> fields specify the network IP address of the multicast packet source. The <groupipaddr> is the IP address of the next hop toward the source. The <metric> is the cost of the route entry for comparison with other routes to the source network and is a value in the range of 0 and 255. The *current* incoming interface is used for RPF checking for multicast packets matching this multicast static route entry.

**Syntax**

```
ip multicast staticroute <sourceipaddr> <mask> <rpfipaddr> <0-255> <slot/port>
no ip multicast staticroute <sourceipaddr>
```

**<sourceipaddr>** - the IP Address that identifies the multicast packet source for the entry you are creating.

**<mask>** - the subnet mask to be applied to the Source IP address.

**<rpfipaddr>** - the IP address of the neighbor router on the path to the source.

**<0-255 >** - the link state cost of the path to the multicast source. The range is 0 – 255.

**<slot/port>** - the interface number.

**no** - This command deletes a static route in the static mcast table. The <sourceipaddr> is the IP address of the multicast packet source.

**Default Setting**

None

**Command Mode**

Global Config

**8.3.2.3 no ip mcast mroute**

This command is used to clear entries in the mroute table. The all parameters is used to clear all entries.

The source parameter is used to clear the routes in the mroute table entries containing the specified <sourceipaddr> or <sourceipaddr> [groupipaddr] pair. The source address is the source IP address of the multicast packet. The group address is the Group Destination IP address of the multicast packet.

The group parameter is used to clear the routes in the mroute table entries containing the specified <groupipaddr>. The group address is the Group Destination IP address of the multicast packet.

**Syntax**

```
no ip mcast mroute {group <groupipaddr> | source <sourceipaddr> [<groupipaddr>] | all}
```

< **groupipaddr** > - the IP address of the destination of the multicast packet.

< **sourceipaddr** > - the IP address of the multicast packet source.

**all** - This command is used to clear all entries.

**Default Setting**

None

**Command Mode**

Global Config

### 8.3.2.4 ip mcast boundary

This command adds an administrative scope multicast boundary specified by <groupipaddr> and <mask> for which this multicast administrative boundary is applicable. <groupipaddr> is a group IP address and <mask> is a group IP mask.

**Syntax**

```
ip mcast boundary <groupipaddr> <mask>  
no ip mcast boundary <groupipaddr> <mask>
```

**< groupipaddr >** - the multicast group address for the start of the range of addresses to be excluded. The address must be in the range of 239.0.0.0 through 239.255.255.255.

**< mask >** - mask to be applied to the multicast group address.

**no** - This command deletes an administrative scope multicast boundary specified by <groupipaddr> and <mask> for which this multicast administrative boundary is applicable. <groupipaddr> is a group IP address and <mask> is a group IP mask.

**Default Setting**

None

**Command Mode**

Interface Config

### 8.3.2.5 ip multicast ttl-threshold

This command applies the given <ttlthreshold> to a routing interface. The <ttlthreshold> is the TTL threshold which is to be applied to the multicast Data packets which are to be forwarded from the interface. The value for <ttlthreshold> has range from 0 to 255.

**Syntax**

```
ip multicast ttl-threshold <0 - 255>  
no ip multicast ttl-threshold
```

**< 0 - 255 >** - the TTL threshold.

**no** - This command applies the default <ttlthreshold> to a routing interface. The <ttlthreshold> is the TTL threshold which is to be applied to the multicast Data packets which are to be forwarded from the interface.

**Default Setting**

1

**Command Mode**

Interface Config

**8.3.2.6 mrinfo**

This command is used to query the neighbor information of a multicast-capable router specified by [<ipaddr>]. The default value is the IP address of the system at which the command is issued. The mrinfo command can take up to 2 minutes to complete. Only one mrinfo command may be in process at a time. The results of this command will be available in the results bufferpool which can be displayed by using "show mrinfo".

**Syntax**

```
mrinfo [<ipaddr>]
```

<ipaddr> - the IP address of the multicast capable router.

**Default Setting**

None

**Command Mode**

Privileged Exec

**8.3.2.7 mstat**

This command is used to find the packet rate and loss information path from a source to a receiver (unicast router id of the host running mstat). The results of this command will be available in the results bufferpool which can be displayed by using "show mstat". If a debug command is already in progress, a message is displayed and the new request fails.

The <source> is the IP Address of the remote multicast-capable source. The [<receiver>] is the IP address of the receiver. The default value is the IP address of system at which the command is issued. The [<group>] is a multicast address of the group to be displayed. Default value is 224.2.0.1



**Syntax**

```
mstat <source> [<group>] [<receiver>]
```

**< source >** - the IP address of the multicast data source.

**<group>** - the multicast address of the group to be traced. If you leave this field blank, the multicast address 224.2.0.1 will be used. Valid addresses are 224.0.0.0 through 239.255.255.255.

**< receiver >** - the IP address of the host to which the *mstat* response will be sent by the last hop router.

**Default Setting**

None

**Command Mode**

Privileged Exec

**8.3.2.8 mtrace**

This command is used to find the multicast path from a source to a receiver (unicast router ID of the host running mtrace). A trace query is passed hop-by-hop along the reverse path from the receiver to the source, collecting hop addresses, packet counts, and routing error conditions along the path, and then the response is returned to the requestor. The results of this command will be available in the results buffer pool which can be displayed by using "show mtrace".

The <source> is the IP Address of the remote multicast-capable source. The [<destination>] is the IP address of the receiver. The default value is the IP address of system at which the command is issued. The [<group>] is the multicast address of the group to be displayed. The default value is 224.2.0.1

If a debug command is already in execution, a message is displayed and the new request fails.

**Syntax**

```
mtrace <source> [<group>] [<destination>]
```

**< source >** - the IP address of the multicast data source.

**< group >** - the Multicast address of the group to be traced. If you do not enter a valid address, multicast address 224.2.0.1 will be used. Valid addresses are 224.0.0.0 through 239.255.255.255.

**< destination >** - the IP address of the host to which the *mtrace* response will be sent by

the last hop router.

**Default Setting**

None

**Command Mode**

Privileged Exec

**8.3.2.9 disable ip multicast mdebug mtrace**

This command is used to disable the processing capability of mtrace query on this router. If the mode is enabled, the mtrace queries received by the router are processed and forwarded appropriately by the router. If the mode is disabled, this router does not respond to the mtrace queries it receives from other router devices.

**Syntax**

```
disable ip multicast mdebug mtrace  
no disable ip multicast mdebug mtrace
```

**no** - This command is used to enable the processing capability of mtrace query on this router. If the mode is enabled, the mtrace queries received by the router are processed and forwarded appropriately by the router. If the mode is disabled, this router does not respond to the mtrace queries it receives from other router devices.

**Default Setting**

None

**Command Mode**

Global Config

**8.4 Protocol Independent Multicast – Dense Mode (PIM-DM) Commands****8.4.1 Show Commands****8.4.1.1 show ip pimdm**

This command displays the system-wide information for PIM-DM.

**Syntax**

```
show ip pimdm
```

**Default Setting**

None

**Command Mode**

Privileged Exec

**Display Message**

**Admin Mode:** This field indicates whether PIM-DM is enabled or disabled. This is a configured value.

**Interface:** Valid slot and port number separated by forward slashes.

**Interface Mode:** This field indicates whether PIM-DM is enabled or disabled on this interface. This is a configured value.

**Protocol State:** This field indicates the current state of PIM-DM on this interface. Possible values are Operational or Non-Operational.

#### 8.4.1.2 show ip pimdm interface

This command displays the interface information for PIM-DM on the specified interface.

**Syntax**

```
show ip pimdm interface <slot/port>
```

<slot/port > - Interface number.

**Default Setting**

None

**Command Mode**

Privileged Exec

**Display Message**

**Interface Mode:** This field indicates whether PIM-DM is enabled or disabled on the specified interface. This is a configured value.

**Hello Interval (secs):** This field indicates the frequency at which PIM hello messages are

transmitted on this interface. By default, the value is 30 seconds.

#### 8.4.1.3 show ip pimdm interface stats

This command displays the statistical information for PIM-DM on the specified interface.

##### Syntax

```
show ip pimdm interface stats {<slot/port> | all}
```

**<slot/port>** - Interface number.

**all** - this command represents all interfaces.

##### Default Setting

None

##### Command Mode

Privileged Exec

##### Display Message

**Interface:** Valid slot and port number separated by forward slashes.

**IP Address:** This field indicates the IP Address that represents the PIM-DM interface.

**Nbr Count:** This field displays the neighbor count for the PIM-DM interface.

**Hello Interval:** This field indicates the time interval between two hello messages sent from the router on the given interface.

**Designated Router:** This indicates the IP Address of the Designated Router for this interface.

#### 8.4.1.4 show ip pimdm neighbor

This command displays the neighbor information for PIM-DM on the specified interface.

##### Syntax

```
show ip pimdm neighbor [<slot/port> | all]
```

**<slot/port>** - Interface number.

**all** - this command represents all interfaces.

**Default Setting**

None

**Command Mode**

Privileged Exec

**Display Message**

**Neighbor Addr:** This field displays the IP Address of the neighbor on an interface.

**Interface:** Valid slot and port number separated by forward slashes.

**Up Time:** This field indicates the time since this neighbor has become active on this interface.

**Expiry Time:** This field indicates the expiry time of the neighbor on this interface.

## 8.4.2 Configuration Commands

### 8.4.2.1 ip pimdm

This command enables the administrative mode of PIM-DM in the router.

<b>Syntax</b>
<b>ip pimdm</b> <b>no ip pimdm</b>

**no** - This command disables the administrative mode of PIM-DM in the router. IGMP must be enabled before PIM-DM can be enabled.

**Default Setting**

Disabled

**Command Mode**

Global Config

### 8.4.2.2 ip pimdm mode

This command sets administrative mode of PIM-DM on an interface to enabled.

**Syntax**

```
ip pimdm mode
no ip pimdm mode
```

**no** - This command sets administrative mode of PIM-DM on an interface to disabled.

**Default Setting**

Disabled

**Command Mode**

Interface Config

**8.4.2.3 ip pimdm query-interval**

This command configures the transmission frequency of hello messages between PIM enabled neighbors. This field has a range of 10 to 3600 seconds.

**Syntax**

```
ip pimdm query-interval <10 - 3600>
no ip pimdm query-interval
```

**<10 - 3600>** - This is time interval in seconds.

**no** - This command resets the transmission frequency of hello messages between PIM enabled neighbors to the default value.

**Default Setting**

30

**Command Mode**

Interface Config

**8.5 Protocol Independent Multicast – Sparse Mode (PIM-SM) Commands**

## 8.5.1 Show Commands

### 8.5.1.1 show ip pimsm

This command displays the system-wide information for PIM-SM.

<b>Syntax</b>
---------------

<b>show ip pimsm</b>
----------------------

#### Default Setting

None

#### Command Mode

Privileged Exec

#### Display Message

**Admin Mode:** This field indicates whether PIM-SM is enabled or disabled. This is a configured value.

**Join/Prune Interval (secs):** This field shows the interval at which periodic PIM-SM Join/Prune messages are to be sent. This is a configured value.

**Data Threshold Rate (Kbps):** This field shows the data threshold rate for the PIM-SM router. This is a configured value.

**Register Threshold Rate (Kbps):** This field indicates the threshold rate for the RP router to switch to the shortest path. This is a configured value.

**Interface:** Valid slot and port number separated by forward slashes.

**Interface Mode:** This field indicates whether PIM-SM is enabled or disabled on the interface. This is a configured value.

**Protocol State:** This field indicates the current state of the PIM-SM protocol on the interface. Possible values are Operational or Non-Operational.

### 8.5.1.2 show ip pimsm componenttable

This command displays the table containing objects specific to a PIM domain. One row exists for each domain to which the router is connected.

<b>Syntax</b>
---------------

<b>show ip pimsm componenttable</b>
-------------------------------------

#### Default Setting

None

**Command Mode**

Privileged Exec

**Display Message**

**Component Index:** This field displays a number which uniquely identifies the component.

**Component BSR Address:** This field displays the IP address of the bootstrap router (BSR) for the local PIM region.

**Component BSR Expiry Time:** This field displays the minimum time remaining before the BSR in the local domain will be declared down.

**Component CRP Hold Time:** This field displays the hold time of the component when it is a candidate.

### 8.5.1.3 show ip pimsm interface

This command displays the interface information for PIM-SM on the specified interface.

<b>Syntax</b>
---------------

<pre>show ip pimsm interface &lt;slot/port&gt;</pre>
--

<slot/port> - Interface number.

**Default Setting**

None

**Command Mode**

Privileged Exec

**Display Message**

**Slot/Port:** Valid slot and port number separated by forward slashes.

**IP Address:** This field indicates the IP address of the specified interface.

**Subnet Mask:** This field indicates the Subnet Mask for the IP address of the PIM interface.

**Mode:** This field indicates whether PIM-SM is enabled or disabled on the specified interface. This is a configured value. By default it is disabled.

**Hello Interval:** This field indicates the frequency at which PIM hello messages are transmitted on this interface. This is a configured value. By default, the value is 30 seconds.

**CBSR Preference:** This field shows the preference value for the local interface as a candidate bootstrap router. This is a configured value.

**CRP Preference:** This field shows the preference value as a candidate rendezvous point on this interface.

**CBSR Hash Mask Length:** This field shows the hash mask length to be advertised in bootstrap messages if this interface is elected as the bootstrap router. The value is used in



the hash algorithm for selecting the RP for a particular group.

#### 8.5.1.4 show ip pimsm interface stats

This command displays the statistical information for PIM-SM on the specified interface.

##### Syntax

```
show ip pimsm interface stats {<slot/port> | all}
```

**<slot/port>** - Interface number.

**all** - this command represents all interfaces.

##### Default Setting

None

##### Command Mode

Privileged Exec

##### Display Message

**Interface:** Valid slot and port number separated by forward slashes.

**IP Address:** This field indicates the IP Address that represents the PIM-SM interface.

**Subnet Mask:** This field indicates the Subnet Mask of this PIM-SM interface.

**Designated Router:** This indicates the IP Address of the Designated Router for this interface.

**Neighbor Count:** This field displays the number of neighbors on the PIM-SM interface.

#### 8.5.1.5 show ip pimsm neighbor

This command displays the neighbor information for PIM-SM on the specified interface.

##### Syntax

```
show ip pimsm neighbor [<slot/port> | all]
```

**<slot/port>** - Interface number.

**all** - this command represents all interfaces.

**Default Setting**

None

**Command Mode**

Privileged Exec

**Display Message**

**Interface:** Valid slot and port number separated by forward slashes.

**IP Address:** This field displays the IP Address of the neighbor on an interface.

**Up Time:** This field indicates the time since this neighbor has become active on this interface.

**Expiry Time:** This field indicates the expiry time of the neighbor on this interface.

**8.5.1.6 show ip pimsm rp**

This command displays the PIM information for candidate Rendezvous Points (RPs) for all IP multicast groups or for the specific <group-address> <group-mask> provided in the command. The information in the table is displayed for each IP multicast group.

**Syntax**

```
show ip pimsm rp {<group-address> <group-mask> | candidate | all}
```

**< group-address >** - the IP multicast group address.

**< group-mask >** - the multicast group address mask.

**candidate** - this command display PIM-SM candidate-RP table information.

**all** - this command display all group addresses.

**Default Setting**

None

**Command Mode**

Privileged Exec

**Display Message**

**Group Address:** This field specifies the IP multicast group address.

**Group Mask:** This field specifies the multicast group address subnet mask.

**Address:** This field displays the IP address of the Candidate-RP.

**Hold Time:** This field displays the hold time of a Candidate-RP.

**Expiry Time:** This field displays the minimum time remaining before the Candidate-RP will be declared down.

**Component:** This field displays a number which uniquely identifies the component. Each protocol instance connected to a separate domain should have a different index value.

If the “**candidate**” parameter is specified the follow fields are displayed:

**Group Address:** This field specifies the IP multicast group address.

**Group Mask:** This field specifies the multicast group address subnet mask.

**Address:** This field displays the IP address of the Candidate-RP.

### 8.5.1.7 show ip pimsm rphash

This command displays the RP router that will be selected from the set of active RP routers. The RP router, for the group, is selected by using the hash algorithm defined in RFC 2362.

<b>Syntax</b>
---------------

<b>show ip pimsm rphash &lt;group-address&gt;</b>
---

< **group-address** > - the IP multicast group address.

#### Default Setting

None

#### Command Mode

Privileged Exec

#### Display Message

**IP Address:** This field displays the IP address of the RP.

**Group Mask:** This field displays the group mask for the group address.

### 8.5.1.8 show ip pimsm staticrp

This command displays the static RP information for the PIM-SM router.

<b>Syntax</b>
---------------

<b>show ip pimsm staticrp</b>
-------------------------------

**Default Setting**

None

**Command Mode**

Privileged Exec

**Display Message****Address:** This field displays the IP address of the RP.**Group Address:** This field displays the group address supported by the RP.**Group Mask:** This field displays the group mask for the group address.

## 8.5.2 Configuration Commands

### 8.5.2.1 ip pimsm

This command sets administrative mode of PIM-SM multicast routing across the router to enabled. IGMP must be enabled before PIM-SM can be enabled.

**Syntax**

```
ip pimsm
no ip pimsm
```

**no** - This command sets administrative mode of PIM-SM multicast routing across the router to disabled. IGMP must be enabled before PIM-SM can be enabled.

**Default Setting**

Disbaled

**Command Mode**

Global Config

### 8.5.2.2 ip pimsm message-interval

This command is used to configure the global join/prune interval for PIM-SM router. The join/prune interval is specified in seconds. This parameter can be configured to a value from 10 to 3600.

**Syntax**

```
ip pimsm message-interval <10 - 3600>  
no ip pimsm message-interval
```

**<10 - 3600>** - This is time interval in seconds.

**no** - This command is used to reset the global join/prune interval for PIM-SM router to the default value.

**Default Setting**

60

**Command Mode**

Global Config

**8.5.2.3 ip pimsm register-rate-limit**

This command is used to configure the Threshold rate for the RP router to switch to the shortest path. The rate is specified in Kilobytes per second. The possible values are 0 to 2000.

**Syntax**

```
ip pimsm register-rate-limit <0 - 2000>  
no ip pimsm register-rate-limit
```

**<0 - 2000>** - This is time interval in seconds.

**no** - This command is used to reset the Threshold rate for the RP router to switch to the shortest path to the default value.

**Default Setting**

50

**Command Mode**

Global Config

#### 8.5.2.4 ip pimsm spt-threshold

This command is used to configure the Threshold rate for the last-hop router to switch to the shortest path. The rate is specified in Kilobytes per second. The possible values are 0 to 2000.

##### Syntax

```
ip pimsm spt-threshold <0 - 2000>
no ip pimsm spt-threshold
```

**<0 - 2000>** - This is time interval in seconds.

**no** - This command is used to reset the Threshold rate for the last-hop router to switch to the shortest path to the default value.

##### Default Setting

50

##### Command Mode

Global Config

#### 8.5.2.5 ip pimsm staticrp

This command is used to create RP IP address for the PIM-SM router. The parameter <rp-address> is the IP address of the RP. The parameter <group-address> is the group address supported by the RP. The parameter <group-mask> is the group mask for the group address.

##### Syntax

```
ip pimsm staticrp <rp-address> <group-address> <group-mask>
no ip pimsm staticrp <rp-address> <group-address> <group-mask>
```

**< rp-address >** - the IP Address of the RP.

**< group-address >** - the group address supported by the RP.

**< group-mask >** - the group mask for the group address.

**no** - This command is used to delete RP IP address for the PIM-SM router. The parameter <rp-address> is the IP address of the RP. The parameter <group-address> is the group address supported by the RP. The parameter <group-mask> is the group mask for the group address.

**Default Setting**

Disabled

**Command Mode**

Global Config

**8.5.2.6 ip pimsm mode**

This command sets administrative mode of PIM-SM multicast routing on a routing interface to enable.

**Syntax**

```
ip pimsm mode
no ip pimsm mode
```

**no** - This command sets administrative mode of PIM-SM multicast routing on a routing interface to disabled.

**Default Setting**

Disbaled

**Command Mode**

Interface Config

**8.5.2.7 ip pimsm query-interval**

This command configures the transmission frequency of hello messages in seconds between PIM enabled neighbors. This field has a range of 10 to 3600 seconds.

**Syntax**

```
ip pimsm query-interval <10 - 3600>
no ip pimsm query-interval
```

**<10 - 3600>** - This is time interval in seconds.

**no** - This command resets the transmission frequency of hello messages between PIM enabled neighbors to the default value.

**Default Setting**

30

**Command Mode**

Interface Config

**8.5.2.8 ip pimsm cbsrpreference**

This command is used to configure the CBSR preference for a particular PIM-SM interface. The range of CBSR preference is -1 to 255.

**Syntax**

```
ip pimsm cbsrpreference <-1 - 255>  
no ip pimsm cbsrpreference
```

**<-1 - 255>** - The preference value for the local interface.

**no** - This command is used to reset the CBSR preference for a particular PIM-SM interface to the default value.

**Default Setting**

0

**Command Mode**

Interface Config

**8.5.2.9 ip pimsm cbsrhashmasklength**

This command is used to configure the CBSR hash mask length to be advertised in bootstrap messages for a particular PIM-SM interface. This hash mask length will be used in the hash algorithm for selecting the RP for a particular group. The valid range is 0 - 32. The default value is 30.

**Syntax**



```
ip pimsm cbsrhashmasklength <0 - 32>
no ip pimsm cbsrhashmasklength
```

**<0 - 32>** - The CBSR hash mask length.

**no** - This command is used to reset the CBSR hash mask length for a particular PIM-SM interface to the default value.

### Default Setting

30

### Command Mode

Interface Config

#### 8.5.2.10 ip pimsm crppreference

This command is used to configure the Candidate Rendezvous Point (CRP) for a particular PIM-SM interface. The valid values are from (-1 to 255), and the value of -1 is used to indicate that the local interface is not a Candidate RP interface.

The active router interface, with the highest IP Address and crppreference greater than -1, is chosen as the CRP for the router. The default value is 0.

In the CRP advertisements sent to the bootstrap router (BSR), the router interface advertises itself as the CRP for the group range 224.0.0.0 mask 240.0.0.0.

#### Syntax

```
ip pimsm crppreference <-1 - 255>
no ip pimsm crppreference
```

**<-1 - 255>** - The preference value for the local interface.

**no** - This command is used to reset the Candidate Rendezvous Point (CRP) for a particular PIM-SM interface to the default value.

### Default Setting

0

### Command Mode

Interface Config

## 8.6 IGMP Proxy Commands

The IGMP Proxy is used by IGMP Router (IPv4 system) to enable the system to issue IGMP host messages on behalf of hosts that the system discovered through standard IGMP router interfaces. With IGMP Proxy enabled, the system acts as proxy to all the hosts residing on its router interfaces.

### 8.6.1 Show Commands

#### 8.6.1.1 show ip igmp-proxy

This command displays a summary of the host interface status parameters. It displays the following parameters only when you enable IGMP Proxy.

<b>Syntax</b>
---------------

<code>show ip igmp-proxy</code>
---------------------------------

#### Default Setting

None

#### Command Mode

Privileged Exec

#### Display Message

**Interface index:** The interface number of the IGMP Proxy.

**Admin Mode:** States whether the IGMP Proxy is enabled or not. This is a configured value.

**Operational Mode:** States whether the IGMP Proxy is operationally enabled or not. This is a status parameter.

**Version:** The present IGMP host version that is operational on the proxy interface.

**Number of Multicast Groups:** States the number of multicast groups that are associated with the IGMP Proxy interface.

**Unsolicited Report Interval:** The time interval at which the IGMP Proxy interface sends unsolicited group membership report.

**Querier IP Address on Proxy Interface:** The IP address of the Querier, if any, in the network attached to the upstream interface (IGMP-Proxy interface).

**Older Version 1 Querier Timeout:** The interval used to timeout the older version 1 queriers.

**Older Version 2 Querier Timeout:** The interval used to timeout the older version 2 queriers.

**Proxy Start Frequency:** The number of times the IGMP Proxy has been stopped and started.

### 8.6.1.2 show ip igmp-proxy groups

This command displays information about the subscribed multicast groups that IGMP Proxy reported. It displays a table of entries with the following as the fields of each column.

<b>Syntax</b>
---------------

<b>show ip igmp-proxy groups</b>
----------------------------------

#### Default Setting

None

#### Command Mode

Privileged Exec

#### Display Message

**Interface:** The interface number of the IGMP Proxy.

**Group Address:** The IP address of the multicast group.

**Last Reporter:** The IP address of host that last sent a membership report.

**Up Time (in secs):** The time elapsed since last created.

**Member State:** The status of the entry. Possible values are IDLE\_MEMBER or DELAY\_MEMBER.

IDLE\_MEMBER - interface has responded to the latest group membership query for this group.

DELAY\_MEMBER - interface is going to send a group membership report to respond to a group membership query for this group.

Filter Mode

Possible values are Include or Exclude.

**Sources:** The number of sources attached to the multicast group.

### 8.6.1.3 show ip igmp-proxy groups detail

This command displays complete information about multicast groups that IGMP Proxy reported. It displays a table of entries with the following as the fields of each column.

<b>Syntax</b>
---------------

<b>show ip igmp-proxy groups detail</b>
---

#### Default Setting

None

**Command Mode**

Privileged Exec

**Display Message**

**Interface:** The interface number of the IGMP Proxy.

**Group Address:** The IP address of the multicast group.

**Last Reporter:** The IP address of host that last sent a membership report for the current group, on the network attached to the IGMP-Proxy interface (upstream interface).

**Up Time (in secs):** The time elapsed since last created.

**Member State:** The status of the entry. Possible values are IDLE\_MEMBER or DELAY\_MEMBER.

IDLE\_MEMBER - interface has responded to the latest group membership query for this group.

DELAY\_MEMBER - interface is going to send a group membership report to respond to a group membership query for this group.

**Filter Mode:** Possible values are include or exclude.

**Sources:** The number of sources attached to the multicast group.

**Group Source List:** The list of IP addresses of the sources attached to the multicast group.

**Expiry Time:** Time left before a source is deleted.

**8.6.1.4 show ip igmp-proxy interface**

This command displays a detailed list of the host interface status parameters. It displays the following parameters only when you enable IGMP Proxy.

<b>Syntax</b>	<b>show ip igmp-proxy interface</b>
---------------	-------------------------------------

**Default Setting**

None

**Command Mode**

Privileged Exec

**Display Message**

**Interface Index:** Shows the slot/port of the IGMP proxy.

**The column headings of the table associated with the interface are as follows:**

**Ver:** Shows the IGMP version.

**Query Rcvd:** Number of IGMP queries received.

**Report Rcvd:** Number of IGMP reports received.

**Report Sent:** Number of IGMP reports sent.

**Leaves Rcvd:** Number of IGMP leaves received.

**Leaves Sent:** Number of IGMP leaves sent.

## 8.6.2 Configuration Commands

### 8.6.2.1 ip igmp-proxy

This command enables the IGMP Proxy on the router. To enable the IGMP Proxy on the router, you must enable multicast forwarding. Also, make sure that there are no multicast routing protocols enabled on the router.

<b>Syntax</b>
---------------

<pre>ip igmp-proxy no ip igmp-proxy</pre>
---

**no** - This command disables the IGMP Proxy on the router.

#### Default Setting

Disabled

#### Command Mode

Interface Config

### 8.6.2.2 ip igmp-proxy reset-status

This command resets the host interface status parameters of the IGMP Proxy router. This command is valid only when you enable IGMP Proxy on the interface.

<b>Syntax</b>
---------------

<pre>ip igmp-proxy reset-status</pre>
---------------------------------------

**no** - This command returns an interface to the default value for DHCP filtering.

#### Default Setting

None

**Command Mode**

Interface Config

**8.6.2.3 ip igmp-proxy unsolicit-rprt-interval**

This command sets the unsolicited report interval for the IGMP Proxy router. This command is valid only when you enable IGMP Proxy on the interface. The value of <interval> can be 1-260 seconds.

**Syntax**

```
ip igmp-proxy unsolicit-rprt-interval <1-260>  
no ip igmp-proxy unsolicit-rprt-interval
```

**no** - This command resets the unsolicited report interval of the IGMP Proxy router to the default value.

**Default Setting**

None

**Command Mode**

Interface Config

## 9 IPV6 Commands

### 9.1 Tunnel Interface Commands

The commands in this section describe how to create, delete, and manage tunnel interfaces. Several different types of tunnels provide functionality to facilitate the transition of IPv4 networks to IPv6 networks. These tunnels are divided into two classes: configured and automatic. The distinction is that configured tunnels are explicitly configured with a destination or endpoint of the tunnel. Automatic tunnels, in contrast, infer the endpoint of the tunnel from the destination address of packets routed into the tunnel. To assign an IP address to the tunnel interface, please refer to “ip address” command. To assign an IPv6 address to the tunnel interface, please refer to “ipv6 address” command.

#### 9.1.1 Show Commands

##### 9.1.1.1 show interface tunnel

This command displays the parameters related to tunnel such as tunnel mode, tunnel source address and tunnel destination address.

<b>Syntax</b>
---------------

<code>show interface tunnel [&lt;0-7&gt;]</code>
--

#### Default Setting

None

#### Command Mode

Privileged Exec

#### Display Message

**If you do not specify a tunnel ID, the command shows the following information for each configured tunnel:**

**Tunnel ID:** Shows the tunnel identification number.

**Interface:** Shows the name of the tunnel interface.

**Tunnel Mode:** Shows the tunnel mode.

**Source Address:** Shows the source transport address of the tunnel.

**Destination Address:** Shows the destination transport address of the tunnel.

**If you specify a tunnel ID, the command shows the following information for the tunnel:**

**Interface Link Status:** Shows whether the link is up or down.

**MTU Size:** Shows the maximum transmission unit for packets on the interface.

**IPv6 Address/Length:** If you enable IPv6 on the interface and assign an address, the IPv6 address and prefix display.

## 9.1.2 Configuration Commands

### 9.1.2.1 interface tunnel

This command uses to enter the Interface Config mode for a tunnel interface. The <tunnel-id> range is 0 to 7.

**Syntax**

```
interface tunnel <0-7>  
no interface tunnel <0-7>
```

**no** - This command removes the tunnel interface and associated configuration parameters for the specified tunnel interface.

**Default Setting**

None

**Command Mode**

Global Config

### 9.1.2.2 tunnel source

This command specifies the source transport address of the tunnel, either explicitly or by reference to an interface.

**Syntax**

```
tunnel source {<ipv4-address> | <ethernet> <slot/port>}
```

<slot/port> - The Interface number.  
<ipv4-address> - A valid IP Address.

**Default Setting**

None

**Command Mode**

Interfacel Config



### 9.1.2.3 tunnel destination

This command specifies the destination transport address of the tunnel.

**Syntax**

```
tunnel destination {<ipv4-address>}
```

<ipv4-address> - A valid IP Address.

**Default Setting**

None

**Command Mode**

Interfacel Config

### 9.1.2.4 tunnel mode ipv6ip

This command specifies the mode of the tunnel.

**Syntax**

```
tunnel mode ipv6ip
```

**Default Setting**

None

**Command Mode**

Interfacel Config

## 9.2 Loopback Interface Commands

The commands in this section describe how to create, delete, and manage loopback interfaces. A loopback interface is always expected to be up. This interface can provide the source address for sent packets and can receive both local and remote packets. The loopback

interface is typically used by routing protocols. To assign an IP address to the loopback interface, please refer to “ip address” command. To assign an IPv6 address to the loopback interface, please refer to “ipv6 address” command.

## 9.2.1 Show Commands

### 9.2.1.1 show interface loopback

This command displays information about configured loopback interfaces.

<b>Syntax</b>
---------------

<b>show interface loopback [&lt;0-7&gt;]</b>
--

#### Default Setting

None

#### Command Mode

Privileged Exec

#### Display Message

**If you do not specify a loopback ID, the following information appears for each loopback**

**interface on the system:**

**Loopback ID:** Shows the loopback ID associated with the rest of the information in the row.

**Interface:** Shows the interface name.

**IP Address:** Shows the IPv4 address of the interface

**Received Packets:** Shows the number of packets received on this interface.

**Sent Packets:** Shows the number of packets transmitted from this interface.

**IPv6 Address:** Shows the IPv6 address of this interface

**If you specify a loopback ID, the following information appears:**

**Interface Link Status:** Shows whether the link is up or down.

**IP Address:** Shows the IPv4 address of the interface.

**IPv6 is enabled (disabled):** Show whether IPv6 is enabled on the interface

**IPv6 Address/Length is:** Shows the IPv6 address of the interface.

**MTU size:** Shows the maximum transmission size for packets on this interface, in bytes.

## 9.2.2 Configuration Commands

### 9.2.2.1 interface loopback

This command uses to enter the Interface Config mode for a loopback interface. The range of the loopback ID is 0 to 7.

**Syntax**

```
interface loopback <0-7>  
no interface loopback <0-7>
```

**no** - This command removes the loopback interface and associated configuration parameters for the specified loopback interface.

**Default Setting**

Disabled

**Command Mode**

Global Config

### 9.3 IPv6 Routing Commands

This section describes the IPv6 commands you use to configure IPv6 on the system and on the interfaces. This section also describes IPv6 management commands and show commands.

#### 9.3.1 Show Commands

##### 9.3.1.1 show ipv6 brief

This command displays the IPv6 status of forwarding mode and IPv6 unicast routing mode.

**Syntax**

```
show ipv6 brief
```

**Default Setting**

None

**Command Mode**

Privileged Exec

**Display Message**

**IPv6 Forwarding Mode:** Shows whether the IPv6 forwarding mode is enabled.

**IPv6 Unicast Routing Mode:** Shows whether the IPv6 unicast routing mode is enabled.

### 9.3.1.2 show ipv6 interface

This command displays the usability status of IPv6 interfaces.

#### Syntax

```
show ipv6 interface {brief | <slot/port> [prefix]}
```

<slot/port> - Valid slot and port number separated by forward slashes.

#### Default Setting

None

#### Command Mode

Privileged Exec

#### Display Message

**If you use the brief parameter, the following information displays for all configured IPv6 interfaces:**

**Interface** Shows the interface in slot/port format.

**IPv6 Routing Operational Mode** Shows whether the mode is enabled or disabled.

**IPv6 Address/Length** Shows the IPv6 address and length on interfaces with IPv6 enabled. If you specify an interface, the following information also appears.

**IPv6 is enabled** Appears if IPv6 is enabled on the interface.

**Routing Mode** Shows whether IPv6 routing is enabled or disabled.

**Administrative Mode** Shows whether the interface administrative mode is enabled or disabled.

**Interface Maximum Transmission Unit** Shows the MTU size, in bytes.

**Router Duplicate Address Detection Transmits** Shows the number of consecutive duplicate address detection probes to transmit.

**Router Advertisement NS Interval** Shows the interval, in milliseconds, between router advertisements for advertised neighbor solicitations.

**Router Lifetime Interval** Shows the router lifetime value of the interface in router advertisements

**Router Advertisement Reachable Time** Shows the amount of time, in milliseconds, to consider a neighbor reachable after neighbor discovery confirmation.

**Router Advertisement Interval** Shows the frequency, in seconds, that router advertisements are sent.

**Router Advertisement Managed Config Flag** Shows whether the managed configuration flag is set (enabled) for router advertisements on this interface.

**Router Advertisement Other Config Flag** Shows whether the other configuration flag is set (enabled) for router advertisements on this interface.

**Router Advertisement Suppress Flag** Shows whether router advertisements are suppressed (enabled) or sent (disabled).

**If an IPv6 prefix is configured on the interface, the following information also appears.**

**IPv6 Prefix** Shows the IPv6 prefix for the specified interface.

**Preferred Lifetime** Shows the amount of time the advertised prefix is a preferred prefix.

**Valid Lifetime** Shows the amount of time the advertised prefix is valid.

**Onlink Flag** Shows whether the onlink flag is set (enabled) in the prefix.

**Autonomous Flag** Shows whether the autonomous address-configuration flag (autoconfig) is set (enabled) in the prefix.

### 9.3.1.3 show ipv6 neighbors

This command displays information about the IPv6 neighbors.

<b>Syntax</b>	<b>show ipv6 neighbors</b>
---------------	----------------------------

#### Default Setting

None

#### Command Mode

Privileged Exec

#### Display Message

**Interface** Shows the interface in slot/port format.

**IPv6 Address** IPv6 address of neighbor or interface

**MAC Address** Link-layer Address

**IsRtr** Shows whether the neighbor is a router. If the value is TRUE, the neighbor is known to be a router, and FALSE otherwise. A value of FALSE might not mean Note that routers are not always known to be routers.

**Neighbor State** State of neighbor cache entry. Possible values are Incomplete, Reachable, Stale, Delay, Probe, and Unknown.

**Last Updated** Shows the system uptime when the information for the neighbor was last updated.

### 9.3.1.4 show ipv6 route

This command displays the IPv6 routing table The **<ipv6-address>** specifies a specific IPv6 address for which the best-matching route would be displayed. The **<ipv6-prefix/ipv6-prefix-length>** specifies a specific IPv6 network for which the matching route would be displayed. The **<interface>** specifies that the routes with next-hops on the **<interface>** be displayed. The **<protocol>** specifies the protocol that installed the routes. The **<protocol>** is one of the following keywords: **connected**, **ospf**, **static**. The **all** specifies that all routes including best and non-best routes are displayed. Otherwise, only the best routes are displayed.

**NOTE:** If you use the connected keyword for **<protocol>**, the all option is not available

because there are no best or non-best connected routes.

**Syntax**

```
show ipv6 route [{<ipv6-address> [<protocol>] | {{<ipv6-prefix/ipv6-prefix-length> | <slot/port>} [<protocol>] | <protocol> | summary} [all] | all}]
```

**Default Setting**

None

**Command Mode**

Privileged Exec

**Display Message**

**Code** The code for the routing protocol that created this routing entry.

**IPv6-Prefix/IPv6-Prefix-Length** The IPv6-Prefix and prefix-length of the destination IPv6 network corresponding to this route.

**Preference/Metric** The administrative distance (preference) and cost (metric) associated with this route. An example of this output is [1/0], where 1 is the preference and 0 is the metric.

**Tag** Displays the decimal value of the tag associated with a redistributed route, if it is not 0.

**Next-Hop** The outgoing router IPv6 address to use when forwarding traffic to the next router (if any) in the path toward the destination

**Interface** The outgoing router interface to use when forwarding traffic to the next destination.

### 9.3.1.5 show ipv6 route preferences

This command displays the preference value associated with the type of route. Lower numbers have a greater preference. A route with a preference of 255 cannot be used to forward traffic.

**Syntax**

```
show ipv6 route preferences
```

**Default Setting**

None

**Command Mode**

Privileged Exec

**Display Message**

**Local** Preference of directly-connected routes.

**Static** Preference of static routes.

**OSPF Intra** Preference of routes within the OSPF area.

**OSPF Inter** Preference of routes to other OSPF routes that are outside of the area.

**OSPF Ext T1** Preference of OSPF Type-1 external routes.  
**OSPF Ext T2** Preference of OSPF Type-2 external routes.  
**OSPF NSSA T1** Preference of OSPF NSSA Type 1 routes.  
**OSPF NSSA T2** Preference of OSPF NSSA Type 1 routes.

### 9.3.1.6 show ipv6 route summary

This command displays the summary of the routing table. Use all to display the count summary for all routes, including best and non-best routes. Use the command without parameters to display the count summary for only the best routes.

<b>Syntax</b>
---------------

<code>show ipv6 route summary [all]</code>
--

#### Default Setting

None

#### Command Mode

Privileged Exec

#### Display Message

**Connected Routes:** Total number of connected routes in the routing table

**Static Routes:** Shows whether the IPv6 unicast routing mode is enabled.

**OSPF Routes:** Total number of routes installed by OSPFv3 protocol.

**Number of Prefixes:** Summarizes the number of routes with prefixes of different lengths

**Total Routes:** Shows the total number of routes in the routing table.

### 9.3.1.7 show ipv6 vlan

This command displays IPv6 VLAN routing interface addresses.

<b>Syntax</b>
---------------

<code>show ipv6 vlan</code>
-----------------------------

#### Default Setting

None

#### Command Mode

Privileged Exec

#### Display Message

**MAC Address used by Routing VLANs:** Shows the MAC address.

The rest of the output for this command is displayed in a table with the following column headings:

**VLAN ID:** Shows the VLAN ID of a configured VLAN.

**Logical Interface:** Shows the interface in slot/port format that is associated with the VLAN ID.

**IPv6 Address/Prefix Length:** Shows the IPv6 prefix and prefix length associated with the VLAN ID.

### 9.3.1.8 show ipv6 traffic

This command displays traffic and statistics for IPv6 and ICMPv6. Specify a logical, loopback, or tunnel interface to view information about traffic on a specific interface. If you do not specify an interface, the command displays information about traffic on all interfaces.

#### Syntax

```
show ipv6 traffic [{<slot/port> | loopback <loopback-id> | tunnel <tunnel-id>}]
```

#### Default Setting

None

#### Command Mode

Privileged Exec

#### Display Message

**Total Datagrams Received:** Total number of input datagrams received by the interface, including those received in error.

**Received Datagrams Locally Delivered:** Total number of datagrams successfully delivered to IPv6 user-protocols (including ICMP). This counter increments at the interface to which these datagrams were addressed, which might not necessarily be the input interface for some of the datagrams.

**Received Datagrams Discarded Due To Header Errors:** Number of input datagrams discarded due to errors in their IPv6 headers, including version number mismatch, other format errors, hop count exceeded, errors discovered in processing their IPv6 options, etc.

**Received Datagrams Discarded Due To MTU:** Number of input datagrams that could not be forwarded because their size exceeded the link MTU of outgoing interface.

**Received Datagrams Discarded Due To No Route:** Number of input datagrams discarded because no route could be found to transmit them to their destination.

**Received Datagrams With Unknown Protocol:** Number of locally-addressed datagrams received successfully but discarded because of an unknown or unsupported protocol. This counter increments at the interface to which these datagrams were addressed, which might not be necessarily the input interface for some of the datagrams

**Received Datagrams Discarded Due To Invalid Address:** Number of input datagrams discarded because the IPv6 address in their IPv6 header's destination field was not a valid address to be received at this entity. This count includes invalid addresses (for example, ::0)



and unsupported addresses (for example, addresses with unallocated prefixes). For entities which are not IPv6 routers and therefore do not forward datagrams, this counter includes datagrams discarded because the destination address was not a local address.

**Received Datagrams Discarded Due To Truncated Data:** Number of input datagrams discarded because datagram frame didn't carry enough data.

**Received Datagrams Discarded Other:** Number of input IPv6 datagrams for which no problems were encountered to prevent their continue processing, but which were discarded (e.g., for lack of buffer space). Note that this counter does not include datagrams discarded while awaiting re-assembly.

**Received Datagrams Reassembly Required:** Number of IPv6 fragments received which needed to be reassembled at this interface. Note that this counter increments at the interface to which these fragments were addressed, which might not be necessarily the input interface for some of the fragments.

**Datagrams Successfully Reassembled:** Number of IPv6 datagrams successfully reassembled. Note that this counter increments at the interface to which these datagrams were addressed, which might not be necessarily the input interface for some of the fragments.

**Datagrams Failed To Reassemble:** Number of failures detected by the IPv6 reassembly algorithm (for whatever reason: timed out, errors, etc.). Note that this is not necessarily a count of discarded IPv6 fragments since some algorithms (notably the algorithm in by combining them as they are received. This counter increments at the interface to which these fragments were addressed, which might not be necessarily the input interface for some of the fragments

**Datagrams Forwarded:** Number of output datagrams which this entity received and forwarded to their final destinations. In entities which do not act as IPv6 routers, this counter will include only those packets which were Source-Routed via this entity, and the Source-Route processing was successful. Note that for a successfully forwarded datagram the counter of the outgoing interface increments.

**Datagrams Locally Transmitted:** Total number of IPv6 datagrams which local IPv6 user protocols (including ICMP) supplied to IPv6 in requests for transmission. Note that this counter does not include any datagrams counted in `ipv6IfStatsOutForwDatagrams`.

**Datagrams Transmit Failed:** Number of output IPv6 datagrams for which no problem was encountered to prevent their transmission to their destination, but which were discarded (e.g., for lack of buffer space). Note that this counter would include datagrams counted in `ipv6IfStatsOutForwDatagrams` if any such packets met this (discretionary) discard criterion.

**Fragments Created:** Number of output datagram fragments that have been generated as a result of fragmentation at this output interface.

**Datagrams Successfully Fragmented:** Number of IPv6 datagrams that have been successfully fragmented at this output interface

**Datagrams Failed To Fragment:** Number of IPv6 datagrams that have been discarded because they needed to be fragmented at this output interface but could not be.

**Multicast Datagrams Received:** Number of multicast packets received by the interface.

**Multicast Datagrams Transmitted:** Number of multicast packets transmitted by the interface.

**Total ICMPv6 messages received:** Total number of ICMP messages received by the interface which includes all those counted by `ipv6IfIcmpInErrors`. Note that this interface is the interface to which the ICMP messages were addressed which may not be necessarily the input interface for the messages.

**ICMPv6 Messages with errors:** Number of ICMP messages which the interface received but determined as having ICMP-specific errors (bad ICMP checksums, bad length, etc.).

**ICMPv6 Destination Unreachable Messages:** Number of ICMP Destination Unreachable

messages received by the interface.

**ICMPv6 Messages Prohibited Administratively:** Number of ICMP destination unreachable/communication administratively prohibited messages received by the interface.

**ICMPv6 Time Exceeded Messages:** Number of ICMP Time Exceeded messages received by the interface.

**ICMPv6 Parameter Problem Messages:** Number of ICMP Parameter Problem messages received by the interface.

**ICMPv6 messages with too big packets:** Number of ICMP Packet Too Big messages received by the interface.

**ICMPv6 Echo Request Messages Received:** Number of ICMP Echo (request) messages received by the interface.

**ICMPv6 Echo Reply Messages Received:** Number of ICMP Echo Reply messages received by the interface.

**ICMPv6 Router Solicit Messages Received:** Number of ICMP Router Solicit messages received by the interface.

**ICMPv6 Router Advertisement Messages Received:** Number of ICMP Router Advertisement messages received by the interface.

**ICMPv6 Neighbor Solicit Messages Received:** Number of ICMP Neighbor Solicit messages received by the interface.

**ICMPv6 Neighbor Advertisement Messages Received:** Number of ICMP Neighbor Advertisement messages received by the interface.

**ICMPv6 Redirect Messages Received:** Number of Redirect messages received by the interface.

**Transmitted:** Number of ICMPv6 Group Membership Query messages received by the interface.

**Total ICMPv6 Messages Transmitted:** Total number of ICMP messages which this interface attempted to send. Note that this counter includes all those counted by icmpOutErrors.

**ICMPv6 Messages Not Transmitted Due To Error:** Number of ICMP messages which this interface did not send due to problems discovered within ICMP such as a lack of buffers. This value should not include errors discovered outside the ICMP layer such as the inability of IPv6 to route the resultant datagram. In some implementations there may be no types of error which contribute to this counter's value.

**ICMPv6 Destination Unreachable Messages Transmitted:** Number of ICMP Destination Unreachable messages sent by the interface.

**ICMPv6 Messages Prohibited Administratively Transmitted:** Number of ICMP destination unreachable/communication administratively prohibited messages sent.

**ICMPv6 Time Exceeded Messages Transmitted:** Number of ICMP Time Exceeded messages sent by the interface.

**ICMPv6 Parameter Problem Messages Transmitted:** Number of ICMP Parameter Problem messages sent by the interface.

**ICMPv6 Packet Too Big Messages Transmitted:** Number of ICMP Packet Too Big messages sent by the interface.

**ICMPv6 Echo Request Messages Transmitted:** Number of ICMP Echo (request) messages sent by the interface. ICMP echo messages sent

**ICMPv6 Echo Reply Messages Transmitted:** Number of ICMP Echo Reply messages sent by the interface.

**ICMPv6 Router Solicit Messages Transmitted:** Number of ICMP Router Solicitation messages sent by the interface.

**ICMPv6 Router Advertisement Messages Transmitted:** Number of ICMP Router Advertisement messages sent by the interface.

**ICMPv6 Neighbor Solicit Messages Transmitted:** Number of ICMP Neighbor Solicitation

messages sent by the interface.

**ICMPv6 Neighbor Advertisement Messages Transmitted:** Number of ICMP Neighbor Advertisement messages sent by the interface.

**ICMPv6 Redirect Messages Received:** Number of Redirect messages sent. For a host, this object will always be zero, since hosts do not send redirects.

**ICMPv6 Group Membership Query Messages Received:** Number of ICMPv6 Group Membership Query messages sent.

**ICMPv6 Group Membership Response Messages Received:** Number of ICMPv6 group Membership Response messages sent.

**ICMPv6 Group Membership Reduction Messages Received:** Number of ICMPv6 Group Membership Reduction messages sent.

**ICMPv6 Duplicate Address Detects:** Number of duplicate addresses detected by the interface

### 9.3.1.9 show ipv6 neighbors static

This command display static neighbor cache table on the system.

<b>Syntax</b>
---------------

<b>show ipv6 neighbors static</b>
-----------------------------------

#### Default Setting

None

#### Command Mode

Privileged Exec

User Exec

#### Display Message

**IPv6 Address:** Specifies the IPv6 address of neighbor.

**MAC Address:** Specifies the MAC address of neighbor.

## 9.3.2 Configuration Commands

### 9.3.2.1 ipv6 forwarding

This command enables IPv6 forwarding on the switch.

<b>Syntax</b>
---------------

<b>ipv6 forwarding</b>
<b>no ipv6 forwarding</b>

**no** - This command disables IPv6 forwarding on the switch.

**Default Setting**

Enabled

**Command Mode**

Global Config

**9.3.2.2 ipv6 unicast-routing**

Use this command to enable the forwarding of IPv6 unicast packets.

**Syntax**

```
ipv6 unicast-routing  
no ipv6 unicast-routing
```

**no** – Use this command to disable the forwarding of IPv6 unicast packets.

**Default Setting**

Disabled

**Command Mode**

Global Config

**9.3.2.3 ipv6 enable**

Use this command to enable IPv6 routing on an interface, including a tunnel and loopback interface that has not been configured with an explicit IPv6 address. When you use this command, the interface is automatically configured with a link-local address. You do not need to use this command if you configured an IPv6 global address on the interface.

**Syntax**

```
ipv6 enable  
no ipv6 enable
```

**no** – Use this command to disable IPv6 routing on an interface.

### Default Setting

Disabled

### Command Mode

Interface Config

#### 9.3.2.4 ipv6 address

Use this command to configure an IPv6 address on an interface, including tunnel and loopback interfaces, and to enable IPv6 processing on this interface. You can assign multiple globally reachable addresses to an interface by using this command. You do not need to assign a linklocal address by using this command since one is automatically created. The <prefix> field consists of the bits of the address to be configured. The <prefix\_length> designates how many of the high-order contiguous bits of the address make up the prefix.

You can express IPv6 addresses in eight blocks. Also of note is that instead of a period, a colon now separates each block. For simplification, leading zeros of each 16 bit block can be omitted. One sequence of 16 bit blocks containing only zeros can be replaced with a double colon "::", but not more than one at a time (otherwise it is no longer a unique representation).

- **Dropping zeros:** 3ffe:ffff:100:f101:0:0:0:1 becomes 3ffe:ffff:100:f101::1
- **Local host:** 0000:0000:0000:0000:0000:0000:0000:0001 becomes ::1
- **Any host:** 0000:0000:0000:0000:0000:0000:0000:0000 becomes ::

The hexadecimal letters in the IPv6 addresses are not case-sensitive. An example of an IPv6 prefix and prefix length is 3ffe:1::1234/64.

The optional [eui-64] field designates that IPv6 processing on the interfaces was enabled using an EUI-64 interface ID in the low order 64 bits of the address. If you use this option, the value of <prefix\_length> must be 64 bits.

#### Syntax

```
ipv6 address <prefix> / <prefix_length> [eui64]  
no ipv6 address [<prefix> / <prefix_length>] [eui64]
```

**no** – Use this command to remove all IPv6 addresses on an interface or specified IPv6 address. The <prefix> parameter consists of the bits of the address to be configured. The <prefix\_length> designates how many of the high-order contiguous bits of the address comprise the prefix. The optional [eui-64] field designates that IPv6 processing on the interfaces was enabled using an EUI-64 interface ID in the low order 64 bits of the address. If you do not supply any parameters, the command deletes all the IPv6 addresses on an interface.

### Default Setting

None

**Command Mode**

Interface Config

**9.3.2.5 ipv6 route**

Use this command to configure an IPv6 static route. The <ipv6-prefix> is the IPv6 network that is the destination of the static route. The <prefix\_length> is the length of the IPv6 prefix — a decimal value (usually 0-64) that shows how many of the high-order contiguous bits of the address comprise the prefix (the network portion of the address). A slash mark must precede the <prefix\_length>. The <next-hop-address> is the IPv6 address of the next hop that can be used to reach the specified network. The <preference> parameter is a value the router uses to compare this route with routes from other route sources that have the same destination. The range for <preference> is 1 - 255, and the default value is 1. The interface <slot/port> identifies direct static routes from point-to-point and broadcast interfaces, and must be specified when using a link-local address as the next hop. A route with a preference of 255 cannot be used to forward traffic.

**Syntax**

```
ipv6 route <ipv6-prefix>/<prefix_length> {<next-hop-address> [<preference>] |  
    interface <slot/port> <next-hop-address> [<preference>]}  
no ipv6 route <ipv6-prefix>/<prefix_length> [{<next-hop-address> | interface  
    <slot/port> <next-hop-address> | <preference>}]
```

**no** – Use this command to delete an IPv6 static route. Use the command without the optional parameters to delete all static routes to the specified destination. Use the <preference> parameter to revert preference of a route to default preference.

**Default Setting**

Disabled

**Command Mode**

Global Config

**9.3.2.6 ipv6 mtu**

This command sets the maximum transmission unit (MTU) size, in bytes, of IPv6 packets on an interface. This command replaces the default or link MTU with a new MTU value.

**Syntax**

```
ipv6 mtu <1280-1500>  
no ipv6 mtu
```

**no** – This command resets maximum transmission unit value to default value.

**Default Setting**

0 or link speed (MTU value is 1500)

**Command Mode**

Interface Config

**9.3.2.7 ipv6 nd dad attempts**

This command sets the number of duplicate address detection probes transmitted. Duplicate address detection verifies that an IPv6 address on an interface is unique.

**Syntax**

```
ipv6 nd dad attempts <0 – 600>  
no ipv6 nd dad attempts
```

**no** – This command resets to number of duplicate address detection value to default value.

**Default Setting**

1

**Command Mode**

Interface Config

**9.3.2.8 ipv6 nd managed-config-flag**

This command sets the “managed address configuration” flag in router advertisements. When the value is true, end nodes use DHCPv6. When the value is false, end nodes automatically configure addresses.

**Syntax**

```
ipv6 nd managed-config-flag  
no ipv6 nd managed-config-flag
```

**no** – This command resets the “managed address configuration” flag in router advertisements to the default value.

**Default Setting**

False

**Command Mode**

Interface Config

**9.3.2.9 ipv6 nd ns-interval**

This command sets the interval between router advertisements for advertised neighbor solicitations, in milliseconds. An advertised value of 0 means the interval is unspecified.

**Syntax**

```
ipv6 nd ns-interval { <1000 – 3600000> | 0 }  
no ipv6 nd ns-interval
```

**no** – This command resets the neighbor solicit retransmission interval of the specified interface to the default value.

**Default Setting**

0

**Command Mode**

Interface Config

**9.3.2.10 ipv6 nd other-config-flag**

This command sets the “other stateful configuration” flag in router advertisements sent from the



interface.

**Syntax**

```
ipv6 nd other-config-flag  
no ipv6 nd other-config-flag
```

**no** – This command resets the “other stateful configuration” flag back to its default value in router advertisements sent from the interface.

**Default Setting**

False

**Command Mode**

Interface Config

**9.3.2.11 ipv6 nd ra-interval**

This command sets the transmission interval between router advertisements.

**Syntax**

```
ipv6 nd ra-interval <4 – 1800 >  
no ipv6 nd ra-interval
```

**no** – This command sets router advertisement interval to the default.

**Default Setting**

600

**Command Mode**

Interface Config

**9.3.2.12 ipv6 nd ra-lifetime**

This command sets the value, in seconds, that is placed in the Router Lifetime field of the router advertisements sent from the interface. The <lifetime> value must be zero, or it must be

an integer between the value of the router advertisement transmission interval and 9000. A value of zero means this router is not to be used as the default router.

**Syntax**

```
ipv6 nd ra-lifetime <lifetime>  
no ipv6 nd ra-lifetime
```

**no** – This command resets router lifetime to the default value.

**Default Setting**

1800

**Command Mode**

Interface Config

**9.3.2.13 ipv6 nd reachable-time**

This command sets the router advertisement time to consider a neighbor reachable after neighbor discovery confirmation. Reachable time is specified in milliseconds. A value of zero means the time is unspecified by the router.

**Syntax**

```
ipv6 nd reachable-time <0 - 4294967295>  
no ipv6 nd reachable-time
```

**no** – This command means reachable time is unspecified for the router.

**Default Setting**

0

**Command Mode**

Interface Config

**9.3.2.14 ipv6 nd suppress-ra**

This command suppresses router advertisement transmission on an interface.

**Syntax**

```
ipv6 nd suppress-ra  
no ipv6 nd suppress-ra
```

**no** –This command enables router transmission on an interface

**Default Setting**

Disabled

**Command Mode**

Interface Config

**9.3.2.15 ipv6 nd prefix**

This command sets the IPv6 prefixes to include in the router advertisement. The first optional parameter is the valid lifetime of the router, in seconds. You can specify a value or indicate that the lifetime value is infinite. The second optional parameter is the preferred lifetime of the router.

**Syntax**

```
ipv6 nd prefix <prefix/prefix_length> [{<0-4294967295> | infinite}  
      {<0-4294967295> | infinite}] [no-autoconfig off-link]  
no ipv6 nd prefix
```

**no** – This command sets prefix configuration to default values.

**Default Setting**

Valid-lifetime – 604800

Preferred-lifetime – 2592000

Autoconfig – enabled

On-link - enabled

**Command Mode**

Interface Config

### 9.3.2.16 ipv6 neighbor static

The user can add/delete a static neighbor into neighbor cache table.

**Syntax**

```
ipv6 neighbor static <ipv6-address> <mac-address>  
no ipv6 neighbor static <ipv6-address>
```

**no** – This command sets IPv6 neighbor configuration to default values.

**Default Setting**

None

**Command Mode**

Global Config

## 9.4 OSPFv3 Commands

This section describes the commands you use to configure OSPFv3, which is a link-state routing protocol that you use to route traffic within a network.

### 9.4.1 Show Commands

#### 9.4.1.1 show ipv6 ospf

This command displays information relevant to the OSPF router

**Syntax**

```
show ipv6 ospf
```

**Default Setting**

None

**Command Mode**

Privileged Exec

**Display Messages**

**NOTE:** Some of the information below displays only if you enable OSPF and configure certain features.

**Router ID** Is a 32 bit integer in dotted decimal format identifying the router, about which information is displayed. This is a configured value.

**OSPF Admin Mode** Shows whether the administrative mode of OSPF in the router is enabled or disabled. This is a configured value.

**ASBR Mode** Reflects whether the ASBR mode is enabled or disabled. Enable implies that the router is an autonomous system border router. Router automatically becomes an ASBR when it is configured to redistribute routes learnt from other protocol. The possible values for the ASBR status is enabled (if the router is configured to re-distribute routes learnt by other protocols) or disabled (if the router is not configured for the same).

**ABR Status** Shows whether the router is an OSPF Area Border Router.

**Exit Overflow Interval** Shows the number of seconds that, after entering Overflow State, a router will attempt to leave Overflow State.

**External LSA Count** Shows the number of external (LS type 5) link-state advertisements in the link-state database.

**External LSA Checksum** Shows the sum of the LS checksums of external link-state advertisements contained in the link-state database.

**New LSAs Originated** Shows the number of new link-state advertisements that have been originated.

**LSAs Received** Shows the number of link-state advertisements received determined to be new instantiations.

**External LSDB Limit** Shows the maximum number of non-default AS-external-LSAs entries that can be stored in the link-state database.

**Default Metric** Default value for redistributed routes.

**Default Route Advertise** Indicates whether the default routes received from other source protocols are advertised or not

**Always** Shows whether default routes are always advertised.

**Metric** Shows the metric for the advertised default routes. If the metric is not configured, this field is blank.

**Metric Type** Shows whether the routes are External Type 1 or External Type 2.

**Maximum Paths** Shows the maximum number of paths that OSPF can report for a given destination.

**Redistributing** This field is a heading and appears only if you configure the system to take routes learned from a non-OSPF source and advertise them to its peers.

**Source** Shows source protocol/routes that are being redistributed. Possible values are static, connected, or RIP.

**Metric** Shows the metric of the routes being redistributed.

**Metric Type** Shows whether the routes are External Type 1 or External Type 2.

**Tag** Shows the decimal value attached to each external route.

**Subnets** For redistributing routes into OSPF, the scope of redistribution for the specified protocol.

**Distribute-List** Shows the access list used to filter redistributed routes.

#### 9.4.1.2 show ip ospf abr

This command displays the internal OSPFv3 routes to reach Area Border Routers (ABR). This command takes no options.

<b>Syntax</b>
---------------

```
show ipv6 ospf abr
```

**Default Setting**

None

**Command Mode**

Privileged Exec, User Exec

**Display Messages****Type:** The type of the route to the destination. It can be either:

intra — Intra-area route

inter — Inter-area route

**Router ID:** Router ID of the destination**Cost:** Cost of using this route**Area ID:** The area ID of the area from which this route is learned.**Next Hop:** Next hop toward the destination**Next Hop Intf:** The outgoing router interface to use when forwarding traffic to the next hop.

### 9.4.1.3 show ipv6 ospf area

This command displays information about the area. The <areaid> identifies the OSPF area that is being displayed.

**Syntax**

```
show ipv6 ospf area <areaid>
```

**Default Setting**

None

**Command Mode**

Privileged Exec, User Exec

**Display Messages****AreaID** Is the area id of the requested OSPF area.**External Routing** Is a number representing the external routing capabilities for this area.**Spf Runs** Is the number of times that the intra-area route table has been calculated using this area's link-state database.**Area Border Router Count** The total number of area border routers reachable within this area.**Area LSA Count** Total number of link-state advertisements in this area's link-state database, excluding AS External LSAs.**Area LSA Checksum** A number representing the Area LSA Checksum for the specified AreaID excluding the external (LS type 5) link-state advertisements.**Stub Mode** Represents whether the specified Area is a stub area or not. The possible values

are enabled and disabled. This is a configured value.

**Import Summary LSAs** Shows whether to import summary LSAs (enabled).

**OSPF Stub Metric Value** Shows the metric value of the stub area. This field displays only if the area is a configured as a stub area.

**The following OSPF NSSA specific information displays only if the area is configured as an NSSA.**

**Import Summary LSAs** Shows whether to import summary LSAs into the NSSA.

**Redistribute into NSSA** Shows whether to redistribute information into the NSSA.

**Default Information Originate** Shows whether to advertise a default route into the NSSA

**Default Metric** Shows the metric value for the default route advertised into the NSSA.

**Default Metric Type** Shows the metric type for the default route advertised into the NSSA.

**Translator Role** Shows the NSSA translator role of the ABR, which is always or candidate.

**Translator Stability Interval** Shows the amount of time that an elected translator continues to perform its duties after it determines that its translator status has been deposed by another router.

**Translator State** Shows whether the ABR translator state is disabled, always, or elected.

#### 9.4.1.4 show ipv6 ospf asbr

This command displays the internal OSPFv3 routes to reach Autonomous System Boundary Routers (ASBR). This command takes no options.

##### Syntax

```
show ipv6 ospf asbr
```

##### Default Setting

None

##### Command Mode

Privileged Exec, User Exec

##### Display Messages

**Type:** The type of the route to the destination. It can be either:

intra — Intra-area route

inter — Inter-area route

**Router ID:** Router ID of the destination

**Cost:** Cost of using this route

**Area ID:** The area ID of the area from which this route is learned.

**Next Hop:** Next hop toward the destination

**Next Hop Intf:** The outgoing router interface to use when forwarding traffic to the next hop.

#### 9.4.1.5 show ipv6 ospf database

This command displays information about the link state database when OSPFv3 is enabled. If you do not enter any parameters, the command displays the LSA headers for all areas. Use the optional <areaid> parameter to display database information about a specific area. Use the other optional parameters to specify the type of link state advertisements to display. Use external to display the external LSAs. Use inter-area to display the inter-area LSAs. Use link to display the link LSAs. Use network to display the network LSAs. Use nssa-external to display NSSA external LSAs. Use prefix to display intra-area Prefix LSAs. Use router to display router LSAs. Use unknown area, unknown as, or unknown link to display unknown area, AS or link-scope LSAs, respectively. Use <lsid> to specify the link state ID (LSID). Use adv-router to show the LSAs that are restricted by the advertising router. Use selforiginate to display the LSAs in that are self originated. The information below is only displayed if OSPF is enabled.

**Syntax**

```
show ipv6 ospf [<areaid>] database [{external | inter-area {prefix | router} | link | network | nssa-external | prefix | router | unknown {area | as | link}}] [<lsid>] [{adv-router [<rtrid>] | self-originate}]
```

<areaid> - Configures to display database information about a specific area.

<lsid>- Specify the link state ID.

<rtrid>- Specify an IP Address.

**Default Setting**

None

**Command Mode**

Privileged Exec, User Exec

**Display Messages**

**Link Id:** Is a number that uniquely identifies an LSA that a router originates from all other self originated LSA's of the same LS type.

**Adv Router:** The Advertising Router. Is a 32 bit dotted decimal number representing the LSDB interface.

**Age:** Is a number representing the age of the link state advertisement in seconds.

**Sequence:** Is a number that represents which LSA is more recent.

**Checksum:** Is the total number LSA checksum.

**Options:** This is an integer. It indicates that the LSA receives special handling during routing calculations.

**Rtr Opt:** Router Options are valid for router links only.

**9.4.1.6 show ipv6 ospf database database-summary**

This command displays the number of each type of LSA in the database and the total number of LSAs in the database.



**Syntax**

```
show ipv6 ospf database database-summary
```

**Default Setting**

None

**Command Mode**

Privileged Exec, User Exec

**Display Messages**

**Router** Total number of router LSAs in the OSPFv3 link state database.

**Network** Total number of network LSAs in the OSPFv3 link state database.

**Inter-area Prefix** Total number of inter-area prefix LSAs in the OSPFv3 link state database.

**Inter-area Router** Total number of inter-area router LSAs in the OSPFv3 link state database.

**Type-7 Ext** Total number of NSSA external LSAs in the OSPFv3 link state database.

**Link** Total number of link LSAs in the OSPFv3 link state database.

**Intra-area Prefix** Total number of intra-area prefix LSAs in the OSPFv3 link state database.

**Link Unknown** Total number of link-source unknown LSAs in the OSPFv3 link state database.

**Area Unknown** Total number of area unknown LSAs in the OSPFv3 link state database.

**AS Unknown** Total number of as unknown LSAs in the OSPFv3 link state database.

**Type-5 Ext** Total number of AS external LSAs in the OSPFv3 link state database.

**Self-Originated Type-5** Total number of self originated AS external LSAs in the OSPFv3 link state database.

**Total** Total number of router LSAs in the OSPFv3 link state database.

**9.4.1.7 show ipv6 ospf interface**

This command displays the information for the IFO object or virtual interface tables.

**Syntax**

```
show ipv6 ospf interface {<slot/port> | loopback <0-7> | tunnel <0-7>}
```

**<slot/port>** - Interface number.

**<0-7>** - Loopback/Tunnel Interface ID.

**Default Setting**

None

**Command Mode**

Privileged Exec, User Exec

## Display Messages

**IP Address** Shows the IPv6 address of the interface.

**ifIndex** Shows the interface index number associated with the interface.

**OSPF Admin Mode** Shows whether the admin mode is enabled or disabled.

**OSPF Area ID** Shows the area ID associated with this interface.

**Router Priority** Shows the router priority. The router priority determines which router is the designated router.

**Retransmit Interval** Shows the frequency, in seconds, at which the interface sends LSA.

**Hello Interval** Shows the frequency, in seconds, at which the interface sends Hello packets.

**Dead Interval** Shows the amount of time, in seconds, the interface waits before assuming a neighbor is down.

**LSA Ack Interval** Shows the amount of time, in seconds, the interface waits before sending an LSA acknowledgement after receiving an LSA.

**Iftransit Delay Interval** Shows the number of seconds the interface adds to the age of LSA packets before transmission.

**Authentication Type** Shows the type of authentication the interface performs on LSAs it receives.

**Metric Cost** Shows the priority of the path. Low costs have a higher priority than high costs.

**OSPF MTU-ignore** Shows whether to ignore MTU mismatches in database descriptor packets sent from neighboring routers.

### **The following information only displays if OSPF is initialized on the interface:**

**OSPF Interface Type** Broadcast LANs, such as Ethernet and IEEE 802.5, take the value broadcast. The OSPF Interface Type will be 'broadcast'.

**State** The OSPF Interface States are: down, loopback, waiting, point-to-point, designated router, and backup designated router.

**Designated Router** The router ID representing the designated router.

**Backup Designated Router** The router ID representing the backup designated router.

**Number of Link Events** The number of link events.

**Metric Cost** The cost of the OSPF interface.

### 9.4.1.8 show ipv6 ospf interface brief

This command displays brief information for the IFO object or virtual interface tables.

<b>Syntax</b>
---------------

<pre>show ipv6 ospf interface brief</pre>
---

### Default Setting

None

### Command Mode

Privileged Exec, User Exec

## Display Messages

**Interface** Valid slot and port number separated by forward slashes.

**OSPF Admin Mode** States whether OSPF is enabled or disabled on a router interface. This is a configured value.

**OSPF Area ID** Represents the OSPF Area Id for the specified interface. This is a configured value.

**Router Priority** Shows the router priority. The router priority determines which router is the designated router.

**Hello Interval** Shows the frequency, in seconds, at which the interface sends Hello packets.

**Dead Interval** Shows the amount of time, in seconds, the interface waits before assuming a neighbor is down.

**Retransmit Interval** Shows the frequency, in seconds, at which the interface sends LSA.

**Retransmit Delay Interval** Shows the number of seconds the interface adds to the age of LSA packets before transmission.

**LSA Ack Interval** Shows the amount of time, in seconds, the interface waits before sending an LSA acknowledgement after receiving an LSA.

### 9.4.1.9 show ipv6 ospf interface stats

This command displays the statistics for a specific interface. The command only displays information if OSPF is enabled

<b>Syntax</b>
---------------

<b>show ipv6 ospf interface stats &lt;slot/port&gt;</b>
---

<slot/port> - Interface number.

## Default Setting

None

## Command Mode

Privileged Exec, User Exec

## Display Messages

**OSPFv3 Area ID** The area id of this OSPF interface.

**IP Address** The IP address associated with this OSPF interface.

**OSPFv3 Interface Events** The number of times the specified OSPF interface has changed its state, or an error has occurred.

**Virtual Events** The number of state changes or errors that occurred on this virtual link.

**Neighbor Events** The number of times this neighbor relationship has changed state, or an error has occurred.

**Packets Received** The number of OSPFv3 packets received on the interface.

**Packets Transmitted** The number of OSPFv3 packets sent on the interface.

**LSAs Sent** The total number of LSAs flooded on the interface.

**LSA Acks Received** The total number of LSA acknowledged from this interface.

**LSA Acks Sent** The total number of LSAs acknowledged to this interface.

**Sent Packets** The number of OSPF packets transmitted on the interface.

**Received Packets** The number of valid OSPF packets received on the interface.

**Discards** The number of received OSPF packets discarded because of an error in the packet or an error in processing the packet.

**Bad Version** The number of received OSPF packets whose version field in the OSPF header does not match the version of the OSPF process handling the packet.

**Virtual Link Not Found** The number of received OSPF packets discarded where the ingress interface is in a non-backbone area and the OSPF header identifies the packet as belonging to the backbone, but OSPF does not have a virtual link to the packet's sender.

**Area Mismatch** The number of OSPF packets discarded because the area ID in the OSPF header is not the area ID configured on the ingress interface.

**Invalid Destination Address** The number of OSPF packets discarded because the packet's destination IP address is not the address of the ingress interface and is not the AllDrRouters or AllSpfRouters multicast addresses.

**No Neighbor at Source Address** The number of OSPF packets dropped because the sender is not an existing neighbor or the sender's IP address does not match the previously recorded IP address for that neighbor. NOTE: Does not apply to Hellos.

**Invalid OSPF Packet Type** The number of OSPF packets discarded because the packet type field in the OSPF header is not a known type.

#### 9.4.1.10 show ipv6 ospf neighbor

This command displays information about OSPF neighbors. If you do not specify a neighbor IP address, the output displays summary information in a table. If you specify an interface or tunnel, only the information for that interface or tunnel displays. The **<ipaddr>** is the IP address of the neighbor, and when you specify this, detailed information about the neighbor displays. The information below only displays if OSPF is enabled and the interface has a neighbor.

##### Syntax

```
show ipv6 ospf neighbor [interface {<slot/port> | tunnel <0-7>}] [<ipaddr>]
```

**<ipaddr>** - IP address of the neighbor.

**<slot/port>** - Interface number.

##### Default Setting

None

##### Command Mode

Privileged Exec, User Exec

##### Display Messages

**If you do not specify an IP address, a table with the following columns displays for all neighbors or the neighbor associated with the interface that you specify:**

**Router ID** Shows the 4-digit dotted-decimal number of the neighbor router.

**Priority** Displays the OSPF priority for the specified interface. The priority of an interface is a priority integer from 0 to 255. A value of '0' indicates that the router is not eligible to become

the designated router on this network.

**Intf ID** Shows the interface ID of the neighbor.

**Interface** Shows the interface of the local router in slot/port format.

**State** Shows the state of the neighboring routers. Possible values are:

Down- initial state of the neighbor conversation - no recent information has been received from the neighbor.

Attempt - no recent information has been received from the neighbor but a more concerted effort should be made to contact the neighbor.

Init - an Hello packet has recently been seen from the neighbor, but bidirectional communication has not yet been established.

2 way - communication between the two routers is bidirectional.

Exchange start - the first step in creating an adjacency between the two neighboring routers, the goal is to decide which router is the master and to decide upon the initial DD sequence number.

Exchange - the router is describing its entire link state database by sending Database Description packets to the neighbor.

Loading - Link State Request packets are sent to the neighbor asking for the more recent LSAs that have been discovered (but not yet received) in the Exchange state.

Full - the neighboring routers are fully adjacent and they will now appear in router-LSAs and network-LSAs.

**Dead Time** Shows the amount of time, in seconds, to wait before the router assumes the neighbor is unreachable.

**If you specify an IP address for the neighbor router, the following fields display:**

**Interface** Shows the interface of the local router in slot/port format.

**Area ID** The area ID associated with the interface.

**Options** An integer value that indicates the optional OSPF capabilities supported by the neighbor. These are listed in its Hello packets. This enables received Hello Packets to be rejected (i.e., neighbor relationships will not even start to form) if there is a mismatch in certain crucial OSPF capabilities.

**Router Priority** Displays the router priority for the specified interface.

**Dead Timer Due** Shows the amount of time, in seconds, to wait before the router assumes the neighbor is unreachable.

**State** Shows the state of the neighboring routers.

**Events** The number of times this neighbor relationship has changed state, or an error has occurred.

**Retransmission Queue Length** Is an integer representing the current length of the retransmission queue of the specified neighbor router Id of the specified interface.

#### 9.4.1.11 show ipv6 ospf range

This command displays information about the area ranges for the specified <areaid>. The <areaid> identifies the OSPF area whose ranges are being displayed.

**Syntax**

```
show ipv6 ospf range <areaid>
```

<areaid> - The area id of the requested OSPF area

**Default Setting**

None

**Command Mode**

Privileged Exec, User Exec

**Display Messages**

**Area ID** The area id of the requested OSPF area.

**IP Address** An IP Address which represents this area range.

**Subnet Mask** A valid subnet mask for this area range.

**Lsdb Type** The type of link advertisement associated with this area range.

**Advertisement** The status of the advertisement. Advertisement has two possible settings: enabled or disabled.

**9.4.1.12 show ipv6 ospf stub table**

This command displays the OSPF stub table. The information bello will only be displayed if OSPF is initialized on the switch.

**Syntax**

```
show ipv6 ospf stub table
```

**Default Setting**

None

**Command Mode**

Privileged Exec, User Exec

**Display Messages**

**Area ID** Is a 32-bit identifier for the created stub area.

**Type of Service** Is the type of service associated with the stub metric. Only supports Normal TOS.

**Metric Val** The metric value is applied based on the TOS. It defaults to the least metric of the type of service among the interfaces to other areas. The OSPF cost for a route is a function of the metric value.

**Import Summary LSA** Controls the import of summary LSAs into stub areas.

#### 9.4.1.13 show ipv6 ospf virtual-link

This command displays the OSPF Virtual Interface information for a specific area and neighbor.

**Syntax**

```
show ip ospfv6 virtual-link <areaid> <neighbor>
```

<areaid> - Area ID.

<neighbor> - Neighbor's router ID.

**Default Setting**

None

**Command Mode**

Privileged Exec, User Exec

**Display Messages**

**Area ID** The area id of the requested OSPF area.

**Neighbor Router ID** The input neighbor Router ID.

**Hello Interval** The configured hello interval for the OSPF virtual interface.

**Dead Interval** The configured dead interval for the OSPF virtual interface.

**Iftransit Delay Interval** The configured transit delay for the OSPF virtual interface.

**Retransmit Interval** The configured retransmit interval for the OSPF virtual interface.

**Authentication Type** Shows the type of authentication the interface performs on LSAs it receives.

**State** The OSPF Interface States are: down, loopback, waiting, point-to-point, designated router, and backup designated router. This is the state of the OSPF interface.

**Neighbor State** The neighbor state.

#### 9.4.1.14 show ipv6 ospf virtual-link brief

This command displays the OSPFv4 Virtual Interface information for all areas in the system.

**Syntax**

```
show ipv6 ospf virtual-link brief
```

**Default Setting**

None

**Command Mode**

Privileged Exec, User Exec

### Display Messages

**Area Id** Is the area id of the requested OSPFv3 area.

**Neighbor** Is the neighbor interface of the OSPFv3 virtual interface.

**Hello Interval** Is the configured hello interval for the OSPFv3 virtual interface.

**Dead Interval** Is the configured dead interval for the OSPFv3 virtual interface.

**Retransmit Interval** Is the configured retransmit interval for the OSPFv3 virtual interface.

**Transit Delay** Is the configured transit delay for the OSPFv3 virtual interface.

## 9.4.2 Configuration Commands

### 9.4.2.1 Ipv6 ospf

This command enables OSPF on a router interface or loopback interface.

<b>Syntax</b>
---------------

<pre>ipv6 ospf no ipv6 ospf</pre>
-----------------------------------

**<no>** - This command disables OSPF on a router interface or loopback interface.

#### Default Setting

Disabled

#### Command Mode

Interface Config

### 9.4.2.2 ipv6 ospf areaid

This command sets the OSPF area to which the specified router interface belongs. The **<areaid>** is an IPv6 address, formatted as a 4-digit dotted-decimal number or a decimal value in the range of **<0-4294967295>**. The **<areaid>** uniquely identifies the area to which the interface connects. Assigning an area id, which does not exist on an interface, causes the area to be created with default values.

<b>Syntax</b>
---------------

<pre>ipv6 ospf areaid &lt;areaid&gt;</pre>
--



**<areaid>** - is an IPv6 address, formatted as a 4-digit dotted-decimal number or a decimal value in the range of <0-4294967295>.

**Default Setting**

None

**Command Mode**

Interface Config

**9.4.2.3 ipv6 ospf cost**

This command configures the cost on an OSPF interface. The <cost> parameter has a range of 1 to 65535.

**Syntax**

```
ipv6 ospf cost <1-65535>  
no ipv6 ospf cost
```

**<no>** - This command configures the default cost on an OSPF interface.

**Default Setting**

None

**Command Mode**

Interface Config

**9.4.2.4 ipv6 ospf dead-interval**

This command sets the OSPF dead interval for the specified interface. The value for <seconds> is a valid positive integer, which represents the length of time in seconds that a router's Hello packets have not been seen before its neighbor routers declare that the router is down. The value for the length of time must be the same for all routers attached to a common network. This value should be some multiple of the Hello Interval (i.e. 4). Valid values range for <seconds> is from 1 to 2147483647.

**Syntax**

```
ipv6 ospf dead-interval <seconds>
```

```
no ipv6 ospf dead-interval
```

**<no>** - This command sets the default OSPF dead interval for the specified interface.

**Default Setting**

40

**Command Mode**

Interface Config

**9.4.2.5 ipv6 ospf hello-interval**

This command sets the OSPF hello interval for the specified interface. The value for **<seconds>** is a valid positive integer, which represents the length of time in seconds. The value for the length of time must be the same for all routers attached to a network. Valid values for **<seconds>** range from 1 to 65535.

**Syntax**

```
ipv6 ospf hello-interval <seconds>  
no ipv6 ospf hello-interval
```

**<no>** - This command sets the default OSPF hello interval for the specified interface.

**Default Setting**

10

**Command Mode**

Interface Config

**9.4.2.6 ipv6 ospf mtu-ignore**

This command disables OSPF maximum transmission unit (MTU) mismatch detection. OSPF Database Description packets specify the size of the largest IP packet that can be sent without fragmentation on the interface. When a router receives a Database Description packet, it examines the MTU advertised by the neighbor. By default, if the MTU is larger than the router can accept, the Database Description packet is rejected and the OSPF adjacency is not established.

**Syntax**

```
ipv6 ospf mtu-ignore  
no ipv6 ospf mtu-ignore
```

<no> - This command enables the OSPF MTU mismatch detection.

**Default Setting**

Enabled

**Command Mode**

Interface Config

**9.4.2.7 ipv6 ospf network**

This command changes the default OSPF network type for the interface. Normally, the network type is determined from the physical IP network type. By default all Ethernet networks are OSPF type broadcast. Similarly, tunnel interfaces default to point-to-point. When an Ethernet port is used as a single large bandwidth IP network between two routers, the network type can be point-to-point since there are only two routers. Using point-to-point as the network type eliminates the overhead of the OSPF designated router election. It is normally not useful to set a tunnel to OSPF network type broadcast.

**Syntax**

```
ipv6 ospf network {broadcast | point-to-point}  
no ipv6 ospf network {broadcast | point-to-point}
```

<no> - This command sets the interface type to the default value.

**Default Setting**

Broadcast

**Command Mode**

Interface Config

**9.4.2.8 ipv6 ospf priority**

This command sets the OSPF priority for the specified router interface. The priority of the interface is a priority integer from 0 to 255. A value of 0 indicates that the router is not eligible to

become the designated router on this network.

**Syntax**

```
ipv6 ospf priority <0-255>  
no ipv6 ospf priority
```

<no> - This command sets the default OSPF priority for the specified router interface.

**Default Setting**

1, which is the highest router priority

**Command Mode**

Interface Config

**9.4.2.9 ipv6 ospf retransmit-interval**

This command sets the OSPF retransmit Interval for the specified interface. The retransmit interval is specified in seconds. The value for <seconds> is the number of seconds between link-state advertisement retransmissions for adjacencies belonging to this router interface. This value is also used when retransmitting database description and link-state request packets. Valid values range from 0 to 3600 (1 hour).

**Syntax**

```
ipv6 ospf retransmit-interval <seconds>  
no ipv6 ospf retransmit-interval
```

<no> - This command sets the default OSPF retransmit Interval for the specified interface.

**Default Setting**

5

**Command Mode**

Interface Config

**9.4.2.10 ipv6 ospf transmit-delay**

This command sets the OSPF Transit Delay for the specified interface. The transmit delay is specified in seconds. In addition, it sets the estimated number of seconds it takes to transmit a link state update packet over this interface. Valid values for <seconds> range from 1 to 3600 (1

hour).

**Syntax**

```
ipv6 ospf transmit-delay <seconds>  
no ipv6 ospf transmit-delay
```

<no> - This command sets the default OSPF Transit Delay for the specified interface.

**Default Setting**

1

**Command Mode**

Interface Config

**9.4.2.11 ipv6 router ospf**

Use this command to enter Router OSPFv3 Config mode.

**Syntax**

```
ipv6 router ospf
```

**Default Setting**

None

**Command Mode**

Global Config

**9.4.2.12 area default-cost (OSPFv3)**

This command configures the monetary default cost for the stub area. The operator must specify the area id and an integer value between 1-16777215.

**Syntax**

```
area <areaid> default-cost <1-16777215>
```

<areaid> - Area ID.

**Default Setting**

None

**Command Mode**

Router OSPFv3 Config

**9.4.2.13 area nssa (OSPFv3)**

This command configures the specified areaid to function as an NSSA.

**Syntax**

```
area <areaid> nssa  
no area <areaid> nssa
```

<areaid> - Area ID.

no - This command disables nssa from the specified area id.

**Default Setting**

None

**Command Mode**

Router OSPFv3 Config

**9.4.2.14 area nssa default-info-originate (OSPFv3)**

This command configures the metric value and type for the default route advertised into the NSSA. The optional metric parameter specifies the metric of the default route and is to be in a range of 1-16777214. If no metric is specified, the default value is 10. The metric type can be comparable (nssa-external 1) or non-comparable (nssa-external 2).

**Syntax**

```
area <areaid> nssa default-info-originate [<1-16777215>] [{comparable |  
non-comparable}]  
no area <areaid> nssa default-info-originate [<1-16777215>] [{comparable |  
non-comparable}]
```

<areaid> - Area ID.

**<1-16777215>** - The metric of the default route. The range is 1 to 16777215.  
**comparable** - It's NSSA-External 1.  
**non-comparable** - It's NSSA-External 2.  
**no** - This command disables the default route advertised into the NSSA.

**Default Setting**

None

**Command Mode**

Router OSPFv3 Config

**9.4.2.15 area nssa no-redistribute (OSPFv3)**

This command configures the NSSA ABR so that learned external routes will not be redistributed to the NSSA.

**Syntax**

```
area <areaid> nssa no-redistribute  
no area <areaid> nssa no-redistribute
```

**<areaid>** - Area ID.

**no** - This command disables the NSSA ABR so that learned external routes are redistributed to the NSSA.

**Default Setting**

None

**Command Mode**

Router OSPFv3 Config

**9.4.2.16 area nssa no-summary (OSPFv3)**

This command configures the NSSA so that summary LSAs are not advertised into the NSSA

**Syntax**

```
area <areaid> nssa no-summary  
no area <areaid> nssa no-summary
```

**<areaid>** - Area ID.

**no** - This command disables nssa from the summary LSAs.

#### Default Setting

None

#### Command Mode

Router OSPFv3 Config

### 9.4.2.17 area nssa translator-role (OSPFv3)

This command configures the translator role of the NSSA. A value of *always* causes the router to assume the role of the translator the instant it becomes a border router and a value of *candidate* causes the router to participate in the translator election process when it attains border router status.

#### Syntax

```
area <areaid> nssa translator-role {always | candidate}
no area <areaid> nssa translator-role
```

**<areaid>** - Area ID.

**always** - A value of *always* will cause the router to assume the role of the translator when it becomes a border router.

**candidate** - a value of *candidate* will cause the router to participate in the translator election process when it attains border router status.

**no** - This command disables the nssa translator role from the specified area id.

#### Default Setting

None

#### Command Mode

Router OSPFv3 Config

### 9.4.2.18 area nssa translator-stab-intv (OSPFv3)

This command configures the translator stability interval of the NSSA. The *<stabilityinterval>* is the period of time that an elected translator continues to perform its duties after it determines that its translator status has been deposed by another router.



**Syntax**

```
area <areaid> nssa translator-stab-intv <0-3600>
no area <areaid> nssa translator-stab-intv
```

**<areaid>** - Area ID.

**<0-3600>** - The range is 0 to 3600.

**no** - Disables the nssa translator's <stabilityinterval> from the specified area id.

**Default Setting**

None

**Command Mode**

Router OSPFv3 Config

**9.4.2.19 area range (OSPFv3)**

This command creates a specified area range for a specified NSSA. The **<ipv6-prefix>** is a valid IPv6 address. The **<prefix-length>** is a valid subnet mask. The LSDB type must be specified by either **summarylink** or **nssaexternallink**, and the advertising of the area range can be allowed or suppressed.

**Syntax**

```
area <areaid> range <ipv6-prefix>/<prefix-length> {summarylink | nssaexternallink}
[advertise | not-advertise]
no area <areaid> range <ipv6-prefix>/<prefix-length>
```

**<areaid>** - Area ID.

**<ipv6-prefix>** - IP Address.

**<prefix-length>** - The subnetmask.

**summarylink** - The lsdb type. The value is **summarylink** or **nssaexternallink**

**nssaexternallink** - The lsdb type. The value is **summarylink** or **nssaexternallink**

**advertise** - Allow advertising the specified area range.

**not-advertise** - Disallow advertising the specified area range.

**<no>** - This command deletes a specified area range.

**Default Setting**

None

**Command Mode**

Router OSPFv3 Config

#### 9.4.2.20 area stub (OSPFv3)

This command creates a stub area for the specified area ID. A stub area is characterized by the fact that AS External LSAs are not propagated into the area. Removing AS External LSAs and Summary LSAs can significantly reduce the link state database of routers within the stub area.

##### Syntax

```
area <areaid> stub  
no area <areaid> stub
```

**<areaid>** - Area ID.

**<no>** - This command deletes a stub area for the specified area ID.

##### Default Setting

None

##### Command Mode

Router OSPFv3 Config

#### 9.4.2.21 area stub no-summary (OSPFv3)

This command disables the import of Summary LSAs for the stub area identified by <areaid>.

##### Syntax

```
area <areaid> stub no-summary  
no area <areaid> stub no-summary
```

**<areaid>** - Area ID.

**<no>** - This command sets the Summary LSA import mode to the default for the stub area identified by <areaid>.

##### Default Setting

Enabled

##### Command Mode

Router OSPFv3 Config

#### 9.4.2.22 area virtual-link (OSPFv3)

This command creates the OSPF virtual interface for the specified <areaid> and <neighbor>. The <neighborid> parameter is the Router ID of the neighbor.

##### Syntax

```
area <areaid> virtual-link <neighborid>  
no area <areaid> virtual-link <neighborid>
```

<areaid> - Area ID.

<neighborid> - Router ID of the neighbor.

<no> - This command deletes the OSPF virtual interface from the given interface, identified by <areaid> and <neighborid>. The <neighborid> parameter is the Router ID of the neighbor.

##### Default Setting

The default authentication type is none.

##### Command Mode

Router OSPFv3 Config

#### 9.4.2.23 area virtual-link dead-interval (OSPFv3)

This command configures the dead interval for the OSPF virtual interface on the virtual interface identified by <areaid> and <neighborid>.

##### Syntax

```
area <areaid> virtual-link <neighborid> dead-interval <1-65535>  
no area <areaid> virtual-link <neighborid> dead-interval
```

<areaid> - Area ID.

<neighborid> - Router ID of the neighbor.

<1-65535> - The range of the dead interval is 1 to 65535.

<no> - This command configures the default dead interval for the OSPF virtual interface on the virtual interface identified by <areaid> and <neighbor>. The <neighbor> parameter is the Router ID of the neighbor.

##### Default Setting

40 seconds.

### Command Mode

Router OSPFv3 Config

#### 9.4.2.24 area virtual-link hello-interval (OSPFv3)

This command configures the hello interval for the OSPF virtual interface on the interface identified by **<areaid>** and **<neighborid>**.

##### Syntax

```
area <areaid> virtual-link <neighborid> hello-interval <1-65535>
no area <areaid> virtual-link <neighborid> hello-interval
```

**<areaid>** - Area ID.

**<neighborid>** - Router ID of the neighbor.

**<1-65535>** - The range of the hello interval is 1 to 65535.

**<no>** - This command configures the default hello interval for the OSPF virtual interface on the interface identified by **<areaid>** and **<neighborid>**.

### Default Setting

10 seconds.

### Command Mode

Router OSPFv3 Config

#### 9.4.2.25 area virtual-link retransmit-interval (OSPFv3)

This command configures the retransmit interval for the OSPF virtual interface on the interface identified by **<areaid>** and **<neighborid>**.

##### Syntax

```
area <areaid> virtual-link <neighborid> retransmit-interval <0-3600>
no area <areaid> virtual-link <neighborid> retransmit-interval
```

**<areaid>** - Area ID.

**<neighborid>** - Router ID of the neighbor.

**<0-3600>** - The range of the retransmit interval is 0 to 3600.

**<no>** - This command configures the default retransmit interval for the OSPF virtual

interface on the interface identified by <areaid> and <neighborid>.

**Default Setting**

5 seconds.

**Command Mode**

Router OSPFv3 Config

**9.4.2.26 area virtual-link transmit-delay (OSPFv3)**

This command configures the transmit delay for the OSPF virtual interface on the virtual interface identified by <areaid> and <neighborid>.

**Syntax**

```
area <areaid> virtual-link <neighborid> transmit-delay <0-3600>
no area <areaid> virtual-link <neighborid> transmit-delay
```

<areaid> - Area ID.

<neighborid> - Router ID of the neighbor.

<0-3600> - The range of the transmit delay is 0 to 3600.

<no> - This command configures the default transmit delay for the OSPF virtual interface on the virtual interface identified by <areaid> and <neighborid>.

**Default Setting**

1 second.

**Command Mode**

Router OSPFv3 Config

**9.4.2.27 default-information originate (OSPFv3)**

This command is used to control the advertisement of default routes.

**Syntax**

```
default-information originate [always] [metric <1-16777215>] [metric-type {1 | 2}]
no default-information originate [metric] [metric-type]
```

[always] - Sets the router advertise 0.0.0.0/0.0.0.0.

**metric** - The range of the metric is 1 to 16777215.

**metric type** - The value of metric type is type 1 or type 2.

**<no>** - This command configures the default advertisement of default routes.

#### Default Setting

Metric: unspecified

Type: 2

#### Command Mode

Router OSPFv3 Config

#### 9.4.2.28 default-metric (OSPFv3)

This command is used to set a default for the metric of distributed routes.

##### Syntax

```
default-metric <1-16777215>  
no default-metric
```

**<1-16777215>** - The range of default metric is 1 to 16777215.

**<no>** - This command is used to set a default for the metric of distributed routes.

#### Default Setting

None

#### Command Mode

Router OSPFv3 Config

#### 9.4.2.29 distance ospf (OSPFv3)

This command sets the route preference value of OSPF in the router. Lower route preference values are preferred when determining the best route. The type of OSPF can be intra, inter, type-1, or type-2. The OSPF specification (RFC 2328) requires that preferences must be given to the routes learned via OSPF in the following order: intra < inter < type-1 < type-2. The <preference> range is 1 to 255. A route with a preference of 255 cannot be used to forward traffic.

##### Syntax

```
distance ospf {intra | inter | type1 | type2} <preference>  
no distance ospf {intra | inter | type1 | type2}
```

**<preference>** - The range for intra is 1 to 252. The range for inter is 2 to 253. The range for type1 is 3 to 254. The range for type2 is 4 to 255.

**<no>** - This command sets the default route preference value of OSPF in the router.

### Default Setting

Intra is 8.

Inter is 10.

Type 1 is 13.

Type 2 is 150.

### Command Mode

Router OSPFv3 Config

#### 9.4.2.30 enable (OSPFv3)

This command resets the default administrative mode of OSPF in the router (active).

#### Syntax

```
enable  
no enable
```

**<no>** - This command sets the administrative mode of OSPF in the router to inactive.

### Default Setting

Enabled

### Command Mode

Router OSPFv3 Config

#### 9.4.2.31 exit-overflow-interval (OSPFv3)

This command configures the exit overflow interval for OSPF. It describes the number of seconds after entering Overflow state that a router will wait before attempting to leave the Overflow State. This allows the router to again originate non-default AS-external-LSAs. When

set to 0, the router will not leave Overflow State until restarted.

**Syntax**

```
exit-overflow-interval <0-2147483647>  
no exit-overflow-interval
```

<0-2147483647> - The range of exit overflow interval for OSPF is 0 to 2147483674.  
<no> - This command configures the default exit overflow interval for OSPF.

**Default Setting**

0.

**Command Mode**

Router OSPFv3 Config

**9.4.2.32 external-lsdb-limit (OSPFv3)**

This command configures the external LSDB limit for OSPF. If the value is -1, then there is no limit. When the number of non-default AS-external-LSAs in a router's link-state database reaches the external LSDB limit, the router enters overflow state. The router never holds more than the external LSDB limit non-default AS-external-LSAs in its database. The external LSDB limit MUST be set identically in all routers attached to the OSPF backbone and/or any regular OSPF area.

**Syntax**

```
external-lsdb-limit <-1-2147483647>  
no external-lsdb-limit
```

<-1-2147483647> - The range of external LSDB limit for OSPF is -1 to 2147483674.  
<no> - This command configures the default external LSDB limit for OSPF.

**Default Setting**

-1.

**Command Mode**

Router OSPFv3 Config



### 9.4.2.33 maximum-paths (OSPFv3)

This command sets the number of paths that OSPF can report for a given destination where <maxpaths> is platform dependent.

#### Syntax

```
maximum-paths <1-2>  
no maximum-paths
```

<1-2> - The maximum number of paths that OSPF can report for a given destination. The range of the value is 1 to 2.

<no> - This command resets the number of paths that OSPF can report for a given destination back to its default value.

#### Default Setting

1

#### Command Mode

Router OSPFv3 Config.

### 9.4.2.34 redistribute (OSPFv3)

This command configures the OSPFv3 protocol to allow redistribution of routes from the specified source protocol/routers.

#### Syntax

```
redistribute {static | connected} [metric <0-16777214>] [metric-type {1 | 2}] [tag  
<0-4294967295>]  
no redistribute { static | connected} [metric] [metric-type] [tag]
```

<0-16777214> - The range of metric is 0 to 16777214.

<0-4294967295> - The range of tag is 0 to 4294967295.

#### Default Setting

Metric is unspecified.

Type is 2.

Tag is 0.

**Command Mode**

Router OSPFv3 Config

**9.4.2.35 router-id (OSPFv3)**

This command sets a 4-digit dotted-decimal number uniquely identifying the router ospf id.

**Syntax**

```
router-id <ipaddress>
```

< ipaddress > - IP Address.

**Default Setting**

None.

**Command Mode**

Router OSPFv3 Config

**9.5 RIPng Commands**

RIPng is intended to allow routers to exchange information for computing routes through an IPv6-based network. RIPng is a distance vector protocol. RIPng should be implemented only in routers. Any router that uses RIPng is assumed to have interfaces to one or more networks, otherwise it isn't really a router. These are referred to as its directly-connected networks. The protocol relies on access to certain information about each of these networks, the most important of which is its metric. The RIPng metric of a network is an integer between 1 and 15, inclusive. It is set in some manner not specified in this protocol; however, given the maximum path limit of 15, a value of 1 is usually used. Implementations should allow the system administrator to set the metric of each network. In addition to the metric, each network will have an IPv6 destination address prefix and prefix length associated with it. These are to be set by the system administrator in a manner not specified in this protocol.

**9.5.1 Show Commands****9.5.1.1 show ipv6 rip**

This command displays information relevant to the RIPng router

**Syntax**

```
show ipv6 rip
```

**Default Setting**

None

**Command Mode**

Privileged Exec

**Display Messages**

**RIPng Admin Mode:** Select enable or disable from the pulldown menu. If you select enable RIPng will be enabled for the switch. The default is disabled.

**Split Horizon Mode:** Select none, simple or poison reverse from the pulldown menu. Split horizon is a technique for avoiding problems caused by including routes in updates sent to the router from which the route was originally learned. The options are: None - no special processing for this case. Simple - a route will not be included in updates sent to the router from which it was learned. Poisoned reverse - a route will be included in updates sent to the router from which it was learned, but the metric will be set to infinity. The default is simple.

**Auto Summary Mode:** Select enable or disable from the pulldown menu. If you select enable groups of adjacent routes will be summarized into single entries, in order to reduce the total number of entries. The default is enabled.

**Host Routes Accept Mode:** Select enable or disable from the pulldown menu. If you select enable the router will be accept host routes. The default is enabled.

**Global route changes:** The number of route changes made to the IP Route Database by RIPng. This does not include the refresh of a route's age.

**Global queries:** The number of responses sent to RIPng queries from other systems.  
**Default Metric Sets** a default for the metric of redistributed routes. This field displays the default metric if one has already been set or blank if not configured earlier. The valid values are (1 to 15).

**Default Metric:** Sets a default for the metric of redistributed routes. This field displays the default metric if one has already been set or blank if not configured earlier. The valid values are (1 to 15).

**Default Route Advertise:** The default route.

## 9.5.2 Configuration Commands

### 9.5.2.1 enable

This command resets the default administrative mode of RIPng in the router (active).

**Syntax**

```
enable  
no enable
```

**<no>** - This command sets the administrative mode of RIPng in the router to inactive.

**Default Setting**

Enabled

**Command Mode**

IPv6 Router RIP Config

**9.5.2.2 ipv6 rip**

This command enables RIPng on a router interface.

**Syntax**

```
ipv6 rip
no ipv6 rip
```

**<no>** - This command disables RIPng on a router interface.

**Default Setting**

Disabled

**Command Mode**

Interface Config

**9.5.2.3 default-information originate**

This command is used to set the advertisement of default routes.

**Syntax**

```
default-information originate
no default-information originate
```

**<no>** - This command is used to cancel the advertisement of default routes.

**Default Setting**

Disabled

**Command Mode**

IPv6 Router RIP Config

#### 9.5.2.4 default-metric

This command is used to set a default for the metric of distributed routes.

**Syntax**

```
default-metric <1-15>  
no default-metric
```

<1-15> - a value for default-metric.

<no> - This command is used to reset the default metric of distributed routes to its default value.

**Default Setting**

Not configured

**Command Mode**

IPv6 Router RIP Config

#### 9.5.2.5 distance rip

This command sets the route preference value of RIPng in the router. Lower route preference values are preferred when determining the best route.

**Syntax**

```
distance rip <1-255>  
no distance rip
```

<1-255> - the value for distance.

<no> - This command sets the default route preference value of RIPng in the router.

**Default Setting**

15

**Command Mode**

IPv6 Router RIP Config

#### 9.5.2.6 split-horizon

This command sets the RIPngplit horizon mode. None mode will not use RIPngplit horizon mode. Simple mode will be that a route is not advertised on the interface over which it is learned. Poison mode will be that routes learned over this interface should be re-advertised on the interface with a metric of infinity (16)

**Syntax**

```
split-horizon {none | simple | poison}
no split-horizon
```

- none** - This command sets without using RIPngplit horizon mode.
- simple** - This command sets to use simple split horizon mode.
- poison** - This command sets to use poison reverse mode.
- no** - This command cancel to set the RIPngplit horizon mode and sets none mode.

**Default Setting**

Simple

**Command Mode**

IPv6 Router RIP Config

**9.5.2.7 redistribute**

This command configures RIPng protocol to redistribute routes from the specified source protocol/routers. There are five possible match options. When you submit the command redistribute ospf match <matchtype> the match-type or types specified are added to any match types presently being redistributed. Internal routes are redistributed by default. Source protocols have OSPF, Static, and Connected. Match types will have internal, external 1, external 2, nssa-external 1, and nssa-external 2.

**Syntax**
**Format for OSPF as source protocol:**

```
redistribute ospf [metric <1-15>] [match [internal] [external 1] [external 2]
[nssa-external 1] [nssa-external 2]]
```

**Format for other source protocols:**

```
redistribute {static | connected} [metric <1-15>]
no redistribute {ospf | static | connected} [metric] [match [internal] [external 1]
[external 2] [nssa-external 1] [nssa-external 2]]
```

- <1 - 15>** - a value for metric.
- no** - This command de-configures RIPng protocol to redistribute routes from the specified source protocol/routers.

**Default Setting**

Metric – not-configured

Match – internal

**Command Mode**

IPv6 Router RIP Config

**9.5.2.8 ipv6 rip timer**

The user can go to the CLI Global Configuration Mode to set ipv6 rip timer, use the **ipv6 rip timer {update|garbage|info} <5-2147483647>** global configuration command. Use the **no ipv6 rip timer {update|garbage|info}** return to the default value.

**Syntax**

```
ipv6 rip timer {update|garbage|info} <5-2147483647>  
no ipv6 rip timer {update|garbage|info}
```

**update** - This command sets to the RIPng update time.

**garbage** - This command sets to the RIPng garbage time.

**info** - This command sets to the RIPng info time.

**no** - This command sets the RIPng timer to default value.

**Default Setting**

**update** - the default value is 30 (seconds)

**garbage** - the default value is 120 (seconds)

**info** - the default value is 180 (seconds)

**Command Mode**

Global Config

**9.5.2.9 ipv6 rip passive-interface**

The user can go to the CLI Interface Configuration Mode to set ipv6 rip passive, use the **ipv6 rip passive-interface** interface configuration command. Use the **no ipv6 rip passive-interface** return to the default value.

**Syntax**

```
ipv6 rip passive-interface  
no ipv6 rip passive-interface
```

**no** - This command sets the RIPng timer to default value.

**Default Setting**

disable

**Command Mode**

Interface mode

## 9.6 DHCPv6 Commands

This section describes the command you use to configure the DHCPv6 server on the system and to view DHCPv6 information.

### 9.6.1 Show Commands

#### 9.6.1.1 show ipv6 dhcp

This command displays the DHCPv6 server name and status.

**Syntax**

```
show ipv6 dhcp
```

**Default Setting**

None

**Command Mode**

Privileged Exec

**Display Message**

**DHCPv6 is Enabled (Disabled)** Shows the status of the DHCPv6 server.

**Server DUID:** If configured, shows the DHCPv6 unique identifier



### 9.6.1.2 show ipv6 dhcp statistics

This command displays the IPv6 DHCP statistics for all interfaces.

<b>Syntax</b>
---------------

<b>show ipv6 dhcp statistics</b>
----------------------------------

#### Default Setting

None

#### Command Mode

Privileged Exec

#### Display Message

**DHCPv6 is Enabled (Disabled)** Shows the status of the DHCPv6 server.

**Server DUID:** If configured, shows the DHCPv6 unique identifier

**DHCPv6 Solicit Packets Received** Number of solicit received statistics.

**DHCPv6 Request Packets Received** Number of request received statistics.

**DHCPv6 Confirm Packets Received** Number of confirm received statistics.

**DHCPv6 Renew Packets Received** Number of renew received statistics.

**DHCPv6 Rebind Packets Received** Number of rebind received statistics.

**DHCPv6 Release Packets Received** Number of release received statistics.

**DHCPv6 Decline Packets Received** Number of decline received statistics.

**DHCPv6 Inform Packets Received** Number of inform received statistics.

**DHCPv6 Relay-forward Packets Received** Number of relay forward received statistics.

**DHCPv6 Relay-reply Packets Received** Number of relay-reply received statistics.

**DHCPv6 Malformed Packets Received** Number of malformed packets statistics.

**Received DHCPv6 Packets Discarded** Number of DHCP discarded statistics.

**Total DHCPv6 Packets Received** Total number of DHCPv6 received statistics.

**DHCPv6 Advertisement Packets Transmitted** Number of advertise sent statistics.

**DHCPv6 Reply Packets Transmitted** Number of reply sent statistics.

**DHCPv6 Reconfig Packets Transmitted** Number of reconfigure sent statistics.

**DHCPv6 Relay-reply Packets Transmitted** Number of relay-reply sent statistics.

**DHCPv6 Relay-forward Packets Transmitted** Number of relay-forward sent statistics.

**Total DHCPv6 Packets Transmitted** total number of DHCPv6 sent statistics.

### 9.6.1.3 show ipv6 dhcp interface

This command displays DHCPv6 information for all relevant interfaces or the specified interface. If you specify an interface, you can use the optional *statistics* parameter to view statistics for the specified interface.

**Syntax**

```
show ipv6 dhcp interface <slot/port> [statistics]
```

**Default Setting**

None

**Command Mode**

Privileged Exec

**Display Message**

**DHCPv6 is Enabled (Disabled)** Shows the status of the DHCPv6 server.

**Server DUID:** If configured, shows the DHCPv6 unique identifier

**IPv6 Interface** Shows the interface name in *<slot/port>* format.

**Mode** Shows whether the interface is a IPv6 DHCP relay or server.  
If the interface mode is server, the following information displays.

**Pool Name** Shows the pool name specifying information for DHCPv6 server distribution to DHCPv6 clients.

**Server Preference** Shows the preference of the server.

**Option Flags** Shows whether rapid commit is enabled.  
If the interface mode is relay, the following information displays.

**Relay Address** Shows the IPv6 address of the relay server.

**Relay Interface Number** Shows the relay server interface in *<slot/port>* format.

**Relay Remote ID** If configured, shows the name of the relay remote.

**Option Flags** Shows whether rapid commit is configured.

### 9.6.1.4 show ipv6 dhcp pool

This command displays configured DHCPv6 pool.

**Syntax**

```
show ipv6 dhcp pool <pool-name>
```

**<pool-name>** - a Pool Name up to 32 alphanumeric characters.

**Default Setting**

None

**Command Mode**

Privileged Exec

**Display Message****DHCP Pool Name** Unique pool name configuration.**Client DUID** Client's DHCP unique identifier. DUID is generated using the combination of the local system burned-in MAC address and a timestamp value.**Host Name** Name of the client.**Prefix/Prefix Length** IPv6 address and mask length for delegated prefix.**Preferred Lifetime** Preferred lifetime in seconds for delegated prefix.**Valid Lifetime** Valid lifetime in seconds for delegated prefix.**DNS Server Address** Address of DNS server address.**Domain Name** DNS domain name.**9.6.1.5 show ipv6 dhcp binding**

This command displays configured DHCP pool binding configurations.

**Syntax**

```
show ipv6 dhcp binding [<ipv6-address>]
```

**<ipv6-address>** - a IPv6 address.**Default Setting**

None

**Command Mode**

Privileged Exec

**Display Message****DHCP Client Address** Address of DHCP Client**DUID** String that represents the Client DUID.**IAID** Identity Association ID**Prefix/Prefix Length** IPv6 address and mask length for delegated prefix.**Prefix Type** IPV6 Prefix type (IAPD, IANA, or IATA).

**Client Address** Address of DHCP Client.

**Client Interface** IPv6 Address of DHCP Client.

**Expiration** Address of DNS server address.

**Valid Lifetime** Valid lifetime in seconds for delegated prefix.

**Preferred Lifetime** Preferred lifetime in seconds for delegated prefix.

## 9.6.2 Configuration Commands

### 9.6.2.1 service dhcpv6

This command enables/disables DHCPv6 configuration on the router.

<b>Syntax</b>
---------------

<pre>service dhcpv6 no service dhcpv6</pre>
---

#### Default Setting

Disable

#### Command Mode

Global Config

### 9.6.2.2 ipv6 dhcp server

Use this command to configure DHCPv6 server functionality on an interface. The <poolname> is the DHCPv6 pool containing stateless and/or prefix delegation parameters, rapidcommit is an option that allows for an abbreviated exchange between the client and server, and <pref-value> is a value used by clients to determine preference between multiple DHCPv6.

<b>Syntax</b>
---------------

<pre>ipv6 dhcp server &lt;pool-name&gt; [rapid-commit] [preference &lt;prefvalue&gt;] no ipv6 dhcp server</pre>
---

**no** - This command removes DHCPv6 server functionality on an interface.

**Default Setting**

None

**Command Mode**

Interface Config

### 9.6.2.3 ipv6 dhcp relay destination

Use this command to configure an interface for DHCPv6 relay functionality. Use the *destination* keyword to set the relay server IPv6 address. The *<relay-address>* parameter is an IPv6 address of a DHCPv6 relay server. Use the *interface* keyword to set the relay server interface. The *<relay-interface>* parameter is an interface (slot/port) to reach a relay server. The optional *remote-id* is the Relay Agent Information Option “remote ID” suboption to be added to relayed messages. This can either be the special keyword *duid-ifid*, which causes the “remote ID” to be derived from the DHCPv6 server DUID and the relay interface number, or it can be specified as a user-defined string.

**Note:** If *<relay-address>* is an IPv6 global address, then *<relay-interface>* is not required. If *<relay-address>* is a link-local or multicast address, then *<relay-interface>* is required. Finally, if you do not specify a value for *<relay-address>*, then you must specify a value for *<relay-interface>* and the HCPV6-ALL-AGENTS multicast address (i.e. FF02::1:2) is used to relay DHCPv6 messages to the relay server.

**Syntax**

```
ipv6 dhcp relay {destination [<relay-address>] interface [<relay-interface>]}| interface  
[<relay-interface>]} [remote-id (duid-ifid | <user-defined-string>)]  
no ipv6 dhcp relay
```

**no** - This command removes DHCPv6 relay functionality on an interface.

**Default Setting**

None

**Command Mode**

Interface Config

### 9.6.2.4 ipv6 dhcp relay-agent-info-opt

Use this command to configure a number to represent the DHCPv6 Relay Agent Information Option. The DHCPv6 Relay Agent Information Option allows for various sub-options to be attached to messages that are being relayed by the local router to a relay server. The relay server may in turn use this information in determining an address to assign to a DHCPv6 client.

**Syntax**

```
ipv6 dhcp relay-agent-info-opt <32-65535>  
no ipv6 dhcp relay-agent-info-opt
```

**no** - This command return the vaule to default.

**Default Setting**

32

**Command Mode**

Global Config

**9.6.2.5 ipv6 dhcp relay-agent-info-remote-id-subopt**

Use this command to configure a number to represent the DHCPv6 the “remote-id” suboption.

**Syntax**

```
ipv6 dhcp relay-agent-info-remote-id-subopt <1-65535>  
no ipv6 dhcp relay-agent-info-remote-id-subopt
```

**no** - This command return the vaule to default.

**Default Setting**

1

**Command Mode**

Global Config

**9.6.2.6 ipv6 dhcp pool**

Use this command from Global Config mode to enter IPv6 DHCP Pool Config mode. Use the **exit** command to return to Global Config mode. To return to the User EXEC mode, enter CTRL+Z. The *<pool-name>* should be less than 31 alpha-numeric characters. DHCPv6 pools are used to specify information for DHCPv6 server to distribute to DHCPv6 clients. These pools are shared between multiple interfaces over which DHCPv6 server capabilities are configured.

**Syntax**

```
ipv6 dhcp pool <pool-name>  
no ipv6 dhcp pool <pool-name>
```

**Default Setting**

None

**Command Mode**

Global Config

**9.6.2.7 domain-name(IPV6)**

This command sets the DNS domain name which is provided to DHCPv6 client by DHCPv6 server. DNS domain name is configured for stateless server support. Domain name consist of no more than 31 alpha-numeric characters. DHCPv6 pool can have multiple number of domain names with maximum of 8.

**Syntax**

```
domain-name <dns-domain-name>  
no domain-name
```

**Default Setting**

None

**Command Mode**

IPv6 DHCP Pool Config Mode

**9.6.2.8 dns-server(IPV6)**

This command sets the ipv6 DNS server address which is provided to dhcpv6 client by dhcpv6 server. DNS server address is configured for stateless server support. DHCPv6 pool can have multiple number of domain names with maximum of 8.

**Syntax**

```
dns-server <dns-server-address >  
no dns-server
```

**Default Setting**

None

**Command Mode**

IPv6 DHCP Pool Config Mode

**9.6.2.9 prefix-delegation (IPV6)**

Multiple IPv6 prefixes can be defined within a pool for distributing to specific DHCPv6 Prefix delegation clients. Prefix is the delegated IPv6 prefix. DUID is the client's unique DUID value (Example: 00:01:00:09:f8:79:4e:00:04:76:73:43:76'). Name is 31 characters textual client's name which is useful for logging or tracing only. Valid lifetime is the valid lifetime for the delegated prefix in seconds and preferred lifetime is the preferred lifetime for the delegated prefix in seconds.

**Syntax**

```
prefix-delegation <prefix/prefixlength> <DUID> [name <hostname>] [valid-lifetime  
<0-4294967295>][preferred-lifetime < 0-4294967295>]  
no prefix-delegation <prefix/prefix-delegation> <DUID>
```

**Default Setting**

Valid-lifetime 2592000

Preferred-lifetime 604800

**Command Mode**

IPv6 DHCP Pool Config Mode

**10 Network Cluster Management Commands**



The switch cluster network management implements a direct management of the target switches (member switches) through an intermediate switch(commander switch). A commander switch can manage multiple member switches. The switch cluster network management can dynamically discover cluster feature enabled switches (candidate switches). Network administrators can statically or dynamically add the candidate switches to the cluster which is already established. Accordingly, they can configure, manage and monitor the member switches through the commander switch. Cluster members can belong to only one cluster at a time.

When the member switches are distributed in various physical locations (such as on the different floors of the same building), cluster network management has obvious advantages. The benefits of clustering switches include:

- Management of switches regardless of their interconnection media and their physical locations. The switches can be in the same location, or they can be distributed across a Layer 2 or Layer 3 network. Indifference to network topology and distance limitation. Cluster members are connected to the cluster command switch.
- Command-switch redundancy if a cluster command switch fails. One or more switches can be designated as standby cluster command switches to avoid loss of contact with cluster members. A cluster standby group is a group of standby cluster command switches.
- Management of switches through a single IP address. This conserves on IP addresses, especially if you have a limited number of them. All communication with the switch cluster is through the cluster command switch IP address.
- Simplify configuration tasks.
- The commander switch can upgrade and configure any member switches in the cluster

## 10.1 Cluster Commands

### 10.1.1 Show Commands

#### 10.1.1.1 show cluster

This command displays the current configuration settings for the switch cluster network management.

<b>Syntax</b>
---------------

<b>show cluster</b>
---------------------

#### Default Setting

None

#### Command Mode

Privileged Exec

User Exec

### Display Message

**Switch for cluster name:** the name for switch cluster network management.

**Total number of members:** The total number switch of switch cluster network management.

**Status:** The status of active or inactive.

**Heartbeat interval:** Configure switch cluster network management heartbeat interval.

**Heartbeat hold-time:** Configure holdtime of switch cluster network management heartbeat.

#### 10.1.1.2 show cluster members

This command displays current member(s) of switch cluster network management.

<b>Syntax</b>
---------------

<b>show cluster members</b>
-----------------------------

### Default Setting

None

### Command Mode

Privileged Exec

User Exec

### Display Message

**SN:** Serial number.

**MAC Address:** The MAC address of switch.

**Name:** The switch name.

**Device Type:** The switch type.

**Status:** The switch status.

#### 10.1.1.3 show cluster candidates

This command displays current candidate(s) of switch cluster network management.

<b>Syntax</b>
---------------

<b>show cluster candidates</b>
--------------------------------

### Default Setting

None

**Command Mode**

Privileged Exec  
User Exec

**Display Message**

**SN:** Serial number.  
**MAC Address:** The MAC address of switch.  
**IP Address:** The IP address of switch  
**Name:** The switch name.  
**Device Type:** The switch type

### 10.1.2 Configuration Commands

#### 10.1.2.1 cluster

This command will enable the switch cluster network management.

**Syntax**

```
cluster  
no cluster
```

**No** - This command will disable the switch cluster network management.

**Default Setting**

disable

**Command Mode**

Global Config

#### 10.1.2.2 cluster register timer

This command will set interval of sending cluster packet for switch cluster network management.

**Syntax**

```
cluster register timer <time-value>  
no cluster register timer
```

**No** - This command will restore the default setting.

**Default Setting**

The default value is 60 (seconds)

**Command Mode**

Global Config

**10.1.2.3 cluster commander**

This command will create a commander switch of the switch cluster network management.

**Syntax**

```
cluster commander <cluster-name>  
no cluster commander
```

**<cluster-name>** - The name of the switch cluster.

**no** - This command will remove a commander switch from the switch cluster network management.

**Default Setting**

none

**Command Mode**

Global Config

**10.1.2.4 cluster member**

This command will add a candidate switch to the switch cluster network management in the commander switch.

**Syntax**

```
cluster member {candidate-sn <cand-sn> | mac-address <mac-add> [<mem-id>]}  
no cluster member <mem-id >
```

**<cand-sn>** - The candidate serial number.

**<mac-add>** - the switch mac address.

**<mem-id>** - specify the member id of the switch cluster network management.

**no** - This command will remove a commander switch from the switch cluster network management.

**Default Setting**

none

**Command Mode**

Global Config

**10.1.2.5 cluster auto-add enable**

This command will discover new candidate switches and add the member switch to cluster automatically.

**Syntax**

```
cluster auto-add enable
no cluster auto-add enable
```

**no** - This command will disable this function.

**Default Setting**

This function is disabled by default. That means that the candidate switches are not automatically added to the cluster.

**Command Mode**

Global Config

**10.1.2.6 clear cluster candidate-table**

This command will clear list of the candidate switches that discovered by the commander switch.

**Syntax**

```
clear cluster candidate-table
```

**Default Setting**

None

**Command Mode**

Privileged Exec

### 10.1.2.7 cluster holdtime

This command will set holdtime of heartbeat of the cluster.

**Syntax**

```
cluster holdtime < second>
```

**<second>** - a unit issecond.

**no** - Resets to default value.

**Default Setting**

The default value is 80

**Command Mode**

Global Config

### 10.1.2.8 cluster heartbeat

This command will set interval of sending heartbeat packets among the switches of the cluster.

**Syntax**

```
cluster heartbeat <interval>
```

```
no cluster heartbeat
```

**<interval>** - a unit issecond.

**no** - This command will reset interval of sending heartbeat packets among the switches of the cluster.

**Default Setting**

The default value is 8

**Command Mode**

Global Config

### 10.1.2.9 cluster rcommand member

This command is used to remotely manage the member switches in the cluster

**Syntax**

```
cluster rcommand member <mem-id>
```

<mem-id> - The cluster member id.

**Default Setting**

None

**Command Mode**

Global Config

**10.1.2.10 cluster rcommand commander**

This command is used to configure the commander switch.

**Syntax**

```
cluster rcommand commander
```

**Default Setting**

None

**Command Mode**

Global Config

**10.1.2.11 cluster reset member**

This command can be used to reset the member switch(s)

**Syntax**

```
cluster reset member <mem-id>
```

<mem-id> - The cluster member id.

**Default Setting**

None

**Command Mode**

Global Config

### 10.1.2.12 cluster update member

This command is used to remotely upgrade the member switch.

#### Syntax

```
cluster update member <mem-id> <src-url> <dst-url> [clibanner|script|image|config|  
sshkey-dsa|sshkey-rsa1|sshkey-rsa2|sslpem-dhstrong|sslpem-dhweak|sslpem-root|  
sslpem-server ]
```

**<mem-id>** - The cluster member id.

**<src-url>** - Source URL (ftp://user:password@server/remote  
filename,ftp://server/remote filename)

**<dst-url>** - Destination URL(local filename)

**clibanner** - CLI Banner file.

**script** - Configuration Script file.

**image** - Code file.

**config** - Config file.

**sshkey-dsa** - SSH DSA Key file.

**sshkey-rsa1** - SSH RSA1 Key file.

**sshkey-rsa2** - SSH RSA2 Key file.

**sslpem-dhstrong** - Secure DH Strong PEM.

**sslpem-dhweak** - Secure DH Weak PEM.

**sslpem-root** - Secure Root PEM file.

**sslpem-server** - Secure Server PEM file.

#### Default Setting

None

#### Command Mode

Global Config



## 11 Web-Based Management Interface

### 11.1 Overview

Your Layer 3 Network Switch provides a built-in browser software interface that lets you configure and manage it remotely using a standard Web browser such as Microsoft Internet Explorer or Netscape Navigator. This software interface also allows for system monitoring and management of the Network Switch. When you configure this Network Switch for the first time from the console, you have to assign an IP address and subnet mask to the Network Switch. Thereafter, you can access the Network Switch's Web software interface directly using your Web browser by entering the switch's IP address into the address bar. In this way, you can use your Web browser to manage the Switch from any remote PC station, just as if you were directly connected to the Network Switch's console port.

The 7 menu options available are: **System, Switching, Routing, Security, IPv6, QOS, and IP Multicast.**

1. **System Menu:** This section provides information for configuring switch interface (port), SNMP and trap manager, Ping, DHCP client, SNTP, system time, defining system parameters including telnet session and console baud rate, etc, downloading switch module software, and resetting the switch module, switch statistics and Layer 2 Mac address.
2. **Switching Menu:** This section provides users to configure switch Port-Based VLAN, Protocol-Based VLAN, Voice VLAN, Guest VLAN, GARP, IGMP Snooping, Port Channel, Spanning Tree, and 802.1p priority Mapping, port security, LLDP, and VTP.
3. **Routing Menu:** This section provides users to configure OSPF, RIP, Router Discovery, Static Route, VLAN Routing, VRRP, BOOTP/DHCP relay, DNS relay, Tunnels and Loopbacks.
4. **Security Menu:** This section provides users to configure switch securities including 802.1x, Radius, TACACS+, IP filter, Secure Http, and Secure Shell.
5. **IPv6 Menu:** This section provides users to configure OSPFv3, RIPng, DHCPv6, IPv6 Static Route, and IPv6 Routing Interface.
6. **QOS Menu:** This section provides users to configure Access Control Lists, Differentiated Service, and Class of Service.
7. **IP Multicast Menu:** This section provides users to configure DVMRP, IGMP Snooping, IGMP Snooping Querier, MLD Snooping, MLD Snooping Querier, Multicast, PIM-DM, PIM-SM. It also provides information for a multicast distribution tree.
8. **Cluster:** This section provides users to configure network cluster management.

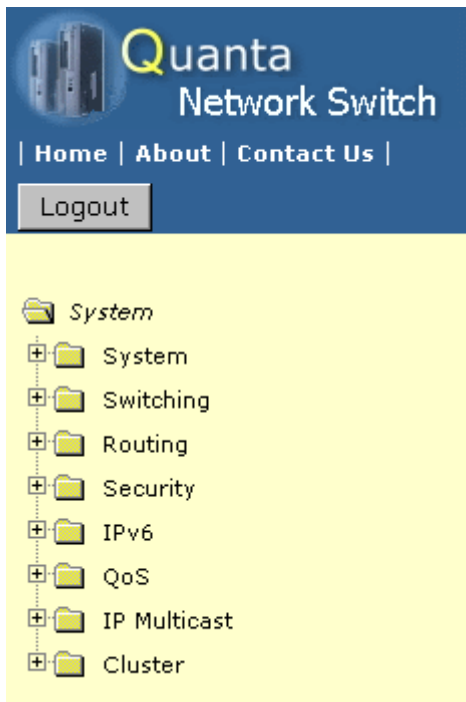

## 11.2 Main Menu

### 11.2.1 System Menu

#### 11.2.1.1 View ARP Cache

The Address Resolution Protocol (ARP) dynamically maps physical (MAC) addresses to Internet (IP) addresses. This panel displays the current contents of the ARP cache.

For each connection, the following information is displayed:

- The physical (MAC) Address
- The associated IP address
- The identification of the port being used for the connection

#### Command Buttons

**Refresh** - Refresh the page with the latest data.

**Clear all** - Clean all MAC entries in system ARP table.

ARP Cache
Print
Reload
Help

MAC Address	IP Address	Slot/Port
00:10:4B:1A:C9:62	192.168.2.100	Management

Controller time: 2008/1/14 16:23:48

### 11.2.1.2 Viewing Inventory Information

Use this panel to display the switch's Vital Product Data, stored in non-volatile memory at the factory.

#### Non-Configurable Data

**System Description** - The product name of this switch.

**Machine Type** - The machine type of this switch.

**Machine Model** - The model within the machine type.

**Serial Number** - The unique box serial number for this switch.

**Part Number** - The manufacturing part number.

**Base MAC Address** - The burned-in universally administered MAC address of this switch.

**Hardware Version** - The hardware version of this switch. It is divided into four parts. The first byte is the major version and the second byte represents the minor version.

**Loader Version** - The release-version maintenance number of the loader code currently running on the switch. For example, if the release was 1, the version was 2, and the maintenance number was 4, the format would be '1.2.4'.

**Boot Rom Version** - The release-version maintenance number of the boot rom code currently running on the switch. For example, if the release was 1, the version was 2, and the maintenance number was 4, the format would be '1.2.4'.

**Label Revision Number** - The label revision serial number of this switch is used for manufacturing purpose.

**Runtime Version** - The release-version maintenance number of the code currently running on the switch. For example, if the release was 1, the version was 2, and the maintenance number was 4, the format would be '1.2.4'.

**Operating System** - The operating system currently running on the switch.

**Network Processing Device** - Identifies the network processor hardware.

**Gigabit Ethernet Compliance Codes** - Transceiver's compliance codes.

**Vendor Name** - The SFP transceiver vendor name shall be the full name of the corporation, a commonly accepted abbreviation of the name of the corporation, the SCSI

company code for the corporation, or the stock exchange code for the corporation.

**Vendor Part Number** - Part number provided by SFP transceiver vendor.

**Vendor Serial Number** - Serial number provided by vendor.

**Vendor Revision Number** - Revision level for part number provided by vendor.

**Vendor Manufacturing Date** - Identifies the network processor hardware.

**Now Temperature** – The temperature of the switch

**FAN 1 Status** – The status of FAN 1. It is active or inactive.

**FAN 2 Status** – The status of FAN 2. It is active or inactive.

**FAN 3 Status** – The status of FAN 3. It is active or inactive.

**Additional Packages** - A list of the optional software packages installed on the switch, if any.

### Command Buttons

**Refresh** - Updates the information on the page.

<b>Inventory Information</b>		Print	Reload	Help
System Description	Quanta			
Machine Type	LB6B			
Machine Model	LB6B			
Serial Number	123456789			
Part Number	123456789			
Base MAC Address	00:C0:9F:11:22:99			
Hardware Version	0.1			
Loader Version	0.1			
Boot Rom Version	0.1			
Label Revision Number	123456789			
Runtime Version	0.01			
Operating System	VxWorks5.5.2			
Network Processing Device	BCM56800 REV 1			
Switch 1 Found Passive CX4 10G Daughter Board				
10G Module 1	CX4			
10G Module 2	CX4			
10G Module 3	CX4			
10G Module 4	CX4			
10G Module 4	SFP Plus			
10 Gigabit Ethernet Compliance Codes	Reserved			
Vendor Name	PICOLIGHT			
Vendor Part Number	PLRXPL-VC-S43-6G			
Vendor Serial Number	ES82R2RFF			
Vendor Revision Number				
Vendor Manufacturing Date	2006/11/29			
10G Module 8	SFP Plus			

10 Gigabit Ethernet Compliance Codes	Reserved
Vendor Name	PICOLIGHT
Vendor Part Number	PLRXPLVCS4321
Vendor Serial Number	C703UA011
Vendor Revision Number	1
Vendor Manufacturing Date	2007/01/31
Switch 1 Found Active CX4 10G Daughter Board	
10G Module 1	CX4
10G Module 2	CX4
10G Module 3	CX4
10G Module 4	CX4
Now Temperature	30.75
FAN 1 Status	active
FAN 2 Status	active
FAN 3 Status	active
Additional Packages	<div style="border: 1px solid gray; padding: 2px;"> FASTPATH QoS  FASTPATH Multicast  FASTPATH IPv6 </div>
<input type="button" value="Refresh"/>	

Controller time: 2008/1/8 10:34:3

### 11.2.1.3 Configuring Management Session and Network Parameters

#### 11.2.1.3.1. Viewing System Description Page

##### Configurable Data

**System Name** - Enter the name you want to use to identify this switch. You may use up to 31 alpha-numeric characters. The factory default is blank.

**System Location** - Enter the location of this switch. You may use up to 31 alpha-numeric characters. The factory default is blank.

**System Contact** - Enter the contact person for this switch. You may use up to 31 alpha-numeric characters. The factory default is blank.

##### Non-Configurable Data

**System Description** - The product name of this switch.

**System Object ID** - The base object ID for the switch's enterprise MIB.

**System IP Address** - The IP Address assigned to the network interface.

**System Up time** - The time in days, hours and minutes since the last switch reboot.

**Current SNTP Synchronized Time** - Displays currently synchronized SNTP time in UTC. If time is not synchronised, it displays "Not Synchronized."

**MIBs Supported** - The list of MIBs supported by the management agent running on this

switch.

**Command Buttons**

**Submit** - Update the switch with the values on the screen. If you want the switch to retain the new values across a power cycle you must perform a save.

System Description

 **Print**
 **Reload**
 **Help**

System Description	Quanta
System Name	<input type="text"/>
System Location	<input type="text"/>
System Contact	<input type="text"/>
IP Address	192.168.2.1
System Object ID	quanta
System Up Time	0 days, 0 hours, 46 mins
Current SNMP Synchronized Time	Not Synchronized
	RFC 1907 - SNMPv2-MIB
	RFC 2819 - RMON-MIB
	QUANTA-SWITCH-MIB
	SNMP-COMMUNITY-MIB
	SNMP-FRAMEWORK-MIB
	SNMP-MPD-MIB
	SNMP-NOTIFICATION-MIB
	SNMP-TARGET-MIB
	SNMP-USER-BASED-SM-MIB
	SNMP-VIEW-BASED-ACM-MIB
	USM-TARGET-TAG-MIB
	LAG-MIB
	RFC 1213 - RFC1213-MIB
	RFC 1493 - BRIDGE-MIB
	RFC 2674 - P-BRIDGE-MIB
	RFC 2674 - Q-BRIDGE-MIB
	RFC 2737 - ENTITY-MIB
	RFC 2863 - IF-MIB
	RFC 3635 - Etherlike-MIB
	SWITCHING-MIB
	SWITCHING-EXTENSION-MIB
	INVENTORY-MIB
	PORTSECURITY-PRIVATE-MIB
	IEEE8021-PAE-MIB

MIBs Supported	TACACS-MIB RADIUS-CLIENT-PRIVATE-MIB RADIUS-ACC-CLIENT-MIB RADIUS-AUTH-CLIENT-MIB MGMT-SECURITY-MIB IANA-ADDRESS-FAMILY-NUMBERS-MIB RFC 1724 - RIPv2-MIB RFC 1850 - OSPF-MIB RFC 1850 - OSPF-TRAP-MIB RFC 2787 - VRRP-MIB ROUTING-MIB QOS-MIB QOS-ACL-MIB QOS-COS-MIB RFC 3289 - DIFFSERV-DSCP-TC RFC 3289 - DIFFSERV-MIB QOS-DIFFSERV-EXTENSIONS-MIB QOS-DIFFSERV-PRIVATE-MIB RFC 2932 - IPROUTE-MIB draft-ietf-magma-mgmd-mib-03 RFC 2934 - PIM-MIB DVMRP-STD-MIB IANA-RTPROTO-MIB MULTICAST-MIB RFC 2465 - IPV6-MIB RFC 2466 - IPV6-ICMP-MIB RFC 3419 - TRANSPORT-ADDRESS-MIB FASTPATH-ROUTING6-MIB
<input type="button" value="Submit"/>	
Controller time: 2008/1/8 10:36:51	

### 11.2.1.3.2. Configuring Service Port Page

You use this panel to specify the parameters needed to communicate with the switch over a network using the service port.

#### Configurable Data

**IP Address** - The IP address of the interface. The factory default value is 0.0.0.0

**Subnet Mask** - The IP subnet mask for the interface. The factory default value is 0.0.0.0

**Default Gateway** - The default gateway for the IP interface. The factory default value is 0.0.0.0

**ServPort Configuration Protocol Current** - Indicates the network protocol used on the last, or current power-up cycle, if any.

You cannot make this choice for both the network configuration protocol and the service port. You will only be given the choices for Bootp or DHCP here if the network configuration protocol is configured to None.



#### Non-Configurable Data

**Burned-in MAC Address** - The burned-in MAC address used for in-band connectivity.

## Command Buttons

**Submit** - Update the switch with the values on the screen. If you want the switch to retain the new values across a power cycle you must perform a save.

Service Port Configuration

 **Print**
 **Reload**
 **Help**

**Service Port1**

IP Address	<input type="text" value="0.0.0.0"/>
Subnet Mask	<input type="text" value="0.0.0.0"/>
Default Gateway	<input type="text" value="0.0.0.0"/>
Service Port Configuration Protocol Current	<input type="text" value="DHCP"/>
Burned In MAC Address	00:C0:9F:82:29:0D

**Service Port2**

IP Address	<input type="text" value="0.0.0.0"/>
Subnet Mask	<input type="text" value="0.0.0.0"/>
Default Gateway	<input type="text" value="0.0.0.0"/>
Service Port 2 Configuration Protocol Current	<input type="text" value="None"/>
Burned In MAC Address	00:C0:9F:82:29:0F

### 11.2.1.3.3. Configuring Network Connectivity Page

The network interface is the logical interface used for in-band connectivity with the switch via any of the switch's front panel ports. The configuration parameters associated with the switch's network interface do not affect the configuration of the front panel ports through which traffic is switched or routed.

To access the switch over a network you must first configure it with IP information (IP address, subnet mask, and default gateway). You can configure the IP information using any of the following:

#### **BOOTP**

#### **DHCP**

#### **Terminal interface via the EIA-232 port**

Once you have established in-band connectivity, you can change the IP information using any of the following:

#### **Terminal interface via the EIA-232 port**

#### **Terminal interface via telnet**

#### **SNMP-based management**

#### **Web-based management**

## Configurable Data



**IP Address** - The IP address of the interface. The factory default value is 0.0.0.0

**Subnet Mask** - The IP subnet mask for the interface. The factory default value is 0.0.0.0

**Default Gateway** - The default gateway for the IP interface. The factory default value is 0.0.0.0

**Network Configuration Protocol Current** - Specify what the switch should do following power-up: transmit a Bootp request, transmit a DHCP request, or do nothing (None). The factory default is None.

You cannot make this choice for both the network configuration protocol and the service port. You will only be given the choices for Bootp or DHCP here if the service port protocol is configured to None.

**Management VLAN ID** - Specifies the management VLAN ID of the switch. It may be configured to any value in the range of 1 - 3965. The management VLAN is used for management of the switch. This field is configurable for administrative users and read-only for other users.

**Web Mode** - Specify whether the switch may be accessed from a Web browser. If you choose to enable web mode you will be able to manage the switch from a Web browser. The factory default is enabled.

**Java Mode** - Enable or disable the java applet that displays a picture of the switch at the top right of the screen. If you run the applet you will be able to click on the picture of the switch to select configuration screens instead of using the navigation tree at the left side of the screen. The factory default is enabled.

**Web Port** - This field is used to set the HTTP Port Number. The value must be in the range of 1 to 65535. Port 80 is the default value. The currently configured value is shown when the web page is displayed.

#### **Non-Configurable Data**

**Burned-in MAC Address** - The burned-in MAC address used for in-band connectivity if you choose not to configure a locally administered address.

#### **Command Buttons**

**Submit** - Update the switch with the values on the screen. If you want the switch to retain the new values across a power cycle you must perform a save.

**Network Connectivity Configuration** Print Reload Help

IP Address	<input type="text" value="0.0.0.0"/>
Subnet Mask	<input type="text" value="0.0.0.0"/>
Default Gateway	<input type="text" value="0.0.0.0"/>
Burned In MAC Address	00:C0:9F:00:28:BB
Network Configuration Protocol Current	None
Management VLAN ID	<input type="text" value="1"/>
Web Mode	Enable
Java Mode	Enable
Web Port	<input type="text" value="80"/>

Controller time: 2008/1/14 16:54:45

#### 11.2.1.3.4. Configuring Network Connection NDP Summary Page

This screen displays IPv6 Network Port Neighbor entries.

#### Non-Configurable Data

**IPv6 Address** - The Ipv6 Address of a neighbor switch visible to the Network Port.

**Mac Address** - The Mac Address of the neighboring switch.

**isRtr** - true(1) if the neighbor machine is a router, false(2) otherwise.

**Neighbor State** - The state of the neighboring switch:

reachable(1) - The neighbor is reachable by this switch.

stale(2) - Information about the neighbor is scheduled for deletion.

delay(3) - No information has been received from neighbor during delay period.

robe(4) - Switch is attempting to probe for this neighbor.

unknown(6) - Unknown status.

**Last Updated** - The last sysUpTime that this neighbor has been updated.

#### Command Buttons

**Refresh** - Refresh the data on the screen with the present state of the data in the router.

**Network NDP Summary** Print Reload Help

IPv6 Address	Mac Address	isRtr	Neighbor State	Last Updated
FE80::21F:C6FF:FE14:5723	00:1F:C6:14:57:23	False	Reachable	10470

### 11.2.1.3.5. HTTP Configuration

#### Configurable Data

**HTTP Session Soft Timeout** - This field is used to set the inactivity timeout for HTTP sessions. The value must be in the range of (0 to 60) minutes. A value of zero corresponds to an infinite timeout. The default value is 5 minutes. The currently configured value is shown when the web page is displayed.

**HTTP Session Hard Timeout** - This field is used to set the hard timeout for HTTP sessions. This timeout is unaffected by the activity level of the session. The value must be in the range of (0 to 168) hours. A value of zero corresponds to an infinite timeout. The default value is 24 hours. The currently configured value is shown when the web page is displayed.

**Maximum Number of HTTP Sessions** - This field is used to set the maximum allowable number of HTTP sessions. The value must be in the range of (0 to 16). The default value is 16. The currently configured value is shown when the web page is displayed.

#### Command Buttons

**Submit** - Send the updated screen to the switch. Changes take effect on the switch but these changes will not be retained across a power cycle unless a save is performed.

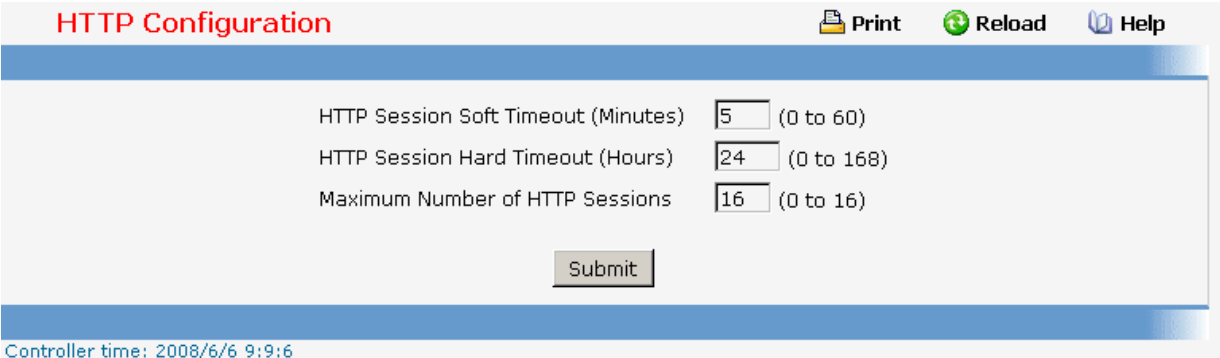

**HTTP Configuration** Print Reload Help

HTTP Session Soft Timeout (Minutes)  (0 to 60)

HTTP Session Hard Timeout (Hours)  (0 to 168)

Maximum Number of HTTP Sessions  (0 to 16)

Controller time: 2008/6/6 9:9:6

### 11.2.1.3.6. Configuring Telnet Session Page

#### Configurable Data

**Telnet Session Timeout (minutes)** - Specify how many minutes of inactivity should occur on a telnet session before the session is logged off. You may enter any number from 1 to 160. The factory default is 5.

**Maximum Number of Telnet Sessions** - Use the pulldown menu to select how many simultaneous telnet sessions will be allowed. The maximum is 5, which is also the factory default.

**Allow New Telnet Sessions** - If you set this to no, new telnet sessions will not be allowed. The factory default is yes.

**Telnet Server Admin Mode** - Administrative mode for inbound telnet sessions. Setting this value to disable shuts down the telnet port. If the admin mode is set to disable, then all existing telnet connections are disconnected. The default value is Enable.

**Password Threshold** - When the logon attempt threshold is reached on the console port, the system interface becomes silent for a specified amount of time before allowing the next logon attempt. (Use the silent time command to set this interval.) When this threshold is reached for Telnet, the Telnet logon interface closes. The default value is 3.

### Command Buttons

**Submit** - Update the switch with the values on the screen. If you want the switch to retain the new values across a power cycle you must perform a save.

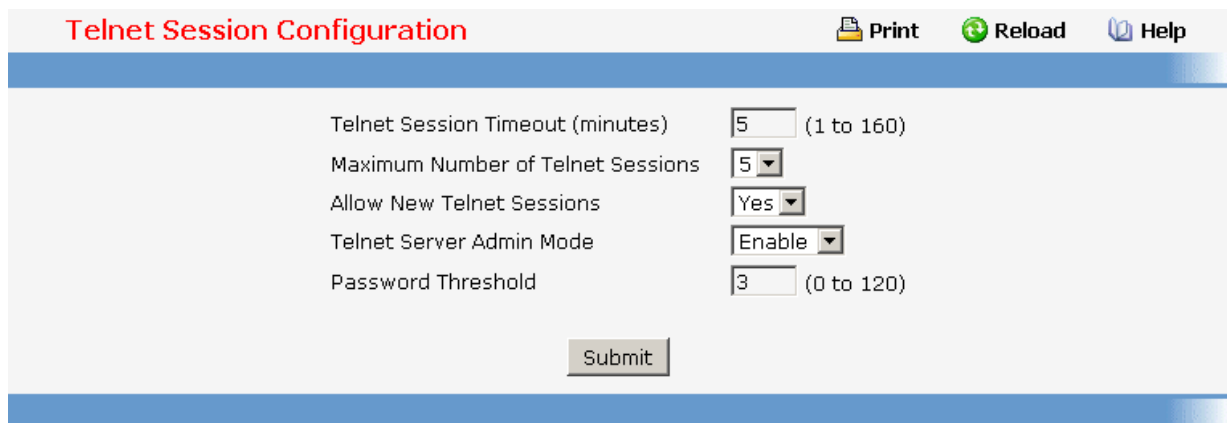

### 11.2.1.3.7. Configuring Outbound Telnet Client Configuration Page

#### Configurable Data

**Admin Mode** - Specifies if the Outbound Telnet service is Enabled or Disabled. Default value is Enabled.



**Maximum Sessions** - Specifies the maximum number of Outbound Telnet Sessions allowed. Default value is 5. Valid Range is (0 to 5).

**Session Timeout** - Specifies the Outbound Telnet login inactivity timeout. Default value is 5. Valid Range is (1 to 160).

#### Command Buttons

**Submit** - Sends the updated configuration to the switch. Configuration changes take effect immediately.

Outbound Telnet Client Configuration

 Print
  Reload
  Help

Admin Mode

Maximum Sessions  (0 to 5)

Session Timeout(minutes)  (1 to 160)

### 11.2.1.3.8. Configuring Serial Port Page

#### Configurable Data

**Serial Port Login Timeout (minutes)** - Specify how many minutes of inactivity should occur on a serial port connection before the switch closes the connection. Enter a number between 0 and 160: the factory default is 5. ***Entering 0 disables the timeout.***

**Baud Rate (bps)** - Select the default baud rate for the serial port connection from the pull-down menu. You may choose from 1200, 2400, 4800, 9600, 19200, 38400, 57600, and 115200 baud. The factory default is 9600 baud.

**Password Threshold** - When the logon attempt threshold is reached on the console port, the system interface becomes silent for a specified amount of time before allowing the next logon attempt. (Use the silent time command to set this interval.) When this threshold is reached for Telnet, the Telnet logon interface closes. The default value is 3.

**Silent Time (Sec)** - Use this command to set the amount of time the management console is inaccessible after the number of unsuccessful logon attempts exceeds the threshold set by the password threshold command. The default value is 0.

#### Non-Configurable Data

**Character Size (bits)** - The number of bits in a character. This is always 8.

**Flow Control** - Whether hardware flow control is enabled or disabled. It is always disabled.



**Stop Bits** - The number of stop bits per character. It is always 1.

**Parity** - The parity method used on the serial port. It is always None.

#### Command Buttons

**Submit** - Update the switch with the values on the screen. If you want the switch to retain the new values across a power cycle you must perform a save.

Serial Port Configuration

 Print
  Reload
  Help

---

Serial Port Login Timeout (minutes)	<input type="text" value="160"/> (0 to 160)
Baud Rate (bps)	<input type="text" value="115200"/>
Character Size (bits)	8
Flow Control	Disabled
Stop Bits	1
Parity	None
Password Threshold	<input type="text" value="3"/> (0 to 120)
Silent Time (Sec)	<input type="text" value="0"/> (0 to 65535)

### 11.2.1.3.9. Defining User Accounts Page

By default, two user accounts exist:

admin, with 'Read/Write' privileges

guest, with 'Read Only' privileges

By default, both of these accounts have blank passwords. The names are not case sensitive.

If you logon with a user account with 'Read/Write' privileges (that is, as admin) you can use the User Accounts screen to assign passwords and set security parameters for the default accounts, and to add and delete accounts (other than admin) up to the maximum of six. Only a user with 'Read/Write' privileges may alter data on this screen, and only one account may be created with 'Read/Write' privileges.

#### Selection Criteria

**User Name Selector** - You can use this screen to reconfigure an existing account, or to create a new one. Use this pulldown menu to select one of the existing accounts, or select 'Create' to add a new one, provided the maximum of five 'Read Only' accounts has not been reached.

#### Configurable Data

**User Name** - Enter the name you want to give to the new account. (You can only enter data in this field when you are creating a new account.) User names are up to eight characters in length and are not case sensitive. Valid characters include all the alphanumeric characters as well as the dash ('-') and underscore ('\_') characters.

**Password** - Enter the optional new or changed password for the account. It will not display as it is typed, only asterisks (\*) will show. Passwords are up to eight alpha numeric characters in length, and are case sensitive.

**Confirm Password** - Enter the password again, to confirm that you entered it correctly. This field will not display, but will show asterisks (\*).

**Authentication Protocol** - Specify the SNMPv3 Authentication Protocol setting for the selected user account. The valid Authentication Protocols are None, MD5 or SHA. If you select None, the user will be unable to access the SNMP data from an SNMP browser. If

you select MD5 or SHA, the user login password will be used as the SNMPv3 authentication password, and you must therefore specify a password, and it must be eight characters.

**Encryption Protocol** - Specify the SNMPv3 Encryption Protocol setting for the selected user account. The valid Encryption Protocols are None or DES. If you select the DES Protocol you must enter a key in the Encryption Key field. If None is specified for the Protocol, the Encryption Key is ignored.

**Encryption Key** - If you selected DES in the Encryption Protocol field enter the SNMPv3 Encryption Key here. Otherwise this field is ignored. Valid keys are 8 to 64 characters. The Apply checkbox must be checked in order to change the Encryption Protocol and Encryption Key.

### Non-Configurable Data

**Access Mode** - Indicates the user's access mode. The admin account always has 'Read/Write' access, and all other accounts have 'Read Only' access.

**SNMP v3 Access Mode** - Indicates the SNMPv3 access privileges for the user account. The admin account always has 'Read/Write' access, and all other accounts have 'Read Only' access.

**Lockout Status** - Indicates whether the user account is locked due to excessive failed login attempts. The threshold for number of attempts before lockout is specified by 'lockout attempts' on the password management page.



**Password Expiration Date** - Displays the date after which the user will be required to change passwords if password aging is enabled.

### Command Buttons

**Submit** - Update the switch with the values on this screen. If you want the switch to retain the new values across a power cycle, you must perform a save.

**Delete** - Delete the currently selected user account. If you want the switch to retain the new values across a power cycle, you must perform a save. This button is only visible when you have selected a user account with 'Read Only' access. You cannot delete the 'Read/Write' user.

User Accounts

 Print
  Reload
  Help

---

User	admin	
User Name	admin	
Password	<input type="password"/>	(8 to 64 Alphanumeric Characters)
Confirm Password	<input type="password"/>	(8 to 64 Alphanumeric Characters)
Access Mode	Read/Write	
Lockout Status	False	
Password Expiration Date	----	

**SNMP v3 User Configuration**

SNMP v3 Access Mode	Read/Write	
Authentication Protocol	None	
Encryption Protocol	None	
Encryption Key	<input type="text"/>	<input type="checkbox"/> Apply

### 11.2.1.3.10. Defining Authentication List Configuration Page

You use this screen to configure login lists. A login list specifies the authentication method(s) you want used to validate switch or port access for the users associated with the list. The pre-configured users, admin and guest, are assigned to a pre-configured list named defaultList, which you may not delete. All newly created users are also assigned to the defaultList until you specifically assign them to a different list

#### Selection Criteria

**Authentication List** - Select the authentication login list you want to configure. Select 'create' to define a new login list. When you create a new login list, 'local' is set as the initial authentication method.

#### Configurable Data

**Authentication List Name** - If you are creating a new login list, enter the name you want to assign. It can be up to 15 alphanumeric characters and is not case sensitive.

**Method 1** - Use the dropdown menu to select the method that should appear first in the selected authentication login list. If you select a method that does not time out as the first method, such as 'local' no other method will be tried, even if you have specified more than one method. Note that this parameter will not appear when you first create a new login list. The options are:

**Local**- the user's locally stored ID and password will be used for authentication

**Radius**- the user's ID and password will be authenticated using the RADIUS server instead of locally

**Tacacs**- the user's ID and password will be authenticated using the TACACS server instead of locally

**Reject**- the user is never authenticated

**Undefined**- the authentication method is unspecified (this may not be assigned as the first method)



**Method 2** - Use the dropdown menu to select the method, if any, that should appear second in the selected authentication login list. This is the method that will be used if the first method times out. If you select a method that does not time out as the second method, the third method will not be tried. Note that this parameter will not appear when you first create a new login list.

**Method 3** - Use the dropdown menu to select the method, if any, that should appear third in the selected authentication login list. Note that this parameter will not appear when you first create a new login list.

### Command Buttons

**Submit** - Sends the updated screen to the switch and causes the changes to take effect on the switch. These changes will not be retained across a power cycle unless you perform a save.

**Delete** - Remove the selected authentication login list from the configuration. The delete will fail if the selected login list is assigned to any user (including the default user) for system login or IEEE 802.1x port access control. You can only use this button if you have Read/Write access. The change will not be retained across a power cycle unless you perform a save.

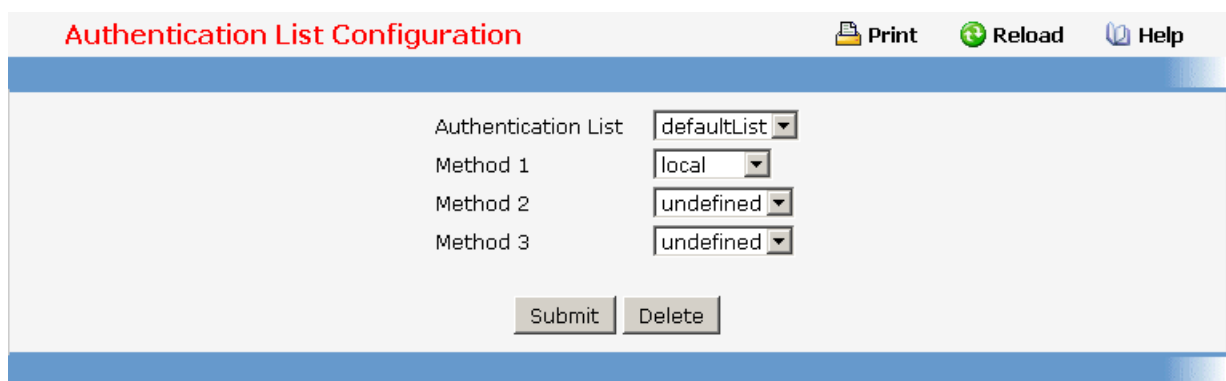

### 11.2.1.3.11. Viewing Login Session Page

#### Non-Configurable Data

**ID** - Identifies the ID of this row.

**User Name** - Shows the user name of user who made the session.

**Connection From** - Shows the IP from which machine the user is connected.

**Idle Time** - Shows the idle session time.

**Session Time** - Shows the total session time.

**Session Type** – Shows the type of session: telnet, serial or SSH.

### Command Buttons

**Refresh** - Update the information on the page.

Login Sessions					
ID	User Name	Connection From	Idle Time	Session Time	Session Type
00	admin	EIA-232	00:31:09	00:32:33	Serial Port
Refresh					

### 11.2.1.3.12. Viewing Authentication List Summary Page

#### Non-Configurable Data

**Authentication List** - Identifies the authentication login list summarized in this row.

**Method List** - The ordered list of methods configured for this login list.

**Login Users** - The users you assigned to this login list on the User Login Configuration screen. This list is used to authenticate the users for system login access.

**802.1x Port Security Users** The users you assigned to this login list on the Port Access Control User Login Configuration screen - This list is used to authenticate the users for port access, using the IEEE 802.1x protocol.

#### Command Buttons

**Refresh** - Update the information on the page.

Authentication List Summary			
Authentication List	Method List	Login Users	802.1x Port Security Users
defaultList	local	admin guest default	admin guest default
Refresh			

### 11.2.1.3.13. Defining User Login Page

**Note:** This page provides a user account (from those already created) to be added into the Authentication List.

Each configured user is assigned to a login list that specifies how the user should be authenticated when attempting to access the switch or a port on the switch. After creating a new user account on the User Account screen, you should assign that user to a login list for the switch using this screen and, if necessary, to a login list for the ports using the Port Access Control User Login Configuration screen. If you need to create a new login list for the user, you would do so on the Login Configuration screen.

The pre-configured users, admin and guest, are assigned to a pre-configured list named defaultList, which you may not delete. All newly created users are also assigned to the defaultList until you specifically assign them to a different list.

A user that does not have an account configured on the switch is termed the 'default' or 'non-configured' user. If you assign the 'non-configured user' to a login list that specifies authentication via the RADIUS server, you will not need to create an account for all users on each switch. However, by default the 'non-configured user' is assigned to 'defaultList', which by default uses local authentication.

### Selection Criteria

**User** - Select the user you want to assign to a login list. Note that you must always associate the admin user with the default list. This forces the admin user to always be authenticated locally to prevent full lockout from switch configuration. If you assign a user to a login list that requires remote authentication, the user's access to the switch from all CLI, web, and telnet sessions will be blocked until the authentication is complete. Refer to the discussion of maximum delay in the RADIUS configuration help.

### Configurable Data

**Authentication List** - Select the authentication login list you want to assign to the user for system login.

### Command Buttons

**Submit** - Sends the updated screen to the switch and causes the changes to take effect on the switch. These changes will not be retained across a power cycle unless you perform a save.

**Refresh** - Updates the information on the page.

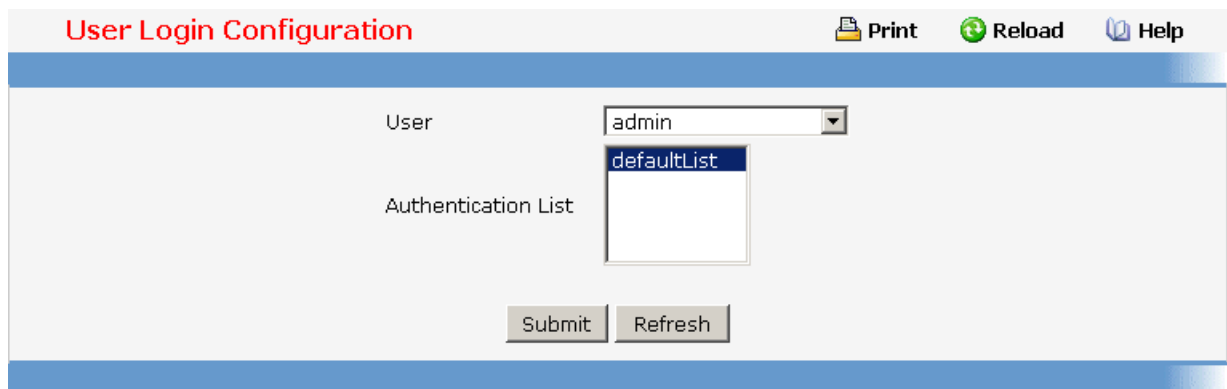

## 11.2.1.3.14. Defining Password Management

### Configurable Data

**Password Minimum Length** - All new local user passwords must be at least this many characters in length.

**Password Aging (days)** - The maximum time that user passwords are valid, in days, from the time the password is set. Once a password expires, the user will be required to enter a new password following the first login after password expiration. A value of 0 indicates that passwords never expire.



**Password History** - The number of previous passwords to store for prevention of password reuse. This ensures that each user does not reuse passwords often. A value of 0 indicates that no previous passwords will be stored.

**Lockout Attempts** - The number of allowable failed local authentication attempts before the user's account is locked. A value of 0 indicates that user accounts will never be locked.

### Command Buttons

**Submit** - Send the updated screen to the switch and cause the changes to take effect on the switch. These changes will not be retained across a power cycle unless you perform a save.

Password management

 Print
  Reload
  Help

---

Password Minimum Length	<input style="width: 50px;" type="text" value="8"/>	(8 to 64)
Password Aging (days)	<input style="width: 50px;" type="text" value="0"/>	(1 to 365)
Password History	<input style="width: 50px;" type="text" value="0"/>	(0 to 10)
Lockout Attempts	<input style="width: 50px;" type="text" value="0"/>	(1 to 5)

Controller time: 2008/6/6 9:18:4

### 11.2.1.3.15. Defining Denial Of Service Page

#### Configurable Data

**Denial of Service SIP=DIP** - Enable or disable this option by selecting the corresponding line on the pulldown entry field. Enabling SIP=DIP DoS prevention causes the switch to drop packets that have a source IP address equal to the destination IP address. The factory default is disabled.

**Denial of Service First Fragment** - Enable or disable this option by selecting the corresponding line on the pulldown entry field. Enabling First Fragment DoS prevention causes the switch to drop packets that have a TCP header smaller than the configured Min TCP Hdr Size. The factory default is disabled.

**Denial of Service Min TCP Hdr Size** - Specify the Min TCP Hdr Size allowed. If First Fragment DoS prevention is enabled, the switch will drop packets that have a TCP header smaller than this configured Min TCP Hdr Size. The factory default is disabled.

**Denial of Service TCP Fragment** - Enable or disable this option by selecting the corresponding line on the pulldown entry field. Enabling TCP Fragment DoS prevention causes the switch to drop packets that have an IP fragment offset equal to 1. The factory default is disabled.

**Denial of Service TCP Flag** - Enable or disable this option by selecting the corresponding line on the pulldown entry field. Enabling TCP Flag DoS prevention causes the switch to drop packets that have TCP flag SYN set and TCP source port less than 1024 or TCP control flags set to 0 and TCP sequence number set to 0 or TCP flags FIN, URG, and PSH set and TCP sequence number set to 0 or both TCP flags SYN and FIN set. The factory default is disabled.

**Denial of Service L4 Port** - Enable or disable this option by selecting the corresponding line on the pulldown entry field. Enabling L4 Port DoS prevention causes the switch to drop packets that have TCP/UDP source port equal to TCP/UDP destination port. The factory default is disabled.

**Denial of Service ICMP** - Enable or disable this option by selecting the corresponding line on the pulldown entry field. Enabling ICMP DoS prevention causes the switch to drop ICMP packets that have a type set to ECHO\_REQ (ping) and a size greater than the configured ICMP Pkt Size. The factory default is disabled.



**Denial of Service Max ICMP Pkt Size** - Specify the Max ICMP Pkt Size allowed. If ICMP DoS prevention is enabled, the switch will drop ICMP ping packets that have a size greater than this configured Max ICMP Pkt Size. The factory default is disabled.

**Denial of Service Max ICMPv6 Pkt Size** - Specify the Max ICMPv6 Pkt Size allowed. If ICMP DoS prevention is enabled, the switch will drop ICMPv6 ping packets that have a size greater than this configured Max ICMPv6 Pkt Size. The factory default is disabled.

### Command Buttons

**Submit** - Update the switch with the values on the screen. If you want the switch to retain the new values across a power cycle you must perform a save.

Denial of Service Configuration

 **Print**
 **Reload**
 **Help**

Denial of Service SIP=DIP	<input type="text" value="Disable"/>
Denial of Service First Fragment	<input type="text" value="Disable"/>
Denial of Service Min TCP Hdr Size	<input type="text" value="20"/> (0 to 255)
Denial of Service TCP Fragment	<input type="text" value="Disable"/>
Denial of Service TCP Flag	<input type="text" value="Disable"/>
Denial of Service L4 Port	<input type="text" value="Disable"/>
Denial of Service ICMP	<input type="text" value="Disable"/>
Denial of Service Max ICMP Size	<input type="text" value="512"/> (0 to 1023)
Denial of Service Max ICMPv6 Size	<input type="text" value="512"/> (0 to 1023)

### 11.2.1.4 Defining Forwarding Database

#### 11.2.1.4.1. Configuring MAC Table aging interval time Page

Use this panel to set the Address Ageing Timeout for the forwarding database.

##### Configurable Data

**Aging Interval(secs)** - The forwarding database contains static entries, which are never aged out, and dynamically learned entries, which are removed if they are not updated within a given time. You specify that time by entering a value for the Address Ageing Timeout. You may enter any number of seconds between 10 and 1000000. IEEE 802.1D recommends a default of 300 seconds, which is the factory default.

##### Command Buttons

**Submit** - Update the switch with the values on the screen. If you want the switch to retain the new values across a power cycle you must perform a save.

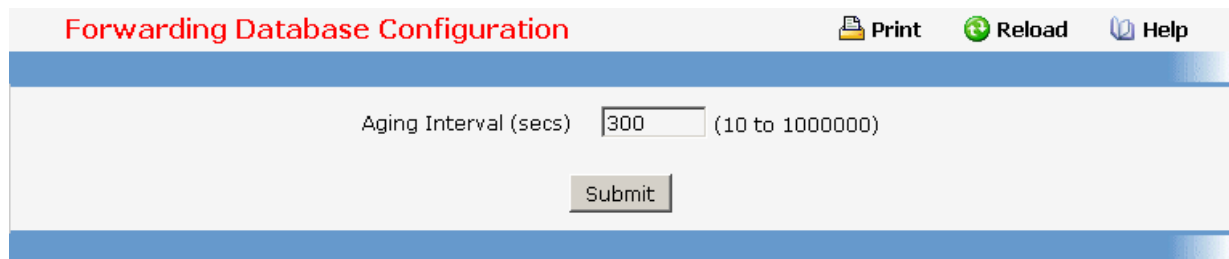

#### 11.2.1.4.2. Viewing Forwarding Database Page

Use this panel to display information about entries in the forwarding database. These entries are used by the transparent bridging function to determine how to forward a received frame.

##### Configurable Data

**Filter** - Specify the entries you want displayed.

**Learned:** If you choose "learned" only MAC addresses that have been learned will be displayed.

**All:** If you choose "all" the whole table will be displayed.

**MAC Address Search** - You may also search for an individual MAC address. Enter the two byte hexadecimal VLAN ID followed by the six byte hexadecimal MAC address in two-digit groups separated by colons, for example 01:23:45:67:89:AB:CD:EF where 01:23 is the VLAN ID and 45:67:89:AB:CD:EF is the MAC address. Then click on the search button. If the address exists, that entry will be displayed as the first entry followed by the remaining (greater) MAC addresses. An exact match is required.

##### Non-Configurable Data

**MAC Address** - A unicast MAC address for which the switch has forwarding and/or filtering information. The format is a two byte hexadecimal VLAN ID number followed by a six byte MAC address with each byte separated by colons. For example: 01:23:45:67:89:AB:CD:EF, where 01:23 is the VLAN ID and 45:67:89:AB:CD:EF is the

MAC address.

**Source Slot/Port** - the port where this address was learned -- that is, the port through which the MAC address can be reached.

**ifIndex** - The ifIndex of the MIB interface table entry associated with the source port.

**Status** - The status of this entry. The possible values are:

**Static:** the entry was added when a static MAC filter was defined.

**Learned:** the entry was learned by observing the source MAC addresses of incoming traffic, and is currently in use.

**Management:** the system MAC address, which is identified with interface 0.1.

**Self:** the MAC address of one of the switch's physical interfaces.

### Command Buttons

**Search** - Search for the specified MAC address.

**Refresh** - Refetch the database and display it again starting with the first entry in the table.

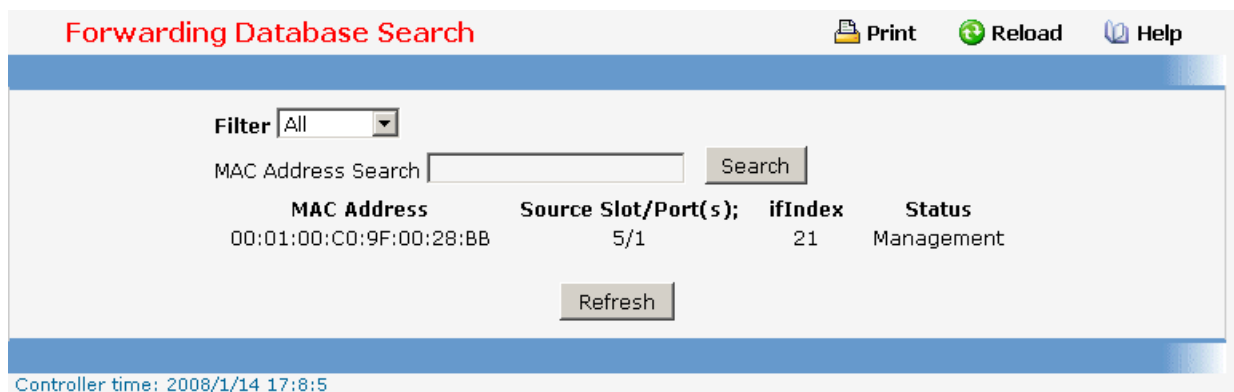

**Forwarding Database Search** Print Reload Help

Filter: All

MAC Address Search:  Search

MAC Address	Source Slot/Port(s);	ifIndex	Status
00:01:00:C0:9F:00:28:BB	5/1	21	Management

Refresh

Controller time: 2008/1/14 17:8:5

### 11.2.1.5 Viewing Logs

#### 11.2.1.5.1 Viewing Buffered Log Configuration Page

This log stores messages in memory based upon the settings for message component and severity.

#### Configurable Data



**Admin Status** - A log that is "Disabled" shall not log messages. A log that is "Enabled" shall log messages. Enable or Disable logging by selecting the corresponding line on the pulldown entry field.

**Behavior** Indicates the behavior of the log when it is full. It can either wrap around or stop when the log space is filled.

#### Command Buttons

**Submit** - Update the switch with the values you entered.

**Buffered Log Configuration**

 **Print**
 **Reload**
 **Help**

Admin Status

Behavior

#### 11.2.1.5.2. Viewing Buffered Log Page

This help message applies to the format of all logged messages which are displayed for the buffered log, persistent log, or console log.

#### Format of the messages

**<15>Aug 24 05:34:05 STK0 MSTP[2110]: mspt\_api.c(318) 237 %% Interface 12 transitioned to root state on message age timer expiry**

-The above example indicates a user-level message (1) with severity 7 (debug) on a system that is not stack and generated by component MSTP running in thread id 2110 on Aug 24 05:34:05 by line 318 of file mspt\_api.c. This is the 237th message logged. Messages logged to a collector or relay via syslog have an identical format to the above message.

#### Note for buffered log

**Number of log messages displayed:** For the buffered log, only the latest 128 entries are displayed on the webpage



#### Command Buttons

**Refresh** - Refresh the page with the latest log entries.

**Clear Log** - Clear all entries in the log.



Buffered Logs

 Print
  Reload
  Help

Total number of Messages 12

```

<14> JAN 14 17:16:20 192.168.2.2-1 UNKN[431814016]: sshd_control.c(455) 1 %% SSHD: sshdListenTask started
<14> JAN 14 17:16:20 192.168.2.2-1 UNKN[408532720]: sshd_main.c(624) 2 %% SSHD: successfully opened file ssh_host_dsa_key
<14> JAN 14 17:16:20 192.168.2.2-1 UNKN[408532720]: sshd_main.c(637) 3 %% SSHD: successfully loaded DSA key
<14> JAN 14 17:16:20 192.168.2.2-1 UNKN[408532720]: sshd_main.c(659) 4 %% SSHD: successfully opened file ssh_host_rsa_key
<14> JAN 14 17:16:20 192.168.2.2-1 UNKN[408532720]: sshd_main.c(671) 5 %% SSHD: successfully loaded RSA2 key
<14> JAN 14 17:16:24 192.168.2.2-1 UNKN[408532720]: sshd_main.c(358) 6 %% SSHD: Done generating server key
<14> JAN 14 17:16:24 192.168.2.2-1 UNKN[431814016]: sshd_control.c(248) 7 %% SSHD: deleting sshdListenTask
<14> JAN 14 17:16:24 192.168.2.2-1 UNKN[431814016]: sshd_control.c(475) 8 %% SSHD: sshdListenTask deleted
<14> JAN 14 17:16:24 192.168.2.2-1 UNKN[408532720]: sshd_main.c(1471) 9 %% SSHD: select error: S_iousLib_INVALID_FILE_DESCRIPTOR
<14> JAN 14 17:16:24 192.168.2.2-1 UNKN[408532720]: sshd_main.c(1714) 10 %% SSHD: Received signal 0. Exiting 408532720.
<14> JAN 14 17:16:24 192.168.2.2-1 UNKN[408532720]: ssh_sys_fastpath.c(430) 11 %% SSHD: exiting global context 0x1f483ec
<14> JAN 14 17:16:24 192.168.2.2-1 UNKN[408532720]: ssh_sys_fastpath.c(801) 12 %% tid 0x1859b6f0, global context 0x1f483ec, deleting self tid 0x1859b6f0, retval = 1
          
```

Controller time: 2008/1/14 17:21:44

### 11.2.1.5.3. Configuring Command Logger Page



#### Configurable Data

**Admin Mode** - Enable/Disable the operation of the CLI Command logging by selecting the corresponding pulldown field and clicking Submit.

#### Command Buttons

**Submit** - Update the switch with the values you entered.

Command Logger Configuration

 Print
  Reload
  Help

Admin Mode

#### 11.2.1.5.4. Configuring Console Log Page

This allows logging to any serial device attached to the host.

##### Configurable Data

**Admin Status** -A log that is "Disabled" shall not log messages. A log that is "Enabled" shall log messages. Enable or Disable logging by selecting the corresponding line on the pulldown entry field.

**Severity Filter** - A log records messages equal to or above a configured severity threshold. Select the severity option by selecting the corresponding line on the pulldown entry field. These severity levels have been enumerated below:

- Emergency (0): system is unusable
- Alert (1): action must be taken immediately
- Critical (2): critical conditions
- Error (3): error conditions
- Warning (4): warning conditions
- Notice(5): normal but significant conditions
- Info (6): informational messages
- Debug(7): debug-level messages

##### Command Buttons

**Submit** - Update the switch with the values you entered.

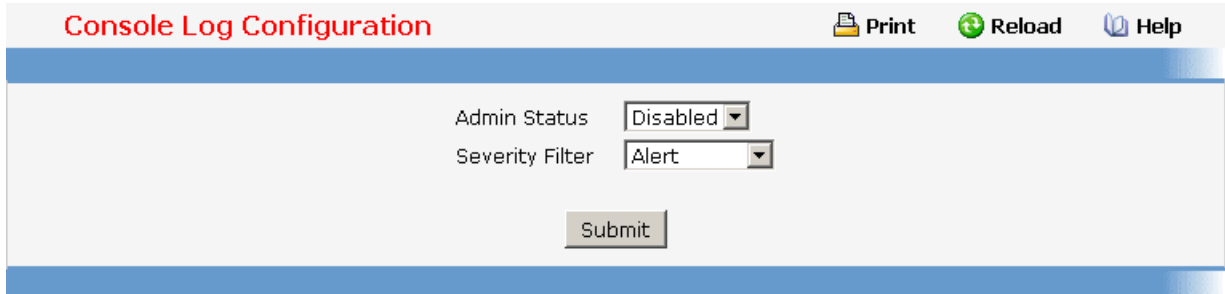

#### 11.2.1.5.5. Viewing Event Log Page

Use this panel to display the event log, which is used to hold error messages for catastrophic events. After the event is logged and the updated log is saved in FLASH memory, the switch will be reset. The log can hold at least 2,000 entries (the actual number depends on the platform and OS), and is erased when an attempt is made to add an entry after it is full. The event log is preserved across system resets.

##### Non-Configurable Data

**Entry** - The number of the entry within the event log. The most recent entry is first.

**Filename** - The FASTPATH source code filename identifying the code that detected the event.

**Line** - The line number within the source file of the code that detected the event.

**Task ID** - The OS-assigned ID of the task reporting the event.

**Code** - The event code passed to the event log handler by the code reporting the event.

**Time** - The time the event occurred, measured from the previous reset.

### Command Buttons

**Refresh** - Update the information on the page.

**Clear Log** - Remove all log information.

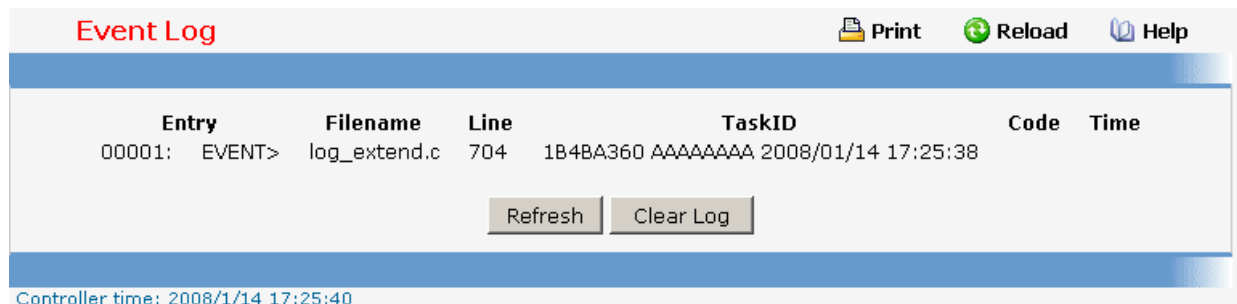

Entry	Filename	Line	TaskID	Code	Time
00001: EVENT>	log_extend.c	704	1B4BA360 AAAAAAAAAA		2008/01/14 17:25:38

Controller time: 2008/1/14 17:25:40

### 11.2.1.5.6. Configuring Hosts configuration Page

#### Configurable Data

**Host** - This is a list of the hosts that have been configured for syslog. Select a host for changing the configuration or choose to add a new hosts from the drop down list.

**IP Address** - This is the ip address of the host configured for syslog.

**Port** -This is the port on the host to which syslog messages are sent. The default port is 514. Specify the port in the text field.

**Severity Filter** -A log records messages equal to or above a configured severity threshold. Select the severity option by selecting the corresponding line on the pulldown entry field. These severity levels have been enumerated below:

- Emergency (0): system is unusable
- Alert (1): action must be taken immediately
- Critical (2): critical conditions
- Error (3): error conditions
- Warning (4): warning conditions
- Notice(5): normal but significant conditions
- Informational(6): informational messages
- Debug(7): debug-level messages

#### Non Configurable Data

**Status** -This specifies wether the host has been configured to be actively logging or not.

#### Command Buttons

**Submit** - Update the switch with the values you entered.

**Refresh** - Refetch the database and display it again starting with the first entry in the table.

**Delete** - Delete a configured host.

**Refresh** – Refresh the page with the latest log entries.

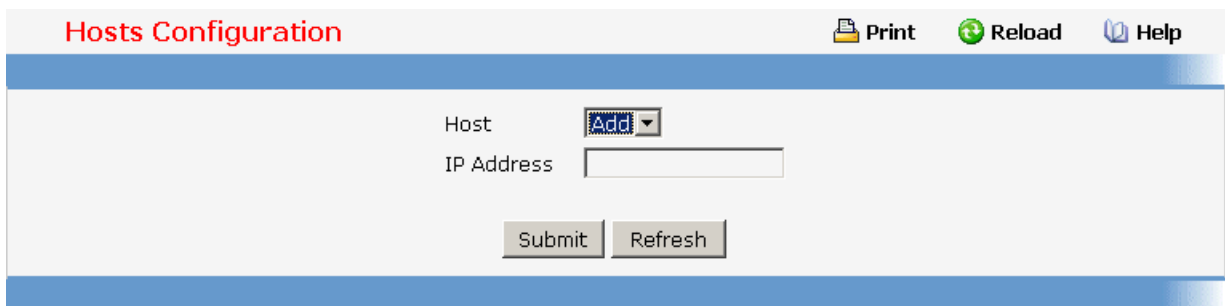

**Hosts Configuration** Print Reload Help

Host

IP Address

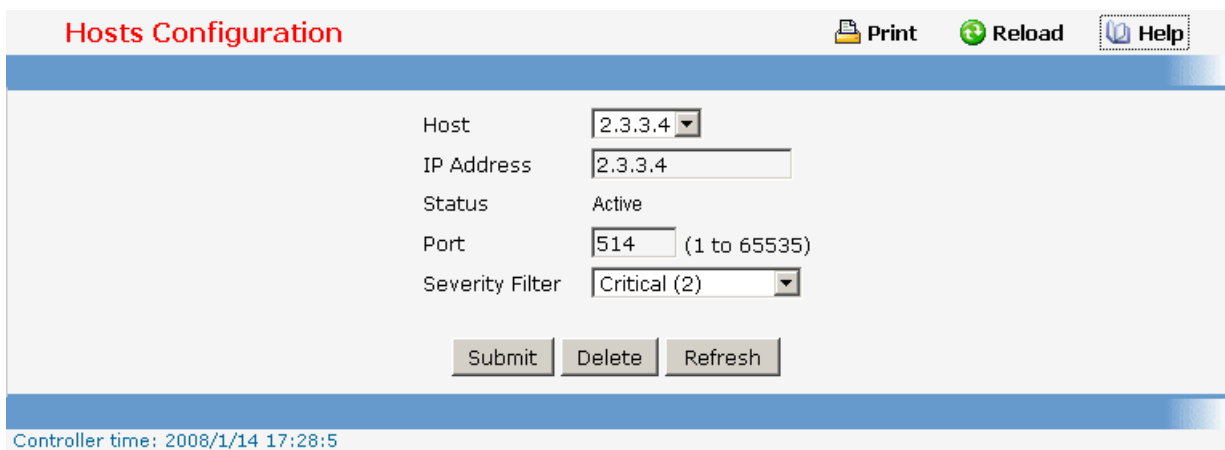

**Hosts Configuration** Print Reload Help

Host

IP Address

Status

Port  (1 to 65535)

Severity Filter

Controller time: 2008/1/14 17:28:5

### 11.2.1.5.7. Configuring syslog configuration Page

#### Configurable Data

**Admin Status** -For Enabling and Disabling logging to configured syslog hosts. Setting this to disable stops logging to all syslog hosts. Disable means no messages will be sent to any collector/relay. Enable means messages will be sent to configured collector/relays using the values configured for each collector/relay. Enable/Disable the operation of the syslog function by selecting the corresponding line on the pulldown entry field.

**Local UDP Port** This is the port on the local host from which syslog messages are sent. The default port is 514. Specify the local port in the text field.

#### Non-Configurable Data

**Messages Received** - The number of messages received by the log process. This includes messages that are dropped or ignored.

**Messages Dropped** - The number of messages that could not be processed due to error or lack of resources.

**Messages Relayed** - The number of messages forwarded by the syslog function to a syslog host. Messages forwarded to multiple hosts are counted once for each host.

### Command Buttons

**Submit** - Update the switch with the values you entered.

**Refresh** - Refetch the database and display it again starting with the first entry in the table.

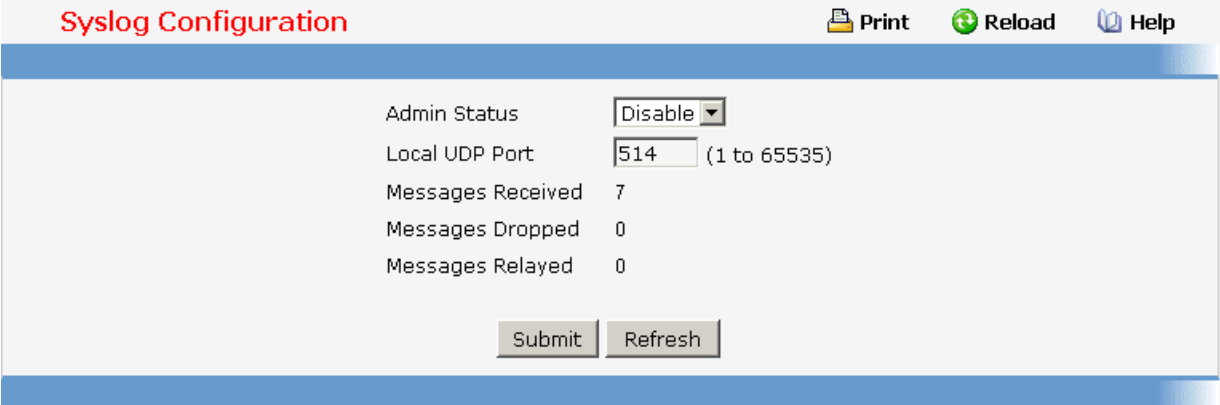

## 11.2.1.6 Managing Switch Interface

### 11.2.1.6.1. Configuring Switch Interface Page

#### Selection Criteria

**Slot/Port** - Selects the interface for which data is to be displayed or configured.

#### Configurable Data

**STP Mode** - The Select the Spanning Tree Protocol Administrative Mode for the port or **LAG**. The possible values are:

Enable - select this to enable the Spanning Tree Protocol for this port.

Disable - select this to disable the Spanning Tree Protocol for this port.

**Admin Mode** - Use the pulldown menu to select the Port control administration state. You must select enable if you want the port to participate in the network. The factory default is enabled.

**LACP Mode** - Selects the Link Aggregation Control Protocol administration state. The mode must be enabled in order for the port to participate in Link Aggregation. May be enabled or disabled by selecting the corresponding line on the pulldown entry field. The factory default is enabled.

**Physical Mode** - Use the pulldown menu to select the port's speed and duplex mode. If you select auto the duplex mode and speed will be set by the auto-negotiation process. Note that the port's maximum capability (full duplex and 100 Mbps) will be advertised. Otherwise, your selection will determine the port's duplex mode and transmission rate. The factory default is auto. The selection when applied against the "All" option in Slot/Port is applied to all applicable interfaces only.

**Host Mode** - Selects the dot1x protocol host type. Single-host means accept only one user on this port. Multi-host means accept multi users on this port.

**Link Trap** - This object determines whether or not to send a trap when link status changes. The factory default is enabled.

**Maximum Frame Size** - The maximum Ethernet frame size the interface supports or is configured, including Ethernet header, CRC, and payload. (1518 to 9216). The default maximum frame size is 1518 .

**Flow Control** - Used to enable or disable flow control feature on the selected interface.

**Broadcast Storm Control** - Used to enable or disable the broadcast storm feature on the selected interface. The broadcast storm control value can be set to Level 1, Level 2, Level 3, and Level 4.

The following description is for the broadcast storm, multicast storm, and unicast storm control.

The actual packet rate for switch will convert from the input level and the speed of that interface. (see table 1 and table 2)

Table 1. For 10/100Mbps/1Gbps		Table 2. For 10Gbps	
Level	Packet Rate (pps)	Level	Packet Rate (pps)
1	64	1	1042
2	128	2	2048
3	256	3	3124
4	512	4	4167

**Multicast Storm Control** - Used to enable or disable the multicast storm feature on the selected interface. Multicast storm control value could be set Level 1, Level 2, Level 3, and Level 4.

**Unicast Storm Control** - Used to enable or disable unicast storm feature on the selected interface. Unicast storm control value could be set Level 1, Level 2, Level 3, and Level 4.

**Capability** - You could advertise the port capabilities of a given interface during

auto-negotiation.

**Non-Configurable Data**

**Port Type** - For normal ports this field will be blank. Otherwise the possible values are:

Mon - the port is a monitoring port. Look at the Port Monitoring screens for more information.

LAG - the port is a member of a Link Aggregation trunk. Look at the LAG screens for more information.

**Physical Status** - Indicates the port speed and duplex mode.



**Link Status** - Indicates whether the Link is up or down.

**ifIndex** - The ifIndex of the interface table entry associated with this port.

**Command Buttons**

**Submit** - Update the switch with the values you entered. If you want the switch to retain the new values across a power cycle you must perform a save.

Port Configuration

 Print
 Reload
 Help

---

Slot/Port	<input type="text" value="All"/>
Port Type	
STP Mode	<input type="text" value="Disable"/>
Admin Mode	<input type="text" value="Enable"/>
LACP Mode	<input type="text" value="Enable"/>
Host Mode	<input type="text" value="Multi-host"/>
Physical Mode	<input type="text" value="Auto"/>
Physical Status	
Link Status	
Link Trap	<input type="text" value="Enable"/>
Maximum Frame Size	<input type="text" value="1518"/> (1518 to 9216)
ifIndex	
Flow Control	<input type="text" value="Disable"/>
Broadcast Storm Control	<input type="text" value="Disable"/>
Multicast Storm Control	<input type="text" value="Disable"/>
Unicast Storm Control	<input type="text" value="Disable"/>
Capability	<div style="border: 1px solid #000; background-color: #000080; color: white; padding: 5px;">           10 Mbps Half Duplex            10 Mbps Full Duplex            100 Mbps Half Duplex            100 Mbps Full Duplex            1000 Mbps Full Duplex         </div>

### 11.2.1.6.2. Viewing Switch Interface Configuration Page

This screen displays the status for all ports in the box.

#### Selection Criteria

**MST ID** - Select the Multiple Spanning Tree instance ID from the list of all currently configured MST ID's to determine the values displayed for the Spanning Tree parameters. Changing the selected MST ID will generate a screen refresh. If Spanning Tree is disabled this will be a static value, CST, instead of a selector.

#### Non-Configurable Port Status Data

**Slot/Port** - Identifies the port

**Port Type** - For normal ports this field will be blank. Otherwise the possible values are:

Mon - this port is a monitoring port. Look at the Port Monitoring screens for more information.

LAG - the port is a member of a Link Aggregation trunk. Look at the LAG screens for more information.

**STP Mode** - The Spanning Tree Protocol Administrative Mode associated with the port or LAG. The possible values are:

Enable - spanning tree is enabled for this port.

Disable - spanning tree is disabled for this port.

**Forwarding State** - The port's current state Spanning Tree state. This state controls what action a port takes on receipt of a frame. If the bridge detects a malfunctioning port it will place that port into the broken state. The other five states are defined in IEEE 802.1D:

Disabled

Blocking

Listening

Learning

Forwarding

Broken

**Port Role** - Each MST Bridge Port that is enabled is assigned a Port Role for each spanning tree. The port role will be one of the following values: Root Port, Designated Port, Alternate Port, Backup Port, Master Port, or Disabled Port.

**Admin Mode** - The Port control administration state. The port must be enabled in order for it to be allowed into the network. The factory default is enabled.

**LACP Mode** - Indicates the Link Aggregation Control Protocol administration state. The mode must be enabled in order for the port to participate in Link Aggregation.

**Physical Mode** - Indicates the port speed and duplex mode. In auto-negotiation mode the duplex mode and speed are set from the auto-negotiation process.

**Physical Status** - Indicates the port speed and duplex mode.

**Link Status** - Indicates whether the Link is up or down.

**Link Trap** - Indicates whether or not the port will send a trap when link status changes.

**ifIndex** - Indicates the ifIndex of the interface table entry associated with this port.



**Flow Control** - Indicates the status of flow control on this port.

**Packet Burst** - Indicates the packet burst used in the rate limit function if the rate limit admin mode is enabled.

**Broadcast Storm Control** - Indicates the status of the broadcast storm control, disable or Level 1, Level 2, Level 3, Level 4.



**Multicast Storm Control** - Indicates the status of the multicast storm control, disable or Level 1, Level 2, Level 3, Level 4.

**Unicast Storm Control** - Indicates the status of the unicast storm control, disable or Level 1, Level 2, Level 3, Level 4.

**Capability** - Indicates the port capabilities during auto-negotiation.

### Command Buttons

**Refresh** – Refresh the configuration value again.

Port Summary							 Print	 Reload
MST ID : CST								
Slot/Port	Port Type	STP Mode	Forwarding State	Port Role	Admin Mode	LACP Mode		
0/1		Disabled	Disabled	Disabled	Enable	Enable		
0/2		Disabled	Disabled	Disabled	Enable	Enable		
0/3		Disabled	Disabled	Disabled	Enable	Enable		
0/4		Disabled	Disabled	Disabled	Enable	Enable		
0/5		Disabled	Disabled	Disabled	Enable	Enable		
0/6		Disabled	Disabled	Disabled	Enable	Enable		
0/7		Disabled	Disabled	Disabled	Enable	Enable		
0/8		Disabled	Disabled	Disabled	Enable	Enable		
0/9		Disabled	Disabled	Disabled	Enable	Enable		
0/10		Disabled	Disabled	Disabled	Enable	Enable		
0/11		Disabled	Disabled	Disabled	Enable	Enable		
0/12		Disabled	Disabled	Disabled	Enable	Enable		
0/13		Disabled	Disabled	Disabled	Enable	Enable		
0/14		Disabled	Disabled	Disabled	Enable	Enable		
0/15		Disabled	Disabled	Disabled	Enable	Enable		
0/16		Disabled	Disabled	Disabled	Enable	Enable		
0/17		Disabled	Disabled	Disabled	Enable	Enable		

### 11.2.1.6.3. Configuring Port Description Function Page

This screen configures and displays the description for all ports in the box.

**Selection Criteria**

**Slot/Port** - Selects the interface for which data is to be displayed or configured.

**Configurable Data**

**Port Description** Enter the Description string to be attached to a port. It can be up to 64 characters in length.

**Non-Configurable Data**

**Slot/Port** - Identifies the port

**Physical Address** - Displays the physical address of the specified interface.

**PortList Bit Offset** - Displays the bit offset value which corresponds to the port when the MIB object type PortList is used to manage in SNMP.



**IfIndex** - Displays the interface index associated with the port.

**Port Description** - Description string attached to a port. It can be of up to 64 characters in length.

**Command Buttons**

**Submit** - Send the updated screen to the switch and cause the changes to take effect on the switch.

**Refresh** - Refresh the data on the screen with present state of data in the switch.

Port Description				
		<div style="text-align: right;">  Print            Reload            Help         </div>		
		Slot/Port	<input type="text" value="0/1"/>	
		Port Description	<input type="text"/>	
Slot/Port	Physical Address	PortList Bit Offset	ifIndex	Port Description
0/1	00:C0:9F:31:32:37	1	1	
0/2	00:C0:9F:31:32:37	2	2	
0/3	00:C0:9F:31:32:37	3	3	
0/4	00:C0:9F:31:32:37	4	4	
0/5	00:C0:9F:31:32:37	5	5	
0/6	00:C0:9F:31:32:37	6	6	
0/7	00:C0:9F:31:32:37	7	7	
0/8	00:C0:9F:31:32:37	8	8	
0/9	00:C0:9F:31:32:37	9	9	
0/10	00:C0:9F:31:32:37	10	10	
0/11	00:C0:9F:31:32:37	11	11	
0/12	00:C0:9F:31:32:37	12	12	
0/13	00:C0:9F:31:32:37	13	13	
0/14	00:C0:9F:31:32:37	14	14	
0/15	00:C0:9F:31:32:37	15	15	

#### 11.2.1.6.4. Configuring Multiple Port Mirroring Function Page

##### Configurable Data

**Session** - Select a port mirroring session from the list. The number of sessions allowed is platform specific. By default the First Session is selected. Up to 1 sessions are supported.

**Mode** - Specifies the Session Mode for a selected session ID. The default Session Mode is disabled.

**Source Port(s)** - Specifies the source port(s) with directions as mirrored port(s). Traffic of the source port(s) is sent to the probe port. Up to 20 source ports can be selected per session.

**Destination Port** - Acts as a probe port and will receive all the traffic from configured mirrored port(s). Default value is blank.

##### Command Buttons

**Add Source Ports** - To add Source Port(s) to the selected session.

**Remove Source Ports** - To remove the configured Source Port(s) of the selected session.

**Submit** - Send the updated screen to the switch and cause the changes to take effect on the switch.

**Delete** - Remove the selected session configuration.

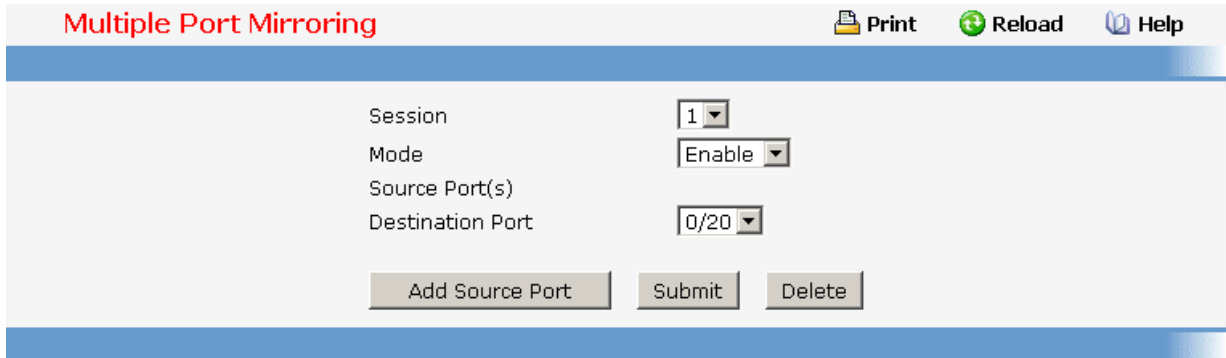
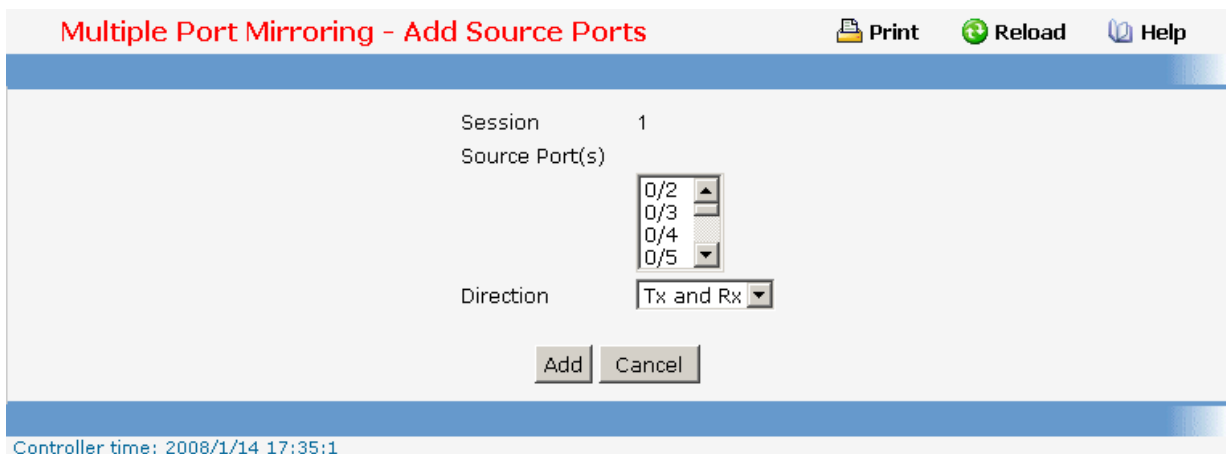
#### 11.2.1.6.5. Configuring Double VLAN Tunneling Function Page

##### Selection Criteria

**Slot/Port** - Select the physical interface for which you want to display or configure data. Select 'All' to set the parameters for all ports to same values.

##### Configurable Data

**Interface Mode** - This specifies the administrative mode via which Double VLAN Tagging can be enabled or disabled. The default value for this is Disabled.

**Interface EtherType** - The two-byte hex EtherType to be used as the first 16 bits of the DVlan tag.

- **802.1Q Tag** - Commonly used tag representing 0x8100
- **vMAN Tag** - Commonly used tag representing 0x88A8

- **Custom Tag** - Configure the EtherType in any range from (0 to 65535)

### Command Buttons

**Submit** - Update the switch with the values on this screen. If you want the switch to retain the new values across a power cycle, you must perform a save.

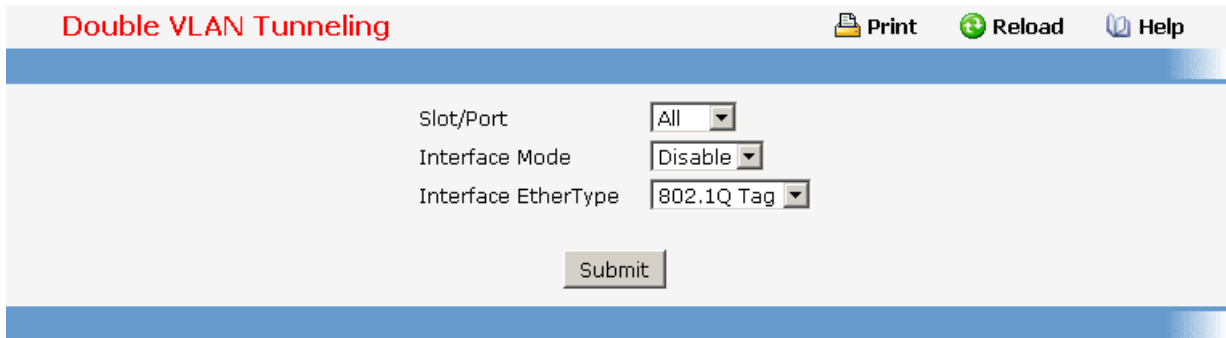

### 11.2.1.6.6. Configuring Double VLAN Tunneling Summary Function Page

#### Non-Configurable Data

**Slot/Port** - The physical interface for which data is being displayed.

**Interface Mode** - This specifies the administrative mode via which Double VLAN Tagging can be enabled or disabled. The default value for this is Disabled.

**Interface EtherType** - The two-byte hex EtherType to be used as the first 16 bits of the DVlan tag.

- **802.1Q Tag** - Commonly used tag representing 0x8100
- **vMAN Tag** - Commonly used tag representing 0x88A8
- **Custom Tag** - Configure the EtherType in any range from (0 to 65535)

### Command Buttons

**Refresh** - Refresh the data on the screen with the present state of the data in the switch.

Double VLAN Tunneling Summary			Print	Reload	Help
Slot/Port	Interface Mode	Interface EtherType			
0/1	Disable	802.1Q Tag			
0/2	Disable	802.1Q Tag			
0/3	Disable	802.1Q Tag			
0/4	Disable	802.1Q Tag			
0/5	Disable	802.1Q Tag			
0/6	Disable	802.1Q Tag			
0/7	Disable	802.1Q Tag			
0/8	Disable	802.1Q Tag			
0/9	Disable	802.1Q Tag			
0/10	Disable	802.1Q Tag			
0/11	Disable	802.1Q Tag			
0/12	Disable	802.1Q Tag			
0/13	Disable	802.1Q Tag			
0/14	Disable	802.1Q Tag			
0/15	Disable	802.1Q Tag			
0/16	Disable	802.1Q Tag			
0/17	Disable	802.1Q Tag			
0/18	Disable	802.1Q Tag			
0/19	Disable	802.1Q Tag			
0/20	Disable	802.1Q Tag			
0/21	Disable	802.1Q Tag			
0/22	Disable	802.1Q Tag			
0/23	Disable	802.1Q Tag			
0/24	Disable	802.1Q Tag			

### 11.2.1.7 Defining SNMP

#### 11.2.1.7.1. Configuring SNMP Community Configuration Page

By default, two SNMP Communities exist:

- private, with 'Read/Write' privileges and status set to enable
- public, with 'Read Only' privileges and status set to enable

These are well-known communities, you can use this menu to change the defaults or to add other communities. Only the communities that you define using this menu will have access to the switch using the SNMPv1 and SNMPv2c protocols. Only those communities with read-write level access will have access to this menu via SNMP.

You should use this menu when you are using the SNMPv1 and SNMPv2c protocol: if you want to use SNMP v3 you should use the User Accounts menu.

#### Configurable Data

**Community** - You can use this screen to reconfigure an existing community, or to create a new one. Use this pulldown menu to select one of the existing community names, or select 'Create' to add a new one.

**SNMP Community Name** - The Snmp Community Name, it identifies each SNMP community. Community names in the SNMP community must be unique. A valid entry is a case-sensitive string of up to 16 characters.

**Client IP Address** - Taken together, the Client IP Address and Client IP Mask denote a range of IP addresses from which SNMP clients may use that community to access this device. If either (IP Address or IP Mask) value is 0.0.0.0, access is allowed from any IP address. Otherwise, every client's IP address is ANDed with the mask, as is the Client IP Address, and, if the values are equal, access is allowed. For example, if the Client IP Address and Client IP Mask parameters are 192.168.1.0/255.255.255.0, then any client whose IP address is 192.168.1.0 through 192.168.1.255 (inclusive) will be allowed access. To allow access from only one station, use a Client IP Mask value of 255.255.255.255, and use that machine's IP address for Client IP Address.

**Client IP Mask** - Taken together, the Client IP Address and Client IP Mask denote a range of IP addresses from which SNMP clients may use that community to access this device. If either (IP Address or IP Mask) value is 0.0.0.0, access is allowed from any IP address. Otherwise, every client's IP address is ANDed with the mask, as is the Client IP Address, and, if the values are equal, access is allowed. For example, if the Client IP Address and Client IP Mask parameters are 192.168.1.0/255.255.255.0, then any client whose IP address is 192.168.1.0 through 192.168.1.255 (inclusive) will be allowed access. To allow access from only one station, use a Client IP Mask value of 255.255.255.255, and use that machine's IP address for Client IP Address.

**Access Mode** - Specify the access level for this community by selecting Read/Write or Read Only from the pull down menu.



**Status** - Specify the status of this community by selecting Enable or Disable from the pull down menu. If you select enable, the Community Name must be unique among all valid Community Names or the set request will be rejected. If you select disable, the Community Name will become invalid.

### Command Buttons

**Submit** - Update the switch with the values on this screen. If you want the switch to retain the new values across a power cycle, you must perform a save.

**Delete** - Delete the currently selected Community Name. If you want the switch to retain the new values across a power cycle, you must perform a save.

SNMP Community Configuration

 Print
  Reload
  Help

Community	<input type="text" value="public"/>
SNMP Community Name	<input type="text" value="public"/>
Client IP Address	<input type="text" value="0.0.0.0"/>
Client IP Mask	<input type="text" value="0.0.0.0"/>
Access Mode	<input type="text" value="Read Only"/>
Status	<input type="text" value="Enable"/>

SNMP Community Name	Client IP Address	Client IP Mask	Access Mode	Status
public	0.0.0.0	0.0.0.0	Read Only	Enable
private	0.0.0.0	0.0.0.0	Read/Write	Enable

### 11.2.1.7.2. Configuring SNMP Trap Receiver Configuration Page

This menu will display an entry for every active Trap Receiver.

#### Configurable Data

**Community** - You can use this screen to reconfigure an existing community, or to create a new one. Use this pulldown menu to select one of the existing community names, or select 'Create' to add a new one.

**SNMP Community Name** - Enter the community string for the SNMP trap packet to be sent to the trap manager. This may be up to 16 characters and is case sensitive.

**SNMP Version** - Select the trap version to be used by the receiver from the pull down menu:

SNMP v1 - Uses SNMP v1 to send traps to the receiver.

SNMP v2 - Uses SNMP v2 to send traps to the receiver.

**IP Address** - Enter the IP address to receive SNMP traps from this device. Enter 4 numbers between 0 and 255 separated by periods.

**Status** - Select the receiver's status from the pulldown menu:

Enable - send traps to the receiver.

Disable - do not send traps to the receiver.

#### Command Buttons

**Submit** - Update the switch with the values on this screen. If you want the switch to retain the new values across a power cycle, you must perform a save.

**Delete** - Delete the currently selected Community Name. If you want the switch to retain the new values across a power cycle, you must perform a save.

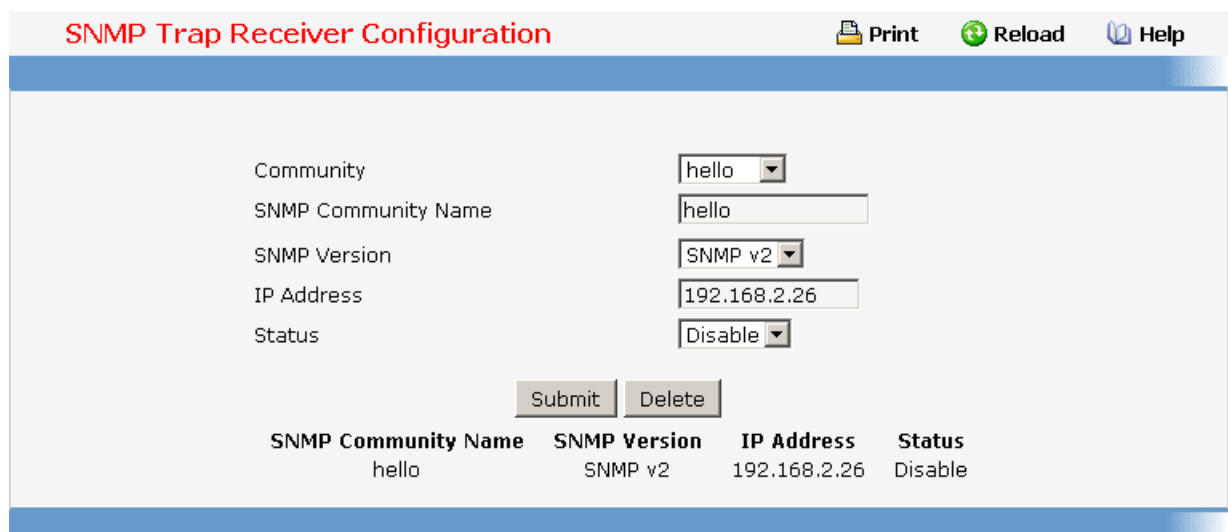

**SNMP Trap Receiver Configuration** Print Reload Help

Community: hello

SNMP Community Name: hello

SNMP Version: SNMP v2

IP Address: 192.168.2.26

Status: Disable

SNMP Community Name	SNMP Version	IP Address	Status
hello	SNMP v2	192.168.2.26	Disable



### 11.2.1.7.3. Viewing SNMP supported MIBs Page

This is a list of all the MIBs supported by the switch.

#### Non-configurable Data

**Name** - The RFC number if applicable and the name of the MIB.

**Description** - The RFC title or MIB description.

#### Command Buttons

**Refresh** - Update the data.

SNMP Supported MIBs	
Name	Description
RFC 1907 - SNMPv2-MIB	The MIB module for SNMPv2 entities
RFC 2819 - RMON-MIB	Remote Network Monitoring Management Information Base
QUANTA-SWITCH-MIB	QUANTA Computers Reference
SNMP-COMMUNITY-MIB	This MIB module defines objects to help support coexistence between SNMPv1, SNMPv2, and SNMPv3.
SNMP-FRAMEWORK-MIB	The SNMP Management Architecture MIB
SNMP-MPD-MIB	The MIB for Message Processing and Dispatching
SNMP-NOTIFICATION-MIB	The Notification MIB Module
SNMP-TARGET-MIB	The Target MIB Module
SNMP-USER-BASED-SM-MIB	The management information definitions for the SNMP User-based Security Model.
SNMP-VIEW-BASED-ACM-MIB	The management information definitions for the View-based Access Control Model for SNMP.
USM-TARGET-TAG-MIB	SNMP Research, Inc.
LAG-MIB	The Link Aggregation module for managing IEEE 802.3ad
RFC 1213 - RFC1213-MIB	Management Information Base for Network Management of TCP/IP-based internets: MIB-II
RFC 1493 - BRIDGE-MIB	Definitions of Managed Objects for Bridges (dot1d)
RFC 2674 - P-BRIDGE-MIB	The Bridge MIB Extension module for managing Priority and Multicast Filtering, defined by IEEE 802.1D-1998.
RFC 2674 - Q-BRIDGE-MIB	The VLAN Bridge MIB module for managing Virtual Bridged Local Area Networks
RFC 2737 - ENTITY-MIB	Entity MIB (Version 2)
RFC 2863 - IF-MIB	The Interfaces Group MIB using SMIPv2
RFC 3635 - Etherlike-MIB	Definitions of Managed Objects for the Ethernet-like Interface Types
SWITCHING-MIB	Switching - Layer 2
SWITCHING-EXTENSION-MIB	Switching extension - Layer 2
INVENTORY-MIB	Unit and Slot configuration.
PORTSECURITY-PRIVATE-MIB	Port Security MIB.
IEEE8021-PAE-MIB	Port Access Entity module for managing IEEE 802.1X.
TACACS-MIB	TACACS MIB
RADIUS-CLIENT-PRIVATE-MIB	Radius MIB
RADIUS-ACC-CLIENT-MIB	RADIUS Accounting Client MIB

### 11.2.1.8 Viewing Statistics

#### 11.2.1.8.1. Viewing the whole Switch Detailed Statistics Page

#### Non-Configurable Data

**ifIndex** - This object indicates the ifIndex of the interface table entry associated with the Processor of this switch.

**Octets Received** - The total number of octets of data received by the processor (excluding framing bits but including FCS octets).

**Unicast Packets Received** - The number of subnetwork-unicast packets delivered to a higher-layer protocol.

**Multicast Packets Received** - The total number of packets received that were directed to a multicast address. Note that this number does not include packets directed to the broadcast address.

**Broadcast Packets Received** - The total number of packets received that were directed to the broadcast address. Note that this does not include multicast packets.

**Receive Packets Discarded** - The number of inbound packets which were chosen to be discarded even though no errors had been detected to prevent their being deliverable to a higher-layer protocol. A possible reason for discarding a packet could be to free up buffer space.

**Octets Transmitted** - The total number of octets transmitted out of the interface, including framing characters.

**Packets Transmitted Without Errors** - The total number of packets transmitted out of the interface.

**Unicast Packets Transmitted** - The total number of packets that higher-level protocols requested be transmitted to a subnetwork-unicast address, including those that were discarded or not sent.

**Multicast Packets Transmitted** - The total number of packets that higher-level protocols requested be transmitted to a Multicast address, including those that were discarded or not sent.

**Broadcast Packets Transmitted** - The total number of packets that higher-level protocols requested be transmitted to the Broadcast address, including those that were discarded or not sent.

**Transmit Packets Discarded** - The number of outbound packets which were chosen to be discarded even though no errors had been detected to prevent their being deliverable to a higher-layer protocol. A possible reason for discarding a packet could be to free up buffer space.

**Most Address Entries Ever Used** - The highest number of Forwarding Database Address Table entries that have been learned by this switch since the most recent reboot.

**Address Entries in Use** - The number of Learned and static entries in the Forwarding Database Address Table for this switch.

**Maximum VLAN Entries** - The maximum number of Virtual LANs (VLANs) allowed on this switch.

**Most VLAN Entries Ever Used** - The largest number of VLANs that have been active on this switch since the last reboot.

**Static VLAN Entries** - The number of presently active VLAN entries on this switch that have been created statically.

**Dynamic VLAN Entries** - The number of presently active VLAN entries on this switch that have been created by GVRP registration.

**VLAN Deletes** - The number of VLANs on this switch that have been created and then deleted since the last reboot.



**Time Since Counters Last Cleared** - The elapsed time, in days, hours, minutes, and seconds, since the statistics for this switch were last cleared.

### Command Buttons

**Clear Counters** - Clear all the counters, resetting all switch summary and detailed statistics to default values. The discarded packets count cannot be cleared.

**Refresh** - Refresh the data on the screen with the present state of the data in the switch.

Switch Detailed Statistics

 [Print](#)
 [Reload](#)
 [Help](#)

ifIndex	21
Octets Received	83254
Unicast Packets Received	0
Multicast Packets Received	68
Broadcast Packets Received	311
Receive Packets Discarded	0
Octets Transmitted	7004
Packets Transmitted Without Errors	68
Unicast Packets Transmitted	0
Multicast Packets Transmitted	68
Broadcast Packets Transmitted	0
Transmit Packets Discarded	0
Most Address Entries Ever Used	6
Address Entries in Use	6
Maximum VLAN Entries	3965
Most VLAN Entries Ever Used	5
Static VLAN Entries	5
Dynamic VLAN Entries	0
VLAN Deletes	0
Time Since Counters Last Cleared	0 day 1 hr 8 min 52 sec

Clear Counters
Refresh

### 11.2.1.8.2. Viewing the whole Switch Summary Statistics Page

#### Non-Configurable Data

**ifIndex** - This object indicates the ifIndex of the interface table entry associated with the Processor of this switch.

**Broadcast Packets Received** - The total number of packets received that were directed to the broadcast address. Note that this does not include multicast packets.

**Packets Received with Errors** - The number of inbound packets that contained errors preventing them from being deliverable to a higher-layer protocol.

**Packets Transmitted Without Errors** - The total number of packets transmitted out of the interface.

**Broadcast Packets Transmitted** - The total number of packets that higher-level protocols requested to be transmitted to the Broadcast address, including those that were discarded or not sent.

**Transmit Packet Errors** - The number of outbound packets that could not be transmitted because of errors.

**Address Entries Currently in Use** - The total number of Forwarding Database Address Table entries now active on the switch, including learned and static entries.



**VLAN Entries Currently in Use** - The number of VLAN entries presently occupying the VLAN table.

**Time Since Counters Last Cleared** - The elapsed time, in days, hours, minutes, and seconds since the statistics for this switch were last cleared.

#### Command Buttons

**Clear Counters** - Clear all the counters, resetting all summary and switch detailed statistics to defaults. The discarded packets count cannot be cleared.

**Refresh** - Refresh the data on the screen with the present state of the data in the switch.

<b>Switch Summary Statistics</b>		 <b>Print</b>	 <b>Reload</b>	 <b>Help</b>
ifIndex	21			
Broadcast Packets Received	313			
Packets Received With Error	0			
Packets Transmitted Without Errors	69			
Broadcast Packets Transmitted	0			
Transmit Packet Errors	0			
Address Entries Currently in Use	3			
VLAN Entries Currently in Use	5			
Time Since Counters Last Cleared	0 day 1 hr 9 min 55 sec			
<input type="button" value="Clear Counters"/> <input type="button" value="Refresh"/>				

### 11.2.1.8.3. Viewing Each Port Detailed Statistics Page

#### Selection Criteria

**Slot/Port** - Selects the interface for which data is to be displayed or configured.

#### Non-Configurable Data

**ifIndex** - This object indicates the ifIndex of the interface table entry associated with this port on an adapter.

**Packets RX and TX 64 Octets** - The total number of packets (including bad packets) received or transmitted that were 64 octets in length (excluding framing bits but including FCS octets).

**Packets RX and TX 65-127 Octets** - The total number of packets (including bad packets) received or transmitted that were between 65 and 127 octets in length inclusive (excluding framing bits but including FCS octets).

**Packets RX and TX 128-255 Octets** - The total number of packets (including bad packets) received or transmitted that were between 128 and 255 octets in length inclusive (excluding framing bits but including FCS octets).

**Packets RX and TX 256-511 Octets** - The total number of packets (including bad packets) received or transmitted that were between 256 and 511 octets in length inclusive (excluding framing bits but including FCS octets).

**Packets RX and TX 512-1023 Octets** - The total number of packets (including bad packets) received or transmitted that were between 512 and 1023 octets in length inclusive (excluding framing bits but including FCS octets).

**Packets RX and TX 1024-1518 Octets** - The total number of packets (including bad packets) received or transmitted that were between 1024 and 1518 octets in length inclusive (excluding framing bits but including FCS octets).

**Packets RX and TX 1519-2047 Octets** - The total number of packets (including bad packets) received or transmitted that were between 1519 and 2047 octets in length inclusive (excluding framing bits but including FCS octets).

**Packets RX and TX 2048-4095 Octets** - The total number of packets (including bad packets) received or transmitted that were between 2048 and 4095 octets in length inclusive (excluding framing bits but including FCS octets).

**Packets RX and TX 4096-9216 Octets** - The total number of packets (including bad packets) received or transmitted that were between 4096 and 9216 octets in length inclusive (excluding framing bits but including FCS octets).

**Octets Received** - The total number of octets of data (including those in bad packets) received on the network (excluding framing bits but including FCS octets). This object can be used as a reasonable estimate of ethernet utilization. If greater precision is desired, the etherStatsPkts and etherStatsOctets objects should be sampled before and after a common interval.

**Packets Received 64 Octets** - The total number of packets (including bad packets) received that were 64 octets in length (excluding framing bits but including FCS octets).

**Packets Received 65-127 Octets** - The total number of packets (including bad packets) received that were between 65 and 127 octets in length inclusive (excluding framing bits but including FCS octets).

**Packets Received 128-255 Octets** - The total number of packets (including bad packets) received that were between 128 and 255 octets in length inclusive (excluding framing bits but including FCS octets).

**Packets Received 256-511 Octets** - The total number of packets (including bad packets) received that were between 256 and 511 octets in length inclusive (excluding framing bits but including FCS octets).

**Packets Received 512-1023 Octets** - The total number of packets (including bad packets) received that were between 512 and 1023 octets in length inclusive (excluding framing bits but including FCS octets).

**Packets Received 1024-1518 Octets** - The total number of packets (including bad packets) received that were between 1024 and 1518 octets in length inclusive (excluding framing bits but including FCS octets).

**Packets Received > 1522 Octets** - The total number of packets received that were longer than 1522 octets (excluding framing bits, but including FCS octets) and were otherwise well formed.

**Total Packets Received Without Errors** - The total number of packets received that were without errors.

**Unicast Packets Received** - The number of subnetwork-unicast packets delivered to a higher-layer protocol.

**Multicast Packets Received** - The total number of good packets received that were directed to a multicast address. Note that this number does not include packets directed to the broadcast address.

**Broadcast Packets Received** - The total number of good packets received that were directed to the broadcast address. Note that this does not include multicast packets.

**Total Packets Received with MAC Errors** - The total number of inbound packets that contained errors preventing them from being deliverable to a higher-layer protocol.

**Jabbers Received** - The total number of packets received that were longer than 1518 octets (excluding framing bits, but including FCS octets), and had either a bad Frame Check Sequence (FCS) with an integral number of octets (FCS Error) or a bad FCS with a non-integral number of octets (Alignment Error). Note that this definition of jabber is different than the definition in IEEE-802.3 section 8.2.1.5 (10BASE5) and section 10.3.1.4 (10BASE2). These documents define jabber as the condition where any packet exceeds 20 ms. The allowed range to detect jabber is between 20 ms and 150 ms.

**Undersize Received** - The total number of packets received that were less than 64 octets in length with GOOD CRC(excluding framing bits but including FCS octets).

**Fragments Received** - The total number of packets received that were less than 64 octets in length with ERROR CRC(excluding framing bits but including FCS octets).

**Alignment Errors** - The total number of packets received that had a length (excluding framing bits, but including FCS octets) of between 64 and 1518 octets, inclusive, but had a bad Frame Check Sequence (FCS) with a non-integral number of octets.

**Rx FCS Errors** - The total number of packets received that had a length (excluding framing bits, but including FCS octets) of between 64 and 1518 octets, inclusive, but had a bad Frame Check Sequence (FCS) with an integral number of octets

**Overruns** - The total number of frames discarded as this port was overloaded with incoming packets, and could not keep up with the inflow.

**Total Packets Transmitted (Octets)** - The total number of octets of data (including those in bad packets) transmitted on the network (excluding framing bits but including FCS octets). This object can be used as a reasonable estimate of ethernet utilization. If greater precision is desired, the etherStatsPkts and etherStatsOctets objects should be sampled before and after a common interval.

**Packets Transmitted 64 Octets** - The total number of packets (including bad packets) received that were 64 octets in length (excluding framing bits but including FCS octets).

**Packets Transmitted 65-127 Octets** - The total number of packets (including bad packets) received that were between 65 and 127 octets in length inclusive (excluding framing bits but including FCS octets).

**Packets Transmitted 128-255 Octets** - The total number of packets (including bad packets) received that were between 128 and 255 octets in length inclusive (excluding framing bits but including FCS octets).

**Packets Transmitted 256-511 Octets** - The total number of packets (including bad packets) received that were between 256 and 511 octets in length inclusive (excluding framing bits but including FCS octets).

**Packets Transmitted 512-1023 Octets** - The total number of packets (including bad packets) received that were between 512 and 1023 octets in length inclusive (excluding framing bits but including FCS octets).

**Packets Transmitted 1024-1518 Octets** - The total number of packets (including bad packets) received that were between 1024 and 1518 octets in length inclusive (excluding framing bits but including FCS octets).

**Maximum Frame Size** - The maximum ethernet frame size the interface supports or is configured, including ethernet header, CRC, and payload. (1518 to 9216). The default maximum frame size is 1518 .

**Total Packets Transmitted Successfully** - The number of frames that have been transmitted by this port to its segment.

**Unicast Packets Transmitted** - The total number of packets that higher-level protocols requested be transmitted to a subnetwork-unicast address, including those that were discarded or not sent.

**Multicast Packets Transmitted** - The total number of packets that higher-level protocols requested be transmitted to a Multicast address, including those that were discarded or not sent.

**Broadcast Packets Transmitted** - The total number of packets that higher-level protocols requested be transmitted to the Broadcast address, including those that were discarded or not sent.

**Total Transmit Errors** - The sum of Single, Multiple, and Excessive Collisions.

**Tx FCS Errors** - The total number of packets transmitted that had a length (excluding framing bits, but including FCS octets) of between 64 and 1518 octets, inclusive, but had a bad Frame Check Sequence (FCS) with an integral number of octets

**Tx Oversized** - The total number of frames that exceeded the max permitted frame size. This counter has a max increment rate of 815 counts per sec at 10 Mb/s.

**Underrun Errors** - The total number of frames discarded because the transmit FIFO buffer became empty during frame transmission.

**Total Transmit Packets Discarded** - The sum of single collision frames discarded, multiple collision frames discarded, and excessive frames discarded.

**Single Collision Frames** - A count of the number of successfully transmitted frames on a particular interface for which transmission is inhibited by exactly one collision.

**Multiple Collision Frames** - A count of the number of successfully transmitted frames on a particular interface for which transmission is inhibited by more than one collision.



**Excessive Collision Frames** - A count of frames for which transmission on a particular interface fails due to excessive collisions.

**GVRP PDUs Received** - The count of GVRP PDUs received in the GARP layer.

**GVRP PDUs Transmitted** - The count of GVRP PDUs transmitted from the GARP layer.

**GVRP Failed Registrations** - The number of times attempted GVRP registrations could not be completed.

**GMRP PDUs Received** - The count of GMRP PDUs received from the GARP layer.

**GMRP PDUs Transmitted** - The count of GMRP PDUs transmitted from the GARP layer.

**GMRP Failed Registrations** - The number of times attempted GMRP registrations could not be completed.

**STP BPDUs Received** - Number of STP BPDUs received at the selected port.

**STP BPDUs Transmitted** - Number of STP BPDUs transmitted from the selected port.

**RSTP BPDUs Received** - Number of RSTP BPDUs received at the selected port.

**RSTP BPDUs Transmitted** - Number of RSTP BPDUs transmitted from the selected port.

**MSTP BPDUs Received** - Number of MSTP BPDUs received at the selected port.

**MSTP BPDUs Transmitted** - Number of MSTP BPDUs transmitted from the selected port.

**Time Since Counters Last Cleared** - The elapsed time, in days, hours, minutes, and seconds since the statistics for this port were last cleared.

### Command Buttons

**Clear Counters** - Clear all the counters, resetting all statistics for this port to default values.

**Clear All Counters** - Clear all the counters for all ports, resetting all statistics for all ports to default values.

**Refresh** - Refresh the data on the screen with the present state of the data in the switch.

Port Detailed Statistics		Print	Reload	Help
Slot/Port	0/3			
ifIndex	3			
Packets RX and TX 64 Octets	8			
Packets RX and TX 65-127 Octets	210			
Packets RX and TX 128-255 Octets	18			
Packets RX and TX 256-511 Octets	228			
Packets RX and TX 512-1023 Octets	0			
Packets RX and TX 1024-1518 Octets	0			
Packets RX and TX 1519-2047 Octets	0			
Packets RX and TX 2048-4095 Octets	0			
Packets RX and TX 4096-9216 Octets	0			
Octets Received	84628			
Packets Received 64 Octets	8			
Packets Received 65-127 Octets	140			
Packets Received 128-255 Octets	18			
Packets Received 256-511 Octets	228			
Packets Received 512-1023 Octets	0			
Packets Received 1024-1518 Octets	0			
Packets Received > 1522 Octets	0			
Total Packets Received Without Errors	394			
Unicast Packets Received	0			
Multicast Packets Received	70			
Broadcast Packets Received	324			
Total Packets Received with MAC Errors	0			
Jabbers Received	0			
Undersize Received	0			
Fragments Received	0			
Alignment Errors	0			

Rx FCS Errors	0
Overruns	0
Total Packets Transmitted (Octets)	7210
Packets Transmitted 64 Octets	0
Packets Transmitted 65-127 Octets	70
Packets Transmitted 128-255 Octets	0
Packets Transmitted 256-511 Octets	0
Packets Transmitted 512-1023 Octets	0
Packets Transmitted 1024-1518 Octets	0
Maximum Frame Size	1518
Total Packets Transmitted Successfully	70
Unicast Packets Transmitted	0
Multicast Packets Transmitted	70
Broadcast Packets Transmitted	0
Total Transmit Errors	0
Tx FCS Errors	0
Tx Oversized	0
Underrun Errors	0
Total Transmit Packets Discarded	0
Single Collision Frames	0
Multiple Collision Frames	0
Excessive Collision Frames	0
Port Membership Discards	0
GVRP PDUs Received	0
GVRP PDUs Transmitted	0
GVRP Failed Registrations	0
GMRP PDUs Received	0
GMRP PDUs Transmitted	0
GMRP Failed Registrations	0
STP BPDUs Received	0
STP BPDUs Transmitted	0
RSTP BPDUs Received	0
RSTP BPDUs Transmitted	0
MSTP BPDUs Received	0
MSTP BPDUs Transmitted	0
Time Since Counters Last Cleared	0 day 1 hr 11 min 17 sec

#### 11.2.1.8.4. Viewing Each Port Summary Statistics Page

##### Selection Criteria

**Slot/Port** - Selects the interface for which data is to be displayed or configured.

##### Non-Configurable Data

**ifIndex** - This object indicates the ifIndex of the interface table entry associated with this port on an adapter.

**Total Packets Received without Errors** - The total number of packets received that were without errors.

**Packets Received with Errors** - The number of inbound packets that contained errors preventing them from being deliverable to a higher-layer protocol.

**Broadcast Packets Received** - The total number of good packets received that were directed to the broadcast address. Note that this does not include multicast packets.

**Packets Transmitted without Errors** - The number of frames that have been transmitted by this port to its segment.

**Transmit Packet Errors** - The number of outbound packets that could not be transmitted because of errors.

**Collision Frames** - The best estimate of the total number of collisions on this Ethernet segment.

**Time Since Counters Last Cleared** - The elapsed time, in days, hours, minutes, and seconds since the statistics for this port were last cleared.



### Command Buttons

**Clear Counters** - Clears all the counters, resetting all statistics for this port to default values.

**Clear All Counters** - Clears all the counters for all ports, resetting all statistics for all ports to default values.

**Refresh** – Refreshes the data on the screen with the present state of the data in the switch.

Port Summary Statistics

 Print
 Reload
 Help

---

Slot/Port	0/3 ▾
ifIndex	3
Total Packets Received Without Errors	420
Packets Received With Error	0
Broadcast Packets Received	346
Packets Transmitted Without Errors	73
Transmit Packet Errors	0
Collision Frames	0
Time Since Counters Last Cleared	0 day 1 hr 14 min 46 se

Clear Counters

Clear All Counters



Refresh

## 11.2.1.9 Managing System Utilities

### 11.2.1.9.1. Saving All Configuration Changed Page

#### Command Buttons

**Save** - Click this button to have configuration changes you have made saved across a system reboot. All changes submitted since the previous save or system reboot will be retained by the switch.



**Save All Applied Changes**  Print  Reload  Help

Saving all applied changes will cause all changes to configuration panels that were applied, but not saved, to be saved, thus retaining their new values across a system reboot.

#### 11.2.1.9.2. Resetting the Switch Page

##### Command Buttons

**Reset** - Select this button to reboot the switch. Any configuration changes you have made since the last time you issued a save will be lost. You will be shown a confirmation screen after you select the button.



**System Reset**  Print  Reload  Help

Resetting the switch will cause all operations of this switch to stop. This session will be broken and you will have to log in again after the switch has rebooted. Any unsaved changes will be lost.

#### 11.2.1.9.3. Restoring All Configuration to Default Values Page

##### Command Buttons

**Reset** - Clicking the Reset button will reset all of the system login passwords to their default values. If you want the switch to retain the new values across a power cycle, you must perform a save.

**Reset Configuration to Defaults**  Print  Reload  Help

Exercising this function will cause all configuration parameters to be reset to their default values.

#### 11.2.1.9.4. Resetting the Passwords to Default Values Page

##### Command Buttons

**Reset** - Select this button to have all passwords reset to their factory default values.

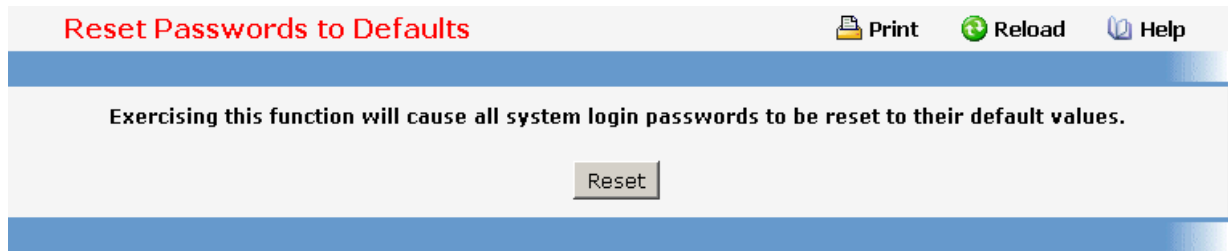

#### 11.2.1.9.5. Downloading Specific Files to Switch Flash Page

Use this menu to download a file to the switch.

##### Configurable Data

**File Type** - Specify what type of file you want to download:

**Script** - specify configuration script when you want to update the switch's script file.

**CLI Banner** - Specify the banner that you want to display before user login to the switch.

**Code** - Specify code when you want to upgrade the operational flash.

**Configuration** - Specify configuration when you want to update the switch's configuration. If the file has errors the update will be stopped.

**SSH-1 RSA Key File** - SSH-1 Rivest-Shamir-Adleman (RSA) Key File

**SSH-2 RSA Key PEM File** - SSH-2 Rivest-Shamir-Adleman (RSA) Key File (PEM Encoded)

**SSH-2 DSA Key PEM File** - SSH-2 Digital Signature Algorithm (DSA) Key File (PEM Encoded)

**SSL Trusted Root Certificate PEM File** - SSL Trusted Root Certificate File (PEM Encoded)

**SSL Server Certificate PEM File** - SSL Server Certificate File (PEM Encoded)

**SSL DH Weak Encryption Parameter PEM File** - SSL Diffie-Hellman Weak Encryption Parameter File (PEM Encoded)

**SSL DH Strong Encryption Parameter PEM File** - SSL Diffie-Hellman Strong Encryption Parameter File (PEM Encoded)

The factory default is code.

Note that to download SSH key files SSH must be administratively disabled and there can be no active SSH sessions.

**TFTP Server IP Address** - Enter the IP address of the TFTP server. The factory default is 0.0.0.0.

**TFTP File Path (Source)** - Enter the path on the TFTP server where the selected file is located. You may enter up to 32 characters. The factory default is blank.

**TFTP File Name (Source)** - Enter the name on the TFTP server of the file you want to download. You may enter up to 32 characters. The factory default is blank.

**TFTP File Name (Target)** - Enter the name on the switch of the file you want to save. You may enter up to 32 characters. The factory default is blank.

**Start File Transfer** - To initiate the download you need to check this box and then select the submit button.

### Non-Configurable Data

The last row of the table is used to display information about the progress of the file transfer. The screen will refresh automatically until the file transfer completes.

### Command Buttons

**Submit** - Send the updated screen to the switch and perform the file download.

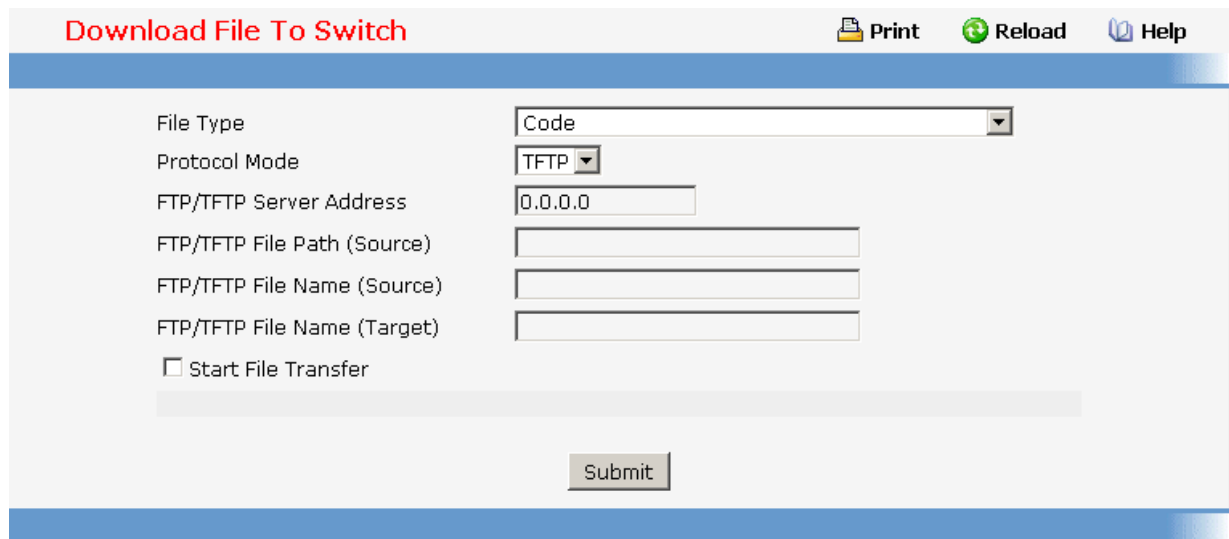

### 11.2.1.9.6. Uploading Specific Files from Switch Flash Page

Use this menu to upload a code, configuration, or log file from the switch.

### Configurable Data

**File Type** - Specify the type of file you want to upload. The available options are Script, Code, CLI Banner, Configuration, Error Log, Buffered Log, and Trap Log. The factory default is Error Log.

**TFTP Server IP Address** - Enter the IP address of the TFTP server. The factory default is 0.0.0.0

**TFTP File Path (Target)** - Enter the path on the TFTP server where you want to put the file being uploaded. You may enter up to 32 characters. The factory default is blank.

**TFTP File Name (Target)** - Enter the name you want to give the file being uploaded. You may enter up to 32 characters. The factory default is blank.

**TFTP File Name (Source)** - Specify the file which you want to upload from the switch.

**Start File Transfer** - To initiate the upload you need to check this box and then select the submit button.

### Non-Configurable Data

The last row of the table is used to display information about the progress of the file transfer. The screen will refresh automatically until the file transfer completes.

**Command Buttons**

**Submit** - Send the updated screen to the switch and perform the file upload.

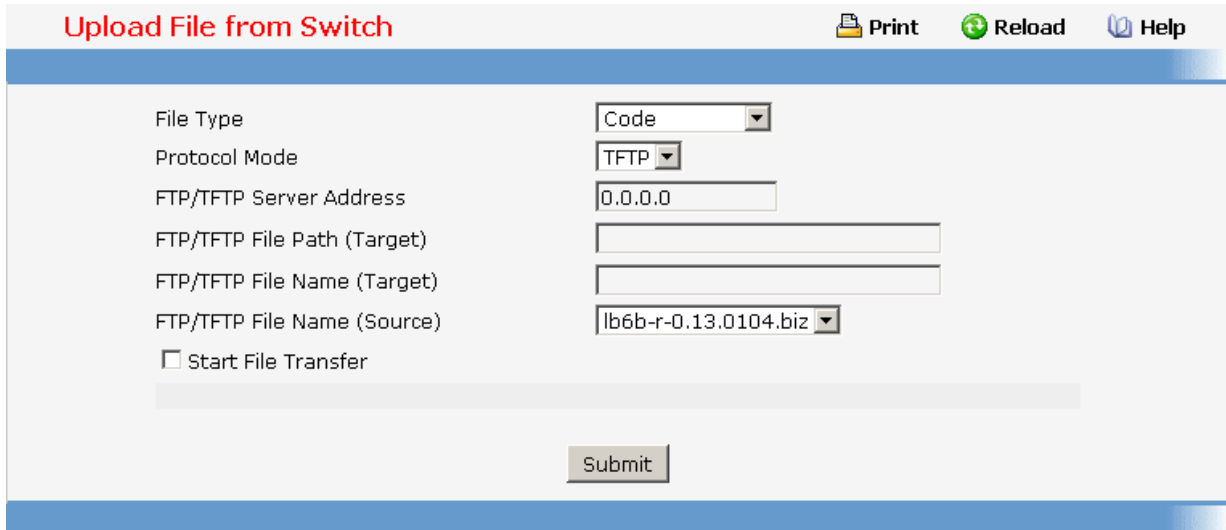

**11.2.1.9.7. Defining Configuration and Runtime Startup File Page**

Specify the file used to start up the system.

**Configurable Data**

**Configuration File** - Configuration files.

**Runtime File** - Run-time operation codes.

**Non Configurable Data**

**Current Configuration File** - Current Configuration files.

**Current Runtime File** - Current Run-time operation codes.

**Command Buttons**

**Submit** - Send the updated screen to the switch and specify the file start-up.

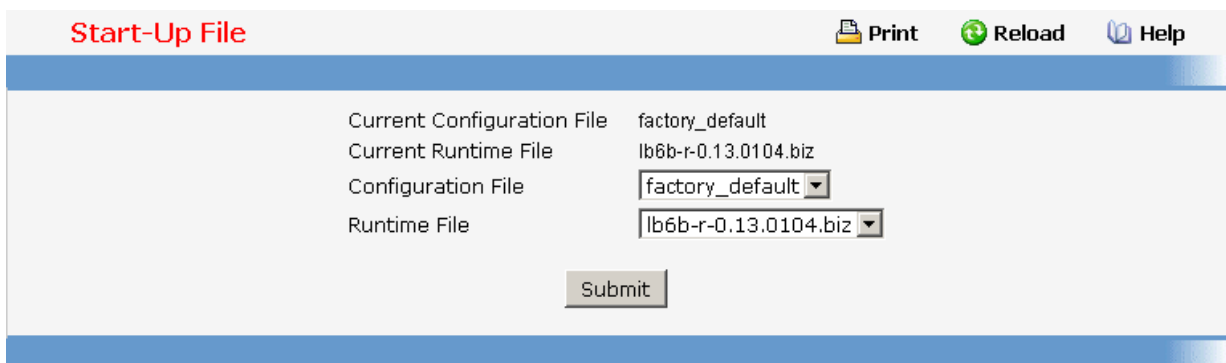



**11.2.1.9.8. Removing Specific File Page**

Delete files in flash. If the file type is used for system startup, then this file cannot be deleted.

**Configurable Data**

**Configuration File** - Configuration files.

**Runtime File** - Run-time operation codes.

**Script File** - Configuration script files.

**Command Buttons**

**Remove File** - Send the updated screen to the switch and perform the file remove.

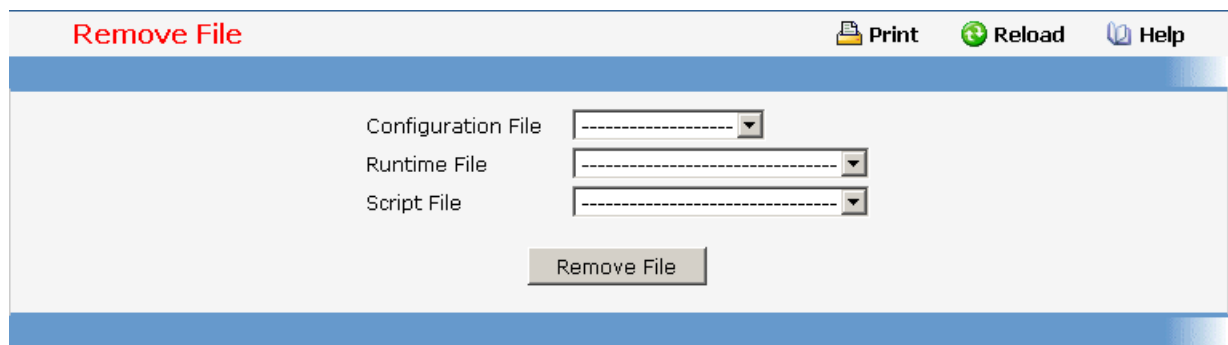

**11.2.1.9.9. Copying Running Configuration to Flash Page**

Use this menu to copy a start-up configuration file from the running configuration file on switch.

**Configurable Data**

**File Name** - Enter the name you want to give the file being copied. You may enter up to 32 characters. The factory default is blank.

**Non-Configurable Data**

The last row of the table is used to display information about the progress of the file copy. The screen will refresh automatically until the file copy completes.

**Command Buttons**

**Copy to File** - Send the updated screen to the switch perform the file copy.

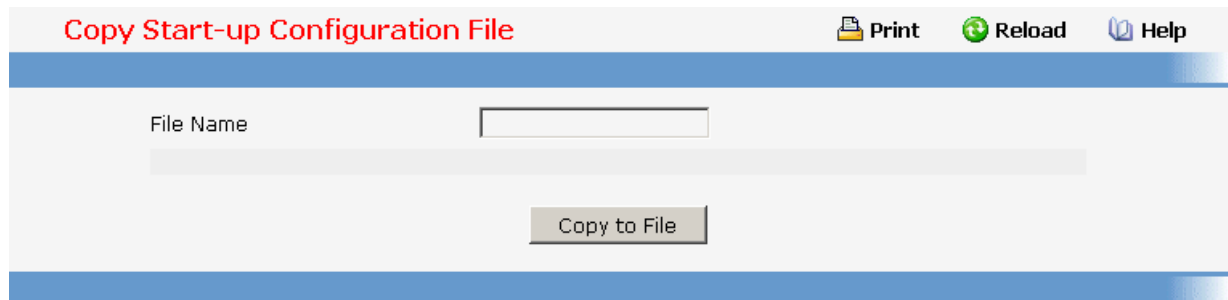

### 11.2.1.9.10. Defining Ping Function Page

Use this screen to tell the switch to send a Ping request to a specified IP address. You can use this to check whether the switch can communicate with a particular IP station. Once you click the Submit button, the switch will send three pings and the results will be displayed below the configurable data. If a reply to the ping is not received, you will see **No Reply Received from IP xxx.xxx.xxx.xxx**, otherwise you will see **Reply received from IP xxx.xxx.xxx.xxx : (send count = 5, receive count = n)**.

#### Configurable Data

**IP Address** - Enter the IP address of the station you want the switch to ping. The initial value is blank. The IP Address you enter is not retained across a power cycle.

#### None Configurable Data

**Ping** – The reply result received from switch.

#### Command Buttons

**Submit** - This will initiate the ping.

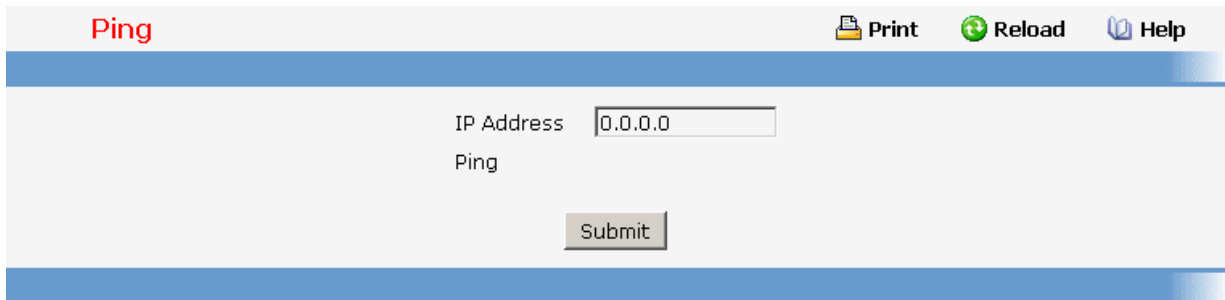

### 11.2.1.9.11. Defining Ping IPv6 Function Page

This screen is used to send a Ping request to a specified IPv6 address. You can use this to check whether the switch can communicate with a particular IPv6 station. Once you click the Submit button, the switch will send three pings and the results will be displayed below the configurable data. The output will be **Send count=3, Receive count=n from (IPv6 Address). Average round trip time = n ms**.

#### Selection Criteria

**Ping** - Select either global IPv6 Address or Link Local Address to ping.

**Interface** - Select a IPv6 interface.

#### Configurable Data

**IPv6 Address** - Enter the IPv6 address of the station you want the switch to ping. The initial value is blank. The IPv6 Address you enter is not retained across a power cycle.

**Link Local Address** - Enter the link local address of the station you want the switch to ping. The initial value is blank. The Link Local Address you enter is not retained across a power cycle.

**Datagram Size** - Enter the datagram size. The valid range is L7\_IP6\_PING\_MIN to L7\_IP6\_PING\_MAX.

**None Configurable Data**

**Ping Output**– The reply result received from switch.

**Command Buttons**

**Submit** - This will initiate the ping.

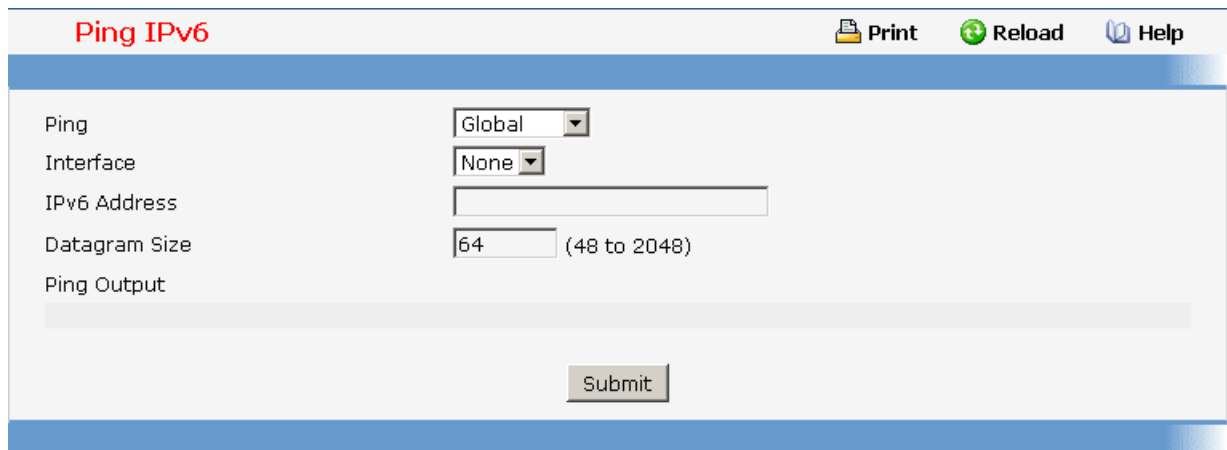

**11.2.1.9.12. TraceRoute Function**

Use this screen to tell the switch to send a TraceRoute request to a specified IP address. You can use this to discover the paths packets take to a remote destination. Once you click the Submit button, the switch will send traceroute and the results will be displayed below the configurable data. If a reply to the traceroute is you will see **1 x.y.z.w 9869 usec 9775 usec 10584 usec**

**2 0.0.0.0 0 usec \* 0 usec \* 0 usec \***

**3 0.0.0.0 0 usec \* 0 usec \* 0 usec \***

**Hop Count = w Last TTL = z Test attempt = x Test Success = y.**

**Configurable Data**

**IP Address** - Enter the IP address of the station you want the switch to discover path. The initial value is blank. The IP Address you enter is not retained across a power cycle.

**Probes Per Hop** - Enter the number of probes per hop. The initial value is default. The Probes per Hop you enter is not retained across a power cycle.

**MaxTTL** - Enter the maximum TTL for the destination. The initial value is default value. The MaxTTL you enter is not retained across a power cycle.

**InitTTL** - Enter the initial TTL to be used. The initial value is default value. The InitTTL you enter is not retained across a power cycle.

**MaxFail** - Enter the maximum Failures allowed in the session. The initial value is default value. The MaxFail you enter is not retained across a power cycle.

**Interval** - Enter the Time between probes in seconds. The initial value is default value. The Interval you enter is not retained across a power cycle.

**Port** - Enter the UDP Dest port in probe packets. The initial value is default value. The port you enter is not retained across a power cycle.

**Size** - Enter the Size of probe packets. The initial value is default value. The Size you enter is not retained across a power cycle.

### Command Buttons

**Submit** - This will initiate the traceroute.

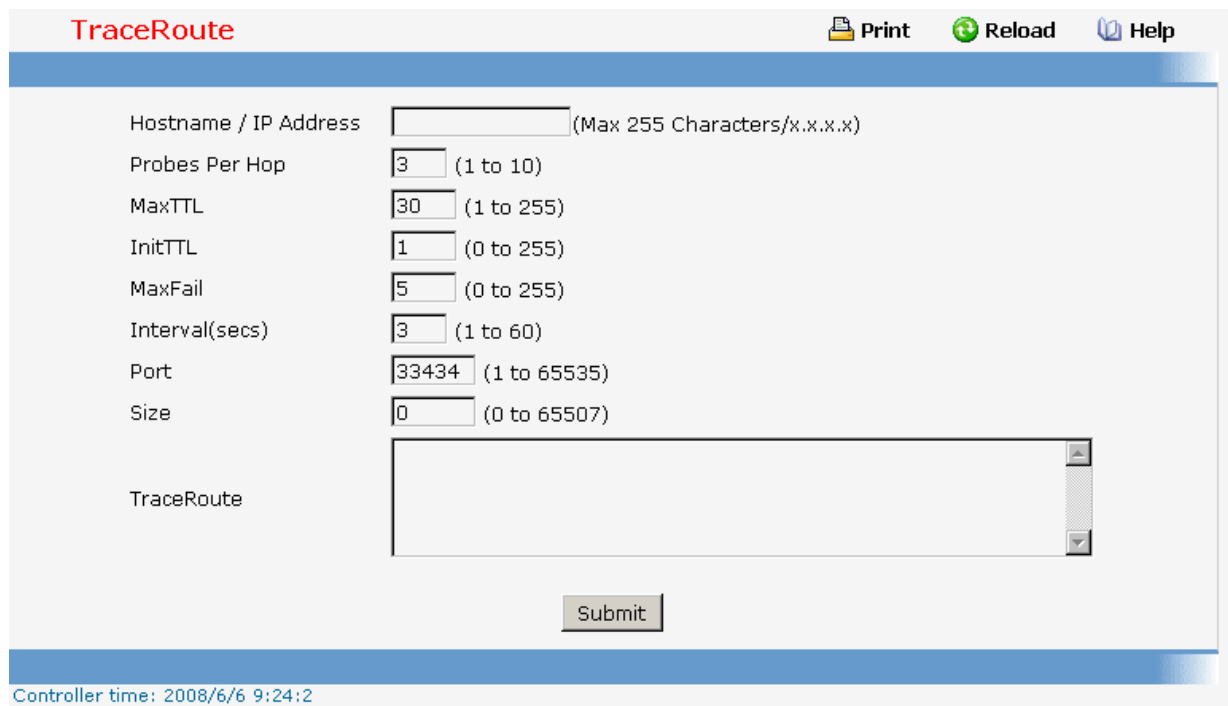

### 11.2.1.9.13. Managing CDP Function

#### Defining CDP Configuration Page

Use this menu to configure the parameters for CDP, which is used to discover a CISCO device on the LAN.

#### Configurable Data

**Admin Mode** - CDP administration mode which are Enable and Disable.

**Hold Time** - the legal time period of a received CDP packet.



**Transmit Interval** - the CDP packet sending interval.

**Port Authen. State** - the CDP administration mode for all ports which are Enable and Disable.

#### Command Buttons

**Submit** - Send the updated screen to the switch. Changes take effect on the switch but these changes will not be retained across a power cycle unless a save is performed.

CDP Configure

 Print
  Reload
  Help

Admin Mode

Hold Time (10 - 255)Sec

Transmit Interval (5 - 254)Sec

**Slot/Port**

All	<input type="text" value=""/>
0/1	<input type="text" value="Enable"/>
0/2	<input type="text" value="Enable"/>
0/3	<input type="text" value="Enable"/>
0/4	<input type="text" value="Enable"/>
0/5	<input type="text" value="Enable"/>
0/6	<input type="text" value="Enable"/>
0/7	<input type="text" value="Enable"/>
0/8	<input type="text" value="Enable"/>
0/9	<input type="text" value="Enable"/>
0/10	<input type="text" value="Enable"/>
0/11	<input type="text" value="Enable"/>
0/12	<input type="text" value="Enable"/>
0/13	<input type="text" value="Enable"/>
0/14	<input type="text" value="Enable"/>
0/15	<input type="text" value="Enable"/>
0/16	<input type="text" value="Enable"/>
0/17	<input type="text" value="Enable"/>
0/18	<input type="text" value="Enable"/>

### Viewing Neighbors Information Page

#### **Non-Configurable Data**



Use this menu to display CDP neighbors device information in the LAN.

#### **Command Buttons**

**Clear** - Clear all the counters, resetting all switch summary and detailed statistics to default values. The discarded packets count cannot be cleared.

**Refresh** - Refresh the data on the screen with the present state of the data in the switch.

Neighbors Information

 Print
  Reload
  Help

CDP Neighbors Information

Capability Codes : R - Router, T - Trans Bridge, B - Source Route Bridge  
S - Switch, H - Host, I - IGMP, r - Repeater, P - Phone

Device ID	Intf	Time	Capability	Platform	Port ID
SW1.2.32	3	169	R S I	Woven	49

### Viewing Traffic Statistics Page

Use this menu to display CDP traffic statistics.

#### Non-Configurable Data

**Incoming Packet Number** - Received legal CDP packets number from neighbors.

**Outgoing Packet Number** - Transmitted CDP packets number from this device.



**Error Packet Number** - Received illegal CDP packets number from neighbors.

#### Command Buttons

**Clear Counters** - Clear all the counters, resetting all switch summary and detailed statistics to default values. The discarded packets count cannot be cleared.

**Refresh** - Refresh the data on the screen with the present state of the data in the switch.

Traffic Statistics

 Print
  Reload
  Help

Incoming Packet Number	109
Outgoing Packet Number	109
Error Packet Number	0

## 11.2.1.10 Defining Trap Manager

### 11.2.1.10.1. Configuring Trap Flags Page

Use this menu to specify which traps you want to enable. When the condition identified by an active trap is encountered by the switch a trap message will be sent to any enabled SNMP Trap Receivers, and a message will be written to the trap log.

#### Configurable Data

**Authentication** - Enable or disable activation of authentication failure traps by selecting

the corresponding line on the pull down entry field. The factory default is enabled.

**Link Up/Down** - Enable or disable activation of link status traps by selecting the corresponding line on the pull down entry field. The factory default is enabled.

**Multiple Users** - Enable or disable activation of multiple user traps by selecting the corresponding line on the pull down entry field. The factory default is enabled. This trap is triggered when the same user ID is logged into the switch more than once at the same time (either via telnet or the serial port).

**Spanning Tree** - Enable or disable activation of spanning tree traps by selecting the corresponding line on the pull down entry field. The factory default is enabled.

**ACL Traps** - Enable or disable activation of ACL traps by selecting the corresponding line on the pulldown entry field. The factory default is disabled.

**DVMRP Traps** - Enabled or disable activation of DVMRP traps by selecting the corresponding line on the pulldown entry field. The factory default is disabled.

**OSPF Traps** - Enabled or disable activation of OSPF traps by selecting the corresponding line on the pulldown entry field. The factory default is disabled. This field can be configured only if the OSPF admin mode is enabled.

**PIM Traps** - Enabled or disable activation of PIM traps by selecting the corresponding line on the pulldown entry field. The factory default is disabled.

**OSPFv3 Traps** - Enabled or disable activation of OSPFv3 traps by selecting the corresponding line on the pulldown entry field. The factory default is disabled. This field can be configured only if the OSPFv3 admin mode is enabled.

### Command Buttons

**Submit** - Sends the updated screen to the switch and causes the changes to take effect on the switch. These changes will not be retained across a power cycle unless a save is performed.

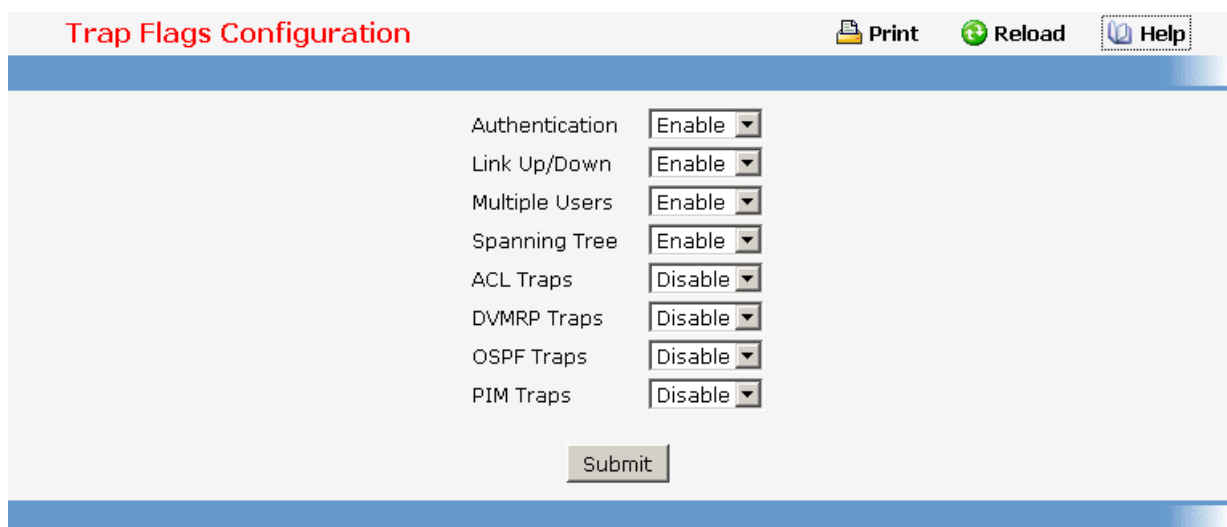

**Trap Flags Configuration** Print Reload Help

Authentication	Enable
Link Up/Down	Enable
Multiple Users	Enable
Spanning Tree	Enable
ACL Traps	Disable
DVMRP Traps	Disable
OSPF Traps	Disable
PIM Traps	Disable

### 11.2.1.10.2. Viewing Trap Log Page

This screen lists the entries in the trap log. The information can be retrieved as a file by using System Utilities, Upload File from Switch.

#### Non-Configurable Data

**Number of Traps since last reset** - The number of traps that have occurred since the switch were last reset.

**Trap Log Capacity** - The maximum number of traps stored in the log. If the number of traps exceeds the capacity, the entries will overwrite the oldest entries.

**Log** - The sequence number of this trap.



**System Up Time** - The time at which this trap occurred, expressed in days, hours, minutes and seconds since the last reboot of the switch.

**Trap** - Information identifying the trap.

#### Command Buttons

**Clear Log** - Clear all entries in the log. Subsequent displays of the log will only show new log entries.

Trap Log

 Print
 Reload
 Help

---

Number of Traps Since Last Reset		9
Trap Log Capacity		256
Number of Traps Since Log Last Viewed		9

Log	System Up Time	Trap
0	2008/01/08 14:02:11	Link Up: Unit: 1 Slot: 0 Port: 3
1	2008/01/08 14:02:11	Link Up: Unit: 1 Slot: 0 Port: 3
2	2008/01/08 14:02:01	Link Down: Unit: 1 Slot: 3 Port: 1
3	2008/01/08 14:02:01	Link Up: Unit: 1 Slot: 0 Port: 3
4	2008/01/08 14:02:01	Link Down: Unit: 1 Slot: 3 Port: 1
5	2008/01/08 14:02:01	Link Down: Unit: 1 Slot: 3 Port: 1
6	2008/01/08 14:02:01	Link Down: Unit: 1 Slot: 3 Port: 1
7	2008/01/08 12:15:28	Cold Start: Unit: 0
8	2008/01/08 12:15:08	Link Up: Unit: 1 Slot: 0 Port: 3



### 11.2.1.11 Configuring SNTP

#### 11.2.1.11.1. Configuring SNTP Global Configuration Page

##### Configurable Data

**Client Mode** - Specifies the mode of operation of SNTP Client. An SNTP client may operate in one of the following modes.

- **Disable**- SNTP is not operational. No SNTP requests are sent from the client nor are any received SNTP messages processed.
- **Unicast**- SNTP operates in a point to point fashion. A unicast client sends a request to a designated server at its unicast address and expects a reply from which it can determine the time and, optionally the round-trip delay and local clock offset relative to the server.
- **Broadcast** - SNTP operates in the same manner as multicast mode but uses a local broadcast address instead of a multicast address. The broadcast address has a single subnet scope while a multicast address has Internet wide scope.

Default value is Disable.

**Port** - Specifies the local UDP port to listen for responses/broadcasts. Allowed range is (1 to 65535). Default value is 123.

**Unicast Poll Interval** - Specifies the number of seconds between unicast poll requests expressed as a power of two when configured in unicast mode. Allowed range is (6 to 10). Default value is 6.

**Broadcast Poll Interval** - Specifies the number of seconds between broadcast poll requests expressed as a power of two when configured in broadcast mode. Broadcasts received prior to the expiry of this interval are discarded. Allowed range is (6 to 10). Default value is 6.



**Unicast Poll Timeout** - Specifies the number of seconds to wait for an SNTP response when configured in unicast mode. Allowed range is (1 to 30). Default value is 5.

**Unicast Poll Retry** - Specifies the number of times to retry a request to an SNTP server after the first time-out before attempting to use the next configured server when configured in unicast mode. Allowed range is (0 to 10). Default value is 1.

##### Command Buttons

**Submit** - Sends the updated configuration to the switch. Configuration changes take effect immediately.

SNTP Global Configuration

 Print
  Reload
  Help

---

Client Mode	<input type="text" value="Disable"/>	
Port	<input type="text" value="123"/>	(1 to 65535)
Unicast Poll Interval	<input type="text" value="6"/>	(6 to 10)
Broadcast Poll Interval	<input type="text" value="6"/>	(6 to 10)
Unicast Poll Timeout	<input type="text" value="5"/>	(1 to 30)
Unicast Poll Retry	<input type="text" value="1"/>	(0 to 10)

### 11.2.1.11.2. Viewing SNTP Global Status Page

#### Non-Configurable Data

**Version** - Specifies the SNTP Version the client supports.

**Supported Mode** - Specifies the SNTP modes the client supports. Multiple modes may be supported by a client.

**Last Update Time** - Specifies the local date and time (UTC) the SNTP client last updated the system clock.

**Last Attempt Time** - Specifies the local date and time (UTC) of the last SNTP request or receipt of an unsolicited message.

**Last Attempt Status** - Specifies the status of the last SNTP request or unsolicited message for both unicast and broadcast modes. If no message has been received from a server, a status of Other is displayed. These values are appropriate for all operational modes.

- **Other**None of the following enumeration values.
- **Success**The SNTP operation was successful and the system time was updated.
- **Request Timed Out**A directed SNTP request timed out without receiving a response from the SNTP server.
- **Bad Date Encoded**The time provided by the SNTP server is not valid.
- **Version Not Supported**TheSNTP version supported by the server is not compatible with the version supported by the client.
- **Server Unsynchronized**The SNTP server is not synchronized with its peers. This is indicated via the 'leap indicator' field on the SNTP message.
- **Server Kiss Of Death**The SNTP server indicated that no further queries were to be sent to this server. This is indicated by a stratum field equal to 0 in a message received from a server.

**Server IP Address** - Specifies the IP address of the server for the last received valid

packet. If no message has been received from any server, an empty string is shown.

**Address Type** - Specifies the address type of the SNTP Server address for the last received valid packet.

**Server Stratum** - Specifies the claimed stratum of the server for the last received valid packet.



**Reference Clock Id** - Specifies the reference clock identifier of the server for the last received valid packet.

**Server Mode** - Specifies the mode of the server for the last received valid packet.

**Unicast Sever Max Entries** - Specifies the maximum number of unicast server entries that can be configured on this client.

**Unicast Server Current Entries** - Specifies the number of current valid unicast server entries configured for this client.

**Broadcast Count** - Specifies the number of unsolicited broadcast SNTP messages that have been received and processed by the SNTP client since last reboot.

<b>SNTP Global Status</b>		 <b>Print</b>	 <b>Reload</b>	 <b>Help</b>
Version	4			
Supported Mode	Unicast & Broadcast			
Last Update Time	JAN 01 00:00:00 1970			
Last Attempt Time	JAN 01 00:00:00 1970			
Last Attempt Status	Other			
Server IP Address				
Address Type	Unknown			
Server Stratum	0 - Unspecified			
Reference Clock Id				
Server Mode	Reserved			
Unicast Server Max Entries	3			
Unicast Server Current Entries	0			
Broadcast Count	0			

### 11.2.1.11.3. Configuring SNTP Server Page

#### Configurable Data

**Server** - Specifies all the existing Server Addresses along with an additional option "Create". When the user selects "Create" another text box "Address" appears where the user may enter Address for Server to be configured.

**Address** - Specifies the address of the SNTP server. This is a text string of up to 64 characters containing the encoded unicast IP address or hostname of a SNTP server.

Unicast SNTP requests will be sent to this address. If this address is a DNS hostname, then that hostname should be resolved into an IP address each time a SNTP request is sent to it.

**Address Type** - Specifies the address type of the configured SNTP Server address. Allowed types are :

- **Unknown**
- **IPV4**
- **DNS**

Default value is Unknown

**Port** - Specifies the port on the server to which SNTP requests are to be sent. Allowed range is (1 to 65535). Default value is 123.

**Priority** - Specifies the priority of this server entry in determining the sequence of servers to which SNTP requests will be sent. The client continues sending requests to different servers until a successful response is received or all servers are exhausted. This object indicates the order in which to query the servers. A server entry with a precedence of 1 will be queried before a server with a priority of 2, and so forth. If more than one server has the same priority then the requesting order will follow the lexicographical ordering of the entries in this table. Allowed range is (1 to 3). Default value is 1.



**Version** - Specifies the NTP Version running on the server. Allowed range is (1 to 4). Default value is 4.

### Command Buttons

**Submit** - Sends the updated configuration to the switch. Configuration changes take effect immediately.

**Delete** - Deletes the SNTP Server entry. Sends the updated configuration to the switch. Configuration changes take effect immediately.

SNTP Server Configuration

 **Print**
 **Reload**
 **Help**

Server	<input type="button" value="Create"/>
Address	<input style="width: 100%;" type="text"/>
Address Type	<input type="button" value="IPv4"/>
Port	<input style="width: 50%;" type="text" value="123"/> (1 to 65535)
Priority	<input style="width: 50%;" type="text" value="1"/> (1 to 3)
Version	<input style="width: 50%;" type="text" value="4"/> (1 to 4)

#### 11.2.1.11.4. Viewing SNTP Server Status Page

##### Non-Configurable Data

**Address** - Specifies all the existing Server Addresses. If no Server configuration exists, a message saying "No SNTP server exists" flashes on the screen.

**Last Update Time** - Specifies the local date and time (UTC) that the response from this server was used to update the system clock.

**Last Attempt Time** - Specifies the local date and time (UTC) that this SNTP server was last queried.

**Last Attempt Status** - Specifies the status of the last SNTP request to this server. If no packet has been received from this server, a status of Other is displayed.

- **Other** None of the following enumeration values.
- **Success** The SNTP operation was successful and the system time was updated.
- **Request Timed Out** A directed SNTP request timed out without receiving a response from the SNTP server.
- **Bad Date Encoded** The time provided by the SNTP server is not valid.
- **Version Not Supported** The SNTP version supported by the server is not compatible with the version supported by the client.
- **Server Unsynchronized** The SNTP server is not synchronized with its peers. This is indicated via the 'leap indicator' field on the SNTP message.
- **Server Kiss Of Death** The SNTP server indicated that no further queries were to be sent to this server. This is indicated by a stratum field equal to 0 in a message received from a server.

**Unicast Server Num Requests** - Specifies the number of SNTP requests made to this server since last time agent reboot.

**Unicast Server Num Failed Requests** - Specifies the number of failed SNTP requests made to this server since last reboot.

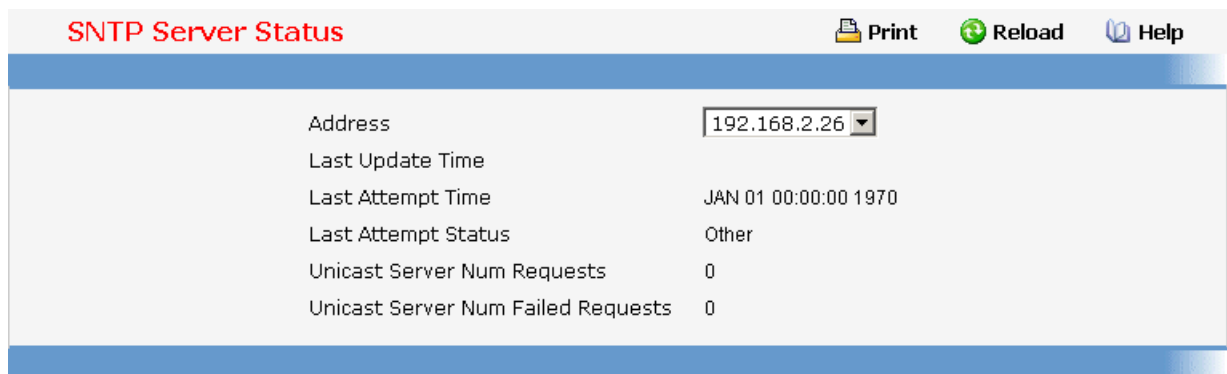

SNTP Server Status	
Address	192.168.2.26
Last Update Time	
Last Attempt Time	JAN 01 00:00:00 1970
Last Attempt Status	Other
Unicast Server Num Requests	0
Unicast Server Num Failed Requests	0

### 11.2.1.11.5. Configuring Current Time Settings Page

#### Configurable Data

**Year** - Year (4-digit). (Range: 2000 - 2099).

**Month** - Month. (Range: 1 - 12).

**Day** - Day of month. (Range: 1 - 31).

**Hour** - Hour in 24-hour format. (Range: 0 - 23).

**Minute** - Minute. (Range: 0 - 59).

**Second** - Second. (Range: 0 - 59).

#### Command Buttons

**Submit** - Send the updated screen to the switch. Changes take effect on the switch but these changes will not be retained across a power cycle unless a save is performed.

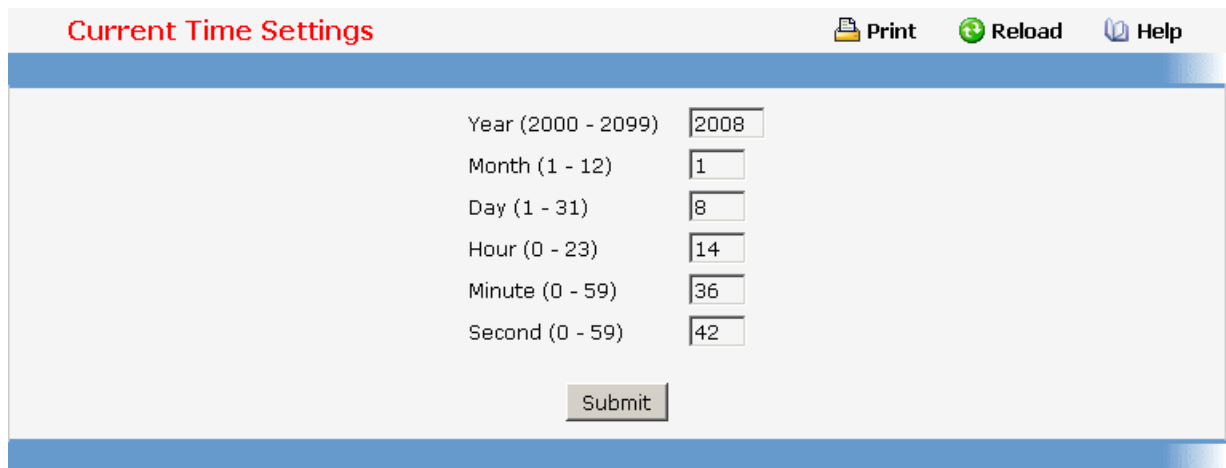

**Current Time Settings** Print Reload Help

Year (2000 - 2099)

Month (1 - 12)

Day (1 - 31)

Hour (0 - 23)

Minute (0 - 59)

Second (0 - 59)

### 11.2.1.11.6. Configuring Time Zone Settings Page

Simple Network Time Protocol (SNTP) allows the switch to set its internal clock based on periodic updates from a time server. Maintaining an accurate time on the switch enables the system log to record meaningful dates and times for event entries. You can also manually set the clock using the CLI. If the clock is not set, the switch will only record the time from the factory default set at the last bootup.

#### Configurable Data

**Time Zone Name** - The name of time zone, usually an acronym. (Range: 1-15 characters).

**Time Zone Hours** - The number of hours before/after UTC. (Range: 0-12 hours).

**Time Zone Minutes** - The number of minutes before/after UTC. (Range: 0-59 minutes).

- before-utc - Sets the local time zone before (east) of UTC
- after-utc - Sets the local time zone after (west) of UTC

**Command Buttons**

**Submit** - Send the updated screen to the switch. Changes take effect on the switch but these changes will not be retained across a power cycle unless a save is performed.

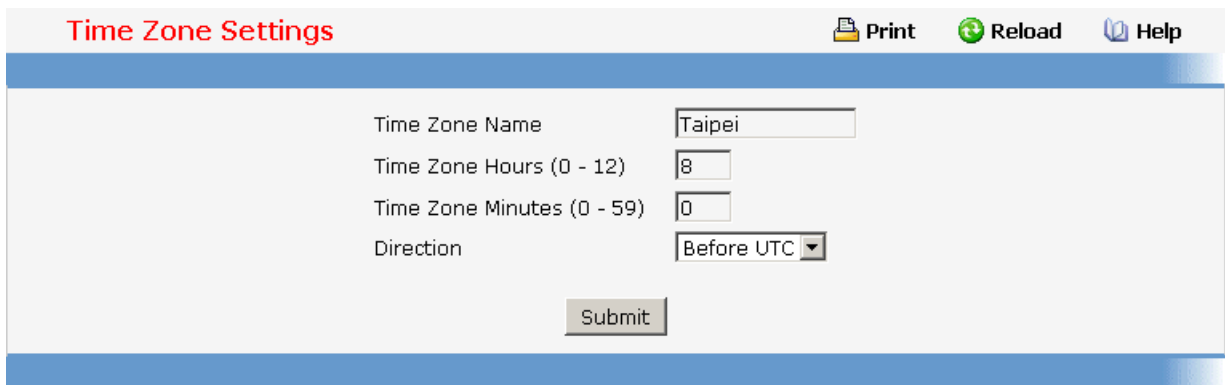

**11.2.1.12 Defining DHCP Client**

**11.2.1.12.1. Configuring DHCP Restart Page**

This command issues a BOOTP or DHCP client request for any IP interface that has been set to BOOTP or DHCP mode via the IP address command. DHCP requires the server to reassign the client's last address if available. If the BOOTP or DHCP server has been moved to a different domain, the network portion of the address provided to the client will be based on this new domain.

**Command Buttons**

**Reset** - Send the updated screen to the switch to restart the DHCP client.

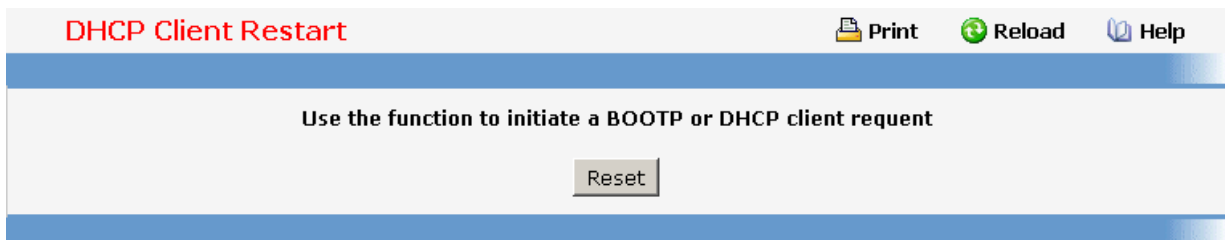

### 11.2.1.12.2. Configuring DHCP Client-identifier Page

Specify the DHCP client identifier for the switch. The DHCP client identifier is used to include a client identifier in all communications with the DHCP server. The identifier type depends on the requirements of your DHCP server.

#### Non-Configurable Data

**Current DHCP Identifier (Hex/Text)** - Shows the current setting of DHCP identifier.

#### Configurable Data

**DHCP Identifier** - Specifies the type of DHCP Identifier.

- **Default**
- **Specific Text String**
- **Specific Hexadecimal Value**

**Text String** - A text string.

**Hex Value** - The hexadecimal value.

#### Command Buttons

**Submit** - Send the updated screen to the switch perform the setting DHCP client identifier.

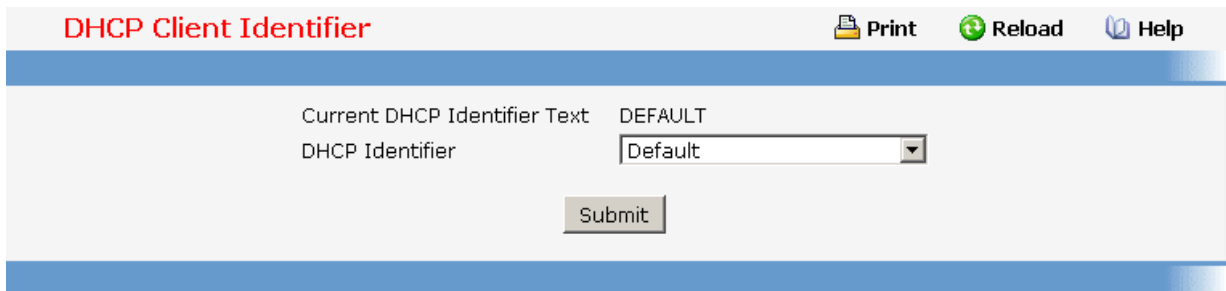

### 11.2.1.13 Defining sFlow Function

#### 11.2.1.13.1. Configuring Global Configuration Page

##### Configurable Data

**sFlow Rate** - This field is used to set SFlow rate. If the throughput larger than SFlow rate, the agent(client) will trigger an flow sample event and send a flow sample packet to collector(server). Allowed range is (1000 to 100000000). Default value is 0. 0 means no SFlow rate.

**sFlow Interval** - This field is used to set SFlow interval. It is a period timer, the agent will send counter sample packet to collector when timeup. Allowed range is (20 to 120). Default value is 0. 0 means no SFlow interval.

**sFlow Maximum-Header** - This field is used to set SFlow maximum-header. Flow sample content a packet which capture by BCM chip, and maximum header-size means the size we reference. If BCM chip capture packet is 64 bytes, but the maximum header-size is 36 bytes, then 36 bytes of this packet will be generate into the flow sample packet. Allowed range is (32 to 256). Default value is 128.



**sFlow Maximun-Datagram** - This filed is used to set SFlow maximum-datagram. Like maximum header-size, maximum datagram-size is the maximum size of UDP content (doesn't include UDP header and above). Allowed range is (500 to 1470). Default value is 1400.

**sFlow Collector-Address** - This filed is used to set SFlow collector IP address.

**sFlow Collector-Port** - This filed is used to set SFlow collector-port. Allowed range is (1025 to 65535). Default value is 6343.

### None Configurable Data

**Agent-Address** - This filed is used to display SFlow agent IP address.

### Command Buttons

**Submit** - Sends the updated configuration to the switch. Configuration changes take effect immediately.

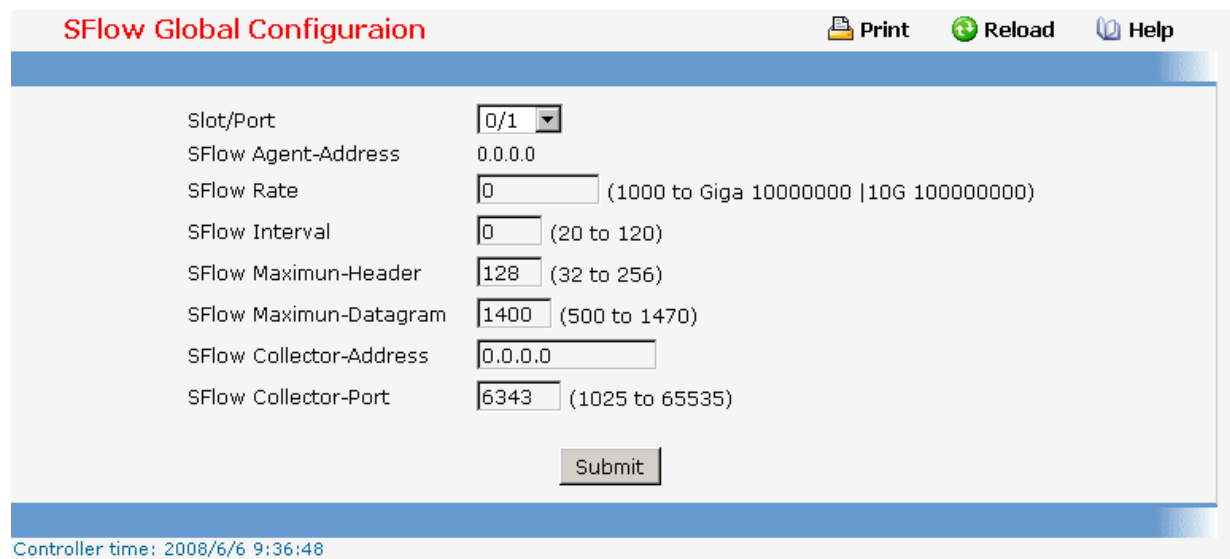

### 11.2.1.13.2. Configuring Global Status Page

#### Non-Configurable Data

**Agent-Address** - This filed is used to display SFlow agent IP address.

**Rate** - This filed is used to set SFlow rate.

**Interval** - This filed is used to set SFlow interval.

**Maximun-Header** - This filed is used to set SFlow maximum-header.

**Maximun-Datagram** - This filed is used to set SFlow maximum-datagram.

**Collector-Port** - This filed is used to set SFlow collector-port.

**Collector-Address** - This filed is used to set SFlow collector IP address.

SFlow Global Status						
Interface	Rate	Interval	Maximun-Header	Maximun-Datagram	Collector-Address	Collector-Port
0/1	0	0	128	1400	0.0.0.0	6343
0/2	0	0	128	1400	0.0.0.0	6343
0/3	0	0	128	1400	0.0.0.0	6343
0/4	0	0	128	1400	0.0.0.0	6343
0/5	0	0	128	1400	0.0.0.0	6343
0/6	0	0	128	1400	0.0.0.0	6343
0/7	0	0	128	1400	0.0.0.0	6343
0/8	0	0	128	1400	0.0.0.0	6343
0/9	0	0	128	1400	0.0.0.0	6343
0/10	0	0	128	1400	0.0.0.0	6343
0/11	0	0	128	1400	0.0.0.0	6343
0/12	0	0	128	1400	0.0.0.0	6343
0/13	0	0	128	1400	0.0.0.0	6343
0/14	0	0	128	1400	0.0.0.0	6343
0/15	0	0	128	1400	0.0.0.0	6343
0/16	0	0	128	1400	0.0.0.0	6343
0/17	0	0	128	1400	0.0.0.0	6343
0/18	0	0	128	1400	0.0.0.0	6343
0/19	0	0	128	1400	0.0.0.0	6343
0/20	0	0	128	1400	0.0.0.0	6343
0/21	0	0	128	1400	0.0.0.0	6343

## 11.2.2 Switching Menu

### 11.2.2.1 Managing DHCP Filtering

#### 11.2.2.1.1. Configuring DHCP Filtering Configuration Page

##### Configurable Data

**Admin Mode** - Enables or disables the DHCP Filtering feature.

##### Command Buttons

**Submit** - Applies the new configuration and causes the changes to take effect. These changes will not be retained across a power cycle unless a save configuration is performed.

DHCP Filtering Configuration	
Admin Mode	Disable
<input type="button" value="Submit"/>	

### 11.2.2.1.2. Configuring DHCP Filtering Interface Configuration Page

#### Selection Criteria

**Slot/Port** - Selects the interface for which data is to be displayed or configured.

#### Configurable Data



**Trust Mode** - Enables or disables DHCP Filtering on the selected interface.

#### Command Buttons

**Submit** - Applies the new configuration and causes the changes to take effect. These changes will not be retained across a power cycle unless a save configuration is performed.

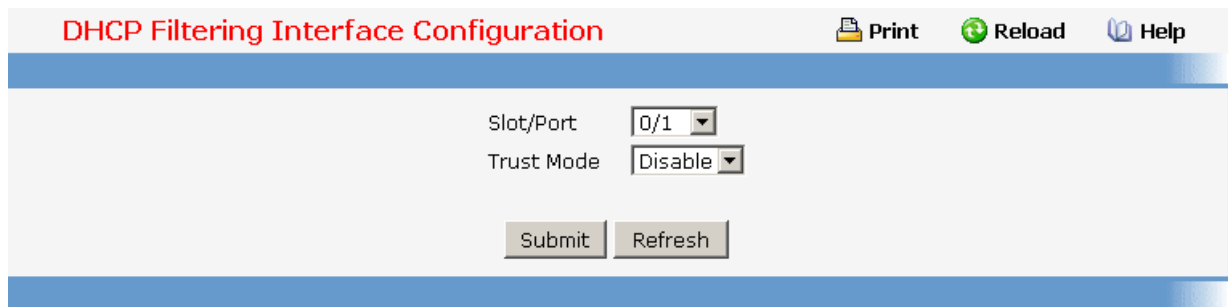
**Refresh** - Reload the page with the most current information.



DHCP Filtering Interface Configuration  Print  Reload  Help

Slot/Port

Trust Mode

### 11.2.2.1.3. Configuring DHCP Filtering Interface Summary Page

#### Non-configurable data

**Slot/Port** - The interface number.

**Trust Mode** - Displays the DHCP Filtering trust mode for the selected interface.

#### Command Buttons

**Refresh** - Reload the page with the most current information.

DHCP Filtering Interface Summary	
<b>Interface</b>	<b>Interface Trust Mode</b>
0/1	Disabled
0/2	Disabled
0/3	Disabled
0/4	Disabled
0/5	Disabled
0/6	Disabled
0/7	Disabled
0/8	Disabled
0/9	Disabled
0/10	Disabled
0/11	Disabled
0/12	Disabled
0/13	Disabled
0/14	Disabled
0/15	Disabled
0/16	Disabled
0/17	Disabled
0/18	Disabled
0/19	Disabled
0/20	Disabled
0/21	Disabled
0/22	Disabled
0/23	Disabled
0/24	Disabled

### 11.2.2.2 Managing Filters

#### 11.2.2.2.1. Configuring MAC filter Configuration Page

##### Non-Configurable Data

**MAC Filter** - This is the list of MAC address and VLAN ID pairings for all configured filters. To change the port mask(s) for an existing filter, select the entry you want to change. To add a new filter, select "Create Filter" from the top of the list.

##### Configurable Data

**MAC Address** - The MAC address of the filter in the format 00:01:1A:B2:53:4D. You can only change this field when you have selected the "Create Filter" option. You cannot define filters for these MAC addresses:

- 00:00:00:00:00:00
- 01:80:C2:00:00:00 to 01:80:C2:00:00:0F
- 01:80:C2:00:00:20 to 01:80:C2:00:00:21
- FF:FF:FF:FF:FF:FF

**VLAN ID** - The VLAN ID used with the MAC address to fully identify packets you want filtered. You can only change this field when you have selected the "Create Filter" option.

**Source Port Members** - List the ports you want included in the inbound filter. If a packet with the MAC address and VLAN ID you selected is received on a port that is not in the list, it will be dropped.

### Command Buttons

**Submit** - Update the switch with the values on the screen. If you want the switch to retain the new values across a power cycle you must perform a save.

**Delete** - Remove the currently selected filter.

**Delete All** - Remove all configured filters.

MAC Filter Configuration
Print
Reload
Help

---

**MAC Filter**

**MAC Address**

**VLAN ID**

**Source Port Mask**  

0/1  
0/2  
0/3  
0/4  
0/5  
0/6  
0/7  
0/8

### 11.2.2.2.2. MAC filter Summary Page

#### Non-Configurable Data

**MAC Address** - The MAC address of the filter in the format 00:01:1A:B2:53:4D.

**VLAN ID** - The VLAN ID associated with the filter.

**Source Port Members** - A list of ports to be used for filtering inbound packets.

MAC Filter Summary
Print
Reload
Help

---

MAC Address	VLAN ID	Source Port Members
00:11:22:33:44:55	1	[ 0/18 ]

### 11.2.2.3 Managing Port-based VLAN

### 11.2.2.3.1. Configuring Port-based VLAN Configuration Page

#### Selection Criteria

**VLAN ID and Name** - You can use this screen to reconfigure an existing VLAN, or to create a new one. Use this pull down menu to select one of the existing VLANs, or select 'Create' to add a new one.

#### Configurable Data

**VLAN ID** - Specify the VLAN Identifier for the new VLAN. (You can only enter data in this field when you are creating a new VLAN.) The range of the VLAN ID is (1 to 3965).

**VLAN Name** - Use this optional field to specify a name for the VLAN. It can be up to 32 alphanumeric characters, including blanks. The default is blank. VLAN ID 1 always has a name of 'Default'.

**VLAN Type** - This field identifies the type of the VLAN you are configuring. You cannot change the type of the default VLAN (VLAN ID = 1): it is always type 'Default'. When you create a VLAN, using this screen, its type will always be 'Static'. A VLAN that is created by GVRP registration initially has a type of 'Dynamic'. You may use this pull down menu to change its type to 'Static'.

**Participation** - Use this field to specify whether a port will participate in this VLAN. The factory default is 'Autodetect'. The possible values are:

- Include - This port is always a member of this VLAN. This is equivalent to registration fixed in the IEEE 802.1Q standard.
- Exclude - This port is never a member of this VLAN. This is equivalent to registration forbidden in the IEEE 802.1Q standard.
- Autodetect - Specifies that port may be dynamically registered in this VLAN via GVRP. The port will not participate in this VLAN unless it receives a GVRP request. This is equivalent to registration normal in the IEEE 802.1Q standard.

**Tagging** - Select the tagging behavior for this port in this VLAN. The factory default is 'Untagged'. The possible values are:

Tagged - all frames transmitted for this VLAN will be tagged.

Untagged - all frames transmitted for this VLAN will be untagged.

#### Non-Configurable Data

**Slot/Port** - Indicates which port is associated with the fields on this line.



**Status** - Indicates the current value of the participation parameter for the port.

#### Command Buttons

**Submit** - Update the switch with the values on this screen. If you want the switch to retain the new values across a power cycle, you must perform a save.

**Delete** - Delete this VLAN. You are not allowed to delete the default VLAN.

VLAN Configuration

 Print
  Reload
  Help

VLAN ID and Name 1 - Default ▼

VLAN ID 1

VLAN Name Default

VLAN Type Default

Slot/Port	Status	Participation	Tagging
All		▼	▼
0/1	Include	Include ▼	Untagged ▼
0/2	Include	Include ▼	Untagged ▼
0/3	Include	Include ▼	Untagged ▼
0/4	Include	Include ▼	Untagged ▼
0/5	Include	Include ▼	Untagged ▼
0/6	Include	Include ▼	Untagged ▼
0/7	Include	Include ▼	Untagged ▼
0/8	Include	Include ▼	Untagged ▼
0/9	Include	Include ▼	Untagged ▼
0/10	Include	Include ▼	Untagged ▼
0/11	Include	Include ▼	Untagged ▼
0/12	Include	Include ▼	Untagged ▼
0/13	Include	Include ▼	Untagged ▼

#### 11.2.2.3.2. Viewing Port-based VLAN Information Page

This page displays the status of all currently configured VLANs.

**VLAN ID** - The VLAN Identifier (VID) of the VLAN. The range of the VLAN ID is (1 to 3965).

**VLAN Name** - The name of the VLAN. VLAN ID 1 is always named `Default`.

**VLAN Type** - The VLAN type:

Default ( VLAN ID = 1) -- always present

Static -- a VLAN you have configured

Dynamic -- a VLAN created by GVRP registration that you have not converted to static, and that GVRP may therefore remove.

VLAN Status			
VLAN ID	VLAN Name	VLAN Type	Slot/Port
1	Default	Default	0/1, 0/2, 0/3, 0/4, 0/5, 0/6, 0/7, 0/8, 0/9, 0/10, 0/11, 0/12, 0/13, 0/14, 0/15, 0/16, 0/17, 0/18, 0/19, 0/20, 0/21, 0/22, 0/23, 0/24, 0/25, 0/26, 0/27, 0/28, 0/29, 0/30, 0/31, 0/32, 0/33, 0/34, 0/35, 0/36, 0/37, 0/38, 0/39, 0/40, 0/41, 0/42, 0/43, 0/44, 0/45, 0/46, 0/47, 0/48, 0/49, 0/50, 0/51, 0/52
1002	fddi-default	Static	
1003	token-ring-default	Static	
1004	fddinet-default	Static	
1005	trnet-default	Static	

### 11.2.2.3.3. Configuring VLAN Port Configuration Page

#### Selection Criteria

**Slot/Port** - Select the physical interface for which you want to display or configure data. Select 'All' to set the parameters for all ports to same values.

#### Configurable Data

**Port VLAN ID** - Specify the VLAN ID you want assigned to untagged or priority tagged frames received on this port. The factory default is 1.

**Acceptable Frame Types** - Specify how you want the port to handle untagged and priority tagged frames. If you select 'VLAN only', the port will discard any untagged or priority tagged frames it receives. If you select 'Admit All', untagged and priority tagged frames received on the port will be accepted and assigned the value of the Port VLAN ID for this port. Whichever you select, VLAN tagged frames will be forwarded in accordance with the IEEE 802.1Q VLAN standard. The factory default is 'Admit All'.

**Ingress Filtering** - Specify how you want the port to handle tagged frames. If you enable Ingress Filtering on the pull down menu, a tagged frame will be discarded if this port is not a member of the VLAN identified by the VLAN ID in the tag. If you select disable from the pull down menu, all tagged frames will be accepted. The factory default is disabled.



**Port Priority** - Specify the default 802.1p priority assigned to untagged packets arriving at the port.

#### Command Buttons

**Submit** - Update the switch with the values on this screen. If you want the switch to retain the new values across a power cycle, you must perform a save.



VLAN Port Configuration

 Print
  Reload
  Help

Slot/Port	<input type="text" value="All"/>
Port VLAN ID	<input type="text" value="1"/> (1 to 3965)
Acceptable Frame Types	<input type="text" value="Admit All"/>
Ingress Filtering	<input type="text" value="Disable"/>
Port Priority	<input type="text" value="0"/> (0 to 7)

#### 11.2.2.3.4. Viewing VLAN Port Summary Page

##### Non-Configurable Data

**Slot/Port** - The interface.

**Port VLAN ID** - The VLAN ID that this port will assign to untagged frames or priority tagged frames received on this port.

**Acceptable Frame Types** - Specifies the types of frames that may be received on this port. The options are 'VLAN only' and 'Admit All'. When set to 'VLAN only', untagged frames or priority tagged frames received on this port are discarded. When set to 'Admit All', untagged frames or priority tagged frames received on this port are accepted and assigned the value of the Port VLAN ID for this port. With either option, VLAN tagged frames are forwarded in accordance to the 802.1Q VLAN specification.

**Ingress Filtering** - When enabled, the frame is discarded if this port is not a member of the VLAN with which this frame is associated. In a tagged frame, the VLAN is identified by the VLAN ID in the tag. In an untagged frame, the VLAN is the Port VLAN ID specified for the port that received this frame. When disabled, all frames are forwarded in accordance with the 802.1Q VLAN bridge specification. The factory default is disabled.

**Port Priority** - Specifies the default 802.1p priority assigned to untagged packets arriving at the port.

VLAN Port Summary					
Listing of all Ports on the Switch					
Slot/Port	Port VLAN ID	Acceptable Frame Types	Ingress Filtering	Port Priority	
0/1	1	Admit All	Disabled	0	
0/2	1	Admit All	Disabled	0	
0/3	1	Admit All	Disabled	0	
0/4	1	Admit All	Disabled	0	
0/5	1	Admit All	Disabled	0	
0/6	1	Admit All	Disabled	0	
0/7	1	Admit All	Disabled	0	
0/8	1	Admit All	Disabled	0	
0/9	1	Admit All	Disabled	0	
0/10	1	Admit All	Disabled	0	
0/11	1	Admit All	Disabled	0	
0/12	1	Admit All	Disabled	0	
0/13	1	Admit All	Disabled	0	
0/14	1	Admit All	Disabled	0	
0/15	1	Admit All	Disabled	0	
0/16	1	Admit All	Disabled	0	
0/17	1	Admit All	Disabled	0	
0/18	1	Admit All	Disabled	0	
0/19	1	Admit All	Disabled	0	
0/20	1	Admit All	Disabled	0	
0/21	1	Admit All	Disabled	0	
0/22	1	Admit All	Disabled	0	
0/23	1	Admit All	Disabled	0	

### 11.2.2.3.5. Resetting VLAN Configuration Page

#### Command Buttons

**Reset** - If you select this button and confirm your selection on the next screen, all VLAN configuration parameters will be reset to their factory default values. Also, all VLANs, except for the default VLAN, will be deleted. The factory default values are:

- All ports are assigned to the default VLAN of 1.
- All ports are configured with a PVID of 1.
- All ports are configured to an Acceptable Frame Types value of Admit All Frames.
- All ports are configured with Ingress Filtering disabled.
- All ports are configured to transmit only untagged frames.
- GVRP is disabled on all ports and all dynamic entries are cleared.
- GVRP is disabled for the switch and all dynamic entries are cleared.
- GMRP is disabled on all ports and all dynamic entries are cleared.
- GMRP is disabled for the switch and all dynamic entries are cleared.

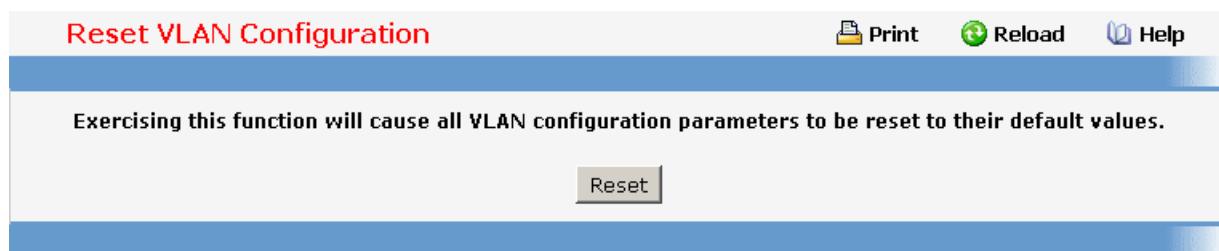

### 11.2.2.4 Managing Protected Ports

#### 11.2.2.4.1. Protected Ports Configuration Page

Use this menu to configure the ports as protected or unprotected. You need read-write access privileges to modify the configuration.

#### Selection Criteria

**Group ID** - The protected ports can be combined into a logical group. Traffic can flow between protected ports belonging to different groups, but not within the same group. The selection box lists all the possible protected port Group IDs supported for the current platform. The valid range of the Group ID is (0 to 2) .

#### Configurable Data

**Group Name** - It is a name associated with the protected ports group used for identification purposes. It can be up to 32 alphanumeric characters long, including blanks. The default is blank. This field is optional.

**Protected Ports** - The selection list consists of physical ports, protected as well as unprotected. The protected ports are highlighted to differentiate between them. No traffic forwarding is possible between two protected ports. If left unconfigured, the default state is unprotected.

#### Command Buttons

**Submit** - Update the switch with the values entered. For the switch to retain new values across a power cycle, a save operation is a must.

**Protected Ports Configuration** Print Reload Help

Group ID:

Group Name:

Protected Port(s):

#### 11.2.2.4.2. Protected Ports Summary Page

##### Non-Configurable Data

**Group ID** - The protected ports can be combined into a logical group. Traffic can flow between protected ports belonging to different groups, but not within the same group. The valid range of the Group ID is (0 to 2) .

**Group Name** - Displays the alphanumeric string associated with a Group ID.

**Protected Ports** - The display list consists of all the protected ports. It is to be noted that no traffic forwarding is possible between two protected ports of a same group, but traffic can flow between protected ports of different groups.

##### Command Buttons

**Refresh** - Refresh the data on the screen to obtain data on current state of the ports.

**Protected Ports Summary** Print Reload Help

Group ID	Group Name	Protected Port(s)
0	Hello	0/18
1		
2		

## 11.2.2.5 Managing Protocol-based VLAN

### 11.2.2.5.1. Protocol-based VLAN Configuration Page

You can use a protocol-based VLAN to define filtering criteria for untagged packets. By default, if you do not configure any port- (IEEE 802.1Q) or protocol-based VLANs, untagged packets will be assigned to VLAN 1. You can override this behavior by defining either port-based VLANs or protocol-based VLANs, or both. Tagged packets are always handled according to the IEEE 802.1Q standard, and are not included in protocol-based VLANs.

If you assign a port to a protocol-based VLAN for a specific protocol, untagged frames received on that port for that protocol will be assigned the protocol-based VLAN ID. Untagged frames received on the port for other protocols will be assigned the Port VLAN ID - either the default PVID (1) or a PVID you have specifically assigned to the port using the Port VLAN Configuration screen.

You define a protocol-based VLAN by creating a group. Each group has a one-to-one relationship with a VLAN ID, can include one to three protocol definitions, and can include multiple ports. When you create a group you will choose a name and a Group ID will be assigned automatically.

#### Selection Criteria

**Group ID** - You can use this screen to reconfigure or delete an existing protocol-based VLAN, or create a new one. Use this pull down menu to select one of the existing PBVLANs, or select 'Create' to add a new one. A Group ID number will be assigned automatically when you create a new group. You can create up to 128 groups.

#### Configurable Data

**Group Name** - Use this field to assign a name to a new group. You may enter up to 16 characters.

**Protocol(s)** - Select the protocols you want to be associated with the group. There are three configurable protocols: IP, IPX, and ARP. Hold down the control key to select more than one protocol.

**IP** - IP is a network layer protocol that provides a connectionless service for the delivery of data.

**ARP** - Address Resolution Protocol (ARP) is a low-level protocol that dynamically maps network layer addresses to physical medium access control (MAC) addresses

**IPX** - The Internetwork Packet Exchange (IPX) is a connectionless datagram Network-layer protocol that forwards data over a network.

**VLAN** - VLAN can be any number in the range of (1 to 3965) . All the ports in the group will assign this VLAN ID to untagged packets received for the protocols you included in this group.

**Slot/Port(s)** - Select the interface(s) you want to be included in the group. Note that a given interface can only belong to one group for a given protocol. If you have already added interface 0.1 to a group for IP, you cannot add it to another group that also includes IP, although you could add it to a new group for IPX.

#### Non-Configurable Data

**Group ID** - A number used to identify the group created by the user. Group IDs are automatically assigned when a group is created by the user.

#### Command Buttons

**Submit** - Update the switch with the values on this screen. If you want the switch to retain the new values across a power cycle, you must perform a save.

**Delete** - Remove the Protocol Based VLAN group identified by the value in the Group ID field. If you want the switch to retain the deletion across a power cycle, you must perform a save.

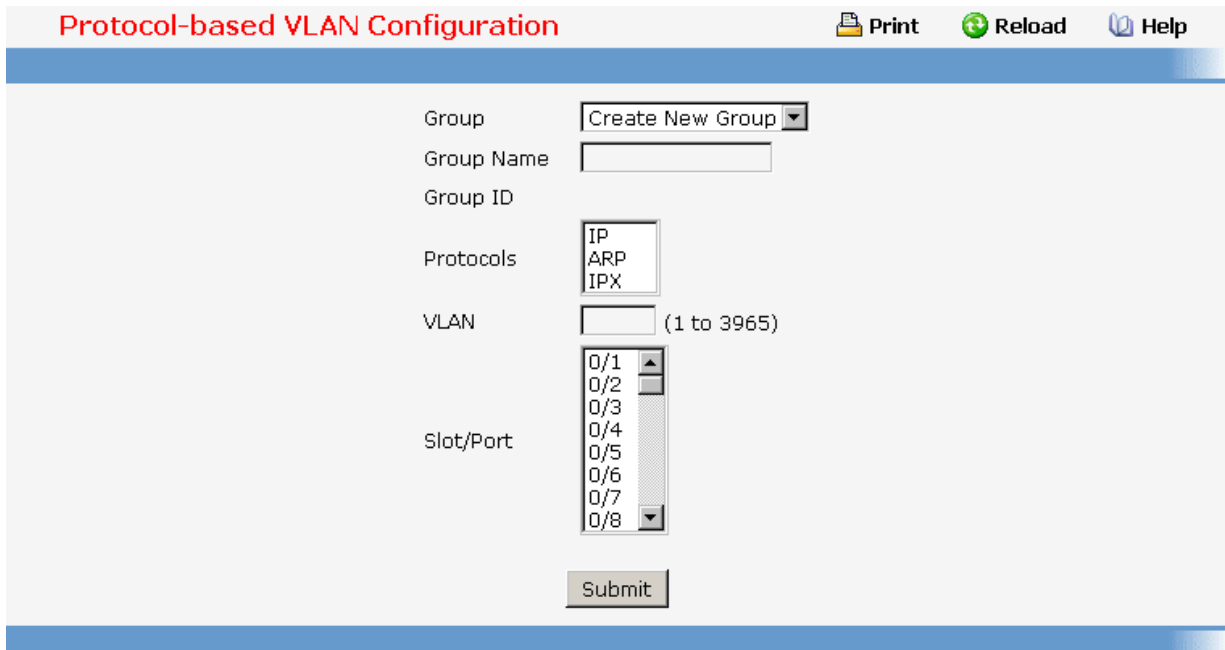

#### 11.2.2.5.2. Viewing Protocol-based VLAN Information Page

##### Non-Configurable Data

**Group Name** - The name associated with the group. Group names can be up to 16 characters. The maximum number of groups allowed is 128.

**Group ID** - The number used to identify the group. It was automatically assigned when you created the group.

**Protocol(s)** - The protocol(s) that belongs to the group. There are three configurable protocols: IP, IPX, and ARP.

**IP** - IP is a network layer protocol that provides a connectionless service for the delivery of data.

**ARP** - Address Resolution Protocol (ARP) is a low-level protocol that dynamically maps network layer addresses to physical medium access control (MAC) addresses.



**IPX** - The Internetwork Packet Exchange (IPX) is a connectionless datagram Network-layer protocol that forwards data over a network.

**VLAN** - The VLAN ID associated with the group.

**Slot/Port(s)** - The interfaces associated with the group.

##### Command Buttons

**Refresh** - Update the screen with the latest information.

Protocol-based VLAN Summary				
				 Print  Reload  Help
Group Name	Group ID	Protocols	VLAN	Slot/Port
1234	1	IPX	100	0/6, 0/7, 0/8
<input type="button" value="Refresh"/>				

### 11.2.2.6 Managing IP Subnet-based VLAN

#### 11.2.2.6.1. IP Subnet-based VLAN Configuration Page

IP Subnet to VLAN mapping is defined by configuring an entry in the IP Subnet to VLAN table. An entry is specified via a source IP address, network mask, and the desired VLAN ID. The IP Subnet to VLAN configurations are shared across all ports of the device.

#### Selection Criteria

**IP Address** - Selects the IP Address bound to a VLAN ID. To add another IP Subnet-based VLAN, select "Add" option.

#### Configurable Data

**IP Address** - Valid IP Address bound to VLAN ID. This field is configurable only when a new IP Subnet Based VLAN is being created. IP Address in dotted decimal notation.

**Subnet Mask** - Valid Subnet Mask of the IP Address. This field is configurable only when a new IP Subnet-based VLAN is being created. Subnet mask should be in dotted decimal notation.



**VLAN ID** - VLAN ID can be any number in the range of (1 to 3965).

#### Command Buttons

**Submit** - Update the switch with the values on this screen. If you want the switch to retain the new values across a power cycle, you must perform a save.

**Delete** - Delete an entry of IP Subnet to VLAN mapping.

IP Subnet-based VLAN Configuration

 Print
  Reload
  Help

IP Address

IP Address

Subnet Mask

VLAN ID  (1 to 3965)

### 11.2.2.6.2. Viewing IP Subnet-based VLAN Information Page

#### Non-Configurable Data

**IP Address** - The IP Address of the subnet that is being bound to a VLAN ID.



**Subnet Mask** - Subnet mask of the IP Address bound to VLAN ID.

**VLAN ID** - VLAN ID to which above mentioned IP Subnet is being bound to. VLAN ID can be any number in the range of (1 to 3965).

#### Command Buttons

**Refresh** - Update the screen with the latest information.

IP Subnet-based VLAN Summary

 Print
  Reload
  Help

IP Address	Subnet Mask	VLAN ID
192.168.2.26	255.255.255.0	100

### 11.2.2.7 Managing MAC-based VLAN

#### 11.2.2.7.1. MAC-based VLAN Configuration Page

MAC-based VLAN feature allows incoming untagged packets to be assigned to a VLAN and thus classify traffic based on the source MAC address of the packet.

A MAC to VLAN mapping is defined by configuring an entry in the MAC to VLAN table. An entry is specified via a source MAC address and the desired VLAN ID. The MAC to VLAN configurations are shared across all ports of the device (i.e. there is a system wide table that



has MAC address to VLAN ID mappings).

When untagged or priority tagged packets arrive at the switch and entries exist in the MAC to VLAN table, the source MAC address of the packet is looked up. If an entry is found the corresponding VLAN ID is assigned to the packet. If the packet is already priority tagged it will maintain this value, otherwise the priority will be set to zero. The assigned VLAN ID is verified against the VLAN table, if the VLAN is valid ingress processing on the packet continues, otherwise the packet is dropped. This implies that the user is allowed to configure a MAC address mapping to a VLAN that has not been created on the system.

### Configurable Data

**MAC Address** - Valid MAC Address which is to be bound to a VLAN ID. This field is configurable only when a MAC-based VLAN is created.

**VLAN ID** - VLAN ID can be any number in the range of (1 to 3965).

### Command Buttons

**Submit** - Update the switch with the values on this screen. If you want the switch to retain the new values across a power cycle, you must perform a save.

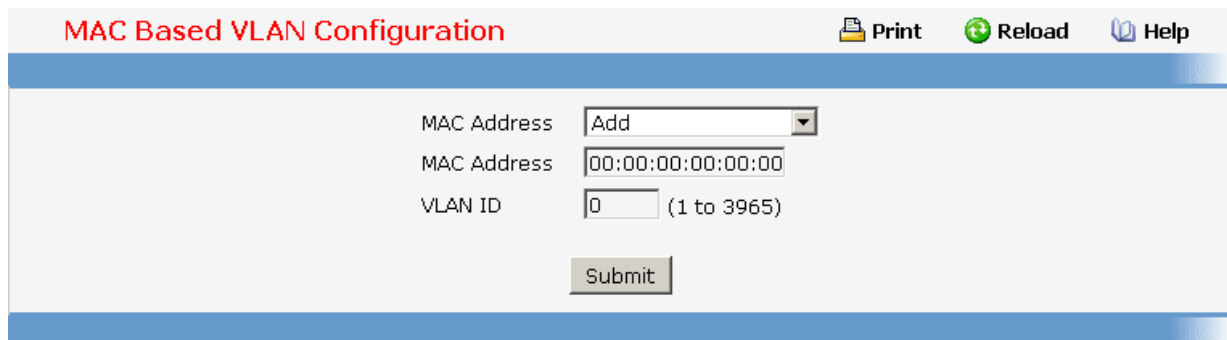

#### 11.2.2.7.2. Viewing MAC-based VLAN Information Page

### Non-Configurable Data



**MAC Address** - MAC Address bound to a VLAN ID.

**VLAN ID** - The VLAN ID to which a MAC Address is bound.

### Command Buttons

**Refresh** - Refresh the data on the screen with present state of data in the switch.

MAC-based VLAN Summary

 Print
  Reload
  Help

MAC Address	VLAN ID
00:11:22:33:44:55	1

### 11.2.2.8 Managing MAC-based Voice VLAN

#### 11.2.2.8.1. Voice VLAN Administration Page

##### Configurable Data



**VLAN ID** - Sets the VLAN as a Voice VLAN.

**Admin Mode** - Enables or disables the Voice VLAN function.

##### Command Buttons

**Submit** - Applies the new configuration and causes the changes to take effect. These changes will not be retained across a power cycle unless a save configuration is performed.

Voice VLAN Administration

 Print
  Reload
  Help

VLAN ID  (1 to 3965)

Admin Mode

#### 11.2.2.8.2. Voice VLAN Configuration Page

##### Selection Criteria

**MAC Address** - You can use this screen to create a new one. Use this pulldown menu to select one of the existing Voice VLANs, or select 'Create' to add a new one.

##### Configurable Data

**MAC Address** - Specify the MAC Address for the new Voice VLAN. (You can only enter data in this field when you are creating a new Voice VLAN.)

**MAC Address Mask** - Use this optional field to specify a mask for the Voice VLAN. The mac-mask is the last eight digit of the mask code of the MAC address, the valid values are: 0xff, 0xfe, 0xfc, 0xf8, 0xf0, 0xe0, 0xc0, 0x80 and 0x0.

**Voice-VLAN Priority** - This field identifies the priority of the Voice VLAN you are configuring. The priority-id is the priority of the voice traffic; the valid range is 0 to 7.

**Voice VLAN Name** - Use this field to specify the name of the voice device. It is to help the



device management.

### Command Buttons

**Submit** - Update the switch with the values on this screen. If you want the switch to retain the new values across a power cycle, you must perform a save.

**Delete** - Delete this VLAN. You are not allowed to delete the default VLAN.

Voice VLAN Configuration

 Print
  Reload
  Help

---

MAC Address

MAC Address

MAC Address Mask  (valid value: 255/254/252/248/240/224/192/128/0)

Voice-VLAN Priority  (0 to 7)

Voice VLAN Name

#### 11.2.2.8.3. Viewing Voice VLAN Information Page

This page displays the status of all currently configured Voice VLANs.

#### Non-Configurable Data



**Voice-VLAN Name** - The name of the voice device.

**MAC Address** - The MAC Address for the new Voice VLAN.

**MAC Address Mask** - The MAC Address Mask for the Voice VLAN. The value is the last eight digit of the mask code of the MAC address.

**Voice-VLAN Priority** - The priority-id is the priority of the voice traffic.

Voice VLAN Summary

 Print
  Reload
  Help

---

Voice-VLAN Name	MAC Address	MAC Address Mask	Voice-VLAN Priority
Voice VLAN1	11:22:33:44:55:66	255	3

#### 11.2.2.9 Managing Voice VLAN

### 11.2.2.9.1. Voice VLAN Configuration Page

Use this menu to configure the parameters for Voice VLAN Configuration. Note that only a user with Read/Write access privileges may change the data on this screen.

#### Configurable Data

**Voice VLAN Admin Mode** - Select the administrative mode for Voice VLAN for the switch from the pulldown menu. The default is disable.

**Unit/Slot/Port** - Select the physical interface for which you want to configure data.

**Voice VLAN Interface Mode** - Select the Voice VLAN mode for selected interface.

**Disable** - Default value

**None** - Allow the IP phone to use its own configuration to send untagged voice traffic

**VLAN ID** - Enter the Voice Vlan Id

**dot1p** - Configure Voice Vlan 802.1p priority tagging for voice traffic.

**Untagged** - Configure the phone to send untagged voice traffic.

**CoS Override Mode** - Select the Cos Override mode for selected interface. The default is disable.

#### Non-Configurable Data

**Operational State** - This is the operational status of the voice vlan on the given interface.

#### Command Buttons

**Submit** - Update the switch with the values you entered. If you want the switch to retain the new values across a power cycle you must perform a save. You will only see this button if you have Read/Write access privileges.

**Refresh** - Reload the contents of the configuration page.

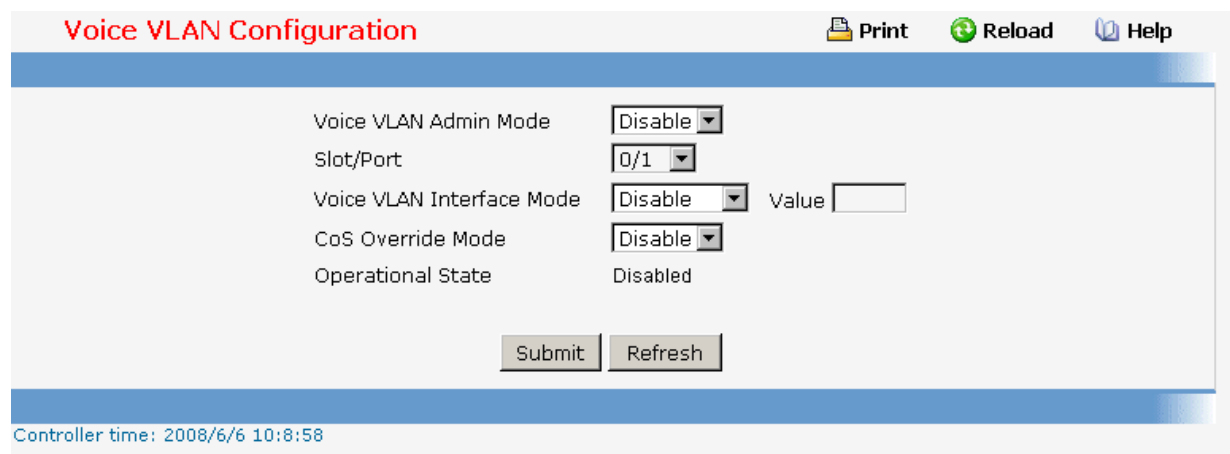

**Voice VLAN Configuration** Print Reload Help

Voice VLAN Admin Mode:

Slot/Port:

Voice VLAN Interface Mode:  Value:

CoS Override Mode:

Operational State: Disabled

Controller time: 2008/6/6 10:8:58

### 11.2.2.10 Defining GARP

### 11.2.2.10.1. Viewing GARP Information Page

This screen shows the GARP Status for the switch and for the individual ports. Note that the timers are only relevant when the status for a port shows as enabled.

#### Non-Configurable Data

**Switch GVRP** - Indicates whether the GARP VLAN Registration Protocol administrative mode for this switch is enabled or disabled. The factory default is disabled.

**Switch GMRP** - Indicates whether the GARP Multicast Registration Protocol administrative mode for this switch, enabled or disabled. The factory default is disabled.

**Slot/Port** - Slot/Port of the interface.



**Port GVRP Mode** - Indicates whether the GVRP administrative mode for the port is enabled or disabled. The factory default is disabled.

**Port GMRP Mode** - Indicates whether the GMRP administrative mode for the port is enabled or disabled. The factory default is disabled.

**Join Time (centiseconds)** - Specifies the time between the transmission of GARP PDUs registering (or re-registering) membership for a VLAN or multicast group in centiseconds. An instance of this timer exists for each GARP participant for each port. Permissible values are 10 to 100 centiseconds (0.1 to 1.0 seconds). The factory default is 20 centiseconds (0.2 seconds).

**Leave Time (centiseconds)** - Specifies the time to wait after receiving an unregister request for a VLAN or multicast group before deleting the associated entry, in centiseconds. This allows time for another station to assert registration for the same attribute in order to maintain uninterrupted service. An instance of this timer exists for each GARP participant for each port. Permissible values are 20 to 600 centiseconds (0.2 to 6.0 seconds). The factory default is 60 centiseconds (0.6 seconds).

**Leave All Time (centiseconds)** -This Leave All Time controls how frequently LeaveAll PDUs are generated. A LeaveAll PDU indicates that all registrations will shortly be deregistered. Participants will need to rejoin in order to maintain registration. An instance of this timer exists for each GARP participant for each port. The Leave All Period Timer is set to a random value in the range of LeaveAllTime to 1.5\*LeaveAllTime. Permissible values are 200 to 6000 centiseconds (2 to 60 seconds). The factory default is 1000 centiseconds (10 seconds).

<b>GARP Status</b>					
		 <b>Print</b>  <b>Reload</b>  <b>Help</b>			
Switch GVRP		Disabled			
Switch GMRP		Disabled			
Slot/Port	Port GVRP Mode	Port GMRP Mode	Join Timer (centiseecs)	Leave Timer (centiseecs)	Leave All Timer (centiseecs)
0/1	Disabled	Disabled	20	60	1000
0/2	Disabled	Disabled	20	60	1000
0/3	Disabled	Disabled	20	60	1000
0/4	Disabled	Disabled	20	60	1000
0/5	Disabled	Disabled	20	60	1000
0/6	Disabled	Disabled	20	60	1000
0/7	Disabled	Disabled	20	60	1000
0/8	Disabled	Disabled	20	60	1000
0/9	Disabled	Disabled	20	60	1000
0/10	Disabled	Disabled	20	60	1000
0/11	Disabled	Disabled	20	60	1000
0/12	Disabled	Disabled	20	60	1000
0/13	Disabled	Disabled	20	60	1000
0/14	Disabled	Disabled	20	60	1000
0/15	Disabled	Disabled	20	60	1000
0/16	Disabled	Disabled	20	60	1000
0/17	Disabled	Disabled	20	60	1000

### 11.2.2.10.2. Configuring the whole Switch GARP Configuration Page

**Note:** It can take up to 10 seconds for GARP configuration changes to take effect.

#### Configurable Data

**GVRP Mode** - Choose the GARP VLAN Registration Protocol administrative mode for the switch by selecting enable or disable from the pull down menu. The factory default is disabled.

**GMRP Mode** - Choose the GARP Multicast Registration Protocol administrative mode for the switch by selecting enable or disable from the pull down menu. The factory default is disabled.

#### Command Buttons

**Submit** - Update the switch with the values you entered. If you want the switch to retain the new values across a power cycle you must perform a save.

GARP Switch Configuration

 Print
  Reload
  Help

GVRP Mode	Disable ▾
GMRP Mode	Disable ▾

### 11.2.2.10.3. Configuring each Port GARP Configuration Page

**Note:** It can take up to 10 seconds for GARP configuration changes to take effect.

#### Selection Criteria

**Slot/Port** - Select the physical interface for which data is to be displayed or configured. It is possible to set the parameters for all ports by selecting 'All'.

#### Configurable Data

**Port GVRP Mode** - Choose the GARP VLAN Registration Protocol administrative mode for the port by selecting enable or disable from the pull down menu. If you select disable, the protocol will not be active and the Join Time, Leave Time, and Leave All Time will have no effect. The factory default is disabled.

**Port GMRP Mode** - Choose the GARP Multicast Registration Protocol administrative mode for the port by selecting enable or disable from the pull down menu. If you select disable, the protocol will not be active, and Join Time, Leave Time, and Leave All Time have no effect. The factory default is disabled.

**Join Time (centiseconds)** - Specify the time between the transmission of GARP PDUs registering (or re-registering) membership for a VLAN or multicast group in centiseconds. Enter a number between 10 and 100 (0.1 to 1.0 seconds). The factory default is 20 centiseconds (0.2 seconds). An instance of this timer exists for each GARP participant for each port.



**Leave Time (centiseconds)** - Specify the time to wait after receiving an unregister request for a VLAN or multicast group before deleting the associated entry, in centiseconds. This allows time for another station to assert registration for the same attribute in order to maintain uninterrupted service. Enter a number between 20 and 600 (0.2 to 6.0 seconds). The factory default is 60 centiseconds (0.6 seconds). An instance of this timer exists for each GARP participant for each port.

**Leave All Time (centiseconds)** - The Leave All Time controls how frequently LeaveAll PDUs are generated. A LeaveAll PDU indicates that all registrations will shortly be deregistered. Participants will need to rejoin in order to maintain registration. The Leave All Period Timer is set to a random value in the range of LeaveAllTime to 1.5\*LeaveAllTime. The timer is specified in centiseconds. Enter a number between 200 and 6000 (2 to 60 seconds). The factory default is 1000 centiseconds (10 seconds). An instance of this timer exists for each GARP participant for each port.

#### Command Buttons

**Submit** - Update the switch with the values you entered. If you want the switch to retain the new values across a power cycle you must perform a save.

**GARP Port Configuration**

 **Print**
 **Reload**
 **Help**

---

Slot/Port	All
Port GVRP Mode	Disable
Port GMRP Mode	Disable

**GARP Timers**

Join Timer (centiseocs)	20 (10 to 100)
Leave Timer (centiseocs)	60 (20 to 600)
Leave All Timer (centiseocs)	1000 (200 to 6000)

### 11.2.2.11 Managing IGMP Snooping

#### 11.2.2.11.1. Configuring IGMP Snooping Global Configuration Page

Use this menu to configure the parameters for IGMP Snooping, which is used to build forwarding lists for multicast traffic. Note that only a user with Read/Write access privileges may change the data on this screen.

#### Configurable Data

**Admin Mode** - Select the administrative mode for IGMP Snooping for the switch from the pulldown menu. The default is disable.

#### Non-Configurable Data

**Multicast Control Frame Count** - The number of multicast control frames that are processed by the CPU.

**Interfaces Enabled for IGMP Snooping** - A list of all the interfaces currently enabled for IGMP Snooping.

**Data Frames Forwarded by the CPU** - The number of data frames forwarded by the CPU.

**VLAN Ids Enabled For IGMP Snooping** - Displays VLAN Ids enabled for IGMP snooping.

#### Command Buttons



**Submit** - Update the switch with the values you entered. If you want the switch to retain the new values across a power cycle you must perform a save. You will only see this button if you have Read/Write access privileges.

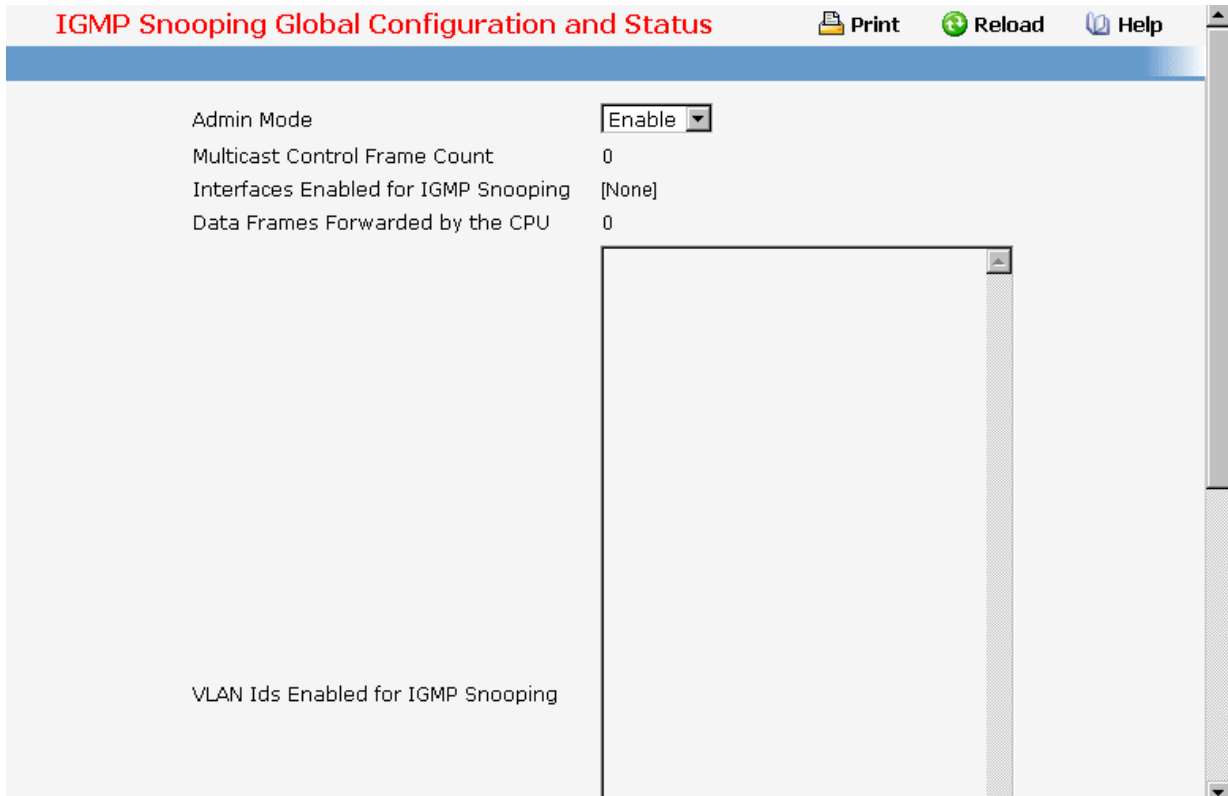

**IGMP Snooping Global Configuration and Status** Print Reload Help

Admin Mode	Enable
Multicast Control Frame Count	0
Interfaces Enabled for IGMP Snooping	[None]
Data Frames Forwarded by the CPU	0

VLAN Ids Enabled for IGMP Snooping

#### 11.2.2.11.2. Defining IGMP Snooping Interface Configuration Page

##### Configurable Data

**Slot/Port** - The single select box lists all physical ,VLAN and LAG interfaces. Select the interface you want to configure.

**Admin Mode** - Select the interface mode for the selected interface for IGMP Snooping for the switch from the pulldown menu. The default is disable.

**Group Membership Interval** - Specify the amount of time you want the switch to wait for a report for a particular group on a particular interface before it deletes that interface from the group. Enter a value between 1 and 3600 seconds. The default is 260 seconds.

**Max Response Time** - Specify the amount of time you want the switch to wait after sending a query on an interface because it did not receive a report for a particular group on that interface. Enter a value greater or equal to 1 and less than the Group Membership Interval in seconds. The default is 10 seconds. The configured value must be less than the Group Membership Interval.

**Multicast Router Present Expiration Time** - Specify the amount of time you want the switch to wait to receive a query on an interface before removing it from the list of interfaces with multicast routers attached. Enter a value between 0 and 3600 seconds. The default is 0 seconds. A value of zero indicates an infinite timeout, i.e. no expiration.

**Fast Leave Admin mode** - Select the Fast Leave mode for the a particular interface from the pulldown menu. The default is disable.

### Command Buttons

**Submit** - Update the switch with the values you entered. If you want the switch to retain the new values across a power cycle you must perform a save. You will only see this button if you have Read/Write access privileges.

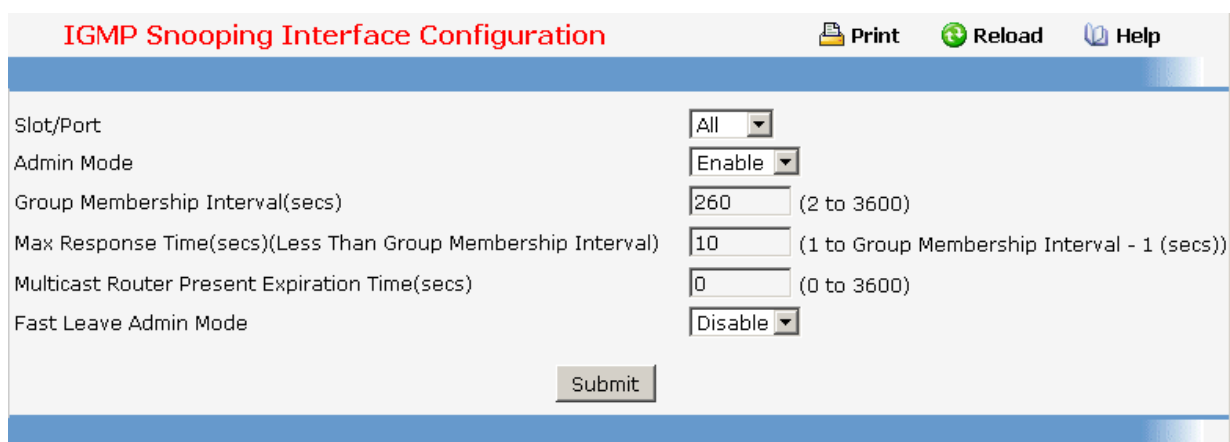

**IGMP Snooping Interface Configuration** Print Reload Help

Slot/Port	All	
Admin Mode	Enable	
Group Membership Interval(secs)	260	(2 to 3600)
Max Response Time(secs)(Less Than Group Membership Interval)	10	(1 to Group Membership Interval - 1 (secs))
Multicast Router Present Expiration Time(secs)	0	(0 to 3600)
Fast Leave Admin Mode	Disable	

### 11.2.2.11.3. Viewing IGMP Snooping VLAN Status Page

#### Non-Configurable Data

**VLAN ID** - All Vlan Ids for which the IGMP Snooping mode is Enabled.

**Admin Mode** - Igmp Snooping Mode for Vlan ID.

**Fast Leave Admin Mode** - Fast Leave Mode for Vlan ID.

**Group Membership Interval** - Group Membership Interval of IGMP Snooping for the specified VLAN ID. Valid range is 2 to 3600.

**Maximum Response Time** - Maximum Response Time of IGMP Snooping for the specified VLAN ID. Valid range is 1 to 3599. Its value should be greater than group membership interval value.

**Multicast Router Expiry Time** - Multicast Router Expiry Time of IGMP Snooping for the specified VLAN ID. Valid range is 0 to 3600.

#### Configurable Data

**Refresh** - Re-fetch the database and display it again starting with the first entry in the table.

IGMP Snooping VLAN Status					
VLAN ID	Admin Mode	Fast Leave Admin Mode	Group Membership Interval	Max Response Time	Multicast Router Expiry Time
2	Enable	Disable	260	10	1

Refresh

#### 11.2.2.11.4. Configuring IGMP Snooping VLAN Page

##### Configurable Data

**VLAN ID** - Specifies list of VLAN IDs for which IGMP Snooping is enabled.

**VLAN ID** - Appears when "New Entry" is selected in VLAN ID combo box. Specifies VLAN ID for which pre-configurable Snooping parameters are to be set.

**Admin Mode** - Enable or disable the Igmp Snooping for the specified VLAN ID.

**Fast Leave Admin Mode** - Enable or disable the Igmp Snooping Fast Leave Mode for the specified VLAN ID.

**Group Membership Interval** - Sets the value for group membership interval of IGMP Snooping for the specified VLAN ID. Valid range is (Maximum Response Time + 1) to 3600.



**Maximum Response Time** - Sets the value for maximum response time of IGMP Snooping for the specified VLAN ID. Valid range is 1 to (Group Membership Interval - 1). Its value should be greater than group membership interval value.

**Multicast Router Expiry Time** - Sets the value for multicast router expiry time of IGMP Snooping for the specified VLAN ID. Valid range is 0 to 3600.

##### Command Buttons

**Submit** - Update the switch with the values you entered.

IGMP Snooping VLAN Configuration

 Print
  Reload
  Help

VLAN ID	<input type="text" value="New Entry"/>	
VLAN ID	<input type="text" value=""/>	(1 to 3965)
Admin Mode	<input type="text" value="Enable"/>	
Fast Leave Admin Mode	<input type="text" value="Disable"/>	
Group Membership Interval	<input type="text" value="260"/>	(Max Response Time + 1 to 3600)
Maximum Response Time	<input type="text" value="10"/>	(1 to Group Membership Interval - 1)
Multicast Router Expiry Time	<input type="text" value="0"/>	(0 to 3600)
<input type="button" value="Submit"/> <input type="button" value="Delete"/>		

### 11.2.2.11.5. Viewing Multicast Router Statistics Page

#### Non-Configurable Data

**Slot/Port** - The single select box lists all physical and LAG interfaces. Select the interface for which you want to display the statistics.

**Multicast Router** - Specifies for the selected interface whether multicast router is enable or disabled.

#### Command Buttons

**Refresh** - Refetch the database and display it again starting with the first entry in the table.

Multicast Router Statistics	
Interface	Multicast Router
0/1	Disabled
0/2	Disabled
0/3	Disabled
0/4	Disabled
0/5	Disabled
0/6	Disabled
0/7	Disabled
0/8	Disabled
0/9	Disabled
0/10	Disabled
0/11	Disabled
0/12	Disabled
0/13	Disabled
0/14	Disabled
0/15	Disabled
0/16	Disabled
0/17	Disabled
0/18	Disabled
0/19	Disabled
0/20	Disabled

### 11.2.2.11.6. Configuring Multicast Router Page

#### Configurable Data

**Slot/Port** - The select box lists all Slot/Ports. Select the interface for which you want Multicast Router to be enabled .

**Multicast Router** - Enable or disable Multicast Router on the selected Slot/Port.

#### Command Buttons

**Submit** - Update the switch with the values you entered.

Multicast Router Configuration	
Slot/Port	0/1
Multicast Router	Disable
Submit	

### 11.2.2.11.7. Viewing Multicast Router VLAN Statistics Page

#### Selection Criteria

**Slot/Port** - The select box lists all Slot/Ports. Select the interface for which you want to display the statistics.

**Non-Configurable Data**

**VLAN ID** - All Vlan Ids for which the Multicast Router Mode is Enabled

**Multicast Router** - Multicast Router Mode for Vlan ID.

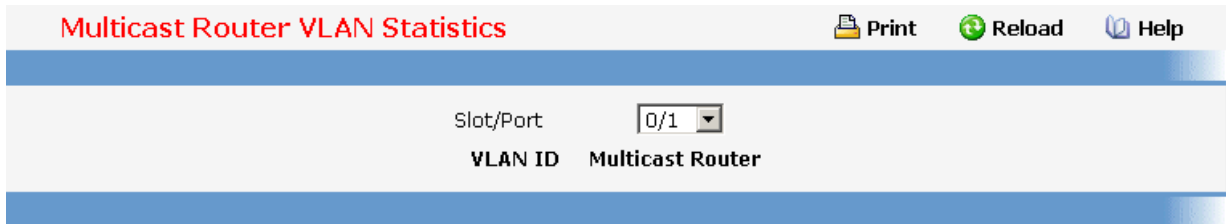

The screenshot shows the 'Multicast Router VLAN Statistics' page. At the top, there are three icons: 'Print', 'Reload', and 'Help'. Below the title bar, there is a 'Slot/Port' dropdown menu set to '0/1'. Underneath, there are two columns: 'VLAN ID' and 'Multicast Router'. The table area below is currently empty.

**11.2.2.11.8. Configuring Multicast Router VLAN Page**

**Selection Criteria**

**Slot/Port** - The select box lists all Slot/Ports. Select the interface for which you want Multicast Router to be enabled.

**Configurable Data**

**VLAN ID** - VLAN ID for which the Multicast Router Mode is to be Enabled or Disabled.

**Multicast Router** - For the Vlan ID, multicast router may be enabled or disabled using this.

**Command Buttons**

**Submit** - Update the switch with the values you entered.

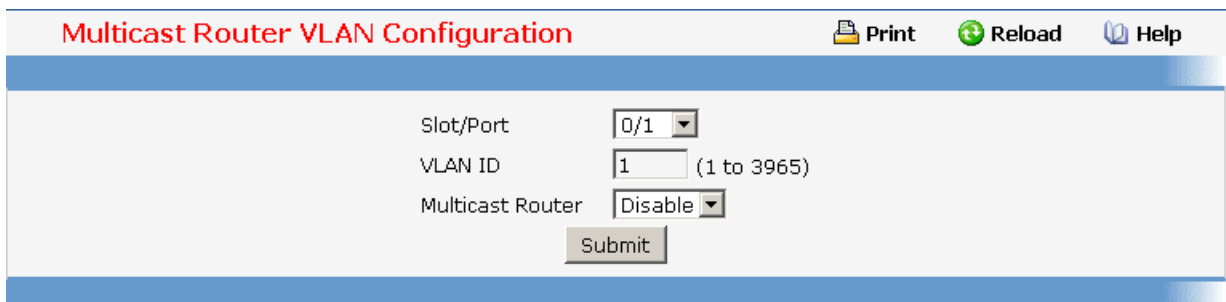

The screenshot shows the 'Multicast Router VLAN Configuration' page. At the top, there are three icons: 'Print', 'Reload', and 'Help'. Below the title bar, there are three configuration fields: 'Slot/Port' (dropdown menu set to '0/1'), 'VLAN ID' (text input field with '1' and '(1 to 3965)' next to it), and 'Multicast Router' (dropdown menu set to 'Disable'). Below these fields is a 'Submit' button.

**11.2.2.11.9. Configuring L2 Static Multicast Group Configuration Page**

**Non-Configurable Data**

**MAC Filter** - This is the list of MAC address and VLAN ID pairings for all configured L2Mcast Groups. To change the port mask(s) for an existing L2Mcast Group, select the entry you want to change. To add a new L2Mcast Group, select "Create Filter" from the top of the list.

### Configurable Data

**MAC Address** - The MAC address of the L2Mcast Group in the format 01:00:5E:xx:xx:xx. You can only change this field when you have selected the "**Create Filter**" option. You cannot define L2Mcast Group for these MAC addresses:

00:00:00:00:00:00

01:00:5E:00:00:01 to 01:00:5E:00:00:FF

FF:FF:FF:FF:FF:FF

**VLAN ID** - The VLAN ID used with the MAC address to fully identify packets you want L2Mcast Group. You can only change this field when you have selected the "Create Filter" option.

**Slot/Port(s)** - List the ports you want included into L2Mcast Group.

### Command Buttons

**Submit** - Update the switch with the values on the screen. If you want the switch to retain the new values across a power cycle you must perform a save.

**Delete** - Remove the currently selected L2Mcast Group.

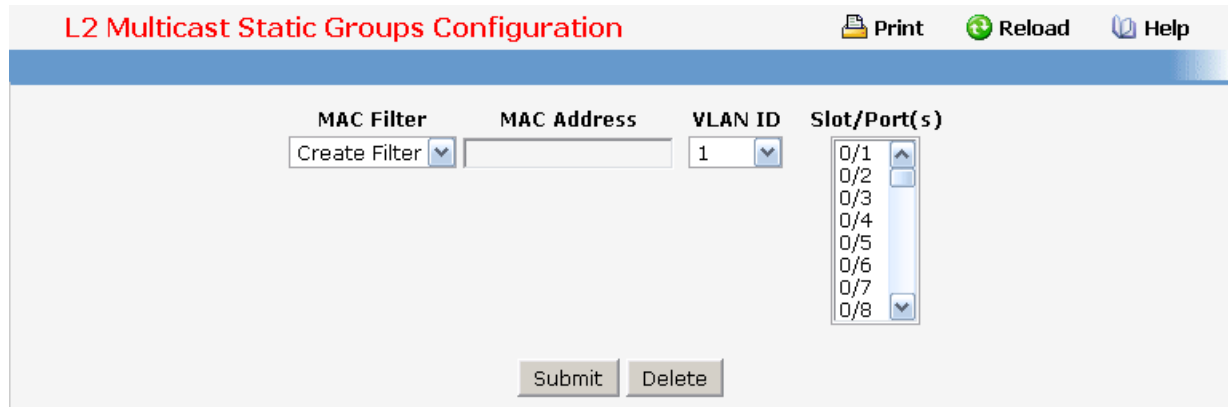

### 11.2.2.11.10. Viewing L2 Multicast Group Status Page

Use this panel to display information about entries in the L2Mcast Static/Dynamic Groups. These entries are used by the transparent bridging function to determine how to forward a received frame.

### Non-Configurable Data

**VLAN** - L2Mcast Group's VLAN ID value.



**MAC Address** - A multicast MAC address for which the switch has forwarding information. The format is a six-byte MAC address. For example: 01:00:5E:00:11:11.

**Slot/Ports** - the interface number belongs to this Multicast Group.

**Active State** - The active interface number belongs to this Multicast Group.

## Command Buttons

**Refresh** - Refresh the database and display it again starting with the first entry in the table.

L2 Multicast Static Groups Status			
			 Print  Reload  Help
VLAN	MAC Address	Slot/Port(s)	Active State
1	01:00:5e:12:53:76	0/25, 0/26, 0/27, 0/29	0/25, 0/26, 0/27, 0/29
<input type="button" value="Refresh"/>			

## 11.2.2.12 Managing IGMP Snooping Querier

### 11.2.2.12.1. Configuring IGMP Snooping Querier Configuration Page

Use this menu to configure the parameters for IGMP Snooping Querier, Note that only a user with Read/Write access privileges may change the data on this screen.

#### Configurable Data

**Snooping Querier Admin Mode** - Select the administrative mode for IGMP Snooping for the switch from the pulldown menu. The default is disable.

**Snooping Querier Address** - Specify the Snooping Querier Address to be used as source address in periodic IGMP queries. This address is used when no address is configured on the VLAN on which query is being sent.

**IGMP Version** - Specify the IGMP protocol version used in periodic IGMP queries. IGMP queries.

**Query Interval** - Specify the time interval in seconds between periodic queries sent by the snooping querier. The Query Interval must be a value in the range of 1 and 1800. The default value is 60.

**Querier Expiry Interval** - Specify the time interval in seconds after which the last querier information is removed. The Querier Expiry Interval must be a value in the range of 60 and 300. The default value is 60.



#### Command Buttons

**Submit** - Update the switch with the configured values.

**Refresh** - Reload the information on the page.



**IGMP Snooping Querier Configuration**

 **Print**
 **Reload**
 **Help**

Snooping Querier Admin Mode	<input type="text" value="Disable"/>
Snooping Querier Address	<input type="text" value="0.0.0.0"/>
IGMP Version	<input type="text" value="2"/> (1 to 2)
Query Interval(secs)	<input type="text" value="60"/> (1 to 1800)
Querier Expiry Interval(secs)	<input type="text" value="60"/> (60 to 300)

Controller time: 2008/6/9 5:2:40

### 11.2.2.12.2. Configuring IGMP Snooping Querier VLAN Configuration Page

#### Selection Criteria

**VLAN ID** - Selects the VLAN ID on which IGMP Snooping Querier is enabled.

#### Configurable Data

**VLAN ID** - Appears when "New Entry" is selected in VLAN ID selection list. Specifies VLAN ID for which IGMP Snooping Querier is to be enabled. User can also set pre-configurable Snooping Querier parameters.

**Querier Election Participate Mode** - Enable or disable the Igmp Snooping Querier participate in election mode. When this mode is disabled, up on seeing other querier of same version in the vlan, the snooping querier move to non querier state. Only when this mode is enabled, the snooping querier will participate in querier election where in the least ip address will win the querier election and operates as the querier in that VLAN. The other querier moves to non-querier state.

**Snooping Querier VLAN Address** - Specify the Snooping Querier Address to be used as source address in periodic IGMP queries sent on the specified VLAN



#### Configurable Data

**Submit** - Update the switch with the configured values.

**Delete** - To disable Snooping Querier on the selected VLAN. This button is not visible when a VLAN is not selected.

**Refresh** - Reload the information on the page.

IGMP Snooping Querier VLAN Configuration

 Print
  Reload
  Help

VLAN ID	<input type="text" value="New Entry"/>	
VLAN ID	<input type="text"/>	(1 to 3965)
Querier Election Participate Mode	<input type="text" value="Disable"/>	
Snooping Querier VLAN Address	<input type="text"/>	
<input type="button" value="Submit"/> <input type="button" value="Refresh"/>		

Controller time: 2008/6/9 5:11:26

### 11.2.2.12.3. IGMP Snooping Querier VLAN Configuration Summary Page

#### Configurable Data

**VLAN ID Search-** Enter VLAN ID, then click on the search button. If the record exists, that entry will be displayed. An exact match is required.

#### Non-Configurable Data

**Admin Mode** - Display the administrative mode for IGMP Snooping for the switch.

**VLAN ID Search-** Enter VLAN ID, then click on the search button. If the record exists, that entry will be displayed. An exact match is required.

**Querier Election Participate Mode** - Displays the querier election participate mode on the VLAN. When this mode is disabled, up on seeing a query of the same version in the vlan, the snooping querier move to non querier state. Only when this mode is enabled, the snooping querier will participate in querier election where in the least ip address will win the querier election and operates as the querier in that VLAN. The other querier moves to non-querier state.



**Snooping Querier VLAN Address** - Displays the Snooping Querier Address to be used as source address in periodic IGMP queries sent on the specified VLAN.

#### Command Buttons

**Search** - Search for the specified Vlan ID.

**Refresh** - Reload the information on the page.

**IGMP Snooping Querier VLAN Configuration Summary**

 **Print**
 **Reload**
 **Help**

---

VLAN ID Search

VLAN ID	Admin Mode	Querier Election Participate Mode	Snooping Querier VLAN Address
3	Disable	Enable	3.3.3.2

#### 11.2.2.12.4. IGMP Snooping Querier VLAN Status Page

##### Non-Configurable Data

**VLAN ID** - Specifies the VLAN ID on which IGMP Snooping Querier is administratively enabled and VLAN exists in the VLAN database.

**Operational State** - Specifies the operational state of the IGMP Snooping Querier on a VLAN. It can be in any of the following states:

**Querier** - Snooping switch is the Querier in the VLAN. The Snooping switch will send out periodic queries with a time interval equal to the configured querier query interval. If the snooping switch sees a better querier in the VLAN, it moves to non-querier mode.

**Non-Querier** - Snooping switch is in Non-Querier mode in the VLAN. If the querier expiry interval timer expires, the snooping switch will move into querier mode.

**Disabled** - Snooping Querier is not operational on the VLAN. The Snooping Querier moves to disabled mode when IGMP Snooping is not operational on the VLAN or when the querier address is not configured or the network management address is also not configured.

**Operational Version** - Displays the operational IGMP protocol version of the querier.

**Last Querier Address** - Displays the IP address of the last querier from which a query was snooped on the VLAN.

**Last Querier Version** - Displays the IGMP protocol version of the last querier from which a query was snooped on the VLAN.

**Operational Max Response Time** - Displays maximum response time to be used in the queries that are sent by the Snooping Querier.

##### Command Buttons

**Refresh** - Reload the information on the page.

IGMP Snooping Querier VLAN Status					
VLAN ID	Operational State	Operational Version	Last Querier Address	Last Querier Version	Operational Max Response Time (secs)
1	Querier	2			10

Refresh

### 11.2.2.13 Managing MLD Snooping

#### 11.2.2.13.1. Configuring MLD Snooping Global Configuration and Status Page

Use this menu to configure the parameters for MLD Snooping, which is used to build forwarding lists for multicast traffic. Note that only a user with Read/Write access privileges may change the data on this screen.

#### Configurable Data

**Admin Mode** - Select the administrative mode for MLD Snooping for the switch from the pulldown menu. The default is disable.

#### Non-Configurable Data

**Multicast Control Frame Count** - The number of multicast control frames that are processed by the CPU.

**Interfaces Enabled for MLD Snooping** - A list of all the interfaces currently enabled for MLD Snooping.



**Data Frames Forwarded by the CPU** - The number of data frames forwarded by the CPU.

**VLAN Ids Enabled For MLD Snooping** - Displays VLAN Ids enabled for MLD snooping.

#### Command Buttons

**Submit** - Update the switch with the values you entered. If you want the switch to retain the new values across a power cycle you must perform a save. You will only see this button if you have Read/Write access privileges.

MLD Snooping Global Configuration and Status

 Print
  Reload
  Help

Admin Mode	<input type="text" value="Disable"/>
Multicast Control Frame Count	0
Interfaces Enabled for MLD Snooping	[None]
Data Frames Forwarded by the CPU	0

VLAN Ids Enabled for MLD Snooping

### 11.2.2.13.2. Configuring MLD Snooping Interface Configuration Page

#### Configurable Data

**Slot/Port** - The single select box lists all physical ,VLAN and LAG interfaces. Select the interface you want to configure.

**Admin Mode** - Select the interface mode for the selected interface for MLD Snooping for the switch from the pulldown menu. The default is disable.

**Group Membership Interval** - Specify the amount of time you want the switch to wait for

a report for a particular group on a particular interface before it deletes that interface from the group. The valid range is from (2 to 3600) seconds. The configured value must be greater than Max Response Time. The default is 260 seconds.

**Max Response Time** - Specify the amount of time you want the switch to wait after sending a query on an interface because it did not receive a report for a particular group on that interface. Enter a value greater or equal to 1 and less than the Group Membership Interval in seconds. The default is 10 seconds. The configured value must be less than the Group Membership Interval.



**Multicast Router Present Expiration Time** - Specify the amount of time you want the switch to wait to receive a query on an interface before removing it from the list of interfaces with multicast routers attached. Enter a value between 0 and 3600 seconds. The default is 0 seconds. A value of zero indicates an infinite timeout, i.e. no expiration.

**Fast Leave Admin mode** - Select the Fast Leave mode for the a particular interface from the pulldown menu. The default is disable.

### Command Buttons

**Submit** - Update the switch with the values you entered. If you want the switch to retain the new values across a power cycle you must perform a save. You will only see this button if you have Read/Write access privileges.

MLD Snooping Interface Configuration

 Print
  Reload
  Help

---

Slot/Port	All <input type="button" value="v"/>
Admin Mode	Disable <input type="button" value="v"/>
Group Membership Interval(secs)	<input type="text" value="260"/> (2 to 3600)
Max Response Time(secs)(Less Than Group Membership Interval)	<input type="text" value="10"/> (1 to Group Membership Interval - 1 (secs))
Multicast Router Present Expiration Time(secs)	<input type="text" value="0"/> (0 to 3600)
Fast Leave Admin Mode	Disable <input type="button" value="v"/>

---

Controller time: 2008/6/9 5:39:36

### 11.2.2.13.3. Configuring MLD Snooping VLAN Status Page

#### Non-Configurable Data

**VLAN ID** - All Vlan Ids for which the MLD Snooping mode is Enabled.

**Admin Mode** - MLD Snooping Mode for Vlan ID.

**Fast Leave Admin Mode** - Fast Leave Mode for Vlan ID.

**Group Membership Interval** - Group Membership Interval of MLD Snooping for the specified VLAN ID. Valid range is 2 to 3600.

**Maximum Response Time** - Maximum Response Time of MLD Snooping for the specified VLAN ID. Valid range is 1 to 3599. Its value should be greater than group membership interval value.

**Multicast Router Expiry Time** - Multicast Router Expiry Time of MLD Snooping for the specified VLAN ID. Valid range is 0 to 3600.

### Command Buttons

**Refresh** - Re-fetch the database and display it again starting with the first entry in the table.

MLD Snooping VLAN Status					
VLAN ID	Admin Mode	Fast Leave Admin Mode	Group Membership Interval (secs)	Max Response Time (secs)	Multicast Router Expiry Time (secs)
Controller time: 2008/6/9 5:46:24					

### 11.2.2.13.4. Configuring MLD Snooping VLAN Configuration Page

#### Configurable Data

**VLAN ID** - Specifies list of VLAN IDs for which MLD Snooping is enabled.

**VLAN ID** - Appears when "New Entry" is selected in VLAN ID combo box. Specifies VLAN ID for which pre-configurable Snooping parameters are to be set.

**Fast Leave Admin Mode** - Enable or disable the MLD Snooping Fast Leave Mode for the specified VLAN ID.

**Group Membership Interval** - Sets the value for group membership interval of MLD Snooping for the specified VLAN ID. Valid range is (Maximum Response Time + 1) to 3600.

**Maximum Response Time** - Sets the value for maximum response time of MLD Snooping for the specified VLAN ID. Valid range is 1 to (Group Membership Interval - 1). Its value should be less than group membership interval value.

**Multicast Router Expiry Time** - Sets the value for multicast router expiry time of MLD Snooping for the specified VLAN ID. Valid range is 0 to 3600.

#### None-Configurable Data

**Admin Mode** - Enable MLD Snooping for the specified VLAN ID.

**Command Buttons**

**Submit** - Update the switch with the values you entered.

**Delete** - Update the switch with the default values.

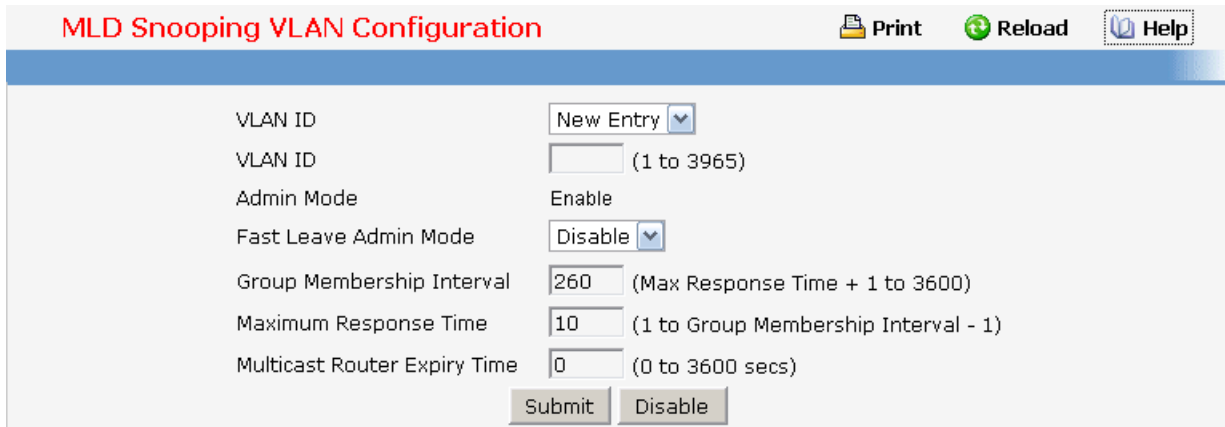

The screenshot shows the 'MLD Snooping VLAN Configuration' page. At the top right, there are buttons for 'Print', 'Reload', and 'Help'. The main configuration area includes the following fields:

- VLAN ID: New Entry (dropdown)
- VLAN ID: (input field) (1 to 3965)
- Admin Mode: Enable
- Fast Leave Admin Mode: Disable (dropdown)
- Group Membership Interval: 260 (Max Response Time + 1 to 3600)
- Maximum Response Time: 10 (1 to Group Membership Interval - 1)
- Multicast Router Expiry Time: 0 (0 to 3600 secs)

At the bottom of the configuration area, there are 'Submit' and 'Disable' buttons.

**11.2.2.13.5. Configuring Multicast Router Status Page**

**Non-Configurable Data**

**Slot/Port** - The single select box lists all physical and LAG interfaces. Select the interface for which you want to display the status.

**Multicast Router** - Specifies for the selected interface whether multicast router is enable or disabled.

**Command Buttons**

**Refresh** - Re-fetch the database and display it again starting with the first entry in the table.

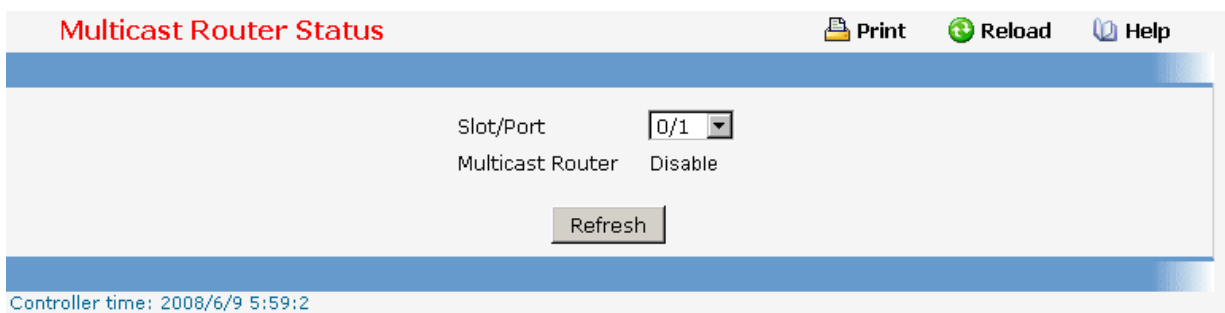

The screenshot shows the 'Multicast Router Status' page. At the top right, there are buttons for 'Print', 'Reload', and 'Help'. The main status area includes the following fields:

- Slot/Port: 0/1 (dropdown)
- Multicast Router: Disable

At the bottom of the status area, there is a 'Refresh' button. At the very bottom of the page, it says 'Controller time: 2008/6/9 5:59:2'.

**11.2.2.13.6. Configuring Multicast Router Status Page**

**Configurable Data**

**Slot/Port** - The select box lists all Slot/Ports. Select the interface for which you want



Multicast Router to be enabled.

**Multicast Router** - Enable or disable Multicast Router on the selected Slot/Port.

**Command Buttons**

**Submit** - Update the switch with the values you entered.

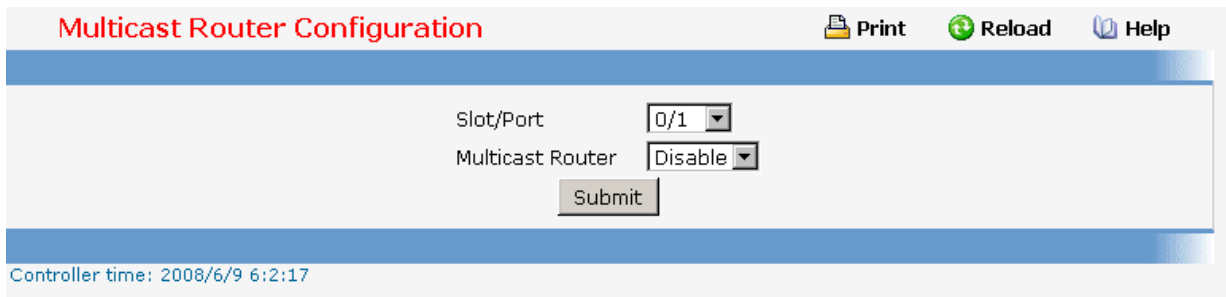

The screenshot shows a web interface titled "Multicast Router Configuration". At the top right, there are icons for "Print", "Reload", and "Help". The main content area contains two dropdown menus: "Slot/Port" with "0/1" selected and "Multicast Router" with "Disable" selected. Below these is a "Submit" button. At the bottom left, it says "Controller time: 2008/6/9 6:2:17".

**11.2.2.13.7. Configuring Multicast Router VLAN Status Page**

**Selection Criteria**

**Slot/Port** - The select box lists all Slot/Ports. Select the interface for which you want to display the status.

**Non-Configurable Data**

**VLAN ID** - All Vlan Ids for which the Multicast Router Mode is Enabled

**Multicast Router** - Multicast Router Mode for Vlan ID

**Command Buttons**

**Refresh** - Re-fetch the database and display it again starting with the first entry in the table.

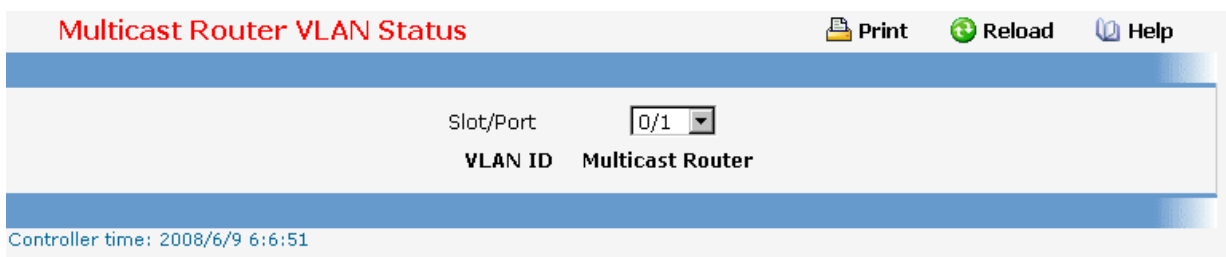

The screenshot shows a web interface titled "Multicast Router VLAN Status". At the top right, there are icons for "Print", "Reload", and "Help". The main content area contains a "Slot/Port" dropdown menu with "0/1" selected. Below it, there are two columns: "VLAN ID" and "Multicast Router". At the bottom left, it says "Controller time: 2008/6/9 6:6:51".

**11.2.2.13.8. Configuring Multicast VLAN Configuration Page**

**Selection Criteria**

**Slot/Port** - The select box lists all Slot/Ports. Select the interface for which you want Multicast Router to be enabled

### Configurable Data

**VLAN ID** - VLAN ID for which the Multicast Router Mode is to be Enabled or Disabled.

**Multicast Router** - For the Vlan ID, multicast router may be enabled or disabled using this.

### Command Buttons

**Submit** - Update the switch with the values you entered.

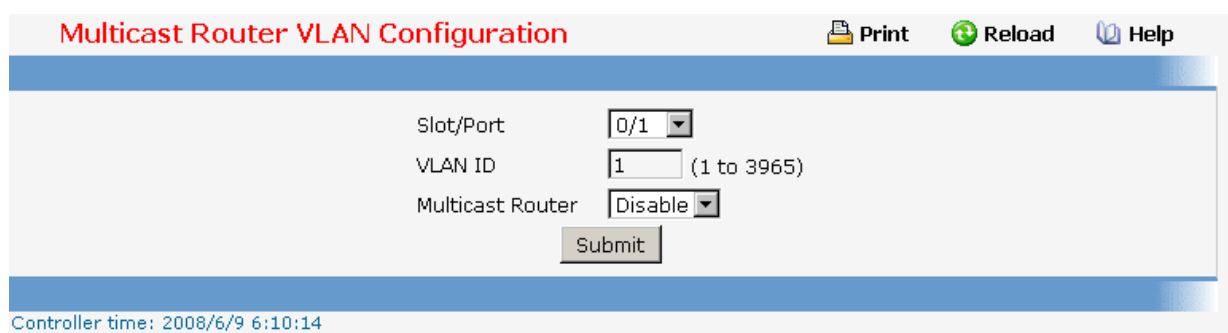

## 11.2.2.13.9. Configuring L2 Static Multicast Group Configuration Page

### Non-Configurable Data

**MAC Filter** - This is the list of MAC address and VLAN ID pairings for all configured L2 Mcast Groups. To change the port mask(s) for an existing L2Mcast Group, select the entry you want to change. To add a new L2Mcast Group, select "Create Filter" from the top of the list.

### Configurable Data

**MAC Address** - The MAC address of the L2Mcast Group in the format 01:00:5E:xx:xx:xx. You can only change this field when you have selected the "Create Filter" option.

You cannot define L2Mcast Group for these MAC addresses:

00:00:00:00:00:00

33:33:00:00:00:01 to 33:33:00:00:00:FF

FF:FF:FF:FF:FF:FF

**VLAN ID** - The VLAN ID used with the MAC address to fully identify packets you want L2Mcast Group. You can only change this field when you have selected the "Create Filter" option.



**Solt/Port(s)** - List the ports you want included into L2Mcast Group.

### Command Buttons

**Submit** - Update the switch with the values on the screen. If you want the switch to retain the new values across a power cycle you must perform a save.

**Delete** - Remove the currently selected L2Mcast Group.

L2 Multicast Static Groups Configuration

 Print
  Reload
  Help

MAC Filter	MAC Address	VLAN ID	Slot/Port(s)
Create Filter <input type="button" value="v"/>	<input style="width: 150px;" type="text"/>	1 <input type="button" value="v"/>	<div style="border: 1px solid #ccc; padding: 2px;">           0/1 <input type="button" value="▲"/>            0/2 <input type="button" value="□"/>            0/3 <input type="button" value="□"/>            0/4 <input type="button" value="□"/>            0/5 <input type="button" value="□"/>            0/6 <input type="button" value="□"/>            0/7 <input type="button" value="□"/>            0/8 <input type="button" value="▼"/> </div>

### 11.2.2.13.10. Viewing L2 Multicast Group Status Page

Use this panel to display information about entries in the L2Mcast Static/Dynamic Groups. These entries are used by the transparent bridging function to determine how to forward a received frame.

#### Non-Configurable Data

**VLAN** - L2Mcast Group's VLAN ID value.

**MAC Address** - A multicast MAC address for which the switch has forwarding information. The format is a six-byte MAC address. For example: 33:33:00:00:11:11.



**Slot/Ports** - the interface number belongs to this Multicast Group.

**Active State** - The active interface number belongs to this Multicast Group.

#### Command Buttons

**Refresh** - Refresh the database and display it again starting with the first entry in the table.

L2 Multicast Static Groups Status

 Print
  Reload
  Help

VLAN	MAC Address	Slot/Port(s)	Active State
1	33:33:77:55:22:13	0/3, 0/4, 0/5, 0/6	0/3, 0/4, 0/5, 0/6

### 11.2.2.14 Managing MLD Snooping Querier

#### 11.2.2.14.1. Configuring MLD Snooping Querier Configuration Page

Use this menu to configure the parameters for MLD Snooping Querier, Note that only a user with Read/Write access privileges may change the data on this screen.

#### Configurable Data

**Snooping Querier Admin Mode** - Select the administrative mode for MLD Snooping for the switch from the pulldown menu. The default is disable.

**Snooping Querier Address** - Specify the Snooping Querier Address to be used as source address in periodic MLD queries. This address is used when no address is configured on the VLAN on which query is being sent.

**MLD Version** - Specify the MLD protocol version used in periodic MLD queries. MLD queries.

**Query Interval** - Specify the time interval in seconds between periodic queries sent by the snooping querier. The Query Interval must be a value in the range of 1 and 1800. The default value is 60.

**Querier Expiry Interval** - Specify the time interval in seconds after which the last querier information is removed. The Querier Expiry Interval must be a value in the range of 60 and 300. The default value is 60.

### Configurable Data

**Submit** - Update the switch with the configured values.

**Refresh** - Reload the information on the page.

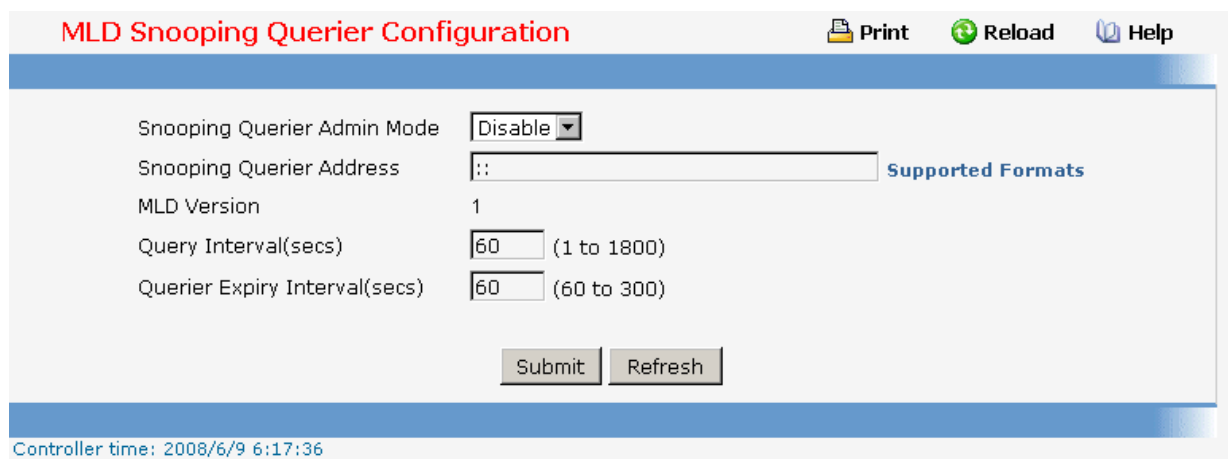

### 11.2.2.14.2. Configuring MLD Snooping VLAN Configuration Page

#### Selection Criteria

**VLAN ID** - Selects the VLAN ID on which MLD Snooping Querier is enabled.

#### Configurable Data

**VLAN ID** - Appears when "New Entry" is selected in VLAN ID selection list. Specifies VLAN ID for which MLD Snooping Querier is to be enabled. User can also set pre-configurable Snooping Querier parameters.

**Querier Election Participate Mode** - Enable or disable the Igmp Snooping Querier participate in election mode. When this mode is disabled, up on seeing other querier of

same version in the vlan, the snooping querier move to non querier state. Only when this mode is enabled, the snooping querier will participate in querier election where in the least ip address will win the querier election and operates as the querier in that VLAN. The other querier moves to non-querier state.

**Snooping Querier VLAN Address** - Specify the Snooping Querier Address to be used as source address in periodic MLD queries sent on the specified VLAN.

### Command Buttons

**Submit** - Update the switch with the configured values.

**Delete** - To disable Snooping Querier on the selected VLAN. This button is not visible when a VLAN is not selected.

**Refresh** - Reload the information on the page.

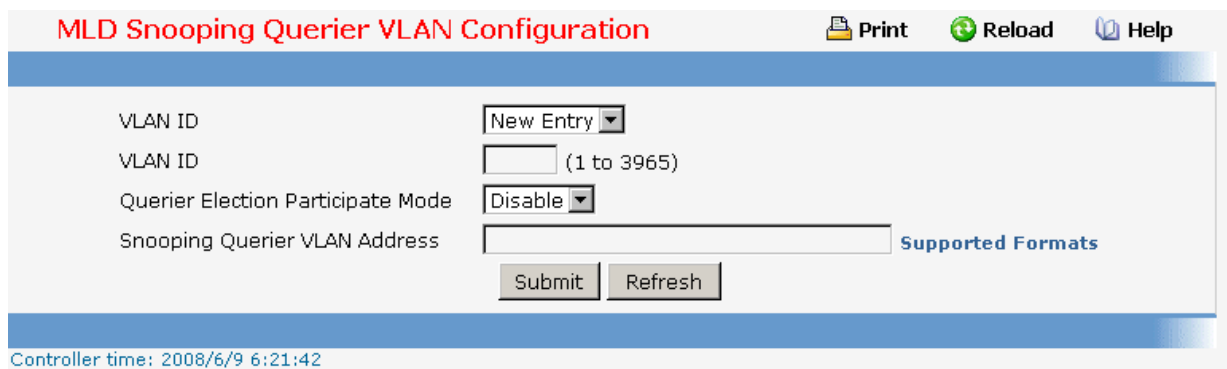

### 11.2.2.14.3. Configuring MLD Snooping VLAN Configuration Summary Page

#### Configurable Data

**VLAN ID Search** - Enter VLAN ID, then click on the search button. If the record exists, that entry will be displayed. An exact match is required.

#### Non-Configurable Data

**VLAN ID** - Specifies the VLAN ID on which MLD Snooping Querier is administratively enabled.

**Admin Mode** - Display the administrative mode for MLD Snooping for the switch.

**Querier Election Participate Mode** - Displays the querier election participate mode on the VLAN. When this mode is disabled, up on seeing a query of the same version in the vlan, the snooping querier move to non querier state. Only when this mode is enabled, the snooping querier will participate in querier election where in the least ip address will win the querier election and operates as the querier in that VLAN. The other querier moves to non-querier state.



**Snooping Querier VLAN Address** - Displays the Snooping Querier Address to be used as source address in periodic MLD queries sent on the specified VLAN.

### Command Buttons

**Search** - Search for the specified Vlan ID.

**Refresh** - Reload the information on the page.

**MLD Snooping Querier VLAN Configuration Summary**

 **Print**
 **Reload**
 **Help**

---

VLAN ID	Admin Mode	Querier Election Participate Mode	Snooping Querier VLAN Address
1	Disable	Disable	FE80::

#### 11.2.2.14.4. Configuring MLD Snooping Querier VLAN Status Page

##### Non-Configurable Data

**VLAN ID** - Specifies the VLAN ID on which MLD Snooping Querier is administratively enabled and VLAN exists in the VLAN database.

**Operational State** - Specifies the operational state of the MLD Snooping Querier on a VLAN. It can be in any of the following states:

**Querier** - Snooping switch is the Querier in the VLAN. The Snooping switch will send out periodic queries with a time interval equal to the configured querier query interval. If the snooping switch sees a better querier in the VLAN, it moves to non-querier mode.

**Non-Querier** - Snooping switch is in Non-Querier mode in the VLAN. If the querier expiry interval timer is expires, the snooping switch will move into querier mode.

**Disabled** - Snooping Querier is not operational on the VLAN. The Snooping Querier moves to disabled mode when MLD Snooping is not operational on the VLAN or when the querier address is not configured or the network management address is also not configured.

**Operational Version** - Displays the operational MLD protocol version of the querier.

**Last Querier Address** - Displays the IP address of the last querier from which a query was snooped on the VLAN.

**Last Querier Version** - Displays the IGMP protocol version of the last querier from which a query was snooped on the VLAN.

**Operational Max Response Time** - Displays maximum response time to be used in the queries that are sent by the Snooping Querier.

MLD Snooping Querier VLAN Status					
VLAN ID	Operational State	Operational Version	Last Querier Address	Last Querier Version	Operational Max Response Time (secs)
Controller time: 2008/6/9 6:27:40					

### 11.2.2.15 Managing Port-Channel

#### 11.2.2.15.1. Configuring Port-Channel Configuration Page

##### Selection Criteria

**Port Channel Name** – You can use this screen to reconfigure an existing Port Channel, or to create a new one. Use this pull down menu to select one of the existing Port Channels, or select 'Create' to add a new one. There can be a maximum of 6 Port Channels.

##### Configurable Data

**Port Channel Name** - Enter the name you want assigned to the Port Channel. You may enter any string of up to 15 alphanumeric characters. A valid name has to be specified in order to create the Port Channel.

**Link Trap** - Specify whether you want to have a trap sent when link status changes. The factory default is enable, which will cause the trap to be sent.

**Administrative Mode** - Select enable or disable from the pull down menu. When the Port Channel is disabled no traffic will flow and LACPDU's will be dropped, but the links that form the Port Channel will not be released. The factory default is enabled.

**STP Mode** - The Spanning Tree Protocol Administrative Mode associated with the Port Channel. The possible values are:

Disable - spanning tree is disabled for this Port Channel.

Enable - spanning tree is enabled for this Port Channel.

**Static Mode** - Select static or dynamic from the pull down menu. The factory default is disabled.

**Load Balance Mode** - Select load balance mode from the pull down menu. The factory default is Source XOR Destination MAC address.

**Participation** - For each port specify whether it is to be included as a member of this Port Channel or not. The default is excluded. There can be a maximum of 8 ports assigned to a Port Channel.

##### Non-Configurable Data

**Slot/Port** - Slot/Port identification of the Port Channel being configured. This field will not

appear when a new Port Channel is being created.

**Link Status** - Indicates whether the Link is up or down.

**Port Channel Members** - List of members of the Port Channel in Slot/Port form.

**Membership Conflicts** - Shows ports that are already members of other Port Channels. A port may only be a member of one Port Channel at a time. If the entry is blank, it is not currently a member of any Port Channel.

**Command Buttons**

**Submit** - Update the switch with the values on this screen. If you want the switch to retain the new values across a power cycle, you must perform a save.

**Delete** - Removes the currently selected configured Port Channel. All ports that were members of this Port Channel are removed from the Port Channel and included in the default VLAN. This field will not appear when a new Port Channel is being created.

**Refresh** - Refresh the data on the screen with the present state of the data in the switch.

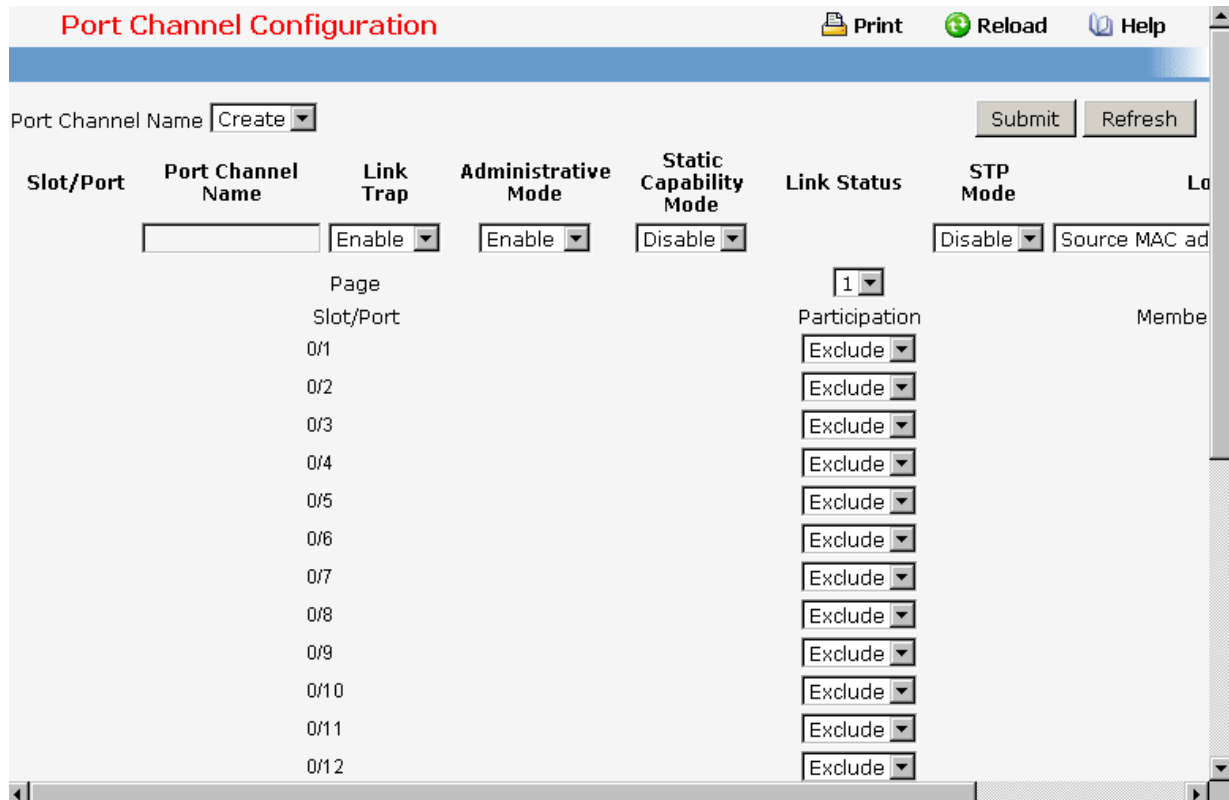

Slot/Port	Port Channel Name	Link Trap	Administrative Mode	Static Capability Mode	Link Status	STP Mode	Lo
		Enable	Enable	Disable		Disable	Source MAC ad
					1		
		Page			Participation		Membe
0/1					Exclude		
0/2					Exclude		
0/3					Exclude		
0/4					Exclude		
0/5					Exclude		
0/6					Exclude		
0/7					Exclude		
0/8					Exclude		
0/9					Exclude		
0/10					Exclude		
0/11					Exclude		
0/12					Exclude		

**11.2.2.15.2. Viewing Port-Channel Information Page**

**Non-Configurable Data**

**Port Channel** - The Slot/Port identification of the Port Channel.

**Port Channel Name** - The name of the Port Channel.



**Port Channel Type** - The type of this Port Channel.

**Admin Mode** - The Administrative Mode of the Port Channel, enable or disable.

**Static Mode** – Indicates whether port channel is static or dynamic.

**Link Status** - Indicates whether the Link is up or down.

**STP Mode** - The Spanning Tree Protocol Administrative Mode associated with the Port Channel. The possible values are:

Disable - spanning tree is disabled for this Port Channel.

Enable - spanning tree is enabled for this Port Channel.

**Link Trap** - Whether or not a trap will be sent when link status changes. The factory default is enabled.

**Configured Ports** - A list of the ports that are members of the Port Channel, in Slot/Port notation. There can be a maximum of 8 ports assigned to a Port Channel.

**Active Ports** - A listing of the ports that are actively participating members of this Port Channel, in Slot/Port notation. There can be a maximum of 8 ports assigned to a Port Channel.

**Load Balance** – Indicates load-balance mode of port channel. The possible values are:

- Source MAC address - Sets the mode on the source MAC address.
- Destination MAC address - Sets the mode on the destination MAC address.
- Source and destination MAC address - Sets the mode on the source and destination MAC addresses.
- Source IP address - Sets the mode on the source IP address.
- Destination IP address - Sets the mode on the destination IP address.
- Source and destination IP address - Sets the mode on the source and destination IP addresses.

Port Channel Status										
Port Channel	Port Channel Name	Port Channel Type	Admin Mode	Link State	STP Mode	Static Mode	Link Trap	Configured Ports	Active Ports	Load Balance
3/1	LAG-1	Dynamic	Enable	Link Down	Enable	Disable	Enable	0/1 0/2		Source and destination MAC address

### 11.2.2.16 Viewing Multicast Forwarding Database

### 11.2.2.16.1. Viewing All of Multicast Forwarding Database Tables Page

The Multicast Forwarding Database holds the port membership information for all active multicast address entries. The key for an entry consists of a VLAN ID and MAC address pair. Entries may contain data for more than one protocol.

Use this screen to display the MFDB information for a specific entry. To display all of the entries for a particular protocol use one of the following menus:

**MAC Filter Summary** - Static MAC address filtering entries

**MFDB GMRP Table** - GARP Multicast Registration Protocol entries

**MFDB IGMP Snooping Table** - IGMP Snooping entries

#### Selection Criteria

**MAC Address** - Enter the VLAN ID - MAC Address pair whose MFDB table entry you want displayed. Enter eight two-digit hexadecimal numbers separated by colons, for example 00:01:23:43:45:67:89:AB. The first two two-digit hexadecimal numbers are the VLAN ID and the remaining numbers are the MAC address. Then click on the "Search" button. If the address exists, that entry will be displayed. An exact match is required.

#### Non-Configurable Data

**MAC Address** - The multicast MAC address for which you requested data.

**Type** - This displays the type of the entry. Static entries are those that are configured by the end user. Dynamic entries are added to the table as a result of a learning process or protocol.

**Component** - This is the component that is responsible for this entry in the Multicast Forwarding Database. Possible values are IGMP Snooping, GMRP, and Static Filtering.

**Description** - The text description of this multicast table entry. Possible values are Management Configured, Network Configured, and Network Assisted.



**Slot/Port(s)** - The list of interfaces that are designated for forwarding (Fwd:) and filtering (Flt:) for the selected address.

**Forwarding Slot/Port(s)** - The resultant forwarding list is derived from combining all the forwarding interfaces and removing the interfaces that are listed as the static filtering interfaces.

#### Command Buttons

**Refresh** - Refresh the data on the screen with the present state of the data in the switch.

Multicast Forwarding Database Table

 Print
  Reload
  Help

MAC Address

MAC Address	Component	Type	Description	Slot/Port	Forwarding Slot/Port(s)
00:01:01:00:5E:00:01:08	IGMP Snooping	Dynamic	Network Assist	Fwd: 0/15 0/16 0/19	Fwd: 0/15 0/16 0/19

### 11.2.2.16.2. Viewing GMRP MFDB Table Page

This screen will display all of the entries in the Multicast Forwarding Database that were created for the GARP Multicast Registration Protocol.

#### Non-Configurable Data

**MAC Address** - A VLAN ID - multicast MAC address pair for which the switch has forwarding and/or filtering information. The format is 8 two-digit hexadecimal numbers that are separated by colons, for example 00:01:23:45:67:89:AB:CD.

**Type** - This displays the type of the entry. Static entries are those that are configured by the user. Dynamic entries are added to the table as a result of a learning process or protocol.

**Description** - The text description of this multicast table entry. Possible values are Management Configured, Network Configured, and Network Assisted.

**Slot/Port(s)** - The list of interfaces that are designated for forwarding (Fwd:) and filtering (Flt:).

#### Command Buttons

**Refresh** - Refresh the data on the screen with the present state of the data in the switch.

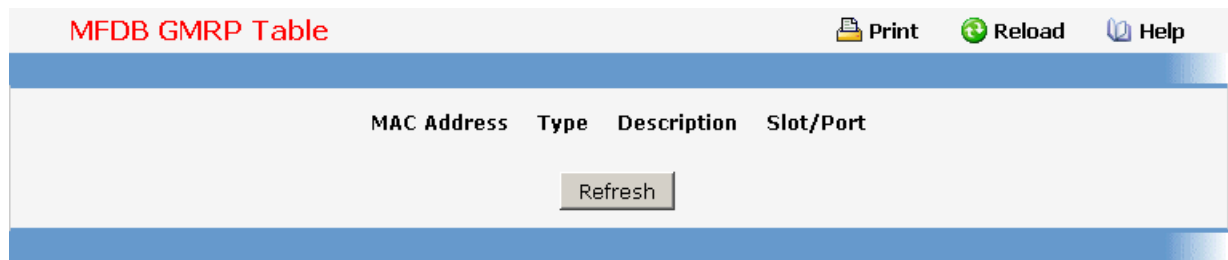

### 11.2.2.16.3. Viewing IGMP Snooping MFDB Table Page

#### Non-Configurable Data

**MAC Address** - A VLAN ID - multicast MAC address pair for which the switch has forwarding and/or filtering information. The format is 8 two-digit hexadecimal numbers that are separated by colons, for example 00:01:23:45:67:89:AB:CD.

**Type** - This displays the type of the entry. Static entries are those that are configured by the user. Dynamic entries are added to the table as a result of a learning process or protocol.

**Description** - The text description of this multicast table entry. Possible values are Management Configured, Network Configured, and Network Assisted.

**Slot/Port(s)** - The list of interfaces that are designated for forwarding (Fwd:) and filtering (Flt:).

#### Command Buttons

**Refresh** - Refresh the data on the screen with the present state of the data in the switch.

**Clear Entries** - Clicking this button tells the IGMP Snooping component to delete all of its entries from the multicast forwarding database.

MFDB IGMP Snooping Table			
<b>MAC Address</b>	<b>Type</b>	<b>Description</b>	<b>Slot/Port</b>
00:01:01:00:5E:00:01:08	Dynamic	Network Assist	Fwd: 0/15, 0/16, 0/19
<input type="button" value="Refresh"/> <input type="button" value="Clear Entries"/>			

#### 11.2.2.16.4. Viewing MLD Snooping MFDB Table Page

##### Non-Configurable Data

**MAC Address** - A VLAN ID - multicast MAC address pair for which the switch has forwarding and or filtering information. The format is 8 two-digit hexadecimal numbers that are separated by colons, for example 00:01:23:45:67:89:AB:CD.

**Type** - This displays the type of the entry. Static entries are those that are configured by the user. Dynamic entries are added to the table as a result of a learning process or protocol.

**Description** - The text description of this multicast table entry. Possible values are Management Configured, Network Configured and Network Assisted.

**Slot/Port(s)** - The list of interfaces that are designated for forwarding (Fwd:) and filtering (Fit:).

##### Command Buttons

**Clear Entries** - Clicking this button tells the MLD Snooping component to delete all of its entries from the multicast forwarding database.

**Refresh** - Refresh the data on the screen with the present state of the data in the switch.

MFDB MLD Snooping Table			
<b>MAC Address</b>	<b>Type</b>	<b>Description</b>	<b>Slot/Port</b>
00:01:33:33:77:55:22:13	Dynamic	Network Assist	Fwd: 0/3, 0/4, 0/5, 0/6
<input type="button" value="Refresh"/> <input type="button" value="Clear Entries"/>			

#### 11.2.2.16.5. Viewing Multicast Forwarding Database Statistics Page

##### Non-Configurable Data

**Max MFDB Entries** - The maximum number of entries that the Multicast Forwarding Database table can hold.

**Most MFDB Entries Since Last Reset** - The largest number of entries that have been present in the Multicast Forwarding Database table since last reset. This value is also known as the MFDB high-water mark.

**Current Entries** - The current number of entries in the Multicast Forwarding Database

table.

### Command Buttons

**Refresh** - Refresh the data on the screen with the present state of the data in the switch.

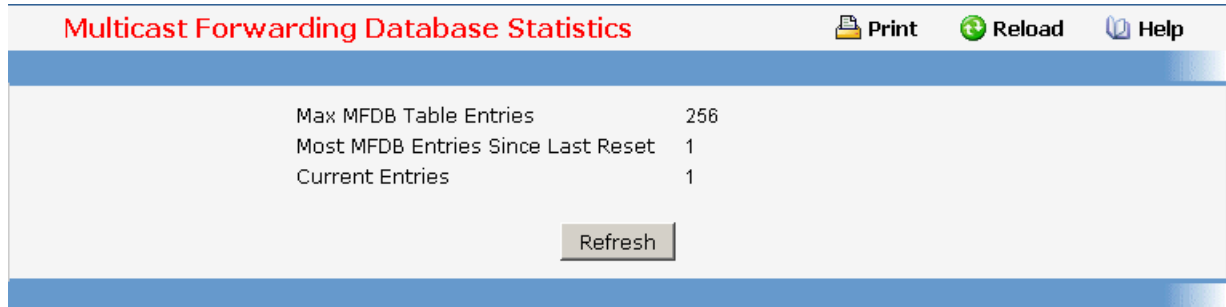

The screenshot shows a web interface titled "Multicast Forwarding Database Statistics". At the top right, there are three icons: a printer for "Print", a green circular arrow for "Reload", and a document with a question mark for "Help". The main content area contains a table with the following data:

Max MFDB Table Entries	256
Most MFDB Entries Since Last Reset	1
Current Entries	1

Below the table is a "Refresh" button.

## 11.2.2.17 Managing Spanning Tree

### 11.2.2.17.1. Configuring Switch Spanning Tree Configuration Page

#### Configurable Data

**Spanning Tree Mode** - Specifies whether spanning tree operation is enabled on the switch. Value is enabled or disabled

**Force Protocol Version** - Specifies the Force Protocol Version parameter for the switch. The options are IEEE 802.1d, IEEE 802.1w, and IEEE 802.1s The default value is IEEE 802.1w.

**Configuration Name**- Identifier used to identify the configuration currently being used. It may be up to 32 alphanumeric characters

**Configuration Revision Level** - Identifier used to identify the configuration currently being used. The values allowed are between 0 and 65535. The default value is 0.

#### Non-Configurable Data

**Configuration digest key** - Identifier used to identify the configuration currently being used.

**MST Table** - Table consisting of the MST instances (including the CST) and the corresponding VLAN IDs associated with each of them.

**VID Table** - Table consisting of the VLAN IDs and the corresponding FID associated with each of them.



**FID Table** - Table consisting of the FIDs and the corresponding VLAN IDs associated with each of them.

#### Command Buttons

**Submit** - Applies the new configuration and causes the changes to take effect. These changes will not be retained across a power cycle unless a save configuration is performed.

**Refresh** - Refreshes the screen with most recent data.

**Spanning Tree Switch Configuration/Status**

 Print
  Reload
  Help

---

Spanning Tree Admin Mode

Force Protocol Version

Configuration Name

Configuration Revision Level  (0 to 65535)

Configuration Digest Key

MST ID	VID	FID
CST	1 1002 1003 1004 1005	1 1002 1003 1004 1005

### 11.2.2.17.2. Configuring Spanning Tree CST Configuration Page

#### Configurable Data

**Bridge Priority** - Specifies the bridge priority for the Common and Internal Spanning tree (CST). The value lies between 0 and 61440. It is set in multiples of 4096. For example, if you set the priority to any value between 0 and 4095, it will be set to 0. If it is tried to be set to any value between 4096 and  $(2 \times 4096 - 1)$  it will be set to 4096 and so on. The default priority is 32768.

**Bridge Max Age** - Specifies the bridge max age for the Common and Internal Spanning tree (CST). The value lies between 6 and 40, with the value being less than or equal to  $2 \times (\text{Bridge Forward Delay} - 1)$  and greater than or equal to  $2 \times (\text{Bridge Hello Time} + 1)$ . The default value is 20.

**Bridge Hello Time** - Specifies the bridge hello time for the Common and Internal Spanning tree (CST), with the value being less than or equal to  $(\text{Bridge Max Age} / 2) - 1$ . The default hello time value is 2.

**Bridge Forward Delay**- Specifies the time spent in "Listening and Learning" mode before forwarding packets. Bridge Forward Delay must be greater or equal to  $(\text{Bridge Max Age} / 2) + 1$ . The time range is from 4 seconds to 30 seconds. The default value is 15.

**Spanning Tree Maximum Hops**- Configure the maximum number of hops for the Spanning tree.

#### Non-Configurable Data

**Bridge identifier** - The bridge identifier for the CST. It is made up using the bridge priority and the base MAC address of the bridge.

**Time since topology change** - The time in seconds since the topology of the CST last changed.

**Topology change count** - Number of times topology has changed for the CST.

**Topology change** - The value of the topology change parameter for the switch indicating if a topology change is in progress on any port assigned to the CST. It takes a value if True or False.

**Designated root** - The bridge identifier of the root bridge. It is made up from the bridge

priority and the base MAC address of the bridge.

**Root Path Cost** - Path Cost to the Designated Root for the CST.

**Root Port** - Port to access the Designated Root for the CST.

**Max Age** - Path Cost to the Designated Root for the CST.

**Forward Delay** - Derived value of the Root Port Bridge Forward Delay parameter.

**Hello Time** - Derived value of the Root Port Bridge Hello Time parameter.

**Hold Time** - Minimum time between transmission of Configuration BPDUs.

**CST Regional Root** - Priority and base MAC address of the CST Regional Root.



**CST Path Cost** - Path Cost to the CST tree Regional Root.

### Command Buttons

**Submit** - Applies the new configuration and causes the changes to take effect. These changes will not be retained across a power cycle unless a save configuration is performed.

**Refresh** - Refreshes the screen with most recent data.

Spanning Tree CST Configuration/Status

 Print
 Reload
 Help

Bridge Priority	<input style="width: 60px;" type="text" value="32768"/> (0 to 61440)
Bridge Max Age (secs)	<input style="width: 30px;" type="text" value="20"/> (6 to 40)
Bridge Hello Time (secs)	<input style="width: 30px;" type="text" value="2"/> (1 to 10)
Bridge Forward Delay (secs)	<input style="width: 30px;" type="text" value="15"/> (4 to 30)
Spanning Tree Maximum Hops	<input style="width: 30px;" type="text" value="20"/> (1 to 127)
Bridge Identifier	80:00:00:c0:9f:00:29:12
Time Since Topology Change	0 day 4 hr 14 min 12 se
Topology Change Count	0
Topology Change	False
Designated Root	80:00:00:c0:9f:00:29:12
Root Path Cost	0
Root Port	00:00
Max Age (secs)	20
Forward Delay (secs)	15
Hello Time	2
Hold Time (secs)	3
CST Regional Root	80:00:00:c0:9f:00:29:12
CST Path Cost	0

### 11.2.2.17.3. Configuring Spanning Tree MST Configuration Page

#### Selection Criteria

**MST ID** - Create a new MST which you wish to configure or configure already existing MSTs.

#### Configurable Data

**MST ID** - This is only visible when the select option of the MST ID select box is selected. The ID of the MST being created. Valid values for this are between 1 and 4054.

**Priority** - The bridge priority for the MST instance selected. The bridge priority is set in multiples of 4096. For example if you attempt to set the priority to any value between 0 and 4095, it will be set to 0. If you attempt to set any value between 4096 and  $(2*4096-1)$  it will be set to 4096 and so on.

**VLAN ID** - This gives a list box of all VLANs on the switch. The VLANs associated with the MST instance which is selected are highlighted on the list. These can be selected or unselected for re-configuring the association of VLANs to MST instances.

#### Non-Configurable Data

**Bridge identifier** - The bridge identifier for the selected MST instance. It is made up using the bridge priority and the base MAC address of the bridge.

**Time since topology change** - The time in seconds since the topology of the selected MST instance last changed.

**Topology change count** - Number of times the topology has changed for the selected MST instance.

**Topology change** - The value of the topology change parameter for the switch indicating if a topology change is in progress on any port assigned to the selected MST instance. It takes a value if True or False.

**Designated root** - The bridge identifier of the root bridge. It is made up from the bridge priority and the base MAC address of the bridge

**Root Path Cost** - Path Cost to the Designated Root for this MST instance.

**Root port** - Port to access the Designated Root for this MST instance.

#### Command Buttons



**Submit** - Applies the new configuration and causes the changes to take effect. These changes will not be retained across a power cycle unless a save configuration is performed.

**Delete** - Deletes the selected MST instance. All VLANs associated with the instance are associated with the CST

**Refresh** - Refreshes the screen with most recent data.



Spanning Tree MST Configuration/Status

 Print
  Reload
  Help

---

MST	<input type="text" value="1"/>	
Priority	<input type="text" value="32768"/> (0 to 61440)	
VLAN ID	<input type="text" value="1"/> <ul style="list-style-type: none"> <li>1</li> <li>1002</li> <li>1003</li> <li>1004</li> <li>1005</li> </ul>	
Bridge Identifier	80:01:00:c0:9f:11:22:99	
Time Since Topology Change	0 day 3 hr 35 min 42 se	
Topology Change Count	0	
Topology Change	False	
Designated Root	80:01:00:c0:9f:11:22:99	
Root Path Cost	0	
Root Port	00:00	

#### 11.2.2.17.4. Configuring each Port CST Configuration Page

##### Selection Criteria

**Slot/Port** - Selects one of the physical or LAG interfaces associated with VLANs associated with the CST.

##### Configurable Data

**Port Priority** - The priority for a particular port within the CST. The port priority is set in multiples of 16. For example, if you attempt to set the priority to any value between 0 and 15, it will be set to 0. If you attempt to set any value between 16 and (2\*16-1) it will be set to 16 and so on.

**Admin Edge Port** - Specifies if the specified port is an Edge Port within the CIST. It takes a value of Enable or Disable, where the default value is Disable.

**Port Path Cost** - Set the Path Cost to a new value for the specified port in the common and internal spanning tree. It takes a value in the range of 1 to 200000000.

**External Port Path Cost** - Set the External Path Cost to a new value for the specified port in the spanning tree. It takes a value in the range of 1 to 200000000.

**Port Mode** - Spanning Tree Protocol Administrative Mode associated with the port or port channel. The possible values are Enable or Disable.

##### Non-Configurable Data

**Auto-calculate Port Path Cost** - Displays whether the path cost is automatically calculated (Enabled) or not (Disabled). Path cost will be calculated based on the link

speed of the port if the configured value for Port Path Cost is zero.

**Auto-calculate External Port Path Cost** - Displays whether the external path cost is automatically calculated (Enabled) or not (Disabled). External Path cost will be calculated based on the link speed of the port if the configured value for External Port Path Cost is zero.

**Port ID** - The port identifier for the specified port within the CST. It is made up from the port priority and the interface number of the port.

**Port Up Time Since Counters Last Cleared** - Time since the counters were last cleared, displayed in Days, Hours, Minutes, and Seconds.

**Port Forwarding State** - The Forwarding State of this port.

**Port Role** - Each MST Bridge Port that is enabled is assigned a Port Role for each spanning tree. The port role will be one of the following values: Root Port, Designated Port, Alternate Port, Backup Port, Master Port, or Disabled Port.

**Designated Root** - Root Bridge for the CST. It is made up using the bridge priority and the base MAC address of the bridge.

**Designated Cost** - Path Cost offered to the LAN by the Designated Port.

**Designated Bridge** - Bridge Identifier of the bridge with the Designated Port. It is made up using the bridge priority and the base MAC address of the bridge.

**Designated Port** - Port Identifier on the Designated Bridge that offers the lowest cost to the LAN. It is made up from the port priority and the interface number of the port.

**Topology Change Acknowledge** - Identifies whether the next BPDU to be transmitted for this port would have the topology change acknowledgement flag set. It is either "True" or "False".

**Edge port** - indicates whether the port is enabled as an edge port. It takes the value "Enabled" or "Disabled".

**Point-to-point MAC** - Derived value of the point-to-point status.

**CST Regional Root** - Bridge Identifier of the CST Regional Root. It is made up using the bridge priority and the base MAC address of the bridge.

**CST Path Cost** - Path Cost to the CST Regional Root.

### Command Buttons

**Submit** - Applies the new configuration and causes the changes to take effect. These changes will not be retained across a power cycle unless a save configuration is performed.

**Refresh** - Refreshes the screen with most recent data.

**Force** - Clicking this button will force the port to send out 802.1w or 802.1s BPDUs.

Slot/Port	0/1
Port Priority	128 (0 to 240)
Admin Edge Port	Disable
Port Path Cost	0 (0 to 200000000) 0 = Auto
Auto-calculate Port Path Cost	Enabled
External Port Path Cost	0 (0 to 200000000) 0 = Auto
Auto-calculate External Prt Path Cost	Enabled
Port ID	80:01
Port Up Time Since Counters Last Cleared	0 day 3 hr 10 min 53 se
Port Mode	Disable
Port Forwarding State	Disabled
Port Role	Disabled
Designated Root	80:00:00:c0:9f:00:29:12
Designated Cost	0
Designated Bridge	80:00:00:c0:9f:00:29:12
Designated Port	00:00
Topology Change Acknowledge	False
Edge Port	Disabled
Point-to-point MAC	True
CST Regional Root	80:00:00:c0:9f:00:29:12
CST Path Cost	0

©2007 Quanta Computer, Inc. All Rights Reserved

### 11.2.2.17.5. Configuring each Port MST Configuration Page

#### Selection Criteria

**MST ID** - Selects one MST instance from existing MST instances.

**Slot/Port** - Selects one of the physical or LAG interfaces associated with VLANs associated with the selected MST instance.

#### Configurable Data

**Port Priority** - The priority for a particular port within the selected MST instance. The port priority is set in multiples of 16. For example, if you set the priority to any value between 0 and 15, it will be set to 0. If it is tried to be set to any value between 16 and (2\*16-1) it will be set to 16 and so on.

**Port Path Cost** - Set the Path Cost to a new value for the specified port in the selected MST instance. It takes a value in the range of 1 to 200000000.

#### Non-Configurable Data

**Auto-calculate Port Path Cost** - Displays whether the path cost is automatically calculated (Enabled) or not (Disabled). Path cost will be calculated based on the link speed of the port if the configured value for Port Path Cost is zero.

**Port ID** - The port identifier for the specified port within the selected MST instance. It is made up from the port priority and the interface number of the port.

**Port Up Time Since Counters Last Cleared** - Time since the counters were last cleared, displayed in Days, Hours, Minutes, and Seconds.

**Port Mode** - Spanning Tree Protocol Administrative Mode associated with the port or LAG. The possible values are Enable or Disable.

**Port Forwarding State** - The Forwarding State of this port.

**Port Role** - Each MST Bridge Port that is enabled is assigned a Port Role for each spanning tree. The port role will be one of the following values: Root Port, Designated Port, Alternate Port, Backup Port, Master Port, or Disabled Port.

**Designated Root** - Root Bridge for the selected MST instance. It is made up using the bridge priority and the base MAC address of the bridge.

**Designated Cost** - Path Cost offered to the LAN by the Designated Port.

**Designated Bridge** - Bridge Identifier of the bridge with the Designated Port. It is made up using the bridge priority and the base MAC address of the bridge.



**Designated Port** - Port Identifier on the Designated Bridge that offers the lowest cost to the LAN. It is made up from the port priority and the interface number of the port.

### Command Buttons

**Submit** - Applies the new configuration and causes the changes to take effect. These changes will not be retained across a power cycle unless a save configuration is performed.

**Refresh** - Refreshes the screen with most recent data.

Spanning Tree MST Port Configuration/Status

 **Print**   
  **Reload**   
  **Help**

MST ID	<input type="text" value="1"/>
Slot/Port	<input type="text" value="0/1"/>
Port Priority	<input type="text" value="128"/> (0 to 240)
Port Path Cost	<input type="text" value="0"/> (0 to 200000000) 0 = Auto
Auto-calculate Port Path Cost	Enabled
Port ID	80:01
Port Up Time Since Counters Last Cleared	0 day 0 hr 1 min 37 sec
Port Mode	Disabled
Port Forwarding State	Disabled
Port Role	Disabled
Designated Root	80:01:00:c0:9f:11:22:99
Designated Cost	0
Designated Bridge	80:01:00:c0:9f:11:22:99
Designated Port	00:00

### 11.2.2.17.6. Viewing Spanning Tree Statistics Page

#### Selection Criteria

**Slot/Port** - Selects one of the physical or LAG interfaces of the switch.

#### Non-Configurable Data

**STP BPDUs Received** - Number of STP BPDUs received at the selected port.

**STP BPDUs Transmitted** - Number of STP BPDUs transmitted from the selected port.

**RSTP BPDUs Received** - Number of RSTP BPDUs received at the selected port.

**RSTP BPDUs Transmitted** - Number of RSTP BPDUs transmitted from the selected port.

**MSTP BPDUs Received** - Number of MSTP BPDUs received at the selected port.

**MSTP BPDUs Transmitted** - Number of MSTP BPDUs transmitted from the selected port.

#### Command Buttons

**Refresh** - Refreshes the screen with most recent data.

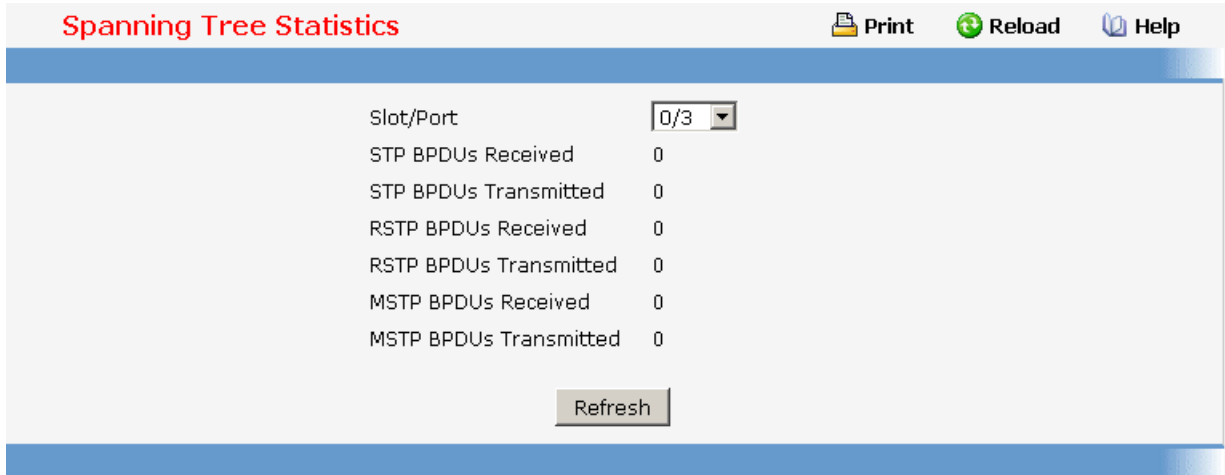

Spanning Tree Statistics	
Slot/Port	0/3
STP BPDUs Received	0
STP BPDUs Transmitted	0
RSTP BPDUs Received	0
RSTP BPDUs Transmitted	0
MSTP BPDUs Received	0
MSTP BPDUs Transmitted	0

Refresh

### 11.2.2.18 Defining 802.1p priority

#### 11.2.2.18.1. Defining 802.1p Priority Mapping Page

#### Selection Criteria

**Slot/Port** - Select the physical interface for which you want to display or configure data. Select 'All' to set the parameters for all ports to the same values.

#### Configurable Data

**Traffic Class** - Specify which internal traffic class to map the corresponding 802.1p priority.

#### Non-Configurable Data

**802.1p Priority** - Displays the 802.1p priority to be mapped.

#### Command Buttons

**Submit** - Update the switch with the values on this screen. If you want the switch to retain the new values across a power cycle, you must perform a save.

**802.1p Priority Mapping** Print Reload Help

---

Slot/Port:

802.1p Priority	Traffic Class
0	<input type="text" value="1"/>
1	<input type="text" value="0"/>
2	<input type="text" value="0"/>
3	<input type="text" value="1"/>
4	<input type="text" value="2"/>
5	<input type="text" value="2"/>
6	<input type="text" value="3"/>
7	<input type="text" value="3"/>

### 11.2.2.19 Managing Port Security

#### 11.2.2.19.1. Configuring Port Security Administration Mode Page

##### Configurable Data

**Allow Port Security** - Used to enable or disable the Port Security feature.

##### Command Buttons

**Submit** - Applies the new configuration and causes the changes to take effect. These changes will not be retained across a power cycle unless a save configuration is performed.

**Port Security Administration** Print Reload Help

---

Port Security Mode:

#### 11.2.2.19.2. Configuring Port Security Interface Page

##### Selection Criteria

**Slot/Port** - Selects the interface to be configured.

### Configurable Data

**Port Security** - Enables or disables the Port Security feature for the selected interface.

**Maximum Number of Dynamically Learned MAC Addresses Allowed** - Sets the maximum number of dynamically learned MAC addresses on the selected interface.

**Add a static MAC address**- Adds a MAC address to the list of statically locked MAC addresses for the selected interface.

**VLAN ID**- Adds a corresponding VLAN ID for the MAC Address being added to the list of statically locked MAC addresses for the selected interface.

**Maximum Number of Statically Locked MAC Addresses Allowed** - Sets the maximum number of statically locked MAC addresses on the selected interface.

**Enable violation traps**- Enables or disables the sending of new violation traps designating when a packet with a disallowed MAC address is received on a locked port.

**Enable violation Shutdown**- Enables or disables the Port Security Violation Shutdown mode for the selected interface.



**Clear Dynamically Learned MAC Addresses** - Clears the Dynamic MAC addresses of the selected interface.

### Command Buttons

**Submit** - Applies the new configuration and causes the changes to take effect. These changes will not be retained across a power cycle unless a save configuration is performed.

**Move** - Convert a dynamically locked MAC address to a statically locked address. The Dynamic MAC address entries are converted to Static MAC address entries in a numerically ascending order till the Static limit is reached.

Port Security Interface Configuration

 Print
  Reload
  Help

---

Slot/Port	0/1 ▾
Port Security	Disable ▾
Maximum Number of Dynamically Learned MAC Addresses Allowed	600 (0-600)
Add a Static MAC Address	<input type="text"/>
VLAN ID	1 (1-3965)
Maximum Number of Statically Locked MAC Addresses Allowed	20 (0-20)
Enable Violation Traps	No ▾
Enable Violation Shutdown	Disable ▾
Clear Dynamically Learned MAC Addresses	<input type="button" value="Clear"/>
Convert dynamically locked address to statically locked	<input type="button" value="Move"/>

### 11.2.2.19.3. Deleting Port Security Statically Configured MAC Address Page

#### Selection Criteria

**Slot/Port** - Select the physical interface for which you want to display data.

**VLAN ID** - selects the VLAN ID corresponding to the MAC address being deleted.

#### Configurable data

**MAC Address** - Accepts user input for the MAC address to be deleted.

#### Non-configurable data

**MAC Address** - Displays the user specified statically locked MAC address.

**VLAN ID** - Displays the VLAN ID corresponding to the MAC address.

**Delete a Static MAC Address** - Deletes the MAC address from the Port-Security Static MAC address table.

**VLAN ID** - Displays the VLAN ID corresponding to the MAC address to be deleted from the Static list.

#### Command Buttons

**Submit** - Applies the new configuration and causes the changes to take effect. These changes will not be retained across a power cycle unless a save configuration is



performed.

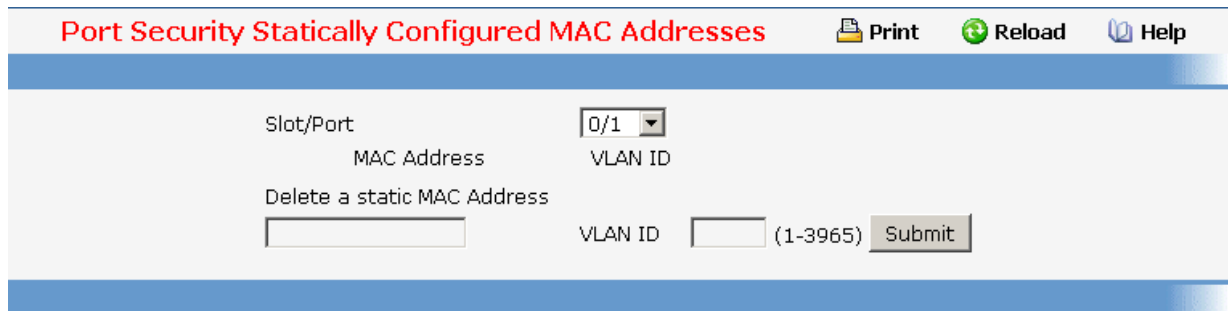

#### 11.2.2.19.4. Viewing Port Security Dynamically Learnt MAC Address Page Selection Criteria

**Slot/Port** - Select the physical interface for which you want to display data.

#### Non-configurable data

**MAC Address** - Displays the MAC addresses learned on a specific port.

**VLAN ID** - Displays the VLAN ID corresponding to the MAC address.

**Number of Dynamic MAC addresses learned** - Displays the number of dynamically learned MAC addresses on a specific port.

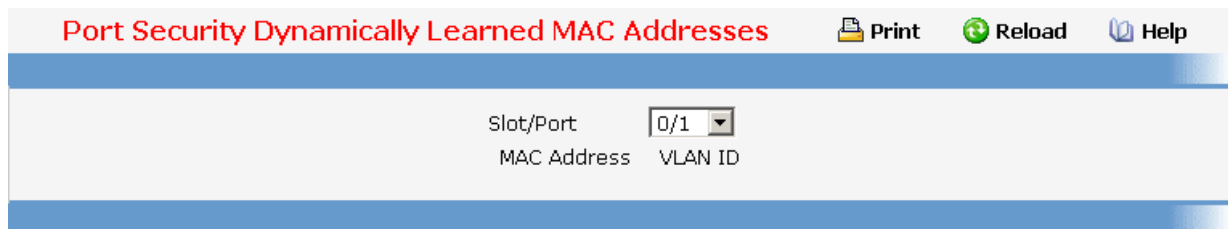

#### 11.2.2.19.5. Viewing Port Security Violation Status Page Selection Criteria



**Slot/Port** - Select the physical interface for which you want to display data.

#### Non-configurable data

**Last Violation MAC Address** - Displays the source MAC address of the last packet that was discarded at a locked port.

**VLAN ID** - Displays the VLAN ID corresponding to the Last Violation MAC address.

Port Security Violation Status

 Print
  Reload
  Help

---

Slot/Port

0/1

Last Violation MAC address

VLAN ID

### 11.2.2.19.6. Clearing Port Security Dynamically Learned MAC Addresses Page

Use this menu to clear a Dynamic MAC addresses of port security on switch.



#### Configurable Data

**Dynamically MAC Address** - Accepts user input for the MAC address to be deleted. The factory default is blank

#### Command Buttons

**Delete** - Send the updated screen to the switch perform the MAC clear

Clear Dynamically MAC Address

 Print
  Reload
  Help

---

Dynamically MAC Address

Delete

### 11.2.2.20 Managing LLDP

#### 11.2.2.20.1. Configuring LLDP Global Configuration Page

#### Configurable Data

**Transmit Interval** - Specifies the interval in seconds to transmit LLDP frames. The range is from (1 to 32768) . Default value is 30 seconds.

**Hold Multiplier** - Specifies the multiplier on Transmit Interval to assign TTL. The range is from (2 to 10). Default value is 4.

**Re-Initialization Delay** - Specifies the delay before re-initialization. The range is from (1 to 10) . Default value is 2 seconds.

**Notification Interval** - Specifies the interval in seconds for transmission of notifications. The range is from (5 to 3600) . Default value is 5 seconds.

### Command Buttons

**Submit** - Send the updated screen to the switch and cause the changes to take effect on the switch but these changes will not be retained across a power cycle unless a save is performed.

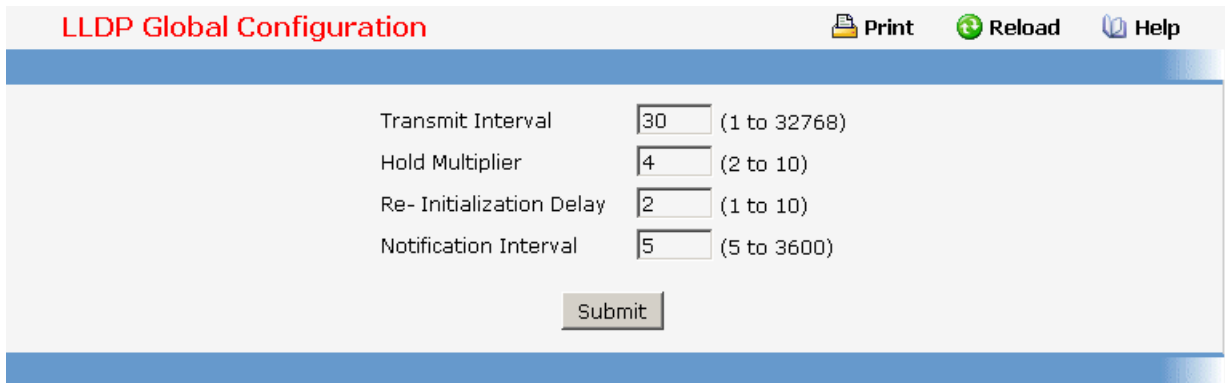

**LLDP Global Configuration** Print Reload Help

Transmit Interval  (1 to 32768)

Hold Multiplier  (2 to 10)

Re- Initialization Delay  (1 to 10)

Notification Interval  (5 to 3600)

### 11.2.2.20.2. Configuring LLDP Interface Configuration Page

#### Selection Criteria

**Interface** - Specifies the list of ports on which LLDP - 802.1AB can be configured.

#### Configurable Data

**Transmit** - Specifies the LLDP - 802.1AB transmit mode for the selected interface.

**Receive** - Specifies the LLDP - 802.1AB receive mode for the selected interface.

**Notify** - Specifies the LLDP - 802.1AB notification mode for the selected interface.

**Transmit Management Information** - Specifies whether management address is transmitted in LLDP frames for the selected interface.



#### Optional TLV(s)

- **System Name** - To include system name TLV in LLDP frames.
- **System Description** - To include system description TLV in LLDP frames.
- **System Capabilities** - To include system capability TLV in LLDP frames.
- **Port Description** - To include port description TLV in LLDP frames.

### Command Buttons

**Submit** - Send the updated screen to the switch and cause the changes to take effect on the switch but these changes will not be retained across a power cycle unless a save is performed.

LLDP Interface Configuration

 **Print**
 **Reload**
 **Help**

---

Interface	0/1 ▾
Transmit	Disable ▾
Receive	Disable ▾
Notify	Disable ▾
Transmit Management Information	<input type="checkbox"/>
Optional TLV(s)	<input type="checkbox"/> System Name <input type="checkbox"/> System Description <input type="checkbox"/> System Capabilities <input type="checkbox"/> Port Description

### 11.2.2.20.3. Viewing LLDP Interface Summary Page

#### Non-Configurable Data

**Interface** - Specifies all the ports on which LLDP - 802.1AB can be configured.

**Link Status** - Specifies the Link Status of the ports whether it is Up/Down.

**Transmit** - Specifies the LLDP - 802.1AB transmit mode of the interface.

**Receive** - Specifies the LLDP - 802.1AB receive mode of the interface.

**Notify** - Specifies the LLDP - 802.1AB notification mode of the interface.

**Optional TLV(s)** - Specifies the LLDP - 802.1AB optional TLV(s) that are included.

**Transmit Management Information** - Specifies whether management address is transmitted in LLDP frames.

#### Command Buttons

**Refresh** - Updates the information on the page.

LLDP Interface Summary						
Interface	Link Status	Transmit	Receive	Notify	Optional TLV (s)	Transmit Management Information
0/1	Link Down	Disabled	Disabled	Disabled		No
0/2	Link Down	Disabled	Disabled	Disabled		No
0/3	Link Down	Disabled	Disabled	Disabled		No
0/4	Link Down	Disabled	Disabled	Disabled		No
0/5	Link Down	Disabled	Disabled	Disabled		No
0/6	Link Down	Disabled	Disabled	Disabled		No
0/7	Link Down	Disabled	Disabled	Disabled		No
0/8	Link Down	Disabled	Disabled	Disabled		No
0/9	Link Down	Disabled	Disabled	Disabled		No
0/10	Link Down	Disabled	Disabled	Disabled		No
0/11	Link Down	Disabled	Disabled	Disabled		No
0/12	Link Down	Disabled	Disabled	Disabled		No
0/13	Link Down	Disabled	Disabled	Disabled		No
0/14	Link Down	Disabled	Disabled	Disabled		No
0/15	Link Down	Disabled	Disabled	Disabled		No
0/16	Link Down	Disabled	Disabled	Disabled		No
0/17	Link Down	Disabled	Disabled	Disabled		No
0/18	Link Down	Disabled	Disabled	Disabled		No
0/19	Link Down	Disabled	Disabled	Disabled		No
0/20	Link Up	Disabled	Disabled	Disabled		No
0/21	Link Down	Disabled	Disabled	Disabled		No
0/22	Link Down	Disabled	Disabled	Disabled		No
0/23	Link Down	Disabled	Disabled	Disabled		No

#### 11.2.2.20.4. Viewing LLDP Statistics Page

##### Non-Configurable Data

**Last Update** - Specifies the time when an entry was created, modified or deleted in the tables associated with the remote system.

**Total Inserts** - Specifies the number of times the complete set of information advertised by a particular MAC Service Access Point (MSAP) has been inserted into tables associated with the remote systems.

**Total Deletes** - Specifies the number of times the complete set of information advertised by a particular MAC Service Access Point (MSAP) has been deleted from tables associated with the remote systems.

**Total Drops** - Specifies the number of times the complete set of information advertised by a particular MAC Service Access Point (MSAP) could not be entered into tables associated with the remote systems because of insufficient resources.

**Total Age outs** - Specifies the number of times the complete set of information advertised by a particular MAC Service Access Point (MSAP) has been deleted from tables associated with the remote systems because the information timeliness interval has expired.

**Interface** - Specifies the slot/port for the interfaces.

**Transmit Total** - Specifies the number of LLDP frames transmitted by the LLDP agent on the corresponding port.

**Receive Total** - Specifies the number of valid LLDP frames received by this LLDP agent on the corresponding port, while the LLDP agent is enabled.

**Discards** - Specifies the number of LLDP TLVs discarded for any reason by the LLDP agent on the corresponding port.

**Errors** - Specifies the number of invalid LLDP frames received by the LLDP agent on the corresponding port, while the LLDP agent is enabled.

**Age outs** - Specifies the number of age-outs that occurred on a given port. An age-out is the number of times the complete set of information advertised by a particular MAC Service Access Point (MSAP) has been deleted from tables associated with the remote entries because information timeliness interval had expired.

**TLV Discards** - Specifies the number of LLDP TLVs discarded for any reason by the LLDP agent on the corresponding port.

**TLV Unknowns** - Specifies the number of LLDP TLVs received on the local ports which were not recognized by the LLDP agent on the corresponding port.

### Command Buttons

**Refresh** - Updates the information on the page.

**Clear** - Clears LLDP Statistics of all the interfaces.

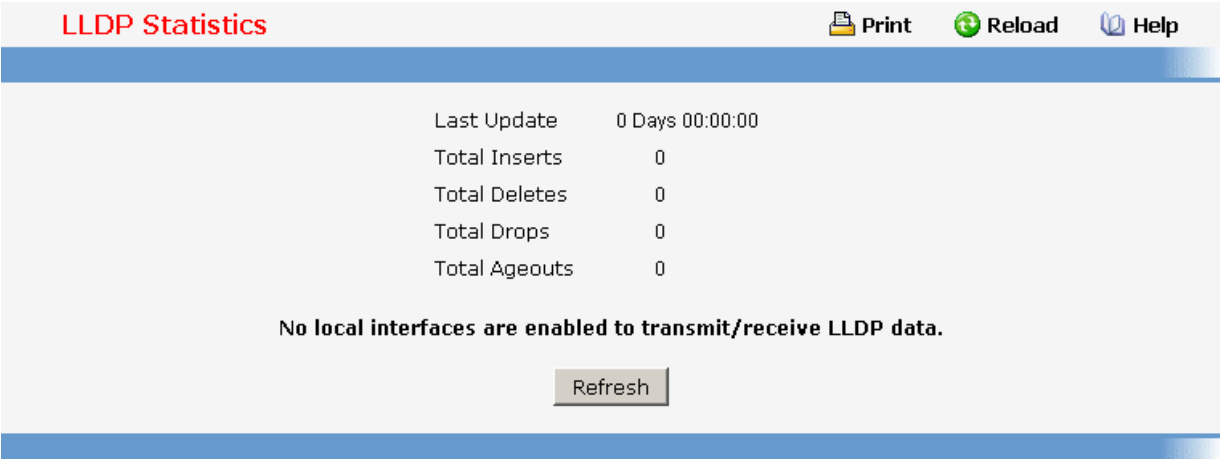

**LLDP Statistics** Print Reload Help

Last Update	0 Days 00:00:00
Total Inserts	0
Total Deletes	0
Total Drops	0
Total Ageouts	0

No local interfaces are enabled to transmit/receive LLDP data.

### 11.2.2.20.5. Viewing LLDP Local Device Information Page

#### Selection Criteria

**Interface** - Specifies the list of all the ports on which LLDP - 802.1AB frames can be transmitted.

### Non-Configurable Data

**Chassis ID Subtype** - Specifies the string that describes the source of the chassis identifier.

**Chassis ID** - Specifies the string value used to identify the chassis component associated with the local system.

**Port ID Subtype** - Specifies the string describes the source of the port identifier.

**Port ID** - Specifies the string that describes the source of the port identifier.

**System Name** - Specifies the system name of the local system.

**System Description** - Specifies the description of the selected port associated with the local system.

**Port Description** - Specifies the description of the selected port associated with the local system.

**System Capabilities Supported** - Specifies the system capabilities of the local system.

**System Capabilities Enabled** - Specifies the system capabilities of the local system which are supported and enabled.

**Management Address** - Specifies the advertised management address of the local system.

**Management Address Type** - Specifies the type of the management address.

### Command Buttons

**Refresh** - Updates the information on the page.

**LLDP Local Device Information** Print Reload Help

Interface	0/1
Chassis ID Subtype	MAC Address
Chassis ID	00:C0:9F:11:22:99
Port ID Subtype	MAC Address
Port ID	00:C0:9F:11:22:9B
System Name	
System Description	Quanta
Port Description	
System Capabilities Supported	bridge, router
System Capabilities Enabled	bridge, router
Management Address	00:C0:9F:11:22:99
Management Address Type	802

**11.2.2.20.6. Viewing LLDP Local Device Summary Page**

**Non-Configurable Data**

**Interface** - Specifies the ports on which LLDP - 802.1AB frames can be transmitted.

**Port ID** - Specifies the string describes the source of the port identifier.

**Port Description** - Specifies the description of the port associated with the local system.

**Command Buttons**

**Refresh** - Updates the information on the page.

**LLDP Local Device Summary** Print Reload Help

Interface	Port ID	Port Description
0/1	00:C0:9F:11:22:9B	

**11.2.2.20.7. Viewing LLDP Remote Device Information Page**

**Selection Criteria**



**Local Interface** - Specifies all the local ports which can receive LLDP frames.

#### Non-Configurable Data

**Chassis ID Subtype** - Specifies the source of the chassis identifier.

**Chassis ID** - Specifies the chassis component associated with the remote system.

**Port ID Subtype** - Specifies the source of port identifier.

**Port ID** - Specifies the port component associated with the remote system.

**System Name** - Specifies the system name of the remote system.

**System Description** - Specifies the description of the given port associated with the remote system.

**Port Description** - Specifies the description of the given port associated with the remote system.

**System Capabilities Supported** - Specifies the system capabilities of the remote system.

**System Capabilities Enabled** - Specifies the system capabilities of the remote system which are supported and enabled.

**Time to Live** - Specifies the Time To Live value in seconds of the received remote entry.



#### Management Address

- **Management Address** - Specifies the advertised management address of the remote system.
- **Type** - Specifies the type of the management address.

#### Command Buttons

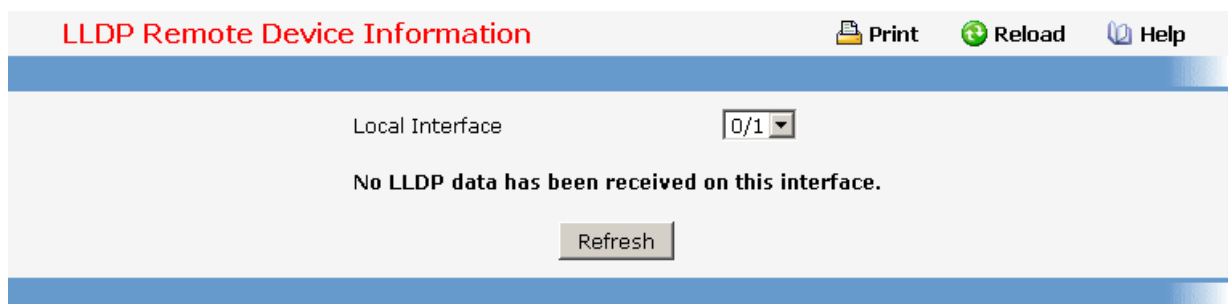
**Refresh** - Updates the information on the page.



**LLDP Remote Device Information**  **Print**  **Reload**  **Help**

Local Interface

No LLDP data has been received on this interface.

### 11.2.2.20.8. Viewing LLDP Remote Device Summary Page

#### Non-Configurable Data

**Local Interface** - Specifies the local port which can receive LLDP frames advertised by a remote system.

**Chassis ID** - Specifies the chassis component associated with the remote system.

**Port ID** - Specifies the port component associated with the remote system.

**System Name** - Specifies the system name of the remote system.

#### Command Buttons

**Refresh** - Updates the information on the page.

**Clear** - Clears LLDP Remote Device information received on all the interfaces.

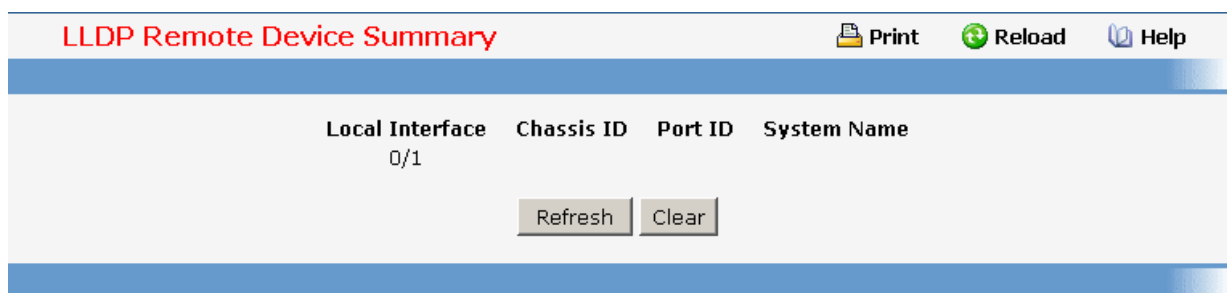

Local Interface	Chassis ID	Port ID	System Name
0/1			

Refresh Clear

### 11.2.2.21 Managing LLDP-MED

#### 11.2.2.21.1. Configuring LLDP-MED Global Configuration Page

##### Configurable Data



**Fast Start Repeat Count** - Specifies the number of LLDP PDUs that will be transmitted when the protocol is enabled. The range is from (1 to 10). Default value of fast repeat count is 3.

**Device Class** - Specifies local device's MED Classification. There are four different kinds of devices, three of them represent the actual end points (classified as Class I Generic [IP Communication Controller etc.], Class II Media [Conference Bridge etc.], Class III Communication [IP Telephone etc.]). The fourth device is Network Connectivity Device, which is typically a LAN Switch/Router, IEEE 802.1 Bridge, IEEE 802.11 Wireless Access Point etc.

##### Command Buttons

**Submit** - Send the updated screen to the switch and cause the changes to take effect on the switch but these changes will not be retained across a power cycle unless a save is performed.

**LLDP-MED Global Configuration**

 **Print**
 **Reload**
 **Help**

---

Fast Start Repeat Count  (1 to 10)

Device Class

---

Controller time: 2008/6/6 13:2:56

### 11.2.2.21.2. Configuring LLDP-MED Interface Configuration Page

#### Selection Criteria

**Interface** - Specifies the list of ports on which LLDP-MED - 802.1AB can be configured. 'All' option is provided to configure all interfaces on the DUT and to be consistent with CLI. To view the summary of all interfaces refer to 'Interface Summary' webpage. Interface configuration page will not be able to display summary of 'All' interfaces, summary of individual interfaces is visible from 'Interface Configuration' webpage. 'Interface Configuration' webpage for 'All' option will always display LLDP-MED mode and notification mode as 'disabled' and checkboxes for 'Transmit TLVs' will always be unchecked.

#### Configurable Data

**LLDP-MED Mode** - Specifies the Link Layer Data Protocol-Media End Point (LLDP-MED) mode for the selected interface. By enabling MED, we will be effectively enabling the transmit and receive function of LLDP.

**Config Notification Mode** - Specifies the LLDP-MED topology notification mode for the selected interface.

**Transmit TLVs** - Specifies which optional type length values (TLVs) in the LLDP-MED will be transmitted in the LLDP PDUs frames for the selected interface.

**MED Capabilities** - To transmit the capabilities TLV in LLDP frames

**Network Policy** - To transmit the network policy TLV in LLDP frames.

**Location Identification** - To transmit the location TLV in LLDP frames.

**Extended Power via MDI - PSE** - To transmit the extended PSE TLV in LLDP frames.

**Extended Power via MDI - PD** - To transmit the extended PD TLV in LLDP frames.

**Inventory** - To transmit the inventory TLV in LLDP frames.

**Command Buttons**

**Submit** - Send the updated screen to the switch and cause the changes to take effect on the switch but these changes will not be retained across a power cycle unless a save is performed.

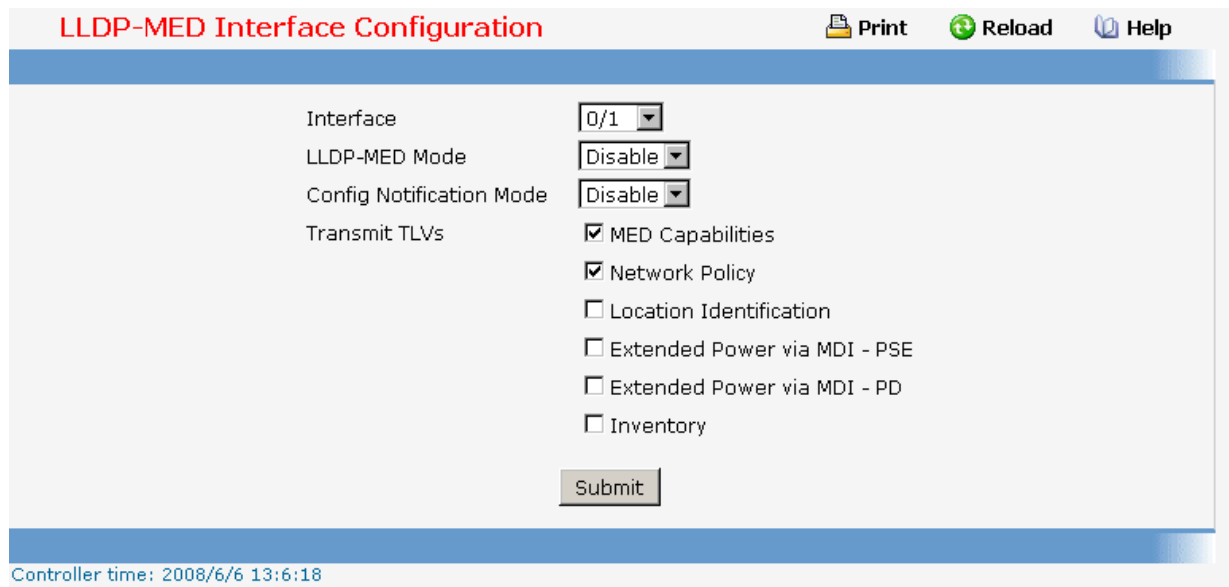

**11.2.2.21.3. Configuring LLDP-MED Interface Summary Page**

**Non-Configurable Data**

**Interface** - Specifies all the ports on which LLDP-MED can be configured.

**Link Status** - Specifies the link status of the ports whether it is Up/Down.

**MED Status** - Specifies the LLDP-MED mode is enabled or disabled on this interface.



**Operational Status** - Specifies the LLDP-MED TLVs are transmitted or not on this interface.

**Notification Status** - Specifies the LLDP-MED topology notification mode of the interface.

**Transmit TLV(s)** - Specifies the LLDP-MED transmit TLV(s) that are included.

**Command Buttons**

**Refresh** - Updates the information on the page.

<b>LLDP-MED Interface Summary</b>						 <b>Print</b>	 <b>Reload</b>	 <b>Help</b>
<b>Interface</b>	<b>Link Status</b>	<b>MED Status</b>	<b>Operational Status</b>	<b>Notification Status</b>	<b>Transmit TLVs</b>			
0/1	Down	Disable	Disable	Disable	Capabilities Network Policy			
0/2	Down	Disable	Disable	Disable	Capabilities Network Policy			
0/3	Down	Disable	Disable	Disable	Capabilities Network Policy			
0/4	Down	Disable	Disable	Disable	Capabilities Network Policy			
0/5	Down	Disable	Disable	Disable	Capabilities Network Policy			
0/6	Down	Disable	Disable	Disable	Capabilities Network Policy			
0/7	Down	Disable	Disable	Disable	Capabilities Network Policy			
0/8	Down	Disable	Disable	Disable	Capabilities Network Policy			
0/9	Down	Disable	Disable	Disable	Capabilities Network Policy			
0/10	Down	Disable	Disable	Disable	Capabilities Network Policy			
0/11	Down	Disable	Disable	Disable	Capabilities Network Policy			

#### 11.2.2.21.4. Configuring LLDP-MED Local Device Information Page

##### Selection Criteria

**Interface** - Specifies the list of all the ports on which LLDP-MED frames can be transmitted.

##### Non-Configurable Data

**Network Policy Information** - Specifies if network policy TLV is present in the LLDP frames.

**Media Application Type** - Specifies the application type. Types of application types are unknown, voicesignaling, guestvoice, guestvoicesignalling, softphonevoice, videoconferencing, streamingvideo, vidoesignalling. Each application type that is received has the VLAN id, priority, DSCP, tagged bit status and unknown bit status. A port may receive one or many such application types. If a network policy TLV has been transmitted only then would this information be displayed.

**Vlan Id** - Specifies the VLAN id associated with a particular policy type.

**Priority** - Specifies the priority associated with a particular policy type.

**DSCP** - Specifies the DSCP associated with a particular policy type.

**Unknown Bit Status** - Specifies the unknown bit associated with a particular policy type.

**Tagged Bit Status** - Specifies the tagged bit associated with a particular policy type.

**Inventory** - Specifies if inventory TLV is present in LLDP frames.

**Hardware Revisions** - Specifies hardware version.

**Firmware Revisions** - Specifies Firmware version.

**Software Revisions** - Specifies Software version.

**Serial Number** - Specifies serial number.

**Manufacturer Name** - Specifies manufacturers name.

**Model Name** - Specifies model name.

**Asset ID** - Specifies asset id.

**Location Information** - Specifies if location TLV is present in LLDP frames.

**Sub Type** - Specifies type of location information.

**Location Information** - Specifies the location information as a string for given type of location id

**Extended PoE** - Specifies if local device is a PoE device.

**Device Type** - Specifies power device type.

**Extended PoE PSE** - Specifies if extended PSE TLV is present in LLDP frame.

**Available** - Specifies available power sourcing equipment's power value in tenths of watts on the port of local device.

**Source** - Specifies power source of this port.

**Priority** - Specifies PSE port power priority.

**Extended PoE PD** - Specifies if extended PD TLV is present in LLDP frame.

**Required** - Specifies required power device power value in tenths of watts on the port of local device.

**Source** - Specifies power source of this port.

**Priority** - Specifies PD port power priority.

## Command Buttons

**Refresh** - Updates the information on the page.

LLDP-MED Local Device Information								
						Print	Reload	Help
Interface <span style="float: right;">0/1 ▼</span>								
Network Policies Information								
Network Application	VLAN ID	Priority	DSCP	Unknown Bit Status	Tagged Bit Status			
Voice	0	0	0	FALSE	FALSE			
Voice Signaling	0	0	0	FALSE	FALSE			
Guest Voice	0	0	0	FALSE	FALSE			
Guest Voice Signaling	0	0	0	FALSE	FALSE			
Soft Phone Voice	0	0	0	FALSE	FALSE			
Video Conferencing	0	0	0	FALSE	FALSE			
Streaming Video	0	0	0	FALSE	FALSE			
Video Signaling	0	0	0	FALSE	FALSE			
Refresh								

### 11.2.2.21.5. Configuring LLDP-MED Remote Device Information Page

#### Selection Criteria

**Local Interface** - Specifies the list of all the ports on which LLDP-MED is enabled.

#### Non-Configurable Data

**Capability Information** - Specifies the supported and enabled capabilities that was received in MED TLV on this port.

**Supported Capabilities** - Specifies supported capabilities that was received in MED TLV on this port.

**Enabled Capabilities** - Specifies enabled capabilities that was received in MED TLV on this port.

**Device Class** - Specifies device class as advertised by the device remotely connected to the port.

**Network Policy Information** - Specifies if network policy TLV is received in the LLDP frames on this port.

**Media Application Type** - Specifies the application type. Types of application types are unknown, voicesignaling, guestvoice, guestvoicesignalling, softphonevoice, videoconferencing, streamingvideo, vidoesignalling. Each application type that is received has the VLAN id, priority, DSCP, tagged bit status and unknown bit status. A port may receive one or many such application types. If a network policy TLV has been receive on this port only then would this information be displayed.

**VLAN Id** - Specifies the VLAN id associated with a particular policy type.

**Priority** - Specifies the priority associated with a particular policy type.

**DSCP** - Specifies the DSCP associated with a particular policy type.

**Unknown Bit Status** - Specifies the unknown bit associated with a particular policy type.

**Tagged Bit Status** - Specifies the tagged bit associated with a particular policy type.

**Inventory Information** - Specifies if location TLV is received in LLDP frames on this port.

**Hardware Revision** - Specifies hardware version of the remote device.

**Firmware Revision** - Specifies Firmware version of the remote device.

**Software Revision** - Specifies Software version of the remote device.

**Serial Number** - Specifies serial number of the remote device.

**Manufacturer Name** - Specifies manufacturers name of the remote device.

**Model Name** - Specifies model name of the remote device.

**Asset ID** - Specifies asset id of the remote device.

**Location Information** - Specifies if location TLV is received in LLDP frames on this port.

**Sub Type** - Specifies type of location information.

**Location Information** - Specifies the location information as a string for given type of location id.

**Extended PoE** - Specifies if remote device is a PoE device.

**Device Type** - Specifies remote device's PoE device type connected to this port.

**Extended PoE PSE** - Specifies if extended PSE TLV is received in LLDP frame on this port.

**Available** - Specifies the remote ports PSE power value in tenths of watts.

**Source** - Specifies the remote ports PSE power source.

**Priority** - Specifies the remote ports PSE power priority.

**Extended PoE PD** - Specifies if extended PD TLV is received in LLDP frame on this port.

**Required** - Specifies the remote port's PD power requirement.

**Source** - Specifies the remote port's PD power source.



**Priority** - Specifies the remote port's PD power priority.

### Command Buttons

**Refresh** - Updates the information on the page.

**LLDP-MED Remote Device Information**

 Print
  Reload
  Help

---

**Local Interface** 0/1

**Capability Information**

Supported Capabilities	Capabilities, Network Policy
Enabled Capabilities	Capabilities, Network Policy
Device Class	Endpoint Class III

**Display Network Policies**

Network Application	VLAN ID	Priority	DSCP	Unknown Bit Status	Tagged Bit Status
Voice	0	0	0	TRUE	FALSE
Voice Signaling	0	0	0	TRUE	FALSE
Guest Voice	0	0	0	TRUE	FALSE
Guest Voice Signaling	0	0	0	TRUE	FALSE
Soft Phone Voice	0	0	0	TRUE	FALSE
Video Conferencing	0	0	0	TRUE	FALSE
Streaming Video	0	0	0	TRUE	FALSE
Video Signaling	0	0	0	TRUE	FALSE

**Inventory Information**

- Hardware Revision
- Firmware Revision
- Software Revision
- Serial Number
- Manufacturer Name
- Model Name
- Asset ID

**Location Information**

<b>Sub Type</b>	<b>Location Information</b>
-----------------	-----------------------------

**Extended PoE**

- Device Type

## 11.2.2.22 Managing VTP

### 11.2.2.22.1. Configuring VTP Configuration Page

#### Configurable Data

**Admin Mode** - Enable or disable the VTP feature.

**Domain Name** - Set the name of the VTP administrative domain.

**Device Mode** - Use the pulldown menu to select the VTP device mode(client, server and transparent). The default operational mode of VTP device is "transparent".

**Pruning Mode** - Enable or disable the VTP pruning mode.

**Domain Password** - Set the password for the VTP administrative domain.

### Command Buttons

**Submit** - Applies the new configuration and causes the changes to take effect. These changes will not be retained across a power cycle unless a save configuration is performed.

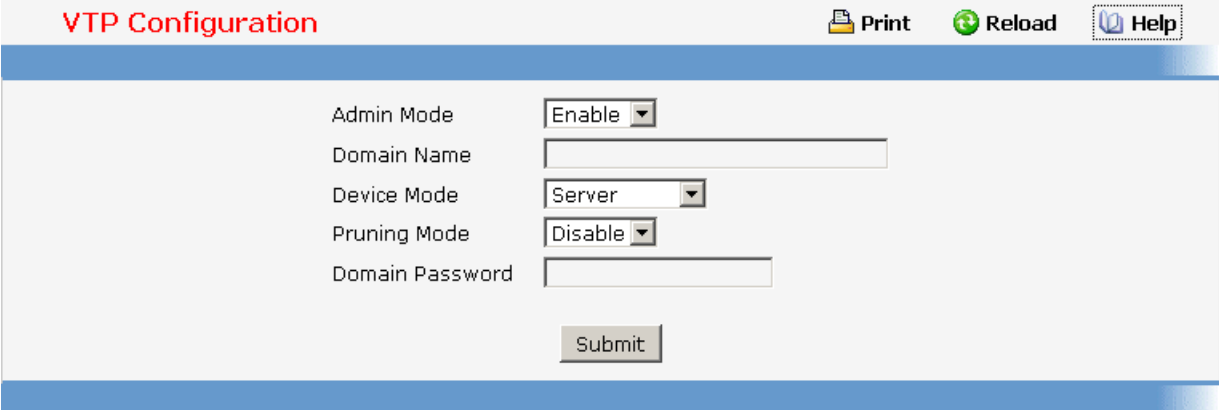

#### 11.2.2.22.2. Viewing VTP Status Page

##### Non-configurable data

**VTP Status** - Displays the VTP Status.

**Domain Name** - Displays VTP Domain Name.

**VTP Version** - Displays the VTP Version for the VTP domain status.

**Support VLAN number** - Displays the VLAN number for VTP.

**Maximum VTP supported VLANs** - The maximum VLANs supported for VTP.

**Device mode** - VTP operation mode.

**Pruning mode** - VTP Pruning mode.

**MD5 Digest** - Displays the MD5 Digest for the VTP domain status.

**Time Stamp** - Displays the VTP Time Stamp for the VTP domain status.

**Configuration Revision** - Displays the VTP Revision for the VTP domain status.

**Local updater ID** - Displays the Local updater ID for the VTP domain status.

VTP Summary										
VTP Status	Domain Name	VTP Version	Support VLAN number	Maximum VTP supported VLANs	Device Mode	Pruning Mode	MD5 Digest	Time Stamp	Configuration Revision	Link
Disable		128	5	64	VTPTransparent	Disable	0x3E 0x87 0x56 0x96 0xB2 0x7A 0xD5 0x5D		0	0.

## 11.2.3 Routing Menu

### 11.2.3.1 Managing ARP Table

#### 11.2.3.1.1. Creating ARP entries

Use this panel to add an entry to the Address Resolution Protocol table.

#### Configurable Data

**IP** - Specifies all the existing static ARP along with an additional option "Create". When the user selects "Create" another text boxes " IP Address" and "MAC Address" appear where the user may enter IP address and MAC address to be configured.

**IP Address** - Enter the IP address you want to add. It must be the IP address of a device on a subnet attached to one of the switch's existing routing interfaces.

**MAC Address** - The unicast MAC address of the device. Enter the address as six two-digit hexadecimal numbers separated by colons, for example 00:06:29:32:81:40.



#### Command Buttons

**Submit** - Update the switch with the values on this screen. If you want the switch to retain the new values across a power cycle, you must perform a save.

**Delete** - Allows the user to remove specified static entry from the ARP Table.

**Delete All** - Allows the user to remove all static entries from the ARP Table.

ARP Configuration

 Print
  Reload
  Help

IP Create ▾

IP Address

MAC Address

### 11.2.3.1.2. Configuring ARP Table

You can use this panel to change the configuration parameters for the Address Resolution Protocol Table. You can also use this screen to display the contents of the table.

#### Configurable Data

**Age Time (secs)**- Enter the value you want the switch to use for the ARP entry ageout time. You must enter a valid integer, which represents the number of seconds it will take for an ARP entry to age out. The range for this field is 15 to 21600 seconds. The default value for Age Time is 1200 seconds.

**Response Time (secs)** - Enter the value you want the switch to use for the ARP response timeout. You must enter a valid integer, which represents the number of seconds the switch will wait for a response to an ARP request. The range for this field is 1 to 10 seconds. The default value for Response Time is 1 second.

**Retries** - Enter an integer which specifies the maximum number of times an ARP request will be retried. The range for this field is 0 to 10. The default value for Retries is 4.

**Cache Size** - Enter an integer which specifies the maximum number of entries for the ARP cache. The range for this field is 256 to 3200. The default value for Cache Size is 3200.

**Dynamic Renew** - This controls whether the ARP component automatically attempts to renew ARP Entries of type Dynamic when they age out. The default setting is Enable.

**Remove from Table** - Allows the user to remove certain entries from the ARP Table. The choices listed specify the type of ARP Entry to be deleted:

- **All Dynamic Entries**
- **All Dynamic and Gateway Entries**
- **Specific Dynamic/Gateway Entry** - Selecting this allows the user to specify the required IP Address
- **Specific Static Entry** - Selecting this allows the user to specify the required IP Address
- **Specific Interface** - Selecting this allows the user to specify the required interface
- **None** - Selected if the user does not want to delete any entry from the ARP Table

**Remove IP Address** - This appears only if the user selects Specific Dynamic/Gateway Entry or Specific Static Entry in the Remove from Table Drop Down List. Allows the user to enter the IP Address against the entry that is to be removed from the ARP Table.

**Slot/Port** - The routing interface associated with the ARP entry.

### Non-Configurable Data

**Total Entry Count** - Total number of Entries in the ARP table.

**Peak Total Entries** - Highest value reached by Total Entry Count. This counter value is restarted whenever the ARP table Cache Size value is changed.

**Active Static Entries** - Total number of Active Static Entries in the ARP table.

**Configured Static Entries** - Total number of Configured Static Entries in the ARP table.

**Maximum Static Entries** - Maximum number of Static Entries that can be defined.

**IP Address** - The IP address of a device on a subnet attached to one of the switch's routing interfaces.

**MAC Address** - The unicast MAC address for the device. The format is six two-digit hexadecimal numbers separated by colons, for example 00:06:29:32:81:40.

**Slot/Port** - The routing interface associated with the ARP entry.

**Type** - The type of the ARP entry:



- **Local** - An ARP entry associated with one of the switch's routing interface's MAC addresses
- **Gateway** - A dynamic ARP entry whose IP address is that of a router
- **Static** - An ARP entry configured by the user
- **Dynamic** - An ARP entry which has been learned by the router

**Age** - Age since the entry was last refreshed in the ARP Table. The format is hh:mm:ss.

### Command Buttons

**Submit** - Update the switch with the values on this screen. If you want the switch to retain the new values across a power cycle, you must perform a save.

ARP Table Configuration

 Print
  Reload
  Help

---

Age Time (secs)	<input type="text" value="1200"/>	(15 to 21600)
Response Time (secs)	<input type="text" value="1"/>	(1 to 10)
Retries	<input type="text" value="4"/>	(0 to 10)
Cache Size	<input type="text" value="3968"/>	(384 to 3968)
Dynamic Renew	<input style="border: 1px solid #ccc; background-color: #f0f0f0; padding: 2px 5px;" type="button" value="Enable"/> ▾	
Total Entry Count	0	
Peak Total Entries	0	
Active Static Entries	0	
Configured Static Entries	0	
Maximum Static Entries	128	
Remove from Table	<input style="width: 100%; border: 1px solid #ccc;" type="text" value="None"/> ▾	

IP Address	MAC Address	Slot/Port	Type	Age
------------	-------------	-----------	------	-----

### 11.2.3.2 Managing IP Interfaces

#### 11.2.3.2.1. Configuring IP

Use this menu to configure routing parameters for the switch as opposed to an interface.

#### Configurable Data

**Routing Mode** - Select enable or disable from the pulldown menu. You must enable routing for the switch before you can route through any of the interfaces. The default value is disable.

**IP Forwarding Mode** - Select enable or disable from the pulldown menu. This enables or disables the forwarding of IP frames. The default value is enable.

#### Non-Configurable Data

**Default Time to Live** - The default value inserted into the Time-To-Live field of the IP header of datagrams originated by the switch, if a TTL value is not supplied by the transport layer protocol.

**Maximum Next Hops** - The maximum number of hops supported by the switch. This is a compile-time constant.

#### Command Buttons

**Submit** - Update the switch with the values on this screen. If you want the switch to retain the new values across a power cycle, you must perform a save.

**IP Configuration** Print Reload Help

Default Time to Live	64
Routing Mode	Enable
IP Forwarding Mode	Enable
Maximum Next Hops	2

#### 11.2.3.2.2. Viewing IP Statistics

The statistics reported on this panel are as specified in RFC 1213.

##### Non-Configurable Data

**IpInReceives** - The total number of input datagrams received from interfaces, including those received in error.

**IpInHdrErrors** - The number of input datagrams discarded due to errors in their IP headers, including bad checksums, version number mismatch, other format errors, time-to-live exceeded, errors discovered in processing their IP options, etc.

**IpInAddrErrors** - The number of input datagrams discarded because the IP address in their IP header's destination field was not a valid address to be received at this entity. This count includes invalid addresses (e.g., 0.0.0.0) and addresses of unsupported Classes (e.g., Class E). For entities which are not IP Gateways and therefore do not forward datagrams, this counter includes datagrams discarded because the destination address was not a local address.

**IpForwDatagrams** - The number of input datagrams for which this entity was not their final IP destination, as a result of which an attempt was made to find a route to forward them to that final destination. In entities which do not act as IP Gateways, this counter will include only those packets which were Source-Routed via this entity, and the Source-Route option processing was successful.

**IpInUnknownProtos** - The number of locally-addressed datagrams received successfully but discarded because of an unknown or unsupported protocol.

**IpInDiscards** - The number of input IP datagrams for which no problems were encountered to prevent their continued processing, but which were discarded (e.g., for lack of buffer space). Note that this counter does not include any datagrams discarded while awaiting re-assembly.

**IpInDelivers** - The total number of input datagrams successfully delivered to IP user-protocols (including ICMP).

**IpOutRequests** - The total number of IP datagrams which local IP user-protocols (including ICMP) supplied to IP in requests for transmission. Note that this counter does not include any datagrams counted in ipForwDatagrams.

**IpOutDiscards** - The number of output IP datagrams for which no problem was encountered to prevent their transmission to their destination, but which were discarded (e.g., for lack of buffer space). Note that this counter would include datagrams counted in ipForwDatagrams if any such packets met this (discretionary) discard criterion.

**IpNoRoutes** - The number of IP datagrams discarded because no route could be found to transmit them to their destination. Note that this counter includes any packets counted in ipForwDatagrams which meet this 'no-route' criterion. Note that this includes any datagrams which a host cannot route because all of its default gateways are down.

**IpReasmTimeout** - The maximum number of seconds which received fragments are held while they are awaiting reassembly at this entity.

**IpReasmReqds** - The number of IP fragments received which needed to be reassembled at this entity.

**IpReasmOKs** - The number of IP datagrams successfully re-assembled.

**IpReasmFails** - The number of failures detected by the IP re-assembly algorithm (for whatever reason: timed out, errors, etc). Note that this is not necessarily a count of discarded IP fragments since some algorithms can lose track of the number of fragments by combining them as they are received.

**IpFragOKs** - The number of IP datagrams that have been successfully fragmented at this entity.

**IpFragFails** - The number of IP datagrams that have been discarded because they needed to be fragmented at this entity but could not be, e.g., because their Don't Fragment flag was set.

**IpFragCreates** - The number of IP datagram fragments that have been generated as a result of fragmentation at this entity.

**IpRoutingDiscards** - The number of routing entries which were chosen to be discarded even though they are valid. One possible reason for discarding such an entry could be to free-up buffer space for other routing entries.

**IcmpInMsgs** - The total number of ICMP messages which the entity received. Note that this counter includes all those counted by icmpInErrors.

**IcmpInErrors** - The number of ICMP messages which the entity received but determined as having ICMP-specific errors (bad ICMP checksums, bad length, etc.).



**IcmpInDestUnreachs** - The number of ICMP Destination Unreachable messages received.

**IcmpInTimeExcds** - The number of ICMP Time Exceeded messages received.

**IcmpInParmProbs** - The number of ICMP Parameter Problem messages received.

**IcmpInSrcQuenchs** - The number of ICMP Source Quench messages received.

**IcmpInRedirects** - The number of ICMP Redirect messages received.

**IcmpInEchos** - The number of ICMP Echo (request) messages received.

**IcmpInEchoReps** - The number of ICMP Echo Reply messages received.

**IcmpInTimestamps** - The number of ICMP Timestamp (request) messages received.

**IcmpInTimestampReps** - The number of ICMP Timestamp Reply messages received.

**IcmpInAddrMasks** - The number of ICMP Address Mask Request messages received.

**IcmpInAddrMaskReps** - The number of ICMP Address Mask Reply messages received.

**IcmpOutMsgs** - The total number of ICMP messages which this entity attempted to send. Note that this counter includes all those counted by icmpOutErrors.

**IcmpOutErrors** - The number of ICMP messages which this entity did not send due to problems discovered within ICMP such as a lack of buffers. This value should not include errors discovered outside the ICMP layer such as the inability of IP to route the resultant datagram. In some implementations there may be no types of error which contribute to this counter's value.

**IcmpOutDestUnreachs** - The number of ICMP Destination Unreachable messages sent.

**IcmpOutTimeExcds** - The number of ICMP Time Exceeded messages sent.

**IcmpOutParmProbs** - The number of ICMP Parameter Problem messages sent.

**IcmpOutSrcQuenchs** - The number of ICMP Source Quench messages sent.

**IcmpOutRedirects** - The number of ICMP Redirect messages sent. For a host, this object will always be zero, since hosts do not send redirects.

**IcmpOutEchos** - The number of ICMP Echo (request) messages sent.

**IcmpOutEchoReps** - The number of ICMP Echo Reply messages sent.

**IcmpOutTimestamps** - The number of ICMP Timestamp (request) messages.

**IcmpOutTimestampReps** - The number of ICMP Timestamp Reply messages sent.

**IcmpOutAddrMasks** - The number of ICMP Address Mask Request messages sent.

**IcmpOutAddrMaskReps** - The number of ICMP Address Mask Reply messages sent.

### Command Buttons

**Refresh** - Refresh the data on the screen with the present state of the data in the switch.

IP Statistics		Print	Reload	Help
IpInReceives	17890			
IpInHdrErrors	0			
IpInAddrErrors	511			
IpForwDatagrams	0			
IpInUnknownProtos	0			
IpInDiscards	0			
IpInDelivers	17381			
IpOutRequests	16555			
IpOutDiscards	0			
IpOutNoRoutes	0			
IpReasmTimeout	0			
IpReasmReqds	0			
IpReasmOKs	0			
IpReasmFails	0			
IpFragOKs	0			
IpFragFails	0			
IpFragCreates	0			
IpRoutingDiscards	0			
IcmpInMsgs	0			
IcmpInErrors	0			
IcmpInDestUnreachs	0			
IcmpInTimeExcds	0			
IcmpInParmProbs	0			
IcmpInSrcQuenchs	0			
IcmpInRedirects	0			
IcmpInEchos	0			
IcmpInEchoReps	0			
IcmpInTimestamps	0			

IcmpInTimestampReps	0
IcmpInAddrMasks	0
IcmpInAddrMaskReps	0
IcmpOutMsgs	0
IcmpOutErrors	0
IcmpOutDestUnreachs	0
IcmpOutTimeExcds	0
IcmpOutParmProbs	0
IcmpOutSrcQuenchs	0
IcmpOutRedirects	0
IcmpOutEchos	0
IcmpOutEchoReps	0
IcmpOutTimestamps	0
IcmpOutTimestampReps	0
IcmpOutAddrMasks	0
IcmpOutAddrMaskReps	0

### 11.2.3.2.3. Configuring IP Interfaces

#### Selection Criteria

**Slot/Port** - Select the interface for which data is to be displayed or configured.

#### Configurable Data

**IP Address** - Enter the IP address for the interface.

**Subnet Mask** - Enter the subnet mask for the interface. This is also referred to as the subnet/network mask, and defines the portion of the interface's IP address that is used to identify the attached network.

**Routing Mode** - Setting this enables or disables routing for an interface. The default value is enable.

**Administrative Mode** - The Administrative Mode of the interface. The default value is enable.

**Forward Net Directed Broadcasts** - Select how network directed broadcast packets should be handled. If you select enable from the pulldown menu network directed broadcasts will be forwarded. If you select disable they will be dropped. The default value is disable.

**Encapsulation Type** - Select the link layer encapsulation type for packets transmitted from the specified interface from the pulldown menu. The possible values are Ethernet and SNAP. The default is Ethernet.

**Proxy Arp** - Select to disable or enable proxy Arp for the specified interface from the pulldown menu.

**Local Proxy Arp** - Select to disable or enable Local Proxy ARP for the specified interface from the pulldown menu.

**IP MTU** - Specifies the maximum transmission unit (MTU) size of IP packets sent on an interface. Valid range is (68 to 1500). Default value is 1500.

### Non-Configurable Data

**Active State** - The state of the specified interface is either Active or Inactive. An interface is considered active if it the link is up and it is in forwarding state.

**MAC Address** - The burned-in physical address of the specified interface. The format is six two-digit hexadecimal numbers separated by colons, for example 00:06:29:32:81:40.



### Command Buttons

**Submit** - Update the switch with the values on this screen. If you want the switch to retain the new values across a power cycle, you must perform a save.

**Delete IP Address** - Delete the IP Address from the interface. Note that the address can not be deleted if there are secondary addresses configured.

**Secondary IP Address** - Proceed to the Secondary IP Address configuration screen.

IP Interface Configuration

 **Print**   
  **Reload**   
  **Help**

Slot/Port	0/1 ▾
IP Address	0.0.0.0
Subnet Mask	0.0.0.0
Routing Mode	Disable ▾
Administrative Mode	Enable ▾
Link Speed Data Rate	10000 Full
Forward Net Directed Broadcasts	Disable ▾
Active State	Active
MAC Address	00:C0:9F:11:22:9B
Encapsulation Type	Ethernet ▾
Proxy Arp	Enable ▾
Local Proxy Arp	Disable ▾
IP MTU	1500 (68 to 1500)

### 11.2.3.3 Managing OSPF

### 11.2.3.3.1. Configuring OSPF

#### Configurable Data

**Router ID** - The 32 bit integer in dotted decimal format that uniquely identifies the router within the autonomous system (AS). If you want to change the Router ID you must first disable OSPF. After you set the new Router ID, you must re-enable OSPF to have the change take effect. The default value is 0.0.0.0, although this is not a valid Router ID.

**OSPF Admin Mode\*** - Select enable or disable from the pulldown menu. If you select enable OSPF will be activated for the switch. The default value is disable. You must configure a Router ID before OSPF can become operational. You do this on the IP Configuration page or by issuing the CLI command: config router id.

**\*NOTE: once OSPF is initialized on the router, it will remain initialized until the router is reset.**

**RFC 1583 Compatibility** - Select enable or disable from the pulldown menu to specify the preference rules that will be used when choosing among multiple AS-external-LSAs advertising the same destination. If you select enable, the preference rules will be those defined by RFC 1583. If you select disable, the preference rules will be those defined in Section 16.4.1 of the OSPF-2 standard (RFC 2328), which will prevent routing loops when AS-external-LSAs for the same destination have been originated from different areas. The default value is 'enable'. To prevent routing loops, you should select 'disable', but only if all OSPF routers in the routing domain are capable of operating according to RFC 2328.

**Exit Overflow Interval (secs)**- Enter the number of seconds that, after entering overflow state, the router should wait before attempting to leave overflow state. This allows the router to again originate non-default AS-external-LSAs. If you enter 0, the router will not leave Overflow State until restarted. The range is 0 to 2147483647 seconds.

**SPF DelayTime(secs)** - Enter the number of seconds, Delay time (in seconds) is the time between when OSPF receives a topology change and when it starts an SPF calculation. It can be an integer from 0 to 65535. The default time is 5 seconds. A value of 0 means that there is no delay; that is, the SPF calculation is started immediately.

**SPF HoldTime(secs)** - Enter the number of seconds, minimum time (in seconds) between two consecutive SPF calculations. It can be an integer from 0 to 65535. The default time is 10 seconds. A value of 0 means that there is no delay; that is, two SPF calculations can be done, one immediately after the other.

**Default Metric** - Sets a default for the metric of redistributed routes. This field displays the default metric if one has already been set or blank if not configured earlier. The valid values are (1 to 16777215)

**Maximum Paths** - Sets the maximum number of paths that OSPF can report for a given destination. The valid values are (1 to 6).

**Default Information Originate** - Enable or Disable Default Route Advertise.

**Always** - Sets the router advertise 0.0.0.0/0.0.0.0 when set to "True".

**Metric** - Specifies the metric of the default route. The valid values are (0 to 16777215)

**Metric Type** - Sets the metric type of the default route.

### Non-Configurable Data

**ASBR Mode** - Reflects whether the ASBR mode is enabled or disabled. Enable implies that the router is an autonomous system border router. Router automatically becomes an ASBR when it is configured to redistribute routes learnt from other protocol.

**ABR Status** - The values of this are enabled or disabled. Enabled implies that the router is an area border router. Disabled implies that it is not an area border router.

**External LSA Count** - The number of external (LS type 5) LSAs (link state advertisements) in the link state database.

**External LSA Checksum** - The sum of the LS checksums of the external LSAs (link state advertisements) contained in the link-state database. This sum can be used to determine if there has been a change in a router's link state database, and to compare the link-state databases of two routers.



**New LSAs Originated** - In any given OSPF area, a router will originate several LSAs. Each router originates a router-LSA. If the router is also the Designated Router for any of the area's networks, it will originate network-LSAs for those networks. This value represents the number of LSAs originated by this router.

**LSAs Received** - The number of LSAs (link state advertisements) received that were determined to be new instantiations. This number does not include newer instantiations of self-originated LSAs.

### Command Buttons

**Submit** - Send the updated configuration to the switch. Configuration changes take effect immediately. These changes will not be retained across a power cycle unless a save is performed.

OSPF Configuration

 Print
  Reload
  Help

---

Router ID	<input type="text" value="1.1.1.1"/>	
OSPF Admin Mode	<input type="button" value="Enable"/>	
ASBR Mode	Enabled	
RFC 1583 Compatibility	<input type="button" value="Enable"/>	
ABR Status	Disabled	
Exit Overflow Interval (secs)	<input type="text" value="0"/>	(0 to 2147483647)
SPF DelayTime(secs)	<input type="text" value="5"/>	(0 to 65535)
SPF HoldTime(secs)	<input type="text" value="10"/>	(0 to 65535)
External LSA Count	0	
External LSA Checksum	0	
New LSAs Originated	7	
LSAs Received	3	
Default Metric	<input type="text"/>	(1 to 16777214)
Maximum Paths	<input type="text" value="2"/>	(1 to 2)
Default Route Advertise		
Default Information Originate	<input type="button" value="Disable"/>	
Always	<input type="button" value="False"/>	
Metric	<input type="text"/>	(0 to 16777214)
Metric Type	<input type="button" value="External Type 2"/>	
<input type="button" value="Submit"/>		

### 11.2.3.3.2. Configuring Area

#### Selection Criteria

**Area ID** - Select the area to be configured.

#### Configurable Data

**Import Summary LSAs** - Select enable or disable from the pulldown menu. If you select enable summary LSAs will be imported into stub areas.

**Metric Value** - Enter the metric value you want applied for the default route advertised into the stub area. Valid values range from 1 to 16,777,215.

**Metric Type** - Select the type of metric specified in the Metric Value field.

- **OSPF Metric** - Regular OSPF metric
- **Comparable Cost** - External Type 1 metrics that are comparable to the OSPF metric
- **Non-comparable Cost** - External Type 2 metrics that are assumed to be larger than the cost of the OSPF metric

**Translator Role** - Select Always or Candidate from the pulldown menu. A value of always will cause the router to assume the role of the translator when it becomes a border router and a value of candidate will cause the router to participate in the translator election process when it attains border router status.

**Translator Stability Interval** - Enter the translator stability interval of the NSSA. The stability interval is the period of time that an elected translator continues to perform its duties after it determines that its translator status has been deposed by another router. Valid values range from 0 to 3600.

**No-Redistribute Mode** - Select enable or disable from the pulldown menu. If you select enable learned external routes will not be redistributed to the NSSA.

### Non-Configurable Data

**Area ID** - The OSPF area. An Area ID is a 32 bit integer in dotted decimal format that uniquely identifies the area to which a router interface connects.

**External Routing** - A definition of the router's capabilities for the area, including whether or not AS-external-LSAs are flooded into/throughout the area. If the area is a stub area, then these are the possible options for which you may configure the external routing capability, otherwise the only option is "Import External LSAs".

- **Import External LSAs** - Import and propagate external LSAs
- **Import No LSAs** - Do not import and propagate external LSAs

**SPF Runs** - The number of times that the intra-area route table has been calculated using this area's link-state database. This is typically done using Dijkstra's algorithm.

**Area Border Router Count** - The total number of area border routers reachable within this area. This is initially zero, and is calculated in each SPF Pass.

**Area LSA Count** - The total number of link-state advertisements in this area's link-state database, excluding AS External LSAs.

**Area LSA Checksum** - The 32-bit unsigned sum of the link-state advertisements' LS checksums contained in this area's link-state database. This sum excludes external (LS type 5) link-state advertisements. The sum can be used to determine if there has been a change in a router's link state database, and to compare the link-state database of two routers.

**Interface Mode** - This field tells you whether the area is or is not a stub area. If the area may be a stub area, a 'Create Stub Area' button will be displayed. If you have configured the area as a stub area a 'Delete Stub Area' button will be displayed. Otherwise neither button will be displayed.

### Command Buttons

**Create Stub Area** - Configure the area as a stub area.





**Delete Stub Area** - Delete the stub area designation. The area will be returned to normal state.

**Create NSSA** - Configure the area as a NSSA

**Delete NSSA** - Delete the NSSA. The area will be returned to normal state.

**Submit** - Send the updated configuration to the switch. Configuration changes take effect immediately. These changes will not be retained across a power cycle unless a save is performed.

OSPF Area Configuration

 Print
  Reload
  Help

Area	0.0.0.1
Area ID	0.0.0.1
External Routing	Import External LSAs
SPF Runs	0
Area Border Router Count	0
Area LSA Count	0
Area LSA Checksum	0
<b>Stub Area Information</b>	
Interface Mode	None
<div style="display: flex; justify-content: center; gap: 10px;"> <span style="border: 1px solid #ccc; padding: 5px 15px; background-color: #f0f0f0;">Create Stub Area</span> <span style="border: 1px solid #ccc; padding: 5px 15px; background-color: #f0f0f0;">Create NSSA</span> <span style="border: 1px solid #ccc; padding: 5px 15px; background-color: #f0f0f0;">Submit</span> </div>	

### 11.2.3.3.3. Viewing Stub Area Summary Information

#### Non-Configurable Data

**Area ID** - The Area ID of the Stub area

**Type of Service** - The type of service associated with the stub metric. The switch supports Normal only.

**Metric Value** - Set the metric value you want applied for the default route advertised into the area. Valid values range from 1 to 16,777,215.

**Import Summary LSAs** - Whether the import of Summary LSAs is enabled or disabled.

#### Command Buttons

**Refresh** - Refresh the data on the screen to the current values from the switch.

OSPF Stub Area Summary			
Area ID	Type of Service	Metric Value	Import Summary LSAs
0.0.0.1	Normal	1	Enable
<input type="button" value="Refresh"/>			

#### 11.2.3.3.4. Configuring Area Range

##### Selection Criteria

**Area ID** - Selects the area for which data is to be configured.

##### Configurable Data

**IP address** - Enter the IP Address for the address range for the selected area.

**Subnet Mask** - Enter the Subnet Mask for the address range for the selected area.

**LSDB Type** - Select the type of Link Advertisement associated with the specified area and address range. The default type is 'Network Summary'.

**Advertisement** - Select enable or disable from the pulldown menu. If you selected enable the address range will be advertised outside the area via a Network Summary LSA. The default is enable.

##### Non-Configurable Data

**Area ID** - The OSPF area.

**IP address** - The IP Address of an address range for the area.

**Subnet Mask** - The Subnet Mask of an address range for the area.

**LSDB Type** - The Link Advertisement type for the address range and area.



**Advertisement** - The Advertisement mode for the address range and area.

##### Command Buttons

**Create** - Send the updated configuration to the switch. Configuration changes take effect immediately. These changes will not be retained across a power cycle unless a save is performed. The new address range will be added to the display in the non-configurable data area.

**Delete** - Removes the specified address range from the area configuration.

OSPF Area Range Configuration

 Print
  Reload
  Help

Area ID	IP Address	Subnet Mask	LSDB Type	Advertisement
0.0.0.0			Network Summary	Enable
Area ID	IP Address	Subnet Mask	LSDB Type	Advertisement

Create
Delete
Delete Area

### 11.2.3.3.5. View Interface Statistics

This panel displays statistics for the selected interface. The information will be displayed only if OSPF is enabled.

#### Selection Criteria

**Slot/Port** - Select the interface for which data is to be displayed.

#### Non-Configurable Data

**OSPF Area ID** - The OSPF area to which the selected router interface belongs. An OSPF Area ID is a 32 bit integer in dotted decimal format that uniquely identifies the area to which the interface connects.

**Area Border Router Count** - The total number of area border routers reachable within this area. This is initially zero, and is calculated in each SPF Pass.

**AS Border Router Count** - The total number of Autonomous System border routers reachable within this area. This is initially zero, and is calculated in each SPF Pass.

**Area LSA Count** - The total number of link-state advertisements in this area's link-state database, excluding AS External LSAs.

**IP Address** - The IP address of the interface.

**Interface Events** - The number of times the specified OSPF interface has changed its state, or an error has occurred.

**Virtual Events** - The number of state changes or errors that have occurred on this virtual link.



**Neighbor Events** - The number of times this neighbor relationship has changed state, or an error has occurred.

**External LSA Count** - The number of external (LS type 5) link-state advertisements in the link-state database.

#### Command Buttons

**Refresh** - Refresh the data on the screen with the present state of the data in the switch.

OSPF Interface Statistics

 Print
  Reload
  Help

---

Slot/Port	0/3 ▾
OSPF Area ID	0.0.0.0
Area Border Router Count	0
AS Border Router Count	1
Area LSA Count	3
IP Address	192.168.101.54
Interface Events	2
Virtual Events	0
Neighbor Events	5
External LSA Count	0

### 11.2.3.3.6. Configuring OSPF Interface

#### Selection Criteria

**Slot/Port** - Select the interface for which data is to be displayed or configured.

#### Configurable Data

**OSPF Admin Mode\*** - You may select enable or disable from the pulldown menu. The default value is 'disable.' You can configure OSPF parameters without enabling OSPF Admin Mode, but they will have no effect until you enable Admin Mode. The following information will be displayed only if the Admin Mode is enabled: State, Designated Router, Backup Designated Router, Number of Link Events, LSA Ack Interval, and Metric Cost. For OSPF to be fully functional, you must enter a valid IP Address and Subnet Mask via the Interface IP Configuration page or through the CLI command: `config ip interface network .`

**\*NOTE: once OSPF is initialized on the router, it will remain initialized until the router is reset.**

**OSPF Area ID** - Enter the 32 bit integer in dotted decimal format that uniquely identifies the OSPF area to which the selected router interface connects. If you assign an Area ID which does not exist, the area will be created with default values.

**Router Priority** - Enter the OSPF priority for the selected interface. The priority of an interface is specified as an integer from 0 to 255. The default is 1, which is the highest router priority. A value of '0' indicates that the router is not eligible to become the designated router on this network

**Retransmit Interval (secs)**- Enter the OSPF retransmit interval for the specified interface. This is the number of seconds between link-state advertisements for adjacencies belonging to this router interface. This value is also used when retransmitting database descriptions and link-state request packets. Valid values range from 1 to 3600 seconds (1 hour). The default is 5 seconds.

**Hello Interval (secs)**- Enter the OSPF hello interval for the specified interface in seconds. This parameter must be the same for all routers attached to a network. Valid values range from 1 to 65,535. The default is 10 seconds.

**Dead Interval (secs)**- Enter the OSPF dead interval for the specified interface in seconds. This specifies how long a router will wait to see a neighbor router's Hello packets before declaring that the router is down. This parameter must be the same for all routers attached to a network. This value should be a multiple of the Hello Interval (e.g. 4). Valid values range from 1 to 2147483647. The default is 40.

**Iftransit Delay Interval (secs)**- Enter the OSPF Transit Delay for the specified interface. This specifies the estimated number of seconds it takes to transmit a link state update packet over the selected interface. Valid values range from 1 to 3600 seconds (1 hour). The default value is 1 second.

**MTU Ignore** - Disables OSPF MTU mismatch detection on receiving packets. Default value is Disable.

**Authentication Type** - You may select an authentication type other than none by clicking on the 'Configure' button. You will then see a new screen, where you can select the authentication type from the pulldown menu. The choices are:

- **None** - This is the initial interface state. If you select this option from the pulldown menu on the second screen you will be returned to the first screen and no authentication protocols will be run.
- **Simple** - If you select 'Simple' you will be prompted to enter an authentication key. This key will be included, in the clear, in the OSPF header of all packets sent on the network. All routers on the network must be configured with the same key.
- **Encrypt** - If you select 'Encrypt' you will be prompted to enter both an authentication key and an authentication ID. Encryption uses the MD5 Message-Digest algorithm. All routers on the network must be configured with the same key and ID.

**Authentication Key** - Enter the OSPF Authentication Key for the specified interface. If you do not choose to use authentication you will not be prompted to enter a key. If you choose 'simple' authentication you cannot use a key of more than 8 octets. If you choose 'encrypt' the key may be up to 16 octets long. The key value will only be displayed if you are logged on with Read/Write privileges, otherwise it will be displayed as asterisks.

**Authentication Key ID** - Enter the ID to be used for authentication. You will only be prompted to enter an ID when you select 'Encrypt' as the authentication type. The ID is a number between 0 and 255, inclusive.

**Metric Cost** - Enter the value on this interface for the cost TOS (type of service). The range for the metric cost is between 1 and 65,535. Metric Cost is only configurable/displayed if OSPF is initialized on the interface.

## Non-Configurable Data

**IP Address** - The IP address of the interface.

**Subnet Mask** - The subnet/network mask, that indicates the portion of the IP interface address that identifies the attached network.

**LSA Ack Interval** - The number of seconds between LSA Acknowledgment packet transmissions, which must be less than the Retransmit Interval.

**OSPF Interface Type** - The OSPF interface type, which will always be broadcast.

**State** - The current state of the selected router interface. One of:

- **Down** - This is the initial interface state. In this state, the lower-level protocols have indicated that the interface is unusable. In this state, interface parameters will be set to their initial values. All interface timers will be disabled, and there will be no adjacencies associated with the interface.
- **Loopback** - In this state, the router's interface to the network is looped back either in hardware or software. The interface is unavailable for regular data traffic. However, it may still be desirable to gain information on the quality of this interface, either through sending ICMP pings to the interface or through something like a bit error test. For this reason, IP packets may still be addressed to an interface in Loopback state. To facilitate this, such interfaces are advertised in router- LSAs as single host routes, whose destination is the IP interface address.
- **Waiting** - The router is trying to determine the identity of the (Backup) Designated Router for the network by monitoring received Hello Packets. The router is not allowed to elect a Backup Designated Router or a Designated Router until it transitions out of Waiting state. This prevents unnecessary changes of (Backup) Designated Router.
- **Designated Router** - This router is itself the Designated Router on the attached network. Adjacencies are established to all other routers attached to the network. The router must also originate a network-LSA for the network node. The network- LSA will contain links to all routers (including the Designated Router itself) attached to the network.
- **Backup Designated Router** - This router is itself the Backup Designated Router on the attached network. It will be promoted to Designated Router if the present Designated Router fails. The router establishes adjacencies to all other routers attached to the network. The Backup Designated Router performs slightly different functions during the Flooding Procedure, as compared to the Designated Router.
- **Other Designated Router** - The interface is connected to a broadcast or NBMA network on which other routers have been selected to be the Designated Router and Backup Designated Router either. The router attempts to form adjacencies to both the Designated Router and the Backup Designated Router.

The State is only displayed if the OSPF admin mode is enabled.

**Designated Router** - The identity of the Designated Router for this network, in the view of the advertising router. The Designated Router is identified here by its router ID. The value 0.0.0.0 means that there is no Designated Router. This field is only displayed if the OSPF admin mode is enabled.

**Backup Designated Router** - The identity of the Backup Designated Router for this network, in the view of the advertising router. The Backup Designated Router is identified here by its router ID. Set to 0.0.0.0 if there is no Backup Designated Router. This field is only displayed if the OSPF admin mode is enabled.



**Number of Link Events** - This is the number of times the specified OSPF interface has changed its state. This field is only displayed if the OSPF admin mode is enabled.

### Command Buttons

**Configure Authentication** - Display a new screen where you can select the authentication method for the virtual link.

**Submit** - Send the updated configuration to the switch. Configuration changes take effect immediately. These changes will not be retained across a power cycle unless a save is performed.

OSPF Interface Configuration

 Print
  Reload
  Help

Slot/Port	<input type="text" value="0/1"/>	
IP Address	<input type="text" value="192.168.101.54"/>	
Subnet Mask	<input type="text" value="255.255.255.0"/>	
OSPF Admin Mode	<input type="text" value="Enable"/>	
OSPF Area ID	<input type="text" value="0.0.0.0"/>	
Router Priority	<input type="text" value="1"/> (0 to 255)	
Retransmit Interval (secs)	<input type="text" value="5"/> (0 to 3600)	
Hello Interval (secs)	<input type="text" value="10"/> (1 to 65535)	
Dead Interval (secs)	<input type="text" value="40"/> (1 to 2147483647)	
LSA Ack Interval (secs)	<input type="text" value="1"/>	
Iftransit Delay Interval (secs)	<input type="text" value="1"/> (1 to 3600)	
MTU Ignore	<input type="text" value="Disable"/>	
Authentication Type	<input type="text" value="None"/> <input type="button" value="Configure"/>	
Interface Type	<input type="text" value="Broadcast"/>	
State	<input type="text" value="Designated-Router"/>	
Designated Router	<input type="text" value="1.1.1.1"/>	
Backup Designated Router	<input type="text" value="200.0.0.0"/>	
Number of Link Events	<input type="text" value="2"/>	
Metric Cost	<input type="text" value="1"/> (1 to 65535)	

### 11.2.3.3.7. Viewing Neighbor Table Information

This panel displays the OSPF neighbor table list. When a particular neighbor ID is specified, detailed information about a neighbor is given. The information below will only be displayed if

OSPF is enabled.

### Selection Criteria

**Slot/Port** - Selects the interface for which data is to be displayed or configured. Slot 0 is the base unit.

### Non-Configurable Data

**Router ID** - A 32 bit integer in dotted decimal format representing the neighbor interface.

**IP Address** - The IP address of the neighboring router's interface to the attached network. It is used as the destination IP address when protocol packets are sent as unicasts along this adjacency. Also used in router-LSAs as the Link ID for the attached network if the neighboring router is selected to be designated router. The Neighbor IP address is learned when Hello packets are received from the neighbor. For virtual links, the Neighbor IP address is learned during the routing table build process.

**Neighbor Interface Index** - A Slot/Port identifying the neighbor interface index.

### Command Buttons

**Refresh** - Refresh the data on the screen with the present state of the data in the switch.

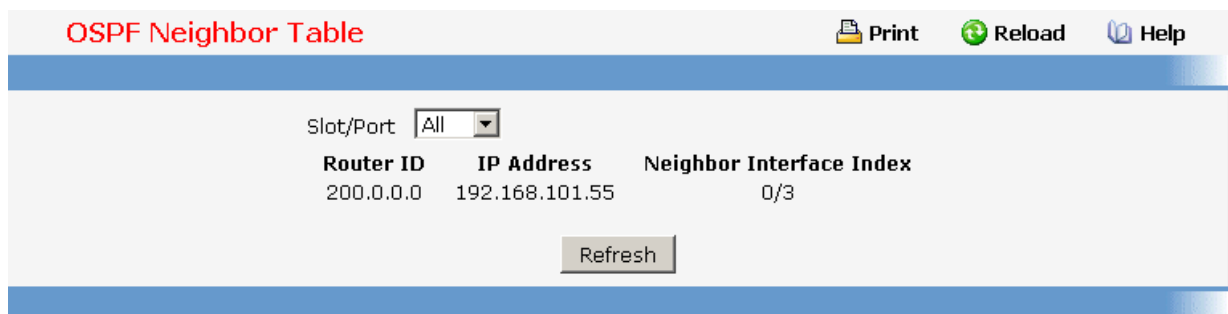

**OSPF Neighbor Table** Print Reload Help

Slot/Port:

Router ID	IP Address	Neighbor Interface Index
200.0.0.0	192.168.101.55	0/3

#### 11.2.3.3.8. Configuring OSPF Neighbor

This panel displays the OSPF neighbor configuration for a selected neighbor ID. When a particular neighbor ID is specified, detailed information about a neighbor is given. The information below will only be displayed if OSPF is enabled and the interface has a neighbor. The IP address is the IP address of the neighbor.

### Selection Criteria

**Slot/Port** - Selects the interface for which data is to be displayed or configured. Slot 0 is the base unit.

**Neighbor IP Address** - Selects the IP Address of the neighbor for which data is to be displayed.

### Non-Configurable Data



**Router ID** - A 32 bit integer in dotted decimal format that identifies the neighbor router.

**Options** - The optional OSPF capabilities supported by the neighbor. The neighbor's optional OSPF capabilities are also listed in its Hello packets. This enables received Hello Packets to be rejected (i.e., neighbor relationships will not even start to form) if there is a mismatch in certain crucial OSPF capabilities.

**Router Priority** - Displays the OSPF priority for the specified neighbor. The priority of a neighbor is a priority integer from 0 to 255. A value of '0' indicates that the router is not eligible to become the designated router on this network.

**State** - The state of a neighbor can be the following:

- **Down** - This is the initial state of a neighbor conversation. It indicates that there has been no recent information received from the neighbor. On NBMA networks, Hello packets may still be sent to "Down" neighbors, although at a reduced frequency.
- **Attempt** - This state is only valid for neighbors attached to NBMA networks. It indicates that no recent information has been received from the neighbor, but that a more concerted effort should be made to contact the neighbor. This is done by sending the neighbor Hello packets at intervals of Hello Interval.
- **Init** - In this state, a Hello packet has recently been seen from the neighbor. However, bidirectional communication has not yet been established with the neighbor (i.e., the router itself did not appear in the neighbor's Hello packet). All neighbors in this state (or greater) are listed in the Hello packets sent from the associated interface.
- **2-Way** - In this state, communication between the two routers is bidirectional. This has been assured by the operation of the Hello Protocol. This is the most advanced state short of beginning adjacency establishment. The (Backup) Designated Router is selected from the set of neighbors in state 2-Way or greater.
- **Exchange Start** - This is the first step in creating an adjacency between the two neighboring routers. The goal of this step is to decide which router is the master, and to decide upon the initial DD sequence number. Neighbor conversations in this state or greater are called adjacencies.
- **Exchange** - In this state the router is describing its entire link state database by sending Database Description packets to the neighbor. In this state, Link State Request Packets may also be sent asking for the neighbor's more recent LSAs. All adjacencies in Exchange state or greater are used by the flooding procedure. These adjacencies are fully capable of transmitting and receiving all types of OSPF routing protocol packets.
- **Loading** - In this state, Link State Request packets are sent to the neighbor asking for the more recent LSAs that have been discovered (but not yet received) in the Exchange state.
- **Full** - In this state, the neighboring routers are fully adjacent. These adjacencies will now appear in router-LSAs and network-LSAs.

**Events** - The number of times this neighbor relationship has changed state, or an error has occurred.

**Permanence** - This variable displays the status of the entry. 'dynamic' and 'permanent' refer to how the neighbor became known.



**Hellos Suppressed** - This indicates whether Hellos are being suppressed to the neighbor.

**Retransmission Queue Length** - The current length of the retransmission queue.

### Command Buttons

**Refresh** - Refresh the data on the screen with the present state of the data in the switch.

OSPF Neighbor Configuration

 Print
  Reload
  Help

Slot/Port	0/1 ▾
Neighbor IP Address	192.168.101.55 ▾
Router ID	200.0.0.0
Options	2
Router Priority	1
State	Full
Events	5
Permanence	Dynamic
Hellos Suppressed	No
Retransmission Queue Length	0

### 11.2.3.3.9. Viewing OSPF Link State Database

#### Non-Configurable Data

**Router ID** - The 32 bit integer in dotted decimal format that uniquely identifies the router within the autonomous system (AS). The Router ID is set on the IP Configuration page. If you want to change the Router ID you must first disable OSPF. After you set the new Router ID, you must re-enable OSPF to have the change take effect. The default value is 0.0.0.0, although this is not a valid Router ID.

**Area ID** - The ID of an OSPF area to which one of the router interfaces is connected. An Area ID is a 32 bit integer in dotted decimal format that uniquely identifies the area to which an interface is connected.

**LSA Type** - The format and function of the link state advertisement. One of the following:

- ***Router Links***
- ***Network Links***
- ***Network Summary***
- ***ASBR Summary***
- ***AS-external***

**LS ID** - The Link State ID identifies the piece of the routing domain that is being described by the advertisement. The value of the LS ID depends on the advertisement's LS type.

**Age** - The time since the link state advertisement was first originated, in seconds.

**Sequence** - The sequence number field is a signed 32-bit integer. It is used to detect old and duplicate link state advertisements. The larger the sequence number, the more recent the advertisement.

**Checksum** - The checksum is used to detect data corruption of an advertisement. This corruption can occur while an advertisement is being flooded, or while it is being held in a router's memory. This field is the checksum of the complete contents of the advertisement, except the LS age field.

**Options** - The Options field in the link state advertisement header indicates which optional capabilities are associated with the advertisement. The options are:

- **Q** - This enables support for QoS Traffic Engineering.
- **E** - This describes the way AS-external-LSAs are flooded.
- **MC** - This describes the way IP multicast datagrams are forwarded according to the standard specifications.
- **O** - This describes whether Opaque-LSAs are supported.
- **V** - This describes whether OSPF++ extensions for VPN/COS are supported.

### Command Buttons

**Refresh** - Refresh the data on the screen with the present state of the data in the switch.

OSPF Link State Database								Print	Reload	Help
Router ID	Area ID	LSA Type	LS ID	Age	Sequence	Checksum	Options			
1.1.1.1	0.0.0.0	Router Links	1.1.1.1	355	80000006	0x436	-E ---			
200.0.0.0	0.0.0.0	Router Links	200.0.0.0	568	80000016	0x3a5c	-E ---			
1.1.1.1	0.0.0.0	Network Links	192.168.101.54	565	80000001	0xfa89	-E ---			

### 11.2.3.3.10. Configuring OSPF Virtual Link

#### Selection Criteria

**Create New Virtual Link** - Select this option from the dropdown menu to define a new virtual link. The area portion of the virtual link identification is fixed: you will be prompted to enter the Neighbor Router ID on a new screen.

**Area ID and Neighbor Router ID** - Select the virtual link for which you want to display or configure data. It consists of the Area ID and Neighbor Router ID.

## Configurable Data

**Neighbor Router ID** - Enter the neighbor portion of a Virtual Link specification. Virtual links may be configured between any pair of area border routers having interfaces to a common (non-backbone) area. You only enter this ID when you are creating a new virtual link.

**Hello Interval** - Enter the OSPF hello interval for the specified interface in seconds. This parameter must be the same for all routers attached to a network. Valid values range from 1 to 65,535. The default is 10 seconds. .

**Dead Interval** - Enter the OSPF dead interval for the specified interface in seconds. This specifies how long a router will wait to see a neighbor router's Hello packets before declaring that the router is down. This parameter must be the same for all routers attached to a network. This value should be a multiple of the Hello Interval (e.g. 4). Valid values range from 1 to 2147483647. The default is 40.

**Iftransit Delay Interval** - Enter the OSPF Transit Delay for the specified interface. This specifies the estimated number of seconds it takes to transmit a link state update packet over the selected interface. Valid values range from 1 to 3600 seconds (1 hour). The default value is 1 second.

**Retransmit Interval** - Enter the OSPF retransmit interval for the specified interface. This is the number of seconds between link-state advertisements for adjacencies belonging to this router interface. This value is also used when retransmitting database descriptions and link-state request packets. Valid values range from 1 to 3600 seconds (1 hour). The default is 5 seconds.

**Authentication Type** - You may select an authentication type other than none by clicking on the 'Configure Authentication' button. You will then see a new screen, where you can select the authentication type from the pulldown menu. The choices are:

- **None** - This is the initial interface state. If you select this option from the pulldown menu on the second screen you will be returned to the first screen.
- **Simple** - If you select 'Simple' you will be prompted to enter an authentication key. This key will be included, in the clear, in the OSPF header of all packets sent on the network. All routers on the network must be configured with the same key.
- **Encrypt** - If you select 'Encrypt' you will be prompted to enter both an authentication key and an authentication ID. Encryption uses the MD5 Message-Digest algorithm. All routers on the network must be configured with the same key and ID.

**Authentication Key** - Enter the OSPF Authentication Key for the specified interface. If you do not choose to use authentication you will not be prompted to enter a key. If you choose 'simple' authentication you cannot use a key of more than 8 octets. If you choose 'encrypt' the key may be up to 16 octets long. The key value will only be displayed if you are logged on with Read/Write privileges, otherwise it will be displayed as asterisks.

**Authentication ID** - Enter the ID to be used for authentication. You will only be prompted to enter an ID when you select 'Encrypt' as the authentication type. The ID is a number between 0 and 255, inclusive.

## Non-Configurable Data

**Down** - This is the initial interface state. In this state, the lower-level protocols have indicated that the interface is unusable. In this state, interface parameters will be set to their initial values. All interface timers will be disabled, and there will be no adjacencies associated with the interface.

**Waiting** - The router is trying to determine the identity of the (Backup) Designated Router by monitoring received Hello Packets. The router is not allowed to elect a Backup Designated Router or a Designated Router until it transitions out of Waiting state. This prevents unnecessary changes of (Backup) Designated Router.

**Point-to-Point** - The interface is operational, and is connected to the virtual link. On entering this state the router attempts to form an adjacency with the neighboring router. Hello Packets are sent to the neighbor every HelloInterval seconds.

**Designated Router** - This router is itself the Designated Router on the attached network. Adjacencies are established to all other routers attached to the network. The router must also originate a network-LSA for the network node. The network- LSA will contain links to all routers (including the Designated Router itself) attached to the network.

**Backup Designated Router** - This router is itself the Backup Designated Router on the attached network. It will be promoted to Designated Router if the present Designated Router fails. The router establishes adjacencies to all other routers attached to the network. The Backup Designated Router performs slightly different functions during the Flooding Procedure, as compared to the Designated Router.

**Other Designated Router** - The interface is connected to a broadcast or NBMA network on which other routers have been selected to be the Designated Router and Backup Designated Router. The router attempts to form adjacencies to both the Designated Router and the Backup Designated Router.

**Neighbor State** - The state of the Virtual Neighbor Relationship.



## Command Buttons

**Configure Authentication** - Display a new screen where you can select the authentication method for the virtual link.

**Submit** - Send the updated configuration to the switch. Configuration changes take effect immediately. These changes will not be retained across a power cycle unless a save is performed.

**Delete** - Removes the specified virtual link from the router configuration.

OSPF Virtual Link Configuration

 Print
  Reload
  Help

---

Virtual Link (Area ID - Neighbor Router ID)	<input type="text" value="0.0.0.1 - 200.0.0.0"/>
Hello Interval (secs)	<input type="text" value="10"/> (1 to 65535)
Dead Interval (secs)	<input type="text" value="40"/> (1 to 2147483647)
Iftransit Delay Interval (secs)	<input type="text" value="1"/> (0 to 3600)
State	Down
Neighbor State	Down
Retransmit Interval (secs)	<input type="text" value="5"/> (0 to 3600)
Authentication Type	None

### 11.2.3.3.11. Viewing OSPF Virtual Link Summary Table

#### Non-Configurable Data

**Area ID** - The Area ID portion of the virtual link identification for which data is to be displayed. The Area ID and Neighbor Router ID together define a virtual link.

**Neighbor Router ID** - The neighbor portion of the virtual link identification. Virtual links may be configured between any pair of area border routers having interfaces to a common (non-backbone) area.

**Hello Interval** - The OSPF hello interval for the virtual link in units of seconds. The value for hello interval must be the same for all routers attached to a network.

**Dead Interval** - The OSPF dead interval for the virtual link in units of seconds. This specifies how long a router will wait to see a neighbor router's Hello packets before declaring that the router is down. This parameter must be the same for all routers attached to a common network, and should be a multiple of the Hello Interval (i.e. 4).

**Retransmit Interval** - The OSPF retransmit interval for the virtual link in units of seconds. This specifies the time between link-state advertisements for adjacencies belonging to this router interface. This value is also used when retransmitting database descriptions and link-state request packets.

**Iftransit Delay Interval** - The OSPF Transit Delay for the virtual link in units of seconds. It specifies the estimated number of seconds it takes to transmit a link state update packet over this interface.

#### Command Buttons

**Refresh** - Refresh the data on the screen with the present state of the data in the switch.

OSPF Virtual Link Summary					
Area ID	Neighbor Router ID	Hello Interval (secs)	Dead Interval (secs)	Retransmit Interval (secs)	Iftransit Delay Interval (secs)
0.0.0.1	200.0.0.0	10	40	5	1
Refresh					

### 11.2.3.3.12. Configuring OSPF Route Redistribution

This screen can be used to configure the OSPF Route Redistribution parameters. The allowable values for each fields are displayed next to the field. If any invalid values are entered, an alert message will be displayed with the list of all the valid values.

#### Configurable Data

**Configured Source** - This select box is a dynamic selector and would be populated by only those Source Routes that have already been configured for redistribute by OSPF. However, the topmost option in the select box would be "Create", and this allows the user to configure another, among the Available Source Routes. The valid values are 'Static', 'Connected', 'RIP', 'BGP' and 'Create'.

**Available Source** - This select box is a dynamic selector and would be populated by only those Source Routes that have not previously been configured for redistribution by OSPF. This select box would appear only if the user selects "Create" option as Configured Source. The valid values are 'Static', 'Connected', 'RIP' and 'BGP'.

**Metric**- Sets the metric value to be used as the metric of redistributed routes. This field displays the metric if the source was pre-configured and can be modified. The valid values are (0 to 16777215)

**Metric Type** - Sets the OSPF metric type of redistributed routes.

**Tag** - Sets the tag field in routes redistributed. This field displays the tag if the source was pre-configured, otherwise 0 and can be modified. The valid values are 0 to 4294967295.

**Subnets** - Sets whether the subnetted routes should be redistributed or not.

**Distribute List** - Sets the Access List that filters the routes to be redistributed by the destination protocol. Only permitted routes are redistributed. If this command refers to a non-existent access list, all routes are permitted. The valid values for Access List IDs are (1 to 199). When used for route filtering, the only fields in an access list that get used are

- **Source IP Address and netmask**
- **Destination IP Address and netmask**
- **Action (permit or deny)**

All other fields (source and destination port, precedence, tos, etc.) are ignored. The source IP address is compared to the destination IP address of the route. The source IP netmask in the access list rule is treated as a wildcard mask, indicating which bits in the source IP address must match the destination address of the route. (Note that a 1 in the mask indicates a "don't care" in the corresponding address bit.)

When an access list rule includes a destination IP address and netmask (an extended access list), the destination IP address is compared to the network mask of the destination of the route. The destination netmask in the access list serves as a wildcard mask, indicating which bits in the route's destination mask are significant for the filtering operation.

### Command Buttons

**Submit** - Send the updated configuration to the router. Configuration changes take effect immediately.

**Delete** - Delete the entry of the Source Route selected as Configured Source from the list of Sources configured for OSPF Route Redistribution.

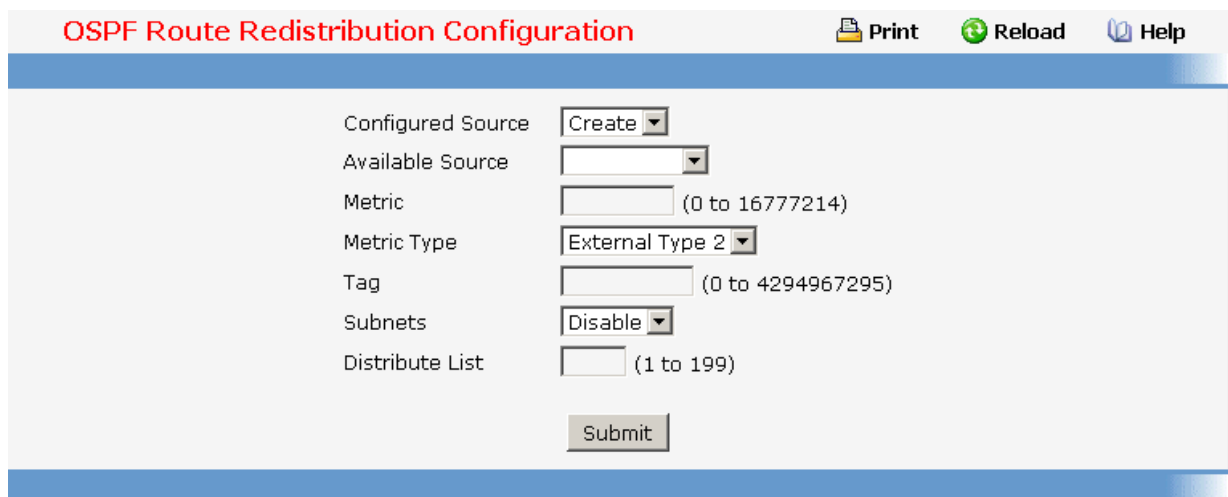

The screenshot shows the "OSPF Route Redistribution Configuration" web interface. At the top, there are three icons: "Print", "Reload", and "Help". Below the title bar, the configuration fields are as follows:

- Configured Source:
- Available Source:
- Metric:  (0 to 16777214)
- Metric Type:
- Tag:  (0 to 4294967295)
- Subnets:
- Distribute List:  (1 to 199)

At the bottom of the form is a "Submit" button.

### 11.2.3.3.13. Viewing OSPF Route Redistribution Summary Information

This screen displays the OSPF Route Redistribution Configurations.

#### Non Configurable Data

**Source** - The Source Route to be Redistributed by OSPF.

**Metric**- The Metric of redistributed routes for the given Source Route. Display "Unconfigured" when not configured.

**Metric Type** - The OSPF metric types of redistributed routes.



**Tag** - The tag field in routes redistributed. This field displays the tag if the source was pre-configured, otherwise 0 and can be modified. The valid values are 0 to 4294967295.

**Subnets** - Whether the subnetted routes should be redistributed or not.

**Distribute List** - The Access List that filters the routes to be redistributed by the Destination Protocol. Display 0 when not configured.

### Command Buttons

**Refresh** - Displays the latest OSPF Route Redistribution Configuration data.

OSPF Route Redistribution Summary					
Source	Metric	Metric Type	Tag	Subnets	Distribute List
Static	2	External Type 2	1	Disable	1

### 11.2.3.4 Managing BOOTP/DHCP Relay Agent

#### 11.2.3.4.1. Configuring BOOTP/DHCP Relay Agent

##### Configurable Data

**Maximum Hop Count** - Enter the maximum number of hops a client request can take before being discarded.

**Server IP Address** - Enter either the IP address of the BOOTP/DHCP server or the IP address of the next BOOTP/DHCP Relay Agent.

**Admin Mode** - Select enable or disable from the pulldown menu. When you select 'enable' BOOTP/DHCP requests will be forwarded to the IP address you entered in the 'Server IP address' field.



**Minimum Wait Time (secs)**- Enter a time in seconds. This value will be compared to the time stamp in the client's request packets, which should represent the time since the client was powered up. Packets will only be forwarded when the time stamp exceeds the minimum wait time.

**Circuit ID Option Mode** - Select enable or disable from the pulldown menu. If you select 'enable' Relay Agent options will be added to requests before they are forwarded to the server and removed from replies before they are forwarded to clients.

### Command Buttons

**Submit** - Send the updated configuration to the switch. Configuration changes take effect immediately. These changes will not be retained across a power cycle unless a save is performed.

BOOTP/DHCP Relay Agent Configuration

 **Print**   
  **Reload**   
  **Help**

Maximum Hop Count	<input type="text" value="4"/>	(1 to 16)
Server IP Address	<input type="text" value="0.0.0.0"/>	
Admin Mode	<input type="text" value="Disable"/>	
Minimum Wait Time (secs)	<input type="text" value="0"/>	(0 to 100)
Circuit ID Option Mode	<input type="text" value="Disable"/>	

#### 11.2.3.4.2. Viewing BOOTP/DHCP Relay Agent Status

##### Non-Configurable Data

**Maximum Hop Count** - The maximum number of Hops a client request can go without being discarded.

**Server IP Address** - IP address of the BOOTP/DHCP server or the IP address of the next BOOTP/DHCP Relay Agent.

**Admin Mode** - Administrative mode of the relay. When you select 'enable' BOOTP/DHCP requests will be forwarded to the IP address you entered in the 'Server IP address' field.



**Minimum Wait Time (secs)** - The Minimum time in seconds. This value will be compared to the time stamp in the client's request packets, which should represent the time since the client was powered up. Packets will only be forwarded when the time stamp exceeds the minimum wait time.

**Circuit ID Option Mode** - This is the Relay agent option which can be either enabled or disabled. When enabled Relay Agent options will be added to requests before they are forwarded to the server and removed from replies before they are forwarded to clients.

**Requests Received** - The total number of BOOTP/DHCP requests received from all clients since the last time the switch was reset.

**Requests Relayed** - The total number of BOOTP/DHCP requests forwarded to the server since the last time the switch was reset.

**Packets Discarded** - The total number of BOOTP/DHCP packets discarded by this Relay Agent since the last time the switch was reset.

<b>BOOTP/DHCP Relay Agent Status</b>		 <b>Print</b>	 <b>Reload</b>	 <b>Help</b>
Maximum Hop Count	4			
Server IP Address	0.0.0.0			
Admin Mode	Disable			
Minimum Wait Time (secs)	0			
Circuit ID Option Mode	Disable			
Requests Received	0			
Requests Relayed	0			
Packets Discarded	0			

### 11.2.3.5 Managing DNS Relay

#### 11.2.3.5.1. Configuring DNS Relay

The DNS protocol controls the Domain Name System (DNS), a distributed database with which you can map host names to IP addresses. When you configure DNS on your switch, you can substitute the host name for the IP address with all IP commands, such as ping, telnet, traceroute, and related Telnet support operations. To keep track of domain names, IP has defined the concept of a domain name server, which holds a cache (or database) of names mapped to IP addresses. To map domain names to IP addresses, you must first identify the host names, specify the name server that is present on your network, and enable the DNS.

#### Configurable Data



**Admin Mode** - Select enable or disable from the pull down menu. When you select 'enable', the IP Domain Naming System (DNS)-based host name-to-address translation will be enabled.

**Default Domain Name** - Default domain name used to complete unqualified host names. Do not include the initial period that separates an unqualified name from the domain name. This is a text string of up to 64 characters.

#### Command Buttons

**Submit** - Send the updated configuration to the switch. Configuration changes take effect immediately. These changes will not be retained across a power cycle unless a save is performed

DNS Relay Configuration

 Print
  Reload
  Help

Admin Mode

Default Domain Name

### 11.2.3.5.2. Configuring Domain Name

You can use this panel to change the configuration parameters for the domain names that can be appended to incomplete host names (i.e., host names passed from a client that are not formatted with dotted notation). You can also use this screen to display the contents of the table.

#### Configurable Data

**Domain** - Specifies all the existing domain names along with an additional option "Create". When the user selects "Create" another text box "Domain Name" appears where the user may enter domain name to be configured.

**Domain Name** - Specifies the domain name. Do not include the initial period that separates an unqualified name from the domain name. This is a text string of up to 64 characters.



#### Command Buttons

**Submit** - Sends the updated configuration to the switch. Configuration changes take effect immediately.

**Delete** - Deletes the domain name entry. Sends the updated configuration to the switch. Configuration changes take effect immediately.

**Delete All** - Deletes all the domain name entries. Sends the updated configuration to the switch. Configuration changes take effect immediately.

Domain Name Configuration

 Print
  Reload
  Help

Domain

Domain Name

### 11.2.3.5.3. Configuring Name Server

You can use this panel to change the configuration parameters for the domain name servers. You can also use this screen to display the contents of the table.

#### Configurable Data

**Name Server** - Specifies all the existing domain name servers along with an additional option "Create". When the user selects "Create" another text box "IP Address" appears where the user may enter domain name server to be configured.

**IP Address** - Specifies the address of the domain name server. This is a text string of up to 64 characters containing the encoded unicast IP address of a domain name server.

#### Non-Configurable Data

**Request** - Specifies the number of DNS requests since last time agent reboot.

**Response** - Specifies the number of DNS Server responses since last time agent reboot.

#### Command Buttons

**Submit** - Sends the updated configuration to the switch. Configuration changes take effect immediately.

**Delete** - Deletes the domain name server entry. Sends the updated configuration to the switch. Configuration changes take effect immediately.

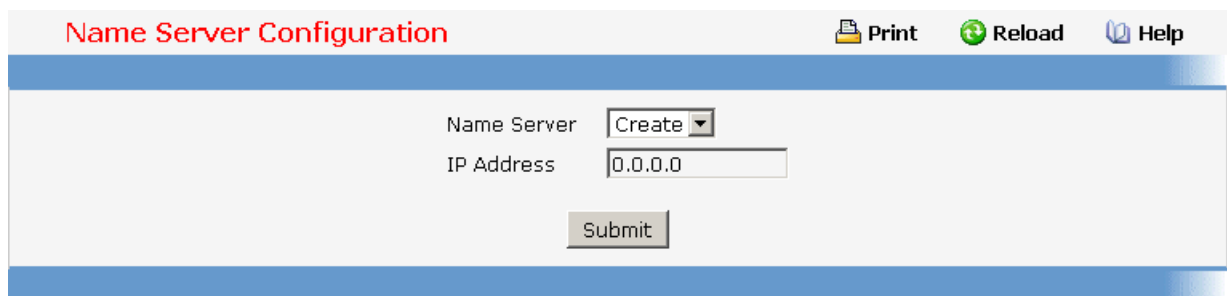

### 11.2.3.5.4. Viewing DNS Cache Summary Information

The Domain Name System (DNS) dynamically maps domain name to Internet (IP) addresses. This panel displays the current contents of the DNS cache.

#### Non-Configurable Data

**Domain Name List** - The domain name associated with this record.

**IP address** - The IP address associated with this record.

**TTL** - The time to live reported by the name server.

**Flag** - The flag of the record.

### Command Buttons

**Refresh** - Refresh the page with the latest DNS cache entries.

**Clear All** - Clear all entries in the DNS cache.

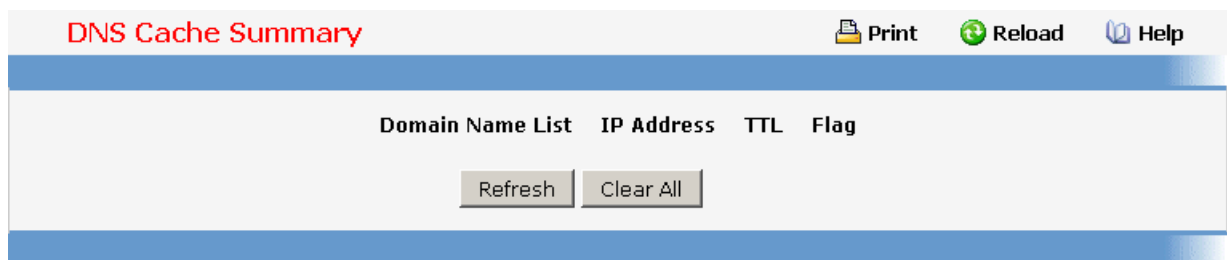

### 11.2.3.5.5. Configuring DNS Host

You can use this screen to change the configuration parameters for the static entry in the DNS table. You can also use this screen to display the contents of the table.

#### Configurable Data

**Domain** - Specifies all the existing hosts along with an additional option "Create". When the user selects "Create" another text box "Domain Name" appears where the user may enter host to be configured.

**Domain Name** - Specifies the domain name of the host. This is a text string of up to 64 characters.

**IP Address** - Specifies the address of the host. This is a text string of up to 64 characters containing the encoded unicast IP address of a host.



#### Command Buttons

**Submit** - Sends the updated configuration to the switch. Configuration changes take effect immediately.

**Delete** - Deletes the host entry. Sends the updated configuration to the switch. Configuration changes take effect immediately.

**Delete All** - Deletes all the host entries. Sends the updated configuration to the switch. Configuration changes take effect immediately.

Hosts Configuration

 Print
  Reload
  Help

Domain

Domain Name

IP Address

### 11.2.3.6 Managing Routing Information Protocol (RIP)

#### 11.2.3.6.1. Configuring RIP Global Configuration Page

##### Configurable Data

**RIP Admin Mode** - Select enable or disable from the pulldown menu. If you select enable RIP will be enabled for the switch. The default is disabled.

**Split Horizon Mode** - Select none, simple or poison reverse from the pulldown menu. Split horizon is a technique for avoiding problems caused by including routes in updates sent to the router from which the route was originally learned. The options are:

**None** - no special processing for this case.

**Simple** - a route will not be included in updates sent to the router from which it was learned.

**Poisoned reverse** - a route will be included in updates sent to the router from which it was learned, but the metric will be set to infinity.

The default is simple.

**Auto Summary Mode** - Select enable or disable from the pulldown menu. If you select enable groups of adjacent routes will be summarized into single entries, in order to reduce the total number of entries. The default is disabled.

**Host Routes Select Mode** - Select enable or disable from the pulldown menu. If you select enable the router will be accept host routes. The default is enabled.

**Default Information Originate** - Enable or Disable Default Route Advertise.

**Default Metric** - Sets a default for the metric of redistributed routes. This field displays the default metric if one has already been set or blank if not configured earlier. The valid values are (1 to 15)

##### Non-Configurable Data

**Global Route Changes** - The number of route changes made to the IP Route Database by RIP. This does not include the refresh of a route's age.



**Global queries** - The number of responses sent to RIP queries from other systems.

##### Command Buttons

**Submit** - Send the updated configuration to the switch. Configuration changes take effect

immediately. These changes will not be retained across a power cycle unless a save is performed.

RIP Configuration

 Print
  Reload
  Help

RIP Admin Mode	<input type="text" value="Enable"/>
Split Horizon Mode	<input type="text" value="Simple"/>
Auto Summary Mode	<input type="text" value="Disable"/>
Host Routes Accept Mode	<input type="text" value="Enable"/>
Global Route Changes	<input type="text" value="0"/>
Global Queries	<input type="text" value="0"/>
Default Information Originate	<input type="text" value="Disable"/>
Default Metric	<input type="text" value=""/> (1 to 15)

### 11.2.3.6.2. Viewing Each Routing Interface's RIP Configuration Page

#### Non-Configurable Data

**Slot/Port** - The slot and port for which the information is being displayed.

**IP Address** - The IP Address of the router interface.

**Send Version** - The RIP version to which RIP control packets sent from the interface conform. The value is one of the following:

**RIP-1** - RIP version 1 packets will be sent using broadcast.

**RIP-1c** - RIP version 1 compatibility mode. RIP version 2 formatted packets will be transmitted using broadcast.

**RIP-2** - RIP version 2 packets will be sent using multicast.

**None** - RIP control packets will not be transmitted.

The default is RIP-2.

**Receive Version** - Which RIP version control packets will be accepted by the interface. The value is one of the following:

**RIP-1** - only RIP version 1 formatted packets will be received.

**RIP-2** - only RIP version 2 formatted packets will be received.

**Both** - packets will be received in either format.

**None** - no RIP control packets will be received.

The default is Both.

**RIP Admin Mode** - Whether RIP is enabled or disabled on the interface.

**Link State** - Whether the RIP interface is up or down.

#### Command Buttons



**Refresh** - Refresh the data on the screen with the present state of the data in the switch.

RIP Interface Summary						
Slot/Port	IP Address	Send Version	Receive Version	RIP Admin Mode	Link State	
0/3	192.168.100.22	RIP-2	Both	Enable	Link Up	
<input type="button" value="Refresh"/>						

### 11.2.3.6.3. Defining The Routing Interface's RIP Configuration Page

#### Selection Criteria

**Slot/Port** - Select the interface for which data is to be configured.

#### Configurable Data

**Send Version** - Select the version of RIP control packets the interface should send from the pulldown menu. The value is one of the following:

**RIP-1** - send RIP version 1 formatted packets via broadcast.

**RIP-1c** - RIP version 1 compatibility mode. Send RIP version 2 formatted packets via broadcast.

**RIP-2** - send RIP version 2 packets using multicast.

**None** - no RIP control packets will be sent.

The default is RIP-2.

**Receive Version** - Select what RIP control packets the interface will accept from the pulldown menu. The value is one of the following:

**RIP-1** - accept only RIP version 1 formatted packets.

**RIP-2** - accept only RIP version 2 formatted packets.

**Both** - accept packets in either format.

**None** - no RIP control packets will be accepted.

The default is Both.

**RIP Admin Mode** - Select enable or disable from the pulldown menu. Before you enable RIP version 1 or version 1c on an interface, you must first enable network directed broadcast mode on the corresponding interface. The default value is disabled.

**Authentication Type** - You may select an authentication type other than none by clicking on the 'Configure Authentication' button. You will then see a new screen, where you can select the authentication type from the pulldown menu. The choices are:

**None** - This is the initial interface state. If you select this option from the pulldown menu on the second screen you will be returned to the first screen and no authentication protocols will be run.

**Simple** - If you select 'Simple' you will be prompted to enter an authentication key.

This key will be included, in the clear, in the OSPF header of all packets sent on the network. All routers on the network must be configured with the same key.

**Encrypt** - If you select 'Encrypt' you will be prompted to enter both an authentication key and an authentication ID. Encryption uses the MD5 Message-Digest algorithm. All routers on the network must be configured with the same key and ID.

**Authentication Key** - Enter the OSPF Authentication Key for the specified interface. If you do not choose to use authentication you will not be prompted to enter a key. If you choose 'simple' or 'encrypt' the key may be up to 16 octets long. The key value will only be displayed if you are logged on with Read/Write privileges, otherwise it will be displayed as asterisks.

### Non-Configurable Data

**IP Address** - The IP Address of the router interface.

**Link State** - Indicates whether the RIP interface is up or down.

**Bad Packets Received** - The number of RIP response packets received by the RIP process which were subsequently discarded for any reason.

**Bad Routes Received** - The number of routes, in valid RIP packets, which were ignored for any reason (e.g. unknown address family, or invalid metric).

**Updates Sent** - The number of triggered RIP updates actually sent on this interface. This explicitly does NOT include full updates sent containing new information.

### Command Buttons

**Configure Authentication** - Display a new screen where you can select the authentication method for the virtual link.

**Submit** - Send the updated configuration to the switch. Configuration changes take effect immediately. These changes will not be retained across a power cycle unless a save is performed

RIP Interface Configuration

Print
 Reload
 Help

---

Slot/Port	0/3	
Send Version	RIP-2	
Receive Version	Both	
RIP Admin Mode	Enable	
Authentication Type	None	<a href="#">Configure Authentication</a>
IP Address	192.168.100.22	
Link State	Link Up	
Bad Packets Received	0	
Bad Routes Received	0	
Updates Sent	2	

[Submit](#)

#### 11.2.3.6.4. Configuring Route Redistribution Configuration

This screen can be used to configure the RIP Route Redistribution parameters. The allowable values for each field are displayed next to the field. If any invalid values are entered, an alert message will be displayed with the list of all the valid values.

##### Configurable Data

**Configured Source** - This select box is a dynamic selector and would be populated by only those Source Routes that have already been configured for redistribute by RIP. However, the topmost option in the select box would be "Create", and this allows the user to configure another, among the Available Source Routes. The valid values are 'Static', 'Connected', 'OSPF' and 'Create'.

**Available Source** - This select box is a dynamic selector and would be populated by only those Source Routes that have not previously been configured for redistribution by RIP. This select box would appear only if the user selects "Create" option as Configured Source. The valid values are 'Static', 'Connected', and 'OSPF'.

**Metric**- Sets the metric value to be used as the metric of redistributed routes. This field displays the metric if the source was pre-configured and can be modified. The valid values are (1 to 15)

**Match** - One or more of these checkboxes must be selected to set the type of OSPF routes to be redistributed. This field would appear only if Source is "OSPF". This field displays the configured match options if "OSPF" was pre-configured and can be modified.

**Internal** - Sets Internal OSPF Routes to be redistributed

**External 1** - Sets External Type 1 OSPF Routes to be redistributed

**External 2** - Sets External Type 2 OSPF Routes to be redistributed

**NSSA-External 1** - Sets NSSA External Type 1 OSPF Routes to be redistributed

**NSSA-External 2** - Sets NSSA External Type 2 OSPF Routes to be redistributed

The default is Internal.

**Distribute List** - Distribute List - Sets the Access List that filters the routes to be redistributed by the destination protocol. Only permitted routes are redistributed. If this command refers to a non-existent access list, all routes are permitted. The valid values for Access List IDs are (1 to 199). When used for route filtering, the only fields in an access list that get used are

**Source IP Address and netmask**

**Destination IP Address and netmask**

**Action (permit or deny)**

All other fields (source and destination port, precedence, tos, etc.) are ignored.

The source IP address is compared to the destination IP address of the route. The source IP netmask in the access list rule is treated as a wildcard mask, indicating which bits in the source IP address must match the destination address of the route. (Note that a 1 in the mask indicates a "don't care" in the corresponding address bit.)

When an access list rule includes a destination IP address and netmask (an extended access list), the destination IP address is compared to the network mask of the destination of the route. The destination netmask in the access list serves as a wildcard mask, indicating which bits in the route's destination mask are significant for the filtering operation.

**Command Buttons**

**Submit** - Send the updated configuration to the router. Configuration changes take effect immediately.

**Delete** - Delete the entry of the Source Route selected as Configured Source from the list of Sources configured for RIP Route Redistribution.

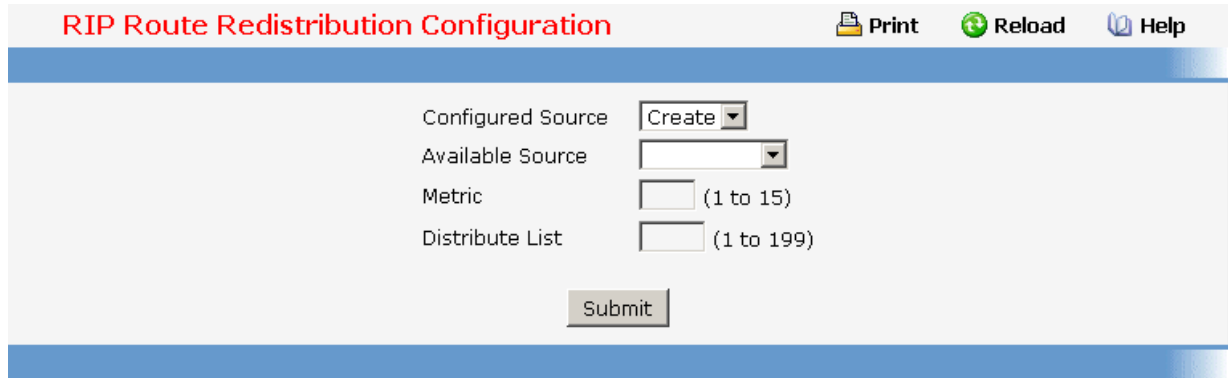
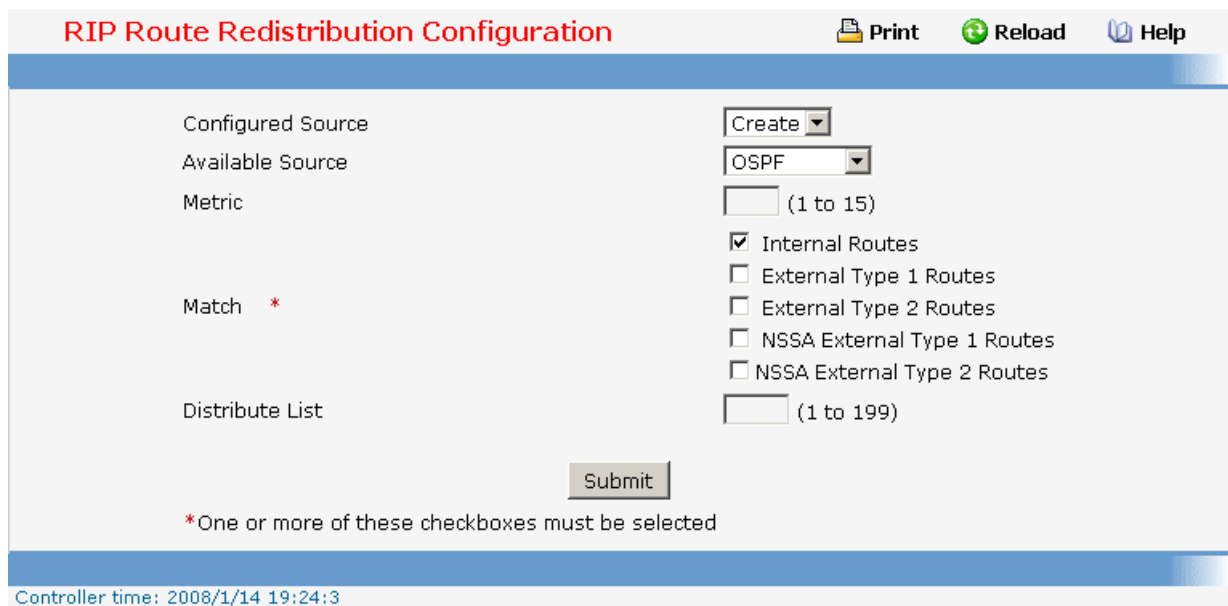

**11.2.3.6.5. Viewing Route Redistribution Configuration**

This screen displays the RIP Route Redistribution Configurations.

**Non Configurable Data**

**Source** - The Source Route to be Redistributed by RIP.

**Metric**- The Metric of redistributed routes for the given Source Route. Displays "Unconfigured" when not configured.

**Match** - List of Routes redistributed when "OSPF" is selected as Source. The list may include one or more of:

*Internal*

*External 1*

*External 2*

*NSSA-External 1*

*NSSA-External 2*

**Distribute List** - The Access List that filters the routes to be redistributed by the Destination Protocol. Displays 0 when not configured.

### Command Buttons

**Refresh** - Displays the latest RIP Route Redistribution Configuration data.

RIP Route Redistribution Summary			
Source	Metric	Match	Distribute List
Static	1	N.A.	1
<input type="button" value="Refresh"/>			

## 11.2.3.7 Managing Router Discovery

### 11.2.3.7.1. Configuring Router Discovery

#### Selection Criteria

**Slot/Port** - Select the router interface for which data is to be configured.

#### Configurable Data

**Advertise Mode** - Select enable or disable from the pulldown menu. If you select enable, Router Advertisements will be transmitted from the selected interface.

**Advertise Address** - Enter the IP Address to be used to advertise the router.

**Maximum Advertise Interval (secs)** - Enter the maximum time (in seconds) allowed between router advertisements sent from the interface.

**Minimum Advertise Interval (secs)** - Enter the minimum time (in seconds) allowed between router advertisements sent from the interface.



**Advertise Lifetime (secs)** - Enter the value (in seconds) to be used as the lifetime field in router advertisements sent from the interface. This is the maximum length of time that the advertised addresses are to be considered as valid router addresses by hosts.

**Preference Level** - Specify the preference level of the router as a default router relative to other routers on the same subnet. Higher numbered addresses are preferred. You must enter an integer.

### Command Buttons

**Submit** - Send the updated configuration to the switch. Configuration changes take effect immediately. The changes will not be retained across a power cycle unless a save is performed.

Router Discovery Configuration

 Print
  Reload
  Help

---

Slot/Port	<input type="text" value="0/1"/>	
Advertise Mode	<input type="text" value="Disable"/>	
Advertise Address	<input type="text" value="224.0.0.1"/>	
Maximum Advertise Interval (secs)	<input type="text" value="600"/>	(450 to 1800)
Minimum Advertise Interval (secs)	<input type="text" value="450"/>	(3 to 600)
Advertise Lifetime (secs)	<input type="text" value="1800"/>	(600 to 9000)
Preference Level	<input type="text" value="0"/>	(-2147483648 to 2147483647)

### 11.2.3.7.2. Viewing Router Discovery Status

#### Non-Configurable Data

**Slot/Port** - The router interface for which data is displayed.

**Advertise Mode** - The values are enable or disable. Enable denotes that Router Discovery is enabled on that interface.

**Advertise Address** - The IP Address used to advertise the router.

**Maximum Advertise Interval (secs)** - The maximum time (in seconds) allowed between router advertisements sent from the interface.

**Minimum Advertise Interval (secs)** - The minimum time (in seconds) allowed between router advertisements sent from the interface.

**Advertise Lifetime (secs)** - The value (in seconds) used as the lifetime field in router advertisements sent from the interface. This is the maximum length of time that the advertised addresses are to be considered as valid router addresses by hosts.

**Preference Level** - The preference level of the router as a default router relative to other routers on the same subnet. Higher numbered addresses are preferred.

Router Discovery Status						
Slot/Port	Advertise Mode	Advertise Address	Maximum Advertise Interval (secs)	Minimum Advertise Interval (secs)	Advertise Lifetime (secs)	Preference Level
0/1	Disable	224.0.0.1	600	450	1800	0
0/2	Disable	224.0.0.1	600	450	1800	0
0/3	Disable	224.0.0.1	600	450	1800	0
0/4	Disable	224.0.0.1	600	450	1800	0
0/5	Disable	224.0.0.1	600	450	1800	0
0/6	Disable	224.0.0.1	600	450	1800	0
0/7	Disable	224.0.0.1	600	450	1800	0
0/8	Disable	224.0.0.1	600	450	1800	0
0/9	Disable	224.0.0.1	600	450	1800	0
0/10	Disable	224.0.0.1	600	450	1800	0
0/11	Disable	224.0.0.1	600	450	1800	0
0/12	Disable	224.0.0.1	600	450	1800	0
0/13	Disable	224.0.0.1	600	450	1800	0
0/14	Disable	224.0.0.1	600	450	1800	0
0/15	Disable	224.0.0.1	600	450	1800	0
0/16	Disable	224.0.0.1	600	450	1800	0
0/17	Disable	224.0.0.1	600	450	1800	0
0/18	Disable	224.0.0.1	600	450	1800	0
0/19	Disable	224.0.0.1	600	450	1800	0

### 11.2.3.8 Managing Route Table

#### 11.2.3.8.1. Viewing Router Route Table

##### Non-Configurable Data

**Network Address** - The IP route prefix for the destination.

**Subnet Mask** - Also referred to as the subnet/network mask, this indicates the portion of the IP interface address that identifies the attached network.

**Protocol** - This field tells which protocol created the specified route. The possibilities are one of the following:

- **Local**
- **Static**
- **Default**
- **MPLS**
- **OSPF Intra**
- **OSPF Inter**
- **OSPF Type-1**

- **OSPF Type-2**
- **RIP**
- **BGP4**



**Next Hop Slot/Port** - The outgoing router interface to use when forwarding traffic to the destination.

**Next Hop IP Address** - The outgoing router IP address to use when forwarding traffic to the next router (if any) in the path towards the destination. The next router will always be one of the adjacent neighbors or the IP address of the local interface for a directly attached network.

**Total Number of Routes** - The total number of routes in the route table.

### Command Buttons

**Refresh** - Refresh the data on the screen with the present state of the data in the switch.

<b>Router Route Table</b>					
					 <b>Print</b>  <b>Reload</b>  <b>Help</b>
Total Number of Routes		1			
Network Address	Subnet Mask	Protocol	Next Hop Slot/Port	Next Hop IP Address	
192.168.100.0	255.255.255.0	Local	0/3	192.168.100.22	
<input type="button" value="Refresh"/>					

### 11.2.3.8.2. Viewing Router Best Route Table

#### Non-Configurable Data

**Network Address** - The IP route prefix for the destination.

**Subnet Mask** - Also referred to as the subnet/network mask, this indicates the portion of the IP interface address that identifies the attached network.

**Protocol** - This field tells which protocol created the specified route. The possibilities are one of the following:

- **Local**
- **Static**
- **Default**
- **MPLS**
- **OSPF Intra**
- **OSPF Inter**
- **OSPF Type-1**
- **OSPF Type-2**
- **RIP**



- **BGP4**



**Next Hop Slot/Port** - The outgoing router interface to use when forwarding traffic to the destination.

**Next Hop IP Address** - The outgoing router IP address to use when forwarding traffic to the next router (if any) in the path towards the destination. The next router will always be one of the adjacent neighbors or the IP address of the local interface for a directly attached network.

**Total Number of Routes** - The total number of routes in the route table.

### Command Buttons

**Refresh** - Refresh the data on the screen with the present state of the data in the switch.

Router Best Routes Table				
 <b>Print</b>  <b>Reload</b>  <b>Help</b>				
Total Number of Routes		1		
Network Address	Subnet Mask	Protocol	Next Hop Slot/Port	Next Hop IP Address
192.168.100.0	255.255.255.0	Local	0/3	192.168.100.22
<input type="button" value="Refresh"/>				

### 11.2.3.8.3. Configuring Router Static Route Entry

#### Selection Criteria

**Network Address** - Specifies the IP route prefix for the destination. In order to create a route a valid routing interface must exist and the next hop IP Address must be on the same network as the routing interface. Routing interfaces are created on the IP Interface Configuration page. Valid next hop IP Addresses can be viewed on the 'Route Table' screen.

**Route Type** - This field can be either default or static. If creating a default route, all that needs to be specified is the next hop IP address, otherwise each field needs to be specified.

#### Non-Configurable Data

**Subnet Mask** - Also referred to as the subnet/network mask, this indicates the portion of the IP interface address that identifies the attached network.

**Protocol** - This field tells which protocol created the specified route. The possibilities are one of the following:

- **Static**

- **Default**
- **MPLS**
- **OSPF Intra**
- **OSPF Inter**
- **OSPF Type-1**
- **OSPF Type-2**
- **RIP**
- **BGP4Local**

**Next Hop Slot/Port** - The outgoing router interface to use when forwarding traffic to the destination.

**Next Hop IP Address** - The outgoing router IP address to use when forwarding traffic to the next router (if any) in the path towards the destination. The next router will always be one of the adjacent neighbors or the IP address of the local interface for a directly attached network. When creating a route, the next hop IP must be on the same network as the routing interface. Valid next hop IP Addresses can be seen on the 'Route Table' page.

**Metric** - Administrative cost of the path to the destination. If no value is entered, default is 1. The range is 0 - 255.



**Preference** – Specifies a preference value for the configured next hop.

### Command Buttons

**Get** - Get the route.

**Add Route** - Go to a separate page where a route can be created.

Router Route Entry Configuration

 **Print**
 **Reload**
 **Help**

Network Address

Subnet Mask	Protocol	Next Hop	Slot/Port	Next Hop IP Address	Metric	Preference
255.255.255.0	Local	0/3		192.168.100.22	0	0

#### 11.2.3.8.4. Configuring Router Static Route Entry

##### Selection Criteria

**Route Type** - This field can be either default or static. If creating a default route, all that needs to be specified is the next hop IP address, otherwise each field needs to be specified.

##### Non-Configurable Data

**Network Address** - The IP route prefix for the destination.

**Subnet Mask** - Also referred to as the subnet/network mask, this indicates the portion of the IP interface address that identifies the attached network.

**Next Hop IP Address** - The outgoing router IP address to use when forwarding traffic to the next router (if any) in the path towards the destination. The next router will always be one of the adjacent neighbors or the IP address of the local interface for a directly attached network.

**Preference** - Specifies a preference value for the configured next hop.

### Command Buttons

**Add Route** - Go to a separate page where a route can be created.

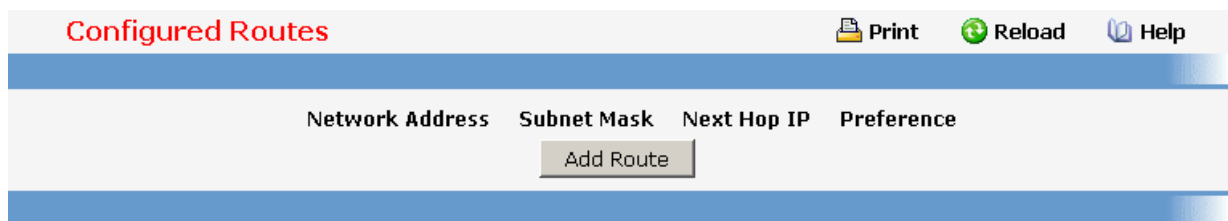

#### 11.2.3.8.5. Configuring Router Route Preference

Use this panel to configure the default preference for each protocol (e.g. 60 for static routes, 170 for BGP). These values are arbitrary values in the range of 1 to 255 and are independent of route metrics. Most routing protocols use a route metric to determine the shortest path known to the protocol, independent of any other protocol.

The best route to a destination is chosen by selecting the route with the lowest preference value. When there are multiple routes to a destination, the preference values are used to determine the preferred route. If there is still a tie, the route with the best route metric will be chosen. To avoid problems with mismatched metrics (i.e. RIP and OSPF metrics are not directly comparable) you must configure different preference values for each of the protocols.

### Configurable Data

**Static** - The static route preference value in the router. The default value is 1. The range is 1 to 255.

**OSPF Intra** - The OSPF intra route preference value in the router. The default value is 8. The range is 1 to 255. The OSPF specification (RFC 2328) requires that preferences must be given to the routes learned via OSPF in the following order: intra < inter < type-1 < type-2.

**OSPF Inter** - The OSPF inter route preference value in the router. The default value is 10.

The range is 1 to 255. The OSPF specification (RFC 2328) requires that preferences must be given to the routes learned via OSPF in the following order: intra < inter < type-1 < type-2.

**OSPF Type-1** - The OSPF type-1 route preference value in the router. The default value is 13. The range is 1 to 255. The OSPF specification (RFC 2328) requires that preferences must be given to the routes learned via OSPF in the following order: intra < inter < type-1 < type-2.

**OSPF Type-2** - The OSPF type-2 route preference value in the router. The default value is 150. The range is 1 to 255. The OSPF specification (RFC 2328) requires that preferences must be given to the routes learned via OSPF in the following order: intra < inter < type-1 < type-2.

**RIP** - The RIP route preference value in the router. The default value is 15. The range is 1 to 255.



### Non-Configurable Data

**Local** - This field displays the local route preference value.

### Command Buttons

**Submit** - Send the updated configuration to the switch. Configuration changes take effect immediately. These changes will not be retained across a power cycle unless a save is performed.

Router Route Preferences Configuration

 **Print**
 **Reload**
 **Help**

Local	0	
Static	<input style="width: 40px;" type="text" value="1"/>	(1 to 255)
OSPF Intra	<input style="width: 40px;" type="text" value="8"/>	(1 to 255)
OSPF Inter	<input style="width: 40px;" type="text" value="10"/>	(1 to 255)
OSPF Type-1	<input style="width: 40px;" type="text" value="13"/>	(1 to 255)
OSPF Type-2	<input style="width: 40px;" type="text" value="150"/>	(1 to 255)
RIP	<input style="width: 40px;" type="text" value="15"/>	(1 to 255)

## 11.2.3.9 Managing VLAN Routing

### 11.2.3.9.1. Configuring VLAN Routing

#### Selection Criteria

**VLAN ID** - Enter the ID of a VLAN you want to configure for VLAN Routing. Initially, the field will display the ID of the first VLAN. After you enter a new VLAN ID and click on the Create button the non-configurable data will be displayed. See below for detailed instructions on how to use that data to complete the configuration of the VLAN.

### Non-Configurable Data

**Slot/Port** - The interface assigned to the VLAN for routing.

**MAC Address** - The MAC Address assigned to the VLAN Routing Interface

### Command Buttons

**Create** - Send the updated configuration to the switch. Configuration changes take effect immediately. These changes will not be retained across a power cycle unless a save is performed.

**Delete** - Remove the VLAN Routing Interface specified in the *VLAN ID input field* from the router configuration.

### Instructions for creating a VLAN

- Enter a new VLAN ID in the field labeled VLAN ID.
- Click on the Create button. The page will be updated to display the interface and MAC address assigned to this new VLAN. The IP address and Subnet Mask fields will be 0.0.0.0.
- Note the interface assigned to the VLAN.
- Use the index pane to change to the IP Interface Configuration page.
- Select the interface assigned to the VLAN. The IP address and Subnet Mask fields will be 0.0.0.0.
- Enter the IP address and subnet mask for the VLAN.
- Select the Submit button.
- Change back to the VLAN Routing Summary page. The new VLAN should appear in the table with the correct IP address and subnet mask assigned.

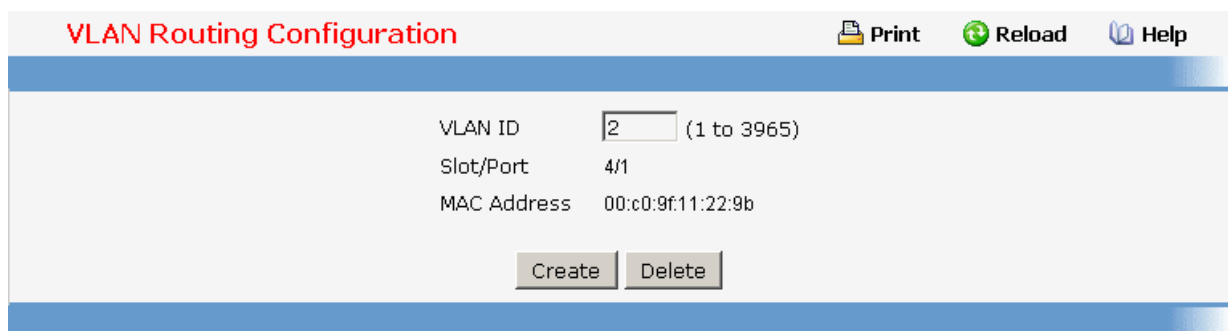

### 11.2.3.9.2. Viewing VLAN Routing Summary Information

#### Non-Configurable Data

**VLAN ID** - The ID of the VLAN whose data is displayed in the current table row

**Slot/Port** - The Slot/Port assigned to the VLAN Routing Interface

**MAC Address** - The MAC Address assigned to the VLAN Routing Interface

**IP Address** - The configured IP Address of the VLAN Routing Interface. This will be 0.0.0.0 when the VLAN Routing Interface is first configured and must be entered on the IP Interface Configuration page.

**Subnet Mask** - The configured Subnet Mask of the VLAN Routing Interface. This will be 0.0.0.0 when the VLAN Routing Interface is first configured and must be entered on the IP Interface Configuration page.

VLAN Routing Summary					Print	Reload	Help
VLAN ID	Slot/Port	MAC Address	IP Address	Subnet Mask			
2	4/1	00:C0:9F:11:22:9B	0.0.0.0	0.0.0.0			

### 11.2.3.10 Managing VRRP

#### 11.2.3.10.1. Configuring VRRP

##### Configurable Data

**VRRP Admin Mode** - This sets the administrative status of VRRP in the router to active or inactive. Select enable or disable from the pulldown menu. The default is disable.

##### Command Buttons

**Submit** - Send the updated configuration to the switch. Configuration changes take effect immediately. These changes will not be retained across a power cycle unless a save is performed.

VRRP Configuration		Print	Reload	Help
Admin Mode	Disable			
<input type="button" value="Submit"/>				

### 11.2.3.10.2. Configuring Virtual Router

#### Selection Criteria

**VRID and Slot/Port** - Select 'Create' from the pulldown menu to configure a new Virtual Router, or select one of the existing Virtual Routers, listed by interface number and VRID.

#### Configurable Data

**VRID** - This field is only configurable if you are creating new Virtual Router, in which case enter the VRID in the range 1 to 255 .

**Slot/Port** - This field is only configurable if you are creating new Virtual Router, in which case select the Slot/Port for the new Virtual Router from the pulldown menu.

**Pre-empt Mode** - Select enable or disable from the pulldown menu. If you select enable a backup router will preempt the master router if it has a priority greater than the master virtual router's priority provided the master is not the owner of the virtual router IP address. The default is enable.

**Priority** - Enter the priority value to be used by the VRRP router in the election for the master virtual router. If the Virtual IP Address is the same as the interface IP Address, the priority gets set to 255 no matter what the user enters. If the user enters a priority of 255 when the Virtual and interface IP Addresses are not the same, the priority gets set to the default value of 100.

**Advertisement Interval (secs)** - Enter the time, in seconds, between the transmission of advertisement packets by this virtual router. Enter a number between 1 and 255. The default value is 1 second.

**IP Address** - Enter the IP Address associated with the Virtual Router. The default is 0.0.0.0.

**Authentication Type** - Select the type of Authentication for the Virtual Router from the pulldown menu. The default is None. The choices are:

- **0-None** - No authentication will be performed.
- **1-Key** - Authentication will be performed using a text password.

**Authentication Data** - If you selected simple authentication, enter the password.

**Status** - Select active or inactive from the pulldown menu to start or stop the operation of the Virtual Router. The default is inactive.

#### Non-Configurable Data

**Interface IP Address** - Indicates the IP Address associated with the selected interface.

#### Command Buttons

**Submit** - Send the updated configuration to the switch. Configuration changes take effect

immediately. These changes will not be retained across a power cycle unless a save is performed.

**Delete** - Delete the selected Virtual Router. Note that the router can not be deleted if there are secondary addresses configured.

**Secondary IP Address** - Proceed to the Secondary IP Address configuration screen.

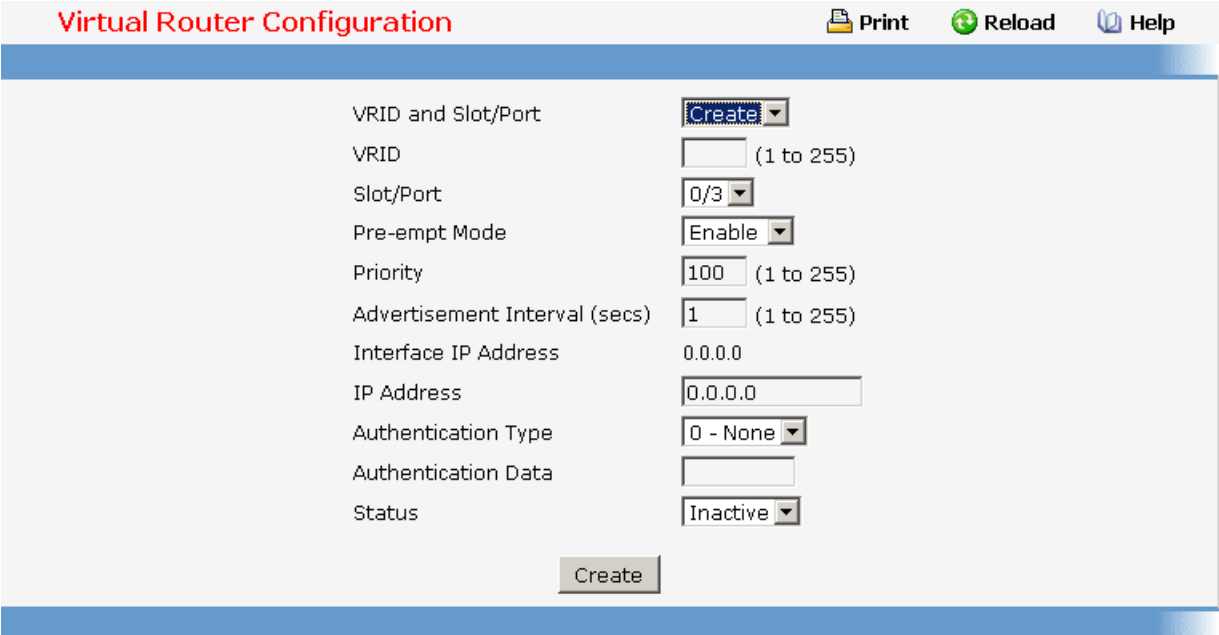

### 11.2.3.10.3. Viewing Virtual Router Status

#### Non-Configurable Data

**VRID** - Virtual Router Identifier.

**Slot/Port** - Indicates the interface associate with the VRID.

**Priority** - The priority value used by the VRRP router in the election for the master virtual router.

#### **Pre-empt Mode** -

- **Enable** - if the Virtual Router is a backup router it will preempt the master router if it has a priority greater than the master virtual router's priority provided the master is not the owner of the virtual router IP address.
- **Disable** - if the Virtual Router is a backup router it will not preempt the master router even if its priority is greater.

**Advertisement Interval (secs)** - the time, in seconds, between the transmission of advertisement packets by this virtual router.



**Virtual IP Address** - The IP Address associated with the Virtual Router.

**Interface IP Address** - The actual IP Address associated with the interface used by the Virtual Router.

**Owner** - Set to 'True' if the Virtual IP Address and the Interface IP Address are the same, otherwise set to 'False'. If this parameter is set to 'True', the Virtual Router is the owner of the Virtual IP Address, and will always win an election for master router when it is active.

**VMAC Address** - The virtual MAC Address associated with the Virtual Router, composed of a 24 bit organizationally unique identifier, the 16 bit constant identifying the VRRP address block and the 8 bit VRID.

**Auth Type** - The type of authentication in use for the Virtual Router

- **None**
- **Simple**

**State** - The current state of the Virtual Router:

- **Initialize**
- **Master**
- **Backup**

**Status** - The current status of the Virtual Router:

- **Inactive**
- **Active**

**Secondary IP Address** - The secondary IP address.

### Command Buttons

**Refresh** - Refresh the data on the screen with the present state of the data in the switch.

Virtual Router Status								
VRID	Slot/Port	Priority	Pre-empt Mode	Advertisement Interval (secs)	Virtual IP Address	Interface IP Address	Owner	VMAC Addr
22	0/3	100	Enable	1	0.0.0.0	192.168.100.22	False	00:00:5E:00

Refresh

### 11.2.3.10.4. Viewing Virtual Router Statistics

#### Selection Criteria

**VRID and Slot/Port** - Select the existing Virtual Router, listed by interface number and VRID, for which you want to display statistical information.

### Non-Configurable Data

**Router Checksum Errors** - The total number of VRRP packets received with an invalid VRRP checksum value.

**Router Version Errors** - The total number of VRRP packets received with an unknown or unsupported version number.

**Router VRID Errors** - The total number of VRRP packets received with an invalid VRID for this virtual router.

**VRID** - the VRID for the selected Virtual Router.

**Slot/Port** - The Slot/Port for the selected Virtual Router.

**Up Time** - The time, in days, hours, minutes and seconds, that has elapsed since the virtual router transitioned to the initialized state.

**State Transitioned to Master** - The total number of times that this virtual router's state has transitioned to Master.

**Advertisement Received** - The total number of VRRP advertisements received by this virtual router.

**Advertisement Interval Errors** - The total number of VRRP advertisement packets received for which the advertisement interval was different than the one configured for the local virtual router .

**Authentication Failure** - The total number of VRRP packets received that did not pass the authentication check.

**IP TTL Errors** - The total number of VRRP packets received by the virtual router with IP TTL (Time-To-Live) not equal to 255.

**Zero Priority Packets Received** - The total number of VRRP packets received by the virtual router with a priority of '0'.

**Zero Priority Packets Sent** - The total number of VRRP packets sent by the virtual router with a priority of '0'.

**Invalid Type Packets Received** - The number of VRRP packets received by the virtual router with an invalid value in the 'type' field.

**Address List Errors** - The total number of packets received for which the address list does not match the locally configured list for the virtual router.

**Invalid Authentication Type** - The total number of packets received with an unknown

authentication type.



**Authentication Type Mismatch** - The total number of packets received with an authentication type different to the locally configured authentication method.

**Packet Length Errors** - The total number of packets received with a packet length less than the length of the VRRP header.

### Command Buttons

**Refresh** - Refresh the data on the screen with the present state of the data in the switch.

Virtual Router Statistics

 **Print**   
  **Reload**   
  **Help**

Router Checksum Errors	0
Router Version Errors	0
Router VRID Errors	0
VRID and Slot/Port	22 - 0/3 ▾
VRID	22
Port	0/3
Up Time	0 days 0 hrs 0 mins 0 secs
State Transitioned to Master	0
Advertisement Received	0
Advertisement Interval Errors	0
Authentication Failure	0
IP TTL Errors	0
Zero Priority Packets Received	0
Zero Priority Packets Sent	0
Invalid Type Packets Received	0
Address List Errors	0
Invalid Authentication Type	0
Authentication Type Mismatch	0
Packet Length Errors	0

### 11.2.3.11 Managing Tunnels

#### 11.2.3.11.1. Configuring Tunnels Configuration Page

Tunnels can be created, configured and deleted from this page.

#### Configurable Data

**Tunnel** - Select list of currently configured tunnel interfaces. Create is also a valid choice if the maximum number of tunnel interfaces has not been created.

**Tunnel ID** - When 'Create' is chosen from the tunnel selector this list of available tunnel ID's becomes visible.

**Mode** - Selector for the Tunnel mode. IPV6-in-IPV4 is the only supported mode.

**IPv6 Mode** - Enable IPv6 on this interface using the IPv6 address. This option is only configurable prior to specifying an explicit IPv6 address.

**IPv6 Address** - Select list of configured IPv6 addresses for the selected Loopback interface. Add is also a valid choice if the maximum number of addresses has not been configured.

**IPv6 Address** - When 'Add' is chosen from the IPv6 Address selector this IPv6 address input field becomes visible. Address must be entered in the format prefix/length. The user also has the option to specify the 64-bit extended unique identifier (EUI-64).

**Source** - Select the desired source, Address or Interface. If Address is selected the the source address for this tunnel must be entered in dotted decimal notation. If Interface is selected the source interface for this tunnel must be selected. The address associated with the selected interface will be used as the source address.

**Destination Address** - The destination address for this tunnel in dotted decimal notation.

### Command Buttons

**Submit** - Update the system with the values on this screen.

**Delete Tunnel** - Remove the selected interface.

**Delete Selected Address** - Remove the selected IPv6 Address.

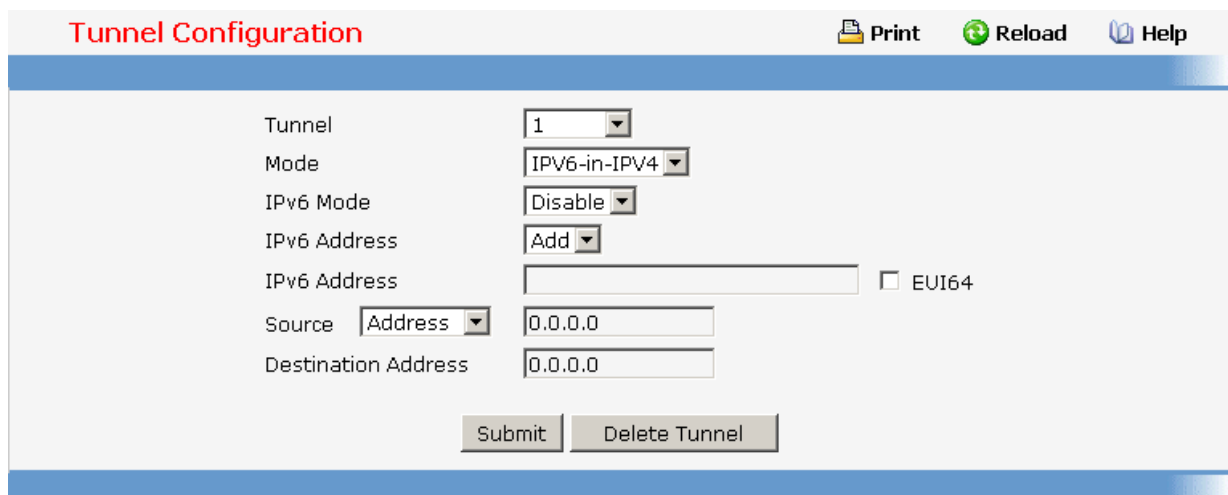

**Tunnel Configuration** Print Reload Help

Tunnel: 1

Mode: IPV6-in-IPV4

IPv6 Mode: Disable

IPv6 Address: Add

IPv6 Address:   EUI64

Source: Address

Destination Address:

### 11.2.3.11.2. Viewing Tunnels Summary Page

This page displays a summary of the configured tunnels.

#### Non-Configurable Data

**Tunnel ID** - The Tunnel ID.

**Mode** - The corresponding mode of the Tunnel.

**Address** - The IPv6 Address(es) of the Tunnel.

**Source** - The corresponding Tunnel Source Address. In the case where an interface has been configured both the interface and the address are displayed. If the source interface has no address configured the text 'unconfigured' is displayed in place of the address.

**Destination** - The corresponding Tunnel Destination Address.

#### Command Buttons

**Refresh** - Refresh the page with the latest Tunnel entries.

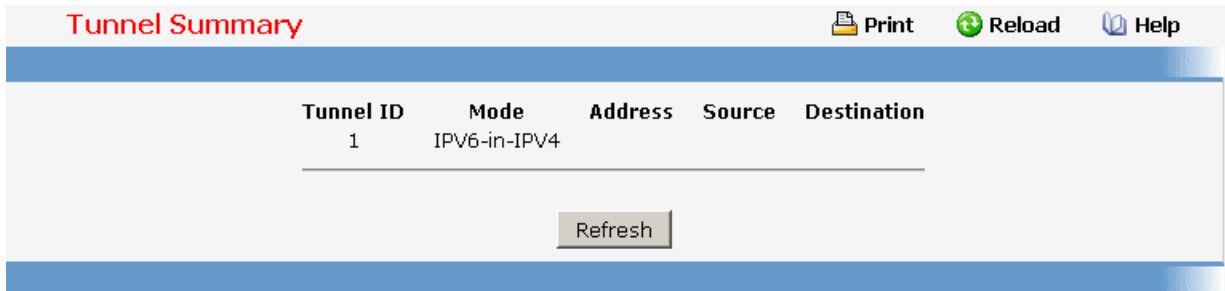

The screenshot shows a web interface titled "Tunnel Summary". At the top right, there are three icons: a printer icon labeled "Print", a circular refresh icon labeled "Reload", and a help icon labeled "Help". Below the title bar is a table with the following columns: Tunnel ID, Mode, Address, Source, and Destination. The table contains one row with the value "1" under Tunnel ID and "IPv6-in-IPv4" under Mode. Below the table is a "Refresh" button.

Tunnel ID	Mode	Address	Source	Destination
1	IPv6-in-IPv4			

### 11.2.3.12 Managing Loopbacks

#### 11.2.3.12.1. Configuring Loopbacks Configuration Page

Loopback interfaces can be created, configured and removed on this page.

#### Configurable Data

**Loopback** - Select list of currently configured loopback interfaces. Create is also a valid choice if the maximum number of loopback interfaces has not been created.

**Loopback ID** - When 'Create' is chosen from the Loopback selector this list of available loopback ID's becomes visible.

**Protocol** - Select IPv4 or IPv6 to configure the corresponding attributes on the loopback interface.

**IPv6 Mode** - Enable IPv6 on this interface using the IPv6 address. This option is only configurable prior to specifying an explicit IPv6 address.

**IPv6 Address** - Select list of configured IPv6 addresses for the selected Loopback interface. Add is also a valid choice if the maximum number of addresses has not been configured.

**IPv6 Address** - When 'Add' is chosen from the IPv6 Address selector this IPv6 address input field becomes visible. Address must be entered in the format prefix/length. The user also has the option to specify the 64-bit extended unique identifier (EUI-64).

**IPv4 Address** - The primary IPv4 address for this interface in dotted decimal notation.

**IPv4 Subnet Mask** - The primary IPv4 subnet mask for this interface in dotted decimal notation.

**Secondary Address** - Select list of configured IPv4 secondary addresses for the selected Loopback interface. Add Secondary is also a valid choice if the maximum number of secondary addresses has not been configured. A primary address must be configured before secondary addresses can be added.

**Secondary IP Address** - The secondary ip address for this interface in dotted decimal notation. This input field is visible only when 'Add Secondary' is selected.

**Secondary Subnet Mask** - The secondary subnet mask for this interface in dotted decimal notation. This input field is visible only when 'Add Secondary' is selected.

### Command Buttons

**Submit** - Update the system with the values on this screen.

**Delete Loopback** - Remove the selected loopback interface.

**Delete Primary** - Remove the configured Primary IPv4 Address.

**Add Secondary** - Add the user specified Secondary IPv4 Address.

**Delete Selected Secondary** - Remove the selected Secondary IPv4 Address.

**Delete Selected Address** - Remove the selected IPv6 Address.

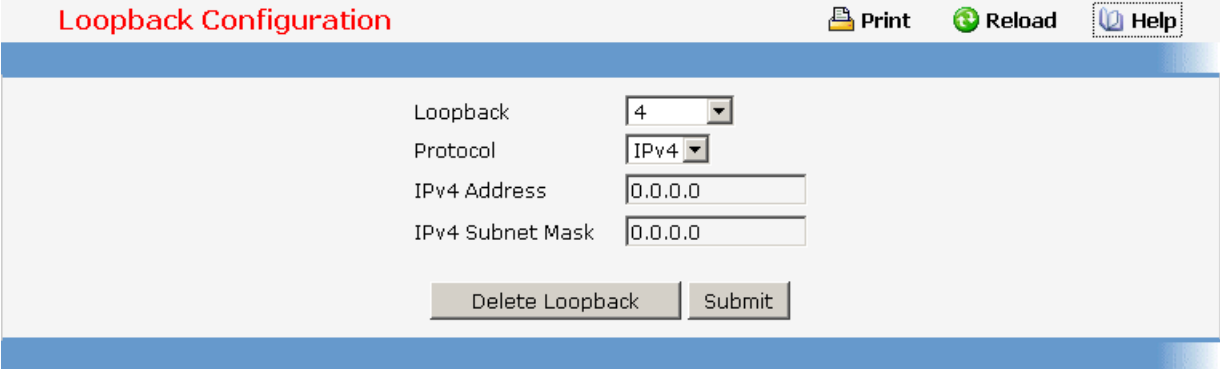

### 11.2.3.12.2. Viewing Loopbacks Summary Page

This page displays a summary of the configured Loopback interfaces.

#### Non-Configurable Data

**Loopback Interface** - The ID of the configured loopback interface.

**Addresses** - A list of the addresses configured on the loopback interface.

#### Command Buttons

**Refresh** - Refresh the page.

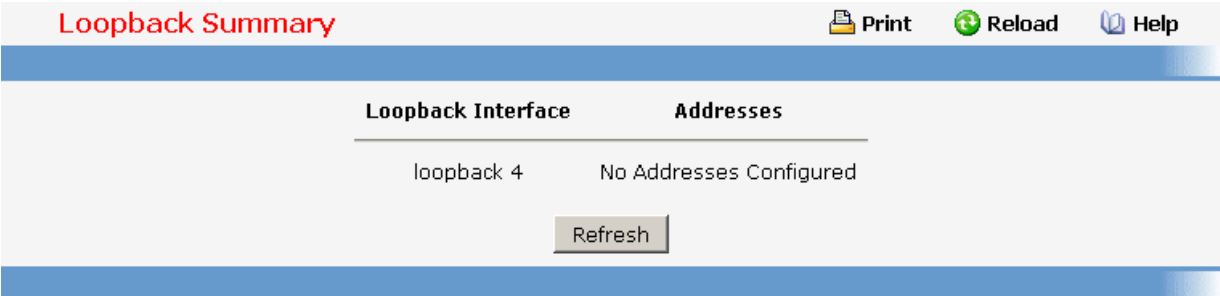

Loopback Interface	Addresses
loopback 4	No Addresses Configured

## 11.2.4 Security Menu

### 11.2.4.1 Managing Access Control (802.1x)

#### 11.2.4.1.1. Defining Access Control Page

##### Configurable Data

**Administrative Mode** - This selector lists the two options for administrative mode: enable and disable. The default value is disabled.

**Guest Vlan Supplicant Mode** - This selector lists the two options for Guest VLAN Supplicant mode: enable and disable. The default value is disable.

### Command Buttons

**Submit** - Sends the updated screen to the switch and causes the changes to take effect on the switch but these changes will not be retained across a power cycle unless a save is performed.

**Cancel** - This resets the page to display the administrative mode that is currently configured by the selected unit.

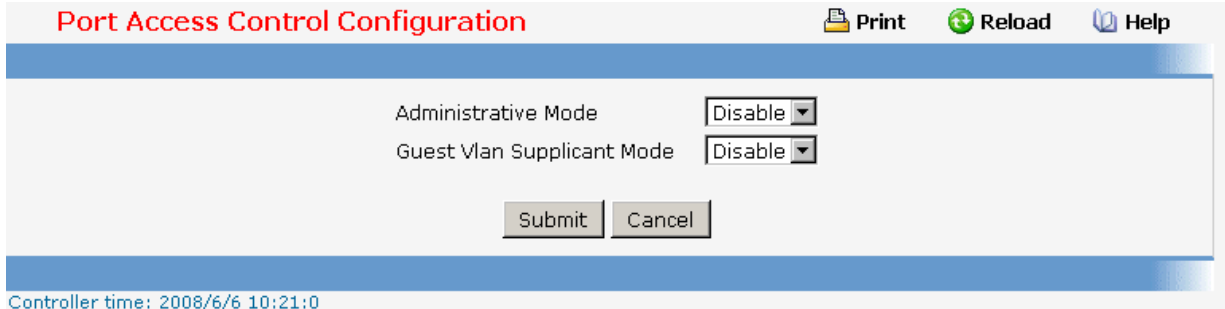

### 11.2.4.1.2. Configuring each Port Access Control Configuration Page

#### Selection Criteria

**Port** - Selects the port to be configured. When the selection is changed, a screen refresh will occur causing all fields to be updated for the newly selected port. All physical interfaces are valid.

#### Configurable Data

**Control Mode** - This selector lists the options for control mode. The control mode is only set if the link status of the port is link up. The options are:

*force unauthorized*: The authenticator port access entity (PAE) unconditionally sets the controlled port to unauthorized

*force authorized*: The authenticator PAE unconditionally sets the controlled port to authorized.

*auto*: The authenticator PAE sets the controlled port mode to reflect the outcome of the authentication exchanges between the supplicant, authenticator, and the authentication server.

**Quiet Period (secs)**- This input field allows the user to configure the quiet period for the selected port. This command sets the value, in seconds, of the timer used by the authenticator state machine on this port to define periods of time in which it will not attempt to acquire a supplicant. The quiet period is the period for which the authenticator does not attempt to acquire a supplicant after a failed authentication exchange with the supplicant. The quiet period must be a number in the range of 0 and 65535. A quiet period value of 0 means that the authenticator state machine will never acquire a supplicant. The default value is 60. Changing the value will not change the configuration until the Submit button is pressed.

**Transmit Period (secs)**- This input field allows the user to configure the transmit period



for the selected port. The transmit period is the value, in seconds, of the timer used by the authenticator state machine on the specified port to determine when to send an EAPOL EAP Request/Identity frame to the supplicant. The transmit period must be a number in the range of 1 to 65535. The default value is 30. Changing the value will not change the configuration until the Submit button is pressed.

**Guest VLAN Id (secs)** - This field allows the user to configure Guest Vlan Id on the interface. The valid range is 0 - L7\_PLATFORM\_MAX\_VLAN\_ID. The default value is 0. Changing the value will not change the configuration until the Submit button is pressed. *Enter 0 to reset the Guest Vlan Id on the interface.*

**Guest VLAN Period (secs)** - This input field allows the user to enter the guest Vlan period for the selected port. The guest Vlan period is the value, in seconds, of the timer used by the GuestVlan Authentication. The guest Vlan timeout must be a value in the range of 1 and 300. The default value is 90. Changing the value will not change the configuration until the Submit button is pressed.

**Supplicant Timeout (secs)**- This input field allows the user to enter the supplicant timeout for the selected port. The supplicant timeout is the value, in seconds, of the timer used by the authenticator state machine on this port to timeout the supplicant. The supplicant timeout must be a value in the range of 1 to 65535. The default value is 30. Changing the value will not change the configuration until the Submit button is pressed.

**Server Timeout (secs)**- This input field allows the user to enter the server timeout for the selected port. The server timeout is the value, in seconds, of the timer used by the authenticator on this port to timeout the authentication server. The server timeout must be a value in the range of 1 to 65535. The default value is 30. Changing the value will not change the configuration until the Submit button is pressed.

**Maximum Requests** - This input field allows the user to enter the maximum requests for the selected port. The maximum requests value is the maximum number of times the authenticator state machine on this port will retransmit an EAPOL EAP Request/Identity before timing out the supplicant. The maximum requests value must be in the range of 1 to 10. The default value is 2. Changing the value will not change the configuration until the Submit button is pressed.

**Reauthentication Period (secs)**- This input field allows the user to enter the reauthentication period for the selected port. The reauthentication period is the value, in seconds, of the timer used by the authenticator state machine on this port to determine when reauthentication of the supplicant takes place. The reauthentication period must be a value in the range of 1 to 65535. The default value is 3600. Changing the value will not change the configuration until the Submit button is pressed.

**Reauthentication Enabled** - This field allows the user to enable or disable reauthentication of the supplicant for the specified port. The selectable values are 'true' and 'false'. If the value is 'true' reauthentication will occur. Otherwise, reauthentication will not be allowed. The default value is false. Changing the selection will not change the configuration until the Submit button is pressed.

### Command Buttons

**Initialize** - This button begins the initialization sequence on the selected port. This button is only selectable if the control mode is 'auto'. If the button is not selectable, it will be grayed out. Once this button is pressed, the action is immediate. It is not required to press the Submit button for the action to occur.



**Reauthenticate** - This button begins the reauthentication sequence on the selected port.

This button is only selectable if the control mode is 'auto'. If the button is not selectable, it will be grayed out. Once this button is pressed, the action is immediate. It is not required to press the Submit button for the action to occur.

**Submit** - Sends the updated screen to the switch and causes the changes to take effect on the switch but these changes will not be retained across a power cycle unless a save is performed.

**Refresh** - Update the information on the page.

Port Access Control Port Configuration

 Print
  Reload
  Help

---

Port	<input type="text" value="0/1"/>	
Control Mode	<input type="text" value="Auto"/>	
Quiet Period (secs)	<input type="text" value="60"/>	(0 to 65535)
Transmit Period (secs)	<input type="text" value="30"/>	(1 to 65535)
Guest VLAN ID	<input type="text" value="0"/>	(0 to 3965)
Guest VLAN Period	<input type="text" value="90"/>	(1 to 300)
Supplicant Timeout (secs)	<input type="text" value="30"/>	(1 to 65535)
Server Timeout (secs)	<input type="text" value="30"/>	(1 to 65535)
Maximum Requests	<input type="text" value="2"/>	(1 to 10)
Reauthentication Period (secs)	<input type="text" value="3600"/>	(1 to 65535)
Reauthentication Enabled	<input type="text" value="False"/>	

Controller time: 2008/6/6 10:24:1

### 11.2.4.1.3. Viewing each Port Access Control Configuration Information Page

#### Selection Criteria

**Port** - Selects the port to be displayed. When the selection is changed, a screen refresh will occur causing all fields to be updated for the newly selected port. All physical interfaces are valid.

#### Non-Configurable Data

**Control Mode** - Displays the configured control mode for the specified port. Options are:

*force unauthorized:* The authenticator port access entity (PAE) unconditionally sets the controlled port to unauthorized

*force authorized:* The authenticator PAE unconditionally sets the controlled port to authorized.

*auto:* The authenticator PAE sets the controlled port mode to reflect the outcome of the authentication exchanges between the supplicant, authenticator, and the authentication server.

**Quiet Period(secs)** - This field displays the configured quiet period for the selected port. This quiet period is the value, in seconds, of the timer used by the authenticator state

machine on this port to define periods of time in which it will not attempt to acquire a supplicant. The quiet period is the period for which the authenticator does not attempt to acquire a supplicant after a failed authentication exchange with the supplicant. The quiet period is a number in the range of 0 and 65535.

**Transmit Period(secs)** - This field displays the configured transmit period for the selected port. The transmit period is the value, in seconds, of the timer used by the authenticator state machine on the specified port to determine when to send an EAPOL EAP Request/Identity frame to the supplicant. The transmit period is a number in the range of 1 to 65535.

**Guest VLAN ID(secs)** - This field displays the configured guest Vlan ID for the selected port. The guest Vlan ID is a value of 0 to 3965.

**Guest VLAN Period(secs)** - This field displays the configured guest Vlan period for the selected port. The guest Vlan period is the value, in seconds, of the timer used by the GuestVlan Authentication. The guest Vlan period is a number in the range of 1 and 300.

**Supplicant Timeout(secs)** - This field displays the configured supplicant timeout for the selected port. The supplicant timeout is the value, in seconds, of the timer used by the authenticator state machine on this port to timeout the supplicant. The supplicant timeout is a value in the range of 1 to 65535.

**Server Timeout(secs)** - This field displays the configured server timeout for the selected port. The server timeout is the value, in seconds, of the timer used by the authenticator on this port to timeout the authentication server. The server timeout is a value in the range of 1 to 65535.

**Maximum Requests** - This field displays the configured maximum requests for the selected port. The maximum requests value is the maximum number of times the authenticator state machine on this port will retransmit an EAPOL EAP Request/Identity before timing out the supplicant. The maximum requests value is in the range of 1 to 10.

**Reauthentication Period(secs)** - This field displays the configured reauthentication period for the selected port. The reauthentication period is the value, in seconds, of the timer used by the authenticator state machine on this port to determine when reauthentication of the supplicant takes place. The reauthentication period is a value in the range of 1 to 65535.

**Reauthentication Enabled** - This field displays if reauthentication is enabled on the selected port. This is a configurable field. The possible values are 'true' and 'false'. If the value is 'true' reauthentication will occur. Otherwise, reauthentication will not be allowed.

**Control Direction** - This displays the control direction for the specified port. The control direction dictates the degree to which protocol exchanges take place between Supplicant and Authenticator. This affects whether the unauthorized controlled port exerts control over communication in both directions (disabling both incoming and outgoing frames) or just in the incoming direction (disabling only the reception of incoming frames). This field is not configurable on some platforms.

**Protocol Version** - This field displays the protocol version associated with the selected port. The only possible value is 1, corresponding to the first version of the 802.1x specification. This field is not configurable.

**PAE Capabilities** - This field displays the port access entity (PAE) functionality of the selected port. Possible values are "Authenticator" or "Supplicant". This field is not configurable.

**Authenticator PAE State** - This field displays the current state of the authenticator PAE state machine. Possible values are:

- "Initialize"
- "Disconnected"
- "Connecting"
- "Authenticating"
- "Authenticated"
- "Aborting"
- "Held"
- "ForceAuthorized"
- "ForceUnauthorized".



**Backend State** - This field displays the current state of the backend authentication state machine. Possible values are:

- "Request"
- "Response"
- "Success"
- "Fail"
- "Timeout"
- "Initialize"
- "Idle"

#### **Command Buttons**

**Refresh** - Update the information on the page.

Port Access Control Status

 Print
  Reload
  Help

---

Port	0/1 <input type="button" value="v"/>
Control Mode	auto
Quiet Period (secs)	60
Transmit Period (secs)	30
Guest VLAN ID	0
Guest VLAN Period	90
Supplicant Timeout (secs)	30
Server Timeout (secs)	30
Maximum Requests	2
Reauthentication Period (secs)	3600
Reauthentication Enabled	False
Control Direction	Both
Protocol Version	1
PAE Capabilities	Authenticator
Authenticator PAE State	Initialize
Backend State	Initialize

Controller time: 2008/6/6 10:35:13

#### 11.2.4.1.4. Viewing Access Control Summary Page

##### Non-Configurable Data

**Port** - Specifies the port whose settings are displayed in the current table row.

**Control Mode** - This field indicates the configured control mode for the port. Possible values are:

*Force Unauthorized:* The authenticator port access entity (PAE) unconditionally sets the controlled port to unauthorized.

*Force Authorized:* The authenticator PAE unconditionally sets the controlled port to authorized.

*Auto:* The authenticator PAE sets the controlled port mode to reflect the outcome of the authentication exchanges between the supplicant, authenticator, and the authentication server.

**Operating Control Mode** - This field indicates the control mode under which the port is actually operating. Possible values are:

ForceUnauthorized

ForceAuthorized

Auto

**Reauthentication Enabled** - This field shows whether reauthentication of the supplicant for the specified port is allowed. The possible values are 'true' and 'false'. If the value is

'true' reauthentication will occur. Otherwise, reauthentication will not be allowed.

**Port Status** - This field shows the authorization status of the specified port. The possible values are 'Authorized' and 'Unauthorized'.

### Command Buttons

**Refresh** - Update the information on the page.

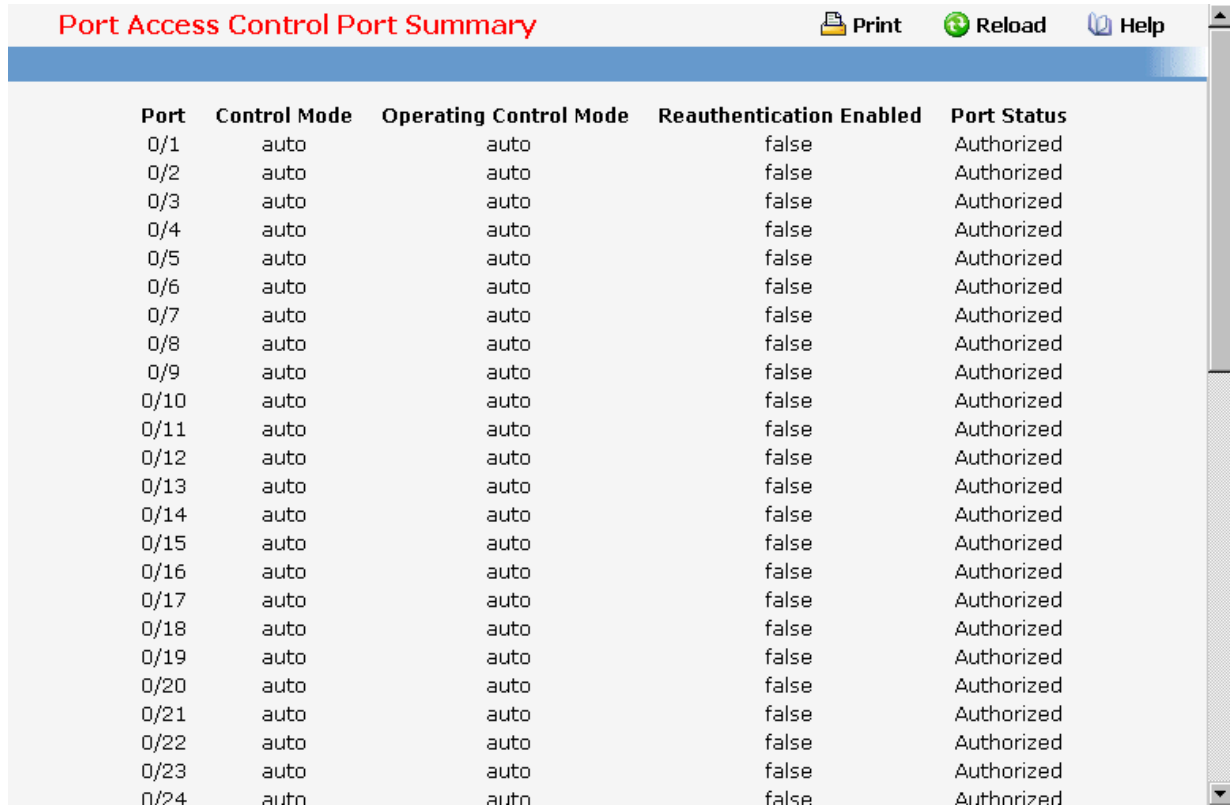

The screenshot shows a web interface titled "Port Access Control Port Summary". At the top right, there are buttons for "Print", "Reload", and "Help". Below the title bar is a table with the following columns: Port, Control Mode, Operating Control Mode, Reauthentication Enabled, and Port Status. The table lists 24 ports (0/1 to 0/24), all with "auto" for both Control Mode and Operating Control Mode, "false" for Reauthentication Enabled, and "Authorized" for Port Status.

Port	Control Mode	Operating Control Mode	Reauthentication Enabled	Port Status
0/1	auto	auto	false	Authorized
0/2	auto	auto	false	Authorized
0/3	auto	auto	false	Authorized
0/4	auto	auto	false	Authorized
0/5	auto	auto	false	Authorized
0/6	auto	auto	false	Authorized
0/7	auto	auto	false	Authorized
0/8	auto	auto	false	Authorized
0/9	auto	auto	false	Authorized
0/10	auto	auto	false	Authorized
0/11	auto	auto	false	Authorized
0/12	auto	auto	false	Authorized
0/13	auto	auto	false	Authorized
0/14	auto	auto	false	Authorized
0/15	auto	auto	false	Authorized
0/16	auto	auto	false	Authorized
0/17	auto	auto	false	Authorized
0/18	auto	auto	false	Authorized
0/19	auto	auto	false	Authorized
0/20	auto	auto	false	Authorized
0/21	auto	auto	false	Authorized
0/22	auto	auto	false	Authorized
0/23	auto	auto	false	Authorized
0/24	auto	auto	false	Authorized

#### 11.2.4.1.5. Viewing each Port Access Control Statistics Page

##### Selection Criteria

**Port** - Selects the port to be displayed. When the selection is changed, a screen refresh will occur causing all fields to be updated for the newly selected port. All physical interfaces are valid.

##### Non-Configurable Data

**EAPOL Frames Received** - This displays the number of valid EAPOL frames of any type that have been received by this authenticator.

**EAPOL Frames Transmitted** - This displays the number of EAPOL frames of any type that have been transmitted by this authenticator.

**EAPOL Start Frames Received** - This displays the number of EAPOL start frames that have been received by this authenticator.

**EAPOL Logoff Frames Received** - This displays the number of EAPOL logoff frames that have been received by this authenticator.

**Last EAPOL Frame Version** - This displays the protocol version number carried in the most recently received EAPOL frame.

**Last EAPOL Frame Source** - This displays the source MAC address carried in the most recently received EAPOL frame.

**EAP Response/Id Frames Received** - This displays the number of EAP response/identity frames that have been received by this authenticator.

**EAP Response Frames Received** - This displays the number of valid EAP response frames (other than resp/id frames) that have been received by this authenticator.

**EAP Request/Id Frames Transmitted** - This displays the number of EAP request/identity frames that have been transmitted by this authenticator.

**EAP Request Frames Transmitted** - This displays the number of EAP request frames (other than request/identity frames) that have been transmitted by this authenticator.

**Invalid EAPOL Frames Transmitted** - This displays the number of EAPOL frames that have been received by this authenticator in which the frame type is not recognized.

**EAP Length Error Frames Received** - This displays the number of EAPOL frames that have been received by this authenticator in which the frame type is not recognized.



### Command Buttons

**Refresh** - Update the information on the page.

**Clear All** - This button resets all statistics for all ports to 0. There is no confirmation prompt. When this button is pressed, the stats are immediately cleared.

**Clear** - This button resets the statistics for the selected port. There is no confirmation prompt. When this button is pressed, the stats are immediately cleared.

Port Access Control Statistics

 Print
  Reload
  Help

Port	0/1 ▾
EAPOL Frames Received	0
EAPOL Frames Transmitted	0
EAPOL Start Frames Received	0
EAPOL Logoff Frames Received	0
Last EAPOL Frame Version	0
Last EAPOL Frame Source	00:00:00:00:00:00
EAP Response/ID Frames Received	0
EAP Response Frames Received	0
EAP Request/ID Frames Transmitted	0
EAP Request Frames Transmitted	0
Invalid EAPOL Frames Received	0
EAPOL Length Error Frames Received	0

Refresh
Clear All
Clear

#### 11.2.4.1.6. Defining Access Control User Login Page

##### Selection Criteria

**Users** - Selects the user name that will use the selected login list for 802.1x port security.

##### Configurable Data

**Login** - Selects the login to apply to the specified user. All configured logins are displayed.

##### Command Buttons

**Submit** - Sends the updated screen to the switch and causes the changes to take effect on the switch but these changes will not be retained across a power cycle unless a save is performed.

**Refresh** - Update the information on the page.

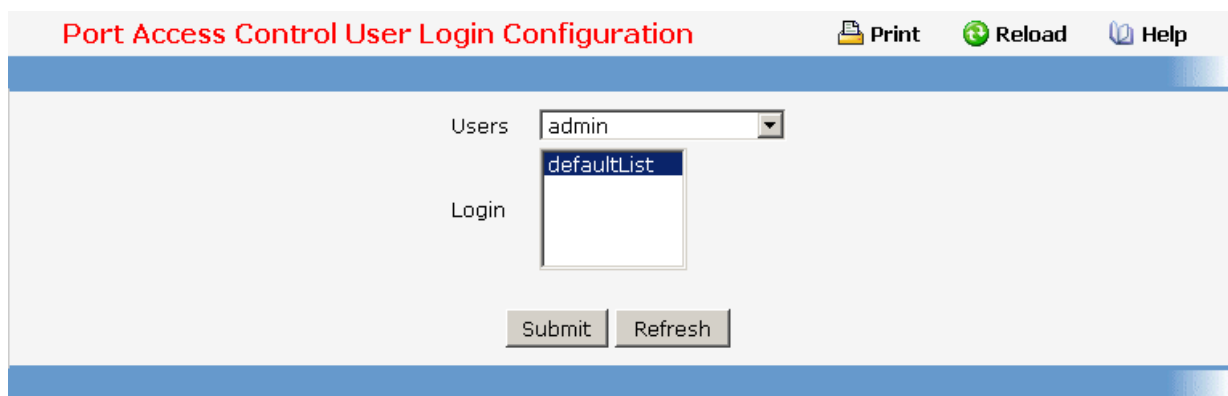

Port Access Control User Login Configuration

Print Reload Help

Users admin

Login defaultList

Submit Refresh

#### 11.2.4.1.7. Defining each Port Access Privileges Page

##### Selection Criteria

**Port** - Selects the port to configure.

##### Configurable Data

**Users** - Selects the users that have access to the specified port or ports.

##### Command Buttons

**Submit** - Sends the updated screen to the switch and causes the changes to take effect on the switch but these changes will not be retained across a power cycle unless a save is performed.

**Refresh** - Update the information on the page.



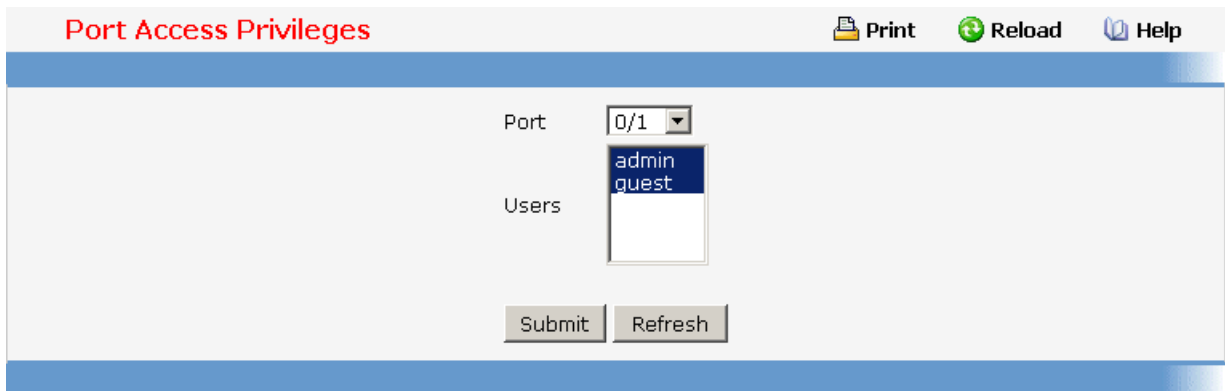

#### 11.2.4.1.8. Viewing each Port Access Privileges Summary Page

##### Non-Configurable Data

**Port** - Displays the port in Slot/Port format.

**Users** - Displays the users that have access to the port.

##### Command Buttons

**Refresh** - Update the information on the page.

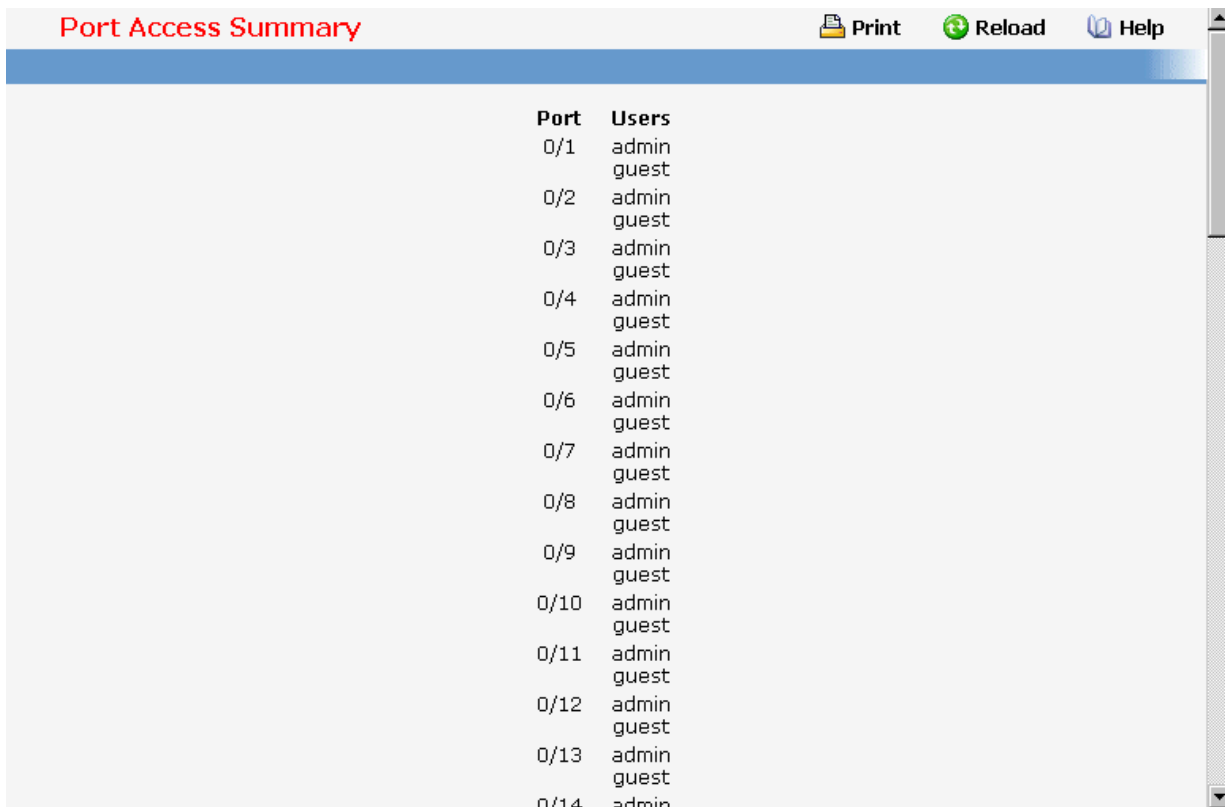

Port	Users
0/1	admin guest
0/2	admin guest
0/3	admin guest
0/4	admin guest
0/5	admin guest
0/6	admin guest
0/7	admin guest
0/8	admin guest
0/9	admin guest
0/10	admin guest
0/11	admin guest
0/12	admin guest
0/13	admin guest
0/14	admin

## 11.2.4.2 Managing RADIUS

### 11.2.4.2.1. Configuring RADIUS Configuration Page

#### Configurable Data

**Max Number of Retransmits** - The value of the maximum number of times a request packet is retransmitted. The valid range is 1 - 15. Consideration to maximum delay time should be given when configuring RADIUS maxretransmit and RADIUS timeout. If multiple RADIUS servers are configured, the max retransmit value on each will be exhausted before the next server is attempted. A retransmit will not occur until the configured timeout value on that server has passed without a response from the RADIUS server. Therefore, the maximum delay in receiving a response from the RADIUS application equals the sum of (retransmit times timeout) for all configured servers. If the RADIUS request was generated by a user login attempt, all user interfaces will be blocked until the RADIUS application returns a response.

**Timeout Duration (secs)** - The timeout value, in seconds, for request retransmissions. The valid range is 1 - 30. Consideration to maximum delay time should be given when configuring RADIUS maxretransmit and RADIUS timeout. If multiple RADIUS servers are configured, the max retransmit value on each will be exhausted before the next server is attempted. A retransmit will not occur until the configured timeout value on that server has passed without a response from the RADIUS server. Therefore, the maximum delay in receiving a response from the RADIUS application equals the sum of (retransmit times timeout) for all configured servers. If the RADIUS request was generated by a user login attempt, all user interfaces will be blocked until the RADIUS application returns a response.

**Accounting Mode** - Selects if the RADIUS accounting mode is enabled or disabled.

**Radius Attribute 4 (NAS-IP Address)** - Select if the Radius Attribute 4 (NAS-IP Address) inclusion in Radius Requests is enabled or disabled. Mention explicitly the IP address to be sent as NAS-IP Address to the Radius servers. If not mentioned, then the outgoing interface IP address that is used to send the packet to the Radius server is added as NAS-IP Address.

#### Non-Configurable Data

**Current Server IP Address** - The IP address of the current server. This field is blank if no servers are configured.



**Number of Configured Servers** - The number of RADIUS servers that have been configured. This value will be in the range of 0 and 3.

#### Command Buttons

**Submit** - Sends the updated screen to the switch and causes the changes to take effect on the switch but these changes will not be retained across a power cycle unless a save is performed.

**Refresh** - Update the information on the page.

RADIUS Configuration

 Print
  Reload
  Help

---

Current Server Host Address

Number of Configured Servers 0

Max Number of Retransmits  (1 to 15)

Timeout Duration (secs)  (1 to 30)

Accounting Mode

Radius Attribute 4 (NAS-IP Address)   (X.X.X.X)

---

Controller time: 2008/6/6 12:55:43

### 11.2.4.2.2. Configuring RADIUS Server Configuration Page

#### Selection Criteria

**RADIUS Server IP Address** - Selects the RADIUS server to be configured. Select add to add a server.

#### Configurable Data

**IP Address** - The IP address of the server being added.

**Port** - The UDP port used by this server. The valid range is 0 - 65535.

**Secret** - The shared secret for this server. This is an input field only.

**Apply** - The Secret will only be applied if this box is checked. If the box is not checked, anything entered in the Secret field will have no affect and will not be retained. This field is only displayed if the user has READWRITE access.

**Primary Server** - Sets the selected server to the Primary or Secondary server.

**Message Authenticator** - Enable or disable the message authenticator attribute for the selected server.

#### Non-Configurable Data

**Current** - Indicates if this server is currently in use as the authentication server.

**Secret Configured** - Indicates if the shared secret for this server has been configured.



#### Command Buttons

**Submit** - Sends the updated screen to the switch and causes the changes to take effect on the switch but these changes will not be retained across a power cycle unless a save is performed.

**Remove** - Remove the selected server from the configuration. This button is only available to READWRITE users. These changes will not be retained across a power cycle unless a save is performed.

**Refresh** - Update the information on the page.

RADIUS Server Configuration

 Print
  Reload
  Help

---

RADIUS Server IP Address	192.168.2.174	
Port	1812	(0 to 65535)
Secret	<input type="text"/>	<input type="checkbox"/> Apply
Primary Server	No	
Message Authenticator	Enable	
Secret Configured	No	
Current	Yes	

### 11.2.4.2.3. Viewing RADIUS Server Statistics Page

#### Selection Criteria

**RADIUS Server IP Address** - Selects the IP address of the RADIUS server for which to display statistics.

#### Non-Configurable Data

**Round Trip Time (secs)** - The time interval, in hundredths of a second, between the most recent Access-Reply/Access-Challenge and the Access-Request that matched it from this RADIUS authentication server.

**Access Requests** - The number of RADIUS Access-Request packets sent to this server. This number does not include retransmissions.

**Access Retransmissions** - The number of RADIUS Access-Request packets retransmitted to this server.

**Access Accepts** - The number of RADIUS Access-Accept packets, including both valid and invalid packets that were received from this server.

**Access Rejects** - The number of RADIUS Access-Reject packets, including both valid and invalid packets that were received from this server.

**Access Challenges** - The number of RADIUS Access-Challenge packets, including both valid and invalid packets that were received from this server.

**Malformed Access Responses** - The number of malformed RADIUS Access-Response packets received from this server. Malformed packets include packets with an invalid length. Bad authenticators or signature attributes or unknown types are not included as malformed access-responses.

**Bad Authenticators** - The number of RADIUS Access-Response packets containing invalid authenticators or signature attributes received from this server.

**Pending Requests** - The number of RADIUS Access-Request packets destined for this server that have not yet timed out or received a response.

**Timeouts** - The number of authentication timeouts to this server.

**Unknown Types** - The number of RADIUS packets of unknown type which were received



from this server on the authentication port.

**Packets Dropped** - The number of RADIUS packets received from this server on the authentication port and dropped for some other reason.

### Command Buttons

**Refresh** - Update the information on the page.

RADIUS Server Statistics

 **Print**
 **Reload**
 **Help**

RADIUS Server IP Address	192.168.2.174 ▾
Round Trip Time (secs)	0.00
Access Requests	0
Access Retransmissions	0
Access Accepts	0
Access Rejects	0
Access Challenges	0
Malformed Access Responses	0
Bad Authenticators	0
Pending Requests	0
Timeouts	0
Unknown Types	0
Packets Dropped	0

#### 11.2.4.2.4. Defining RADIUS Accounting Server Configuration Page

##### Selection Criteria

**Accounting Server IP Address** - Selects the accounting server for which data is to be displayed or configured. If the add item is selected, a new accounting server can be configured.

##### Configurable Data

**IP Address** - The IP address of the accounting server to add. This field is only configurable if the add item is selected.

**Port** - Specifies the UDP Port to be used by the accounting server. The valid range is 0 - 65535. If the user has READONLY access, the value is displayed but cannot be changed.

**Secret** - Specifies the shared secret to use with the specified accounting server. This field is only displayed if the user has READWRITE access.

**Apply** - The Secret will only be applied if this box is checked. If the box is not checked, anything entered in the Secret field will have no affect and will not be retained. This field is only displayed if the user has READWRITE access.

##### Non-Configurable Data

**Secret Configured** - Indicates if the secret has been configured for this accounting server.

### Command Buttons

**Submit** - Sends the updated screen to the switch and causes the changes to take effect on the switch but these changes will not be retained across a power cycle unless a save is performed.

**Remove** - Remove the selected accounting server from the configuration. This button is only available to READWRITE users. These changes will not be retained across a power cycle unless a save is performed.

**Refresh** - Update the information on the page.

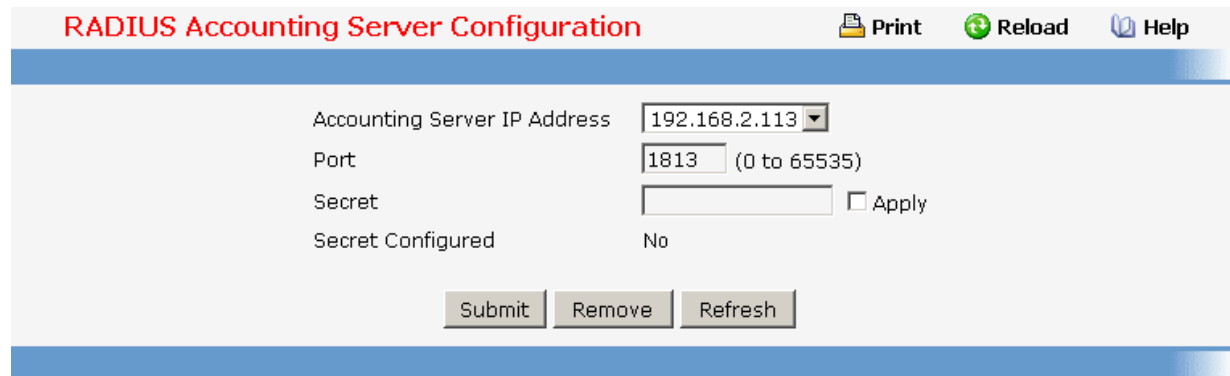

#### 11.2.4.2.5. Viewing RADIUS Accounting Server Statistics Page

##### Non-Configurable Statistics

**Accounting Server IP Address** - Identifies the accounting server associated with the statistics.

**Round Trip Time (secs)** - Displays the time interval, in hundredths of a second, between the most recent Accounting-Response and the Accounting-Request that matched it from this RADIUS accounting server.

**Accounting Requests** - Displays the number of RADIUS Accounting-Request packets sent not including retransmissions.

**Accounting Retransmissions** - Displays the number of RADIUS Accounting-Request packets retransmitted to this RADIUS accounting server.

**Accounting Responses** - Displays the number of RADIUS packets received on the accounting port from this server.

**Malformed Accounting Responses** - Displays the number of malformed RADIUS Accounting-Response packets received from this server. Malformed packets include packets with an invalid length. Bad authenticators and unknown types are not included as malformed accounting responses.

**Bad Authenticators** - Displays the number of RADIUS Accounting-Response packets that contained invalid authenticators received from this accounting server.

**Pending Requests** - Displays the number of RADIUS Accounting-Request packets sent to this server that have not yet timed out or received a response.

**Timeouts** - Displays the number of accounting timeouts to this server.

**Unknown Types** - Displays the number of RADIUS packets of unknown type that were received from this server on the accounting port.

**Packets Dropped** - Displays the number of RADIUS packets that were received from this server on the accounting port and dropped for some other reason.

**Command Buttons**

**Refresh** - Update the information on the page.

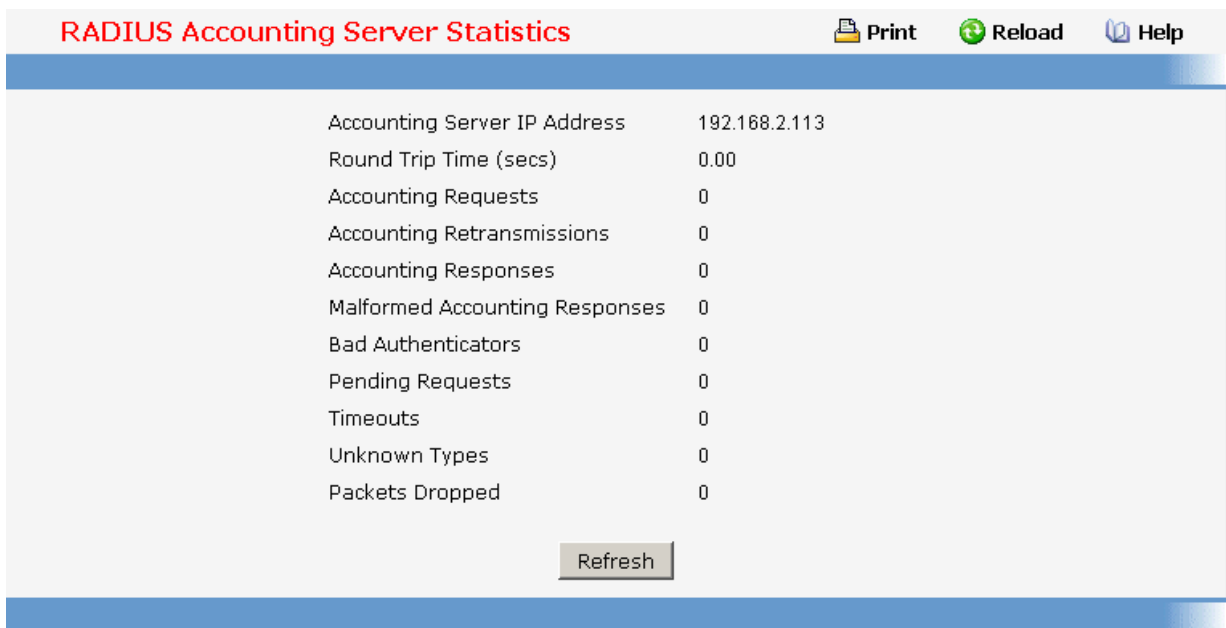

The screenshot shows a web interface titled "RADIUS Accounting Server Statistics". At the top right, there are three icons: a printer for "Print", a circular arrow for "Reload", and a question mark for "Help". The main content area contains a table with the following data:

Accounting Server IP Address	192.168.2.113
Round Trip Time (secs)	0.00
Accounting Requests	0
Accounting Retransmissions	0
Accounting Responses	0
Malformed Accounting Responses	0
Bad Authenticators	0
Pending Requests	0
Timeouts	0
Unknown Types	0
Packets Dropped	0

At the bottom center of the table area, there is a "Refresh" button.

**11.2.4.2.6. Resetting All RADIUS Statistics Page**

**Command Buttons**

**Clear All RADIUS Statistics** - This button will clear the accounting server, authentication server, and RADIUS statistics.

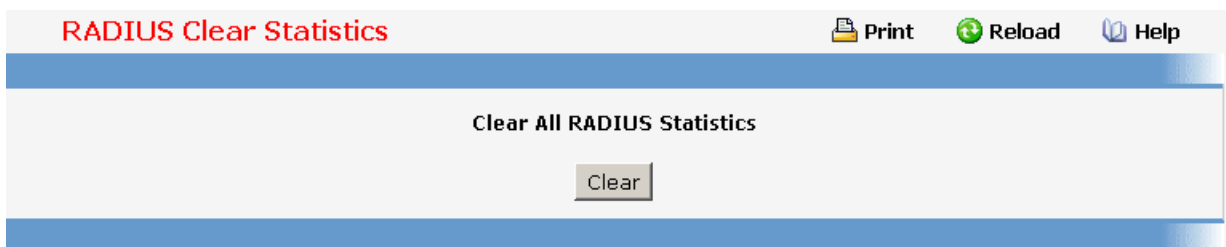

The screenshot shows a web interface titled "RADIUS Clear Statistics". At the top right, there are three icons: a printer for "Print", a circular arrow for "Reload", and a question mark for "Help". The main content area contains a single button labeled "Clear All RADIUS Statistics". Below this button is a "Clear" button.

**11.2.4.3 Defining TACACS+ Configuration**

### 11.2.4.3.1. Configuring TACACS Configuration Page

#### Configurable Data

**Key String** - Specifies the authentication and encryption key for TACACS+ communications between the device and the TACACS+ server. The valid range is 0-128 characters. The key must match the key configured on the TACACS+ server.

**Connection Timeout** - The maximum number of seconds allowed to establish a TCP connection between the device and the TACACS+ server.

#### Command Buttons

**Submit** - Send the updated screen to the switch and cause the changes to take effect on the switch but these changes will not be retained across a power cycle unless a save is performed.

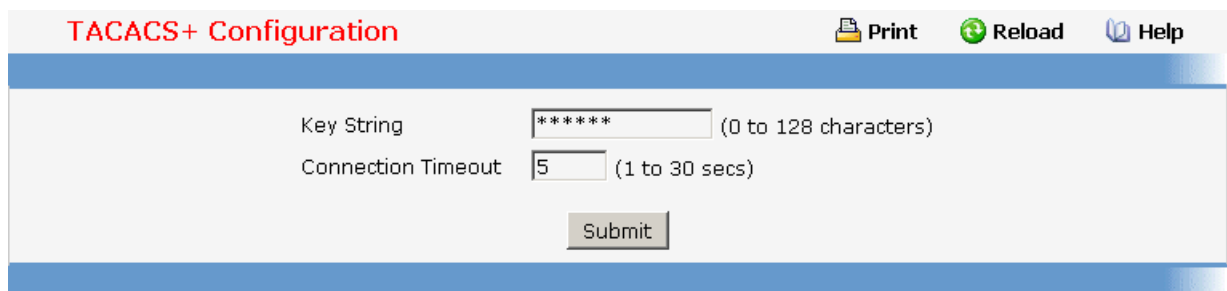

### 11.2.4.3.2. Configuring TACACS+ Server Configuration Page

#### Selection Criteria

**TACACS+ Server** Selects the TACACS+ server for which data is to be displayed or configured. If the add item is selected, a new TACACS server can be configured.

#### Configurable Data

**IP Address** - Specifies the TACACS+ Server IP address.

**Priority** - Specifies the order in which the TACACS+ servers are used. It should be within the range 0-65535.

**Port** - Specifies the authentication port. It should be within the range 0-65535.

**Key String** - Specifies the authentication and encryption key for TACACS+ communications between the device and the TACACS+ server. The valid range is 0-128 characters. The key must match the encryption used on the TACACS+ server.

**Connection Timeout** - The amount of time that passes before the connection between the device and the TACACS+ server time out. The range is between 1-30.





## Command Buttons

**Submit** - Send the updated screen to the switch and cause the changes to take effect on the switch but these changes will not be retained across a power cycle unless a save is performed.

**Remove** - Remove the selected server from the configuration.

**TACACS+ Server Configuration**

 **Print**
 **Reload**
 **Help**

---

TACACS+ Server

Priority  (0 to 65535)

Port  (0 to 65535)

Key String  (0 to 128 characters)

Connection Timeout  (1 to 30 secs)

---

## 11.2.4.4 Defining IP Filter Configuration

### 11.2.4.4.1. IP Filter Configuration Page

Management IP filter designates stations that are allowed to make configuration changes to the Switch. Select up to five management stations used to manage the Switch. If you choose to define one or more designated management stations, only the chosen stations, as defined by IP address, will be allowed management privilege through the web manager, Telnet session, Secure Shell (SSH) or Secure Socket Layer (SSL) for secure HTTP.



#### Configurable Data

**Filter Address 1~5** - Stations that are allowed to make configuration changes to the Switch.

#### Command Buttons

**Submit** - Send the updated screen to the switch. Changes take effect on the switch but these changes will not be retained across a power cycle unless a save is performed.

IP Filter Configuration

 Print
  Reload
  Help

---

Admin Mode	<input type="text" value="Disable"/>	
Filter Address 1	<input type="text" value="0.0.0.0"/>	(0.0.0.0 = Disable)
Filter Address 2	<input type="text" value="0.0.0.0"/>	(0.0.0.0 = Disable)
Filter Address 3	<input type="text" value="0.0.0.0"/>	(0.0.0.0 = Disable)
Filter Address 4	<input type="text" value="0.0.0.0"/>	(0.0.0.0 = Disable)
Filter Address 5	<input type="text" value="0.0.0.0"/>	(0.0.0.0 = Disable)

---

### 11.2.4.5 Defining Secure Http Configuration

#### 11.2.4.5.1. Secure HTTP Configuration Page

##### Configurable Data

**HTTPS Admin Mode** - This field is used to enable or disable the Administrative Mode of Secure HTTP. The currently configured value is shown when the web page is displayed. The default value is disabled.

**TLS Version 1** - This field is used to enable or disable Transport Layer Security Version 1.0. The currently configured value is shown when the web page is displayed. The default value is enabled.

**SSL Version 3** - This field is used to enable or disable Secure Sockets Layer Version 3.0. The currently configured value is shown when the web page is displayed. The default value is enabled.

**HTTPS Port Number** - This field is used to set the HTTPS Port Number. The value must be in the range of 1 to 65535. Port 443 is the default value. The currently configured value is shown when the web page is displayed.

**HTTPS Session Soft Timeout** - This field is used to set the inactivity timeout for HTTPS sessions. The value must be in the range of (1 to 60) minutes. The default value is 5 minutes. The currently configured value is shown when the web page is displayed.

**HTTPS Session Hard Timeout** - This field is used to set the hard timeout for HTTPS sessions. This timeout is unaffected by the activity level of the session. The value must be in the range of (1 to 168) hours. The default value is 24 hours. The currently configured value is shown when the web page is displayed.

**Maximum Number of HTTPS Sessions** - This field is used to set the maximum allowable number of HTTPS sessions. The value must be in the range of (0 to 16). The default value is 16. The currently configured value is shown when the web page is displayed.

##### Command Buttons

**Submit** - Send the updated screen to the switch. Changes take effect on the switch but these changes will not be retained across a power cycle unless a save is performed.

**Download Certificates** - Link to the File Transfer page for the SSL Certificate download. Note that to download SSL Certificate files SSL must be administratively disabled.

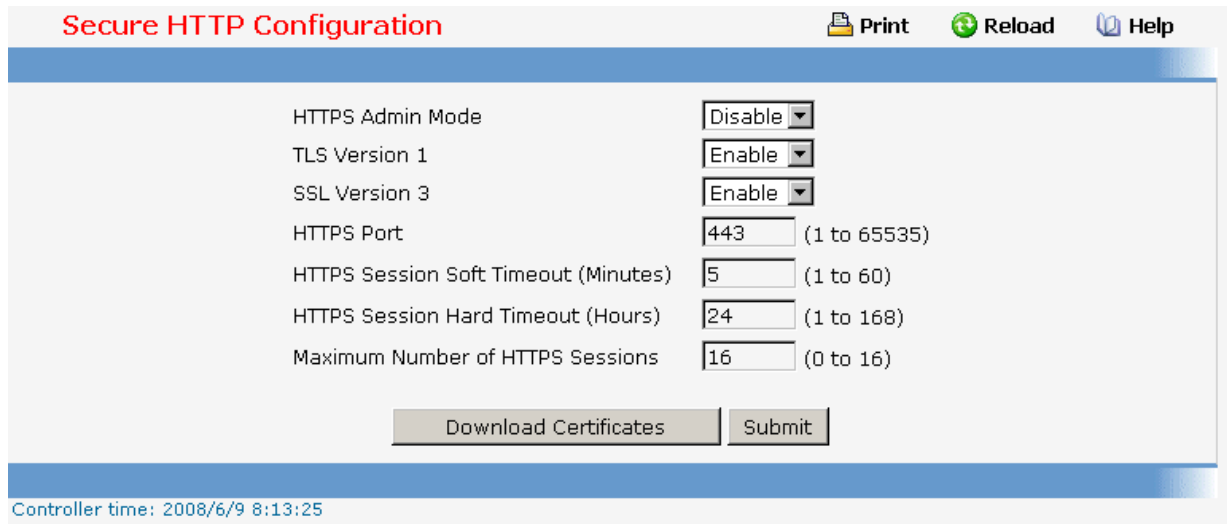

**Secure HTTP Configuration** Print Reload Help

HTTPS Admin Mode	<input type="text" value="Disable"/>	
TLS Version 1	<input type="text" value="Enable"/>	
SSL Version 3	<input type="text" value="Enable"/>	
HTTPS Port	<input type="text" value="443"/>	(1 to 65535)
HTTPS Session Soft Timeout (Minutes)	<input type="text" value="5"/>	(1 to 60)
HTTPS Session Hard Timeout (Hours)	<input type="text" value="24"/>	(1 to 168)
Maximum Number of HTTPS Sessions	<input type="text" value="16"/>	(0 to 16)

Controller time: 2008/6/9 8:13:25

#### 11.2.4.6 Defining Secure Shell Configuration

##### 11.2.4.6.1. Configuring Secure Shell Configuration Page

###### Configurable Data

**Admin Mode** - This select field is used to Enable or Disable the administrative mode of SSH. The currently configured value is shown when the web page is displayed. The default value is Disable.

**SSH Version 1** - This select field is used to Enable or Disable Protocol Level 1 for SSH. The currently configured value is shown when the web page is displayed. The default value is Enable.

**SSH Version 2** - This select field is used to Enable or Disable Protocol Level 2 for SSH. The currently configured value is shown when the web page is displayed. The default value is Enable.

**Maximum Number of SSH Sessions Allowed** - This select field is used to configure the maximum number of inbound SSH sessions allowed on the switch. The currently configured value is shown when the web page is displayed. The range of acceptable values for this field is (0-5).

**SSH Session Timeout (Minutes)** - This text field is used to configure the inactivity timeout value for incoming SSH sessions to the switch. The acceptable range for this value is (1-160) minutes.

### Non-Configurable Data



**SSH Connections in Use** - Displays the number of SSH connections currently in use in the system.

### Command Buttons

**Submit** - Send the updated screen to the switch. Changes take effect on the switch but these changes will not be retained across a power cycle unless a save is performed.

**Download Host Keys** - Link to the File Transfer page for the Host Key download. Note that to download SSH key files SSH must be administratively disabled and there can be no active SSH sessions.

Secure Shell Configuration

 Print
  Reload
  Help

---

Admin Mode	<input type="text" value="Disable"/>
SSH Version 1	<input type="text" value="Enable"/>
SSH Version 2	<input type="text" value="Enable"/>
SSH Connections Currently in Use	0
Maximum number of SSH Sessions Allowed	<input type="text" value="5"/>
SSH Session Timeout (minutes)	<input type="text" value="5"/> (1 to 160)

## 11.2.5 IPv6 Menu



### 11.2.5.1 Configuring IPv6 Global Configuration Page

#### Configurable Data

**IPv6 Unicast Routing** - Globally enable or disable IPv6 unicast routing on the entity.

**IPv6 Forwarding** - Enable or disable forwarding of IPv6 frames on the router.

IPv6 Configuration

 Print
  Reload
  Help

---

IPv6 Unicast Routing	<input type="text" value="Disable"/>
IPv6 Forwarding	<input type="text" value="Enable"/>

### 11.2.5.2 Configuring IPv6 Interface Configuration Page

#### Selection Criteria

**Interface** - Selects the interface to be configured. When the selection is changed, a screen refresh will occur causing all fields to be updated for the newly selected port. All physical interfaces are valid.

**IPv6 Address** - Specifies IPv6 prefix with prefix length for an interface. When the selection is changed screen is refreshed and valid lifetime, preferred lifetime, on-link flag and autonomous flag will be updated for selected IPv6 address.

#### Configurable Data

**IPv6 Mode** - When ipv6 mode is enabled, interface is capable of ipv6 operation without a global address. In this case, an eui-64 based link-local address is used. This selector lists the two options for ipv6 mode: enable and disable. Default value is disable.

**IPv6 Address** - Specifies IPv6 prefix with prefix length for an interface.

**EUI-64** - Specifies 64 bit unicast prefix.

**Valid Lifetime** - Specifies router advertisement per prefix time to consider prefix valid for purposes of on link determination. Valid lifetime must be in the range (0 to 4294967295)

**Preferred Lifetime** - Specifies router advertisement per prefix time. An autoconfigured address generated from this prefix is preferred. Preferred lifetime must be in range (0 to -1)

**OnLink Flag** - Specifies selected prefix can be used for on-link determination. Default value is enable. This selector lists the two options for on-link flag: enable and disable.

**Autonomous Flag** - Specifies selected prefix can be used for autonomous address configuration. Default value is disable. This selector lists the two options for autonomous flag: enable and disable.

**Routing Mode** - Specifies routing mode of an interface. This selector lists the two options for routing mode: enable and disable. Default value is disable.

**Administrative Mode** - Specifies administrative mode of an interface. This selector lists the two options for administrative mode: enable and disable. Default value is enable.

**IPv6 Routing Operational Mode** - Specifies operational state of an interface. Default value is disable.

**Maximum Transmit Unit** - Specifies maximum transmit unit on an interface. If the value is 0 then this interface is not enabled for routing. It is not valid to set this value to 0 if routing is enabled. Range of MTU is (1280 to 1500)

**Duplicate Address Detection** - Specifies number of duplicate address detections transmits on an interface. DAD transmits values must be in range (0 to 600)

**Neighbor solicit Interval** - Specifies retransmission time field of router advertisement sent from the interface. A value of 0 means interval is not specified for router. Range of neighbor solicit interval is (1000 to 4294967295)

**Router Lifetime** - Specifies router advertisement lifetime field sent from the interface. This value must be greater than or equal to maximum advertisement interval. 0 means do not use router as default router. Range of router lifetime is (0 to 9000)

**Reachable Time** - Specifies router advertisement time to consider neighbor reachable after ND confirmation. Range of reachable time is (0 to 3600000)

**Router Advertisement Interval** - Specifies maximum time allowed between sending router advertisements from the interface. Default value is 600. Range of maximum advertisement interval is (4 to 1800)

**Managed Config Flag** - Specifies router advertisement managed address configuration flag. When true, end nodes use DHCPV6. When false end nodes autoconfigure addresses. Default value of managed flag is disable.

**Other Config Flag** - Specifies router advertisement other stateful configuration flag. Default value of other config flag is disable.

**Suppress Flag** - Specifies router advertisement suppression on an interface. Default value of suppress flag is disable.

### Command Buttons

**Submit** - Send the updated configuration to the switch. Configuration changes take effect immediately. These changes will not be retained across a power cycle unless a save is performed.

**Delete** - Delete the IPv6 Address configured on an interface.

Interface	<input type="text" value="0/1"/>
IPv6 Mode	<input type="text" value="Disable"/>
IPv6 Prefix	<input type="text" value="Add"/>
IPv6 Prefix	<input type="text"/> <input type="checkbox"/> EUI64
Valid Lifetime by Prefix	<input type="text"/> (0 to 4294967295)
Preferred Lifetime by Prefix	<input type="text"/> (0 to 4294967295)
Onlink Flag by Prefix	<input type="text" value="Enable"/>
Autonomous Flag by Prefix	<input type="text" value="Enable"/>
Current State by Prefix	
Routing Mode	<input type="text" value="Disable"/>
Administrative Mode	<input type="text" value="Enable"/>
IPv6 Routing Operational Mode	Disable
Interface Maximum Transmit Unit	<input type="text" value="0"/> (1280 to 1500) Enter 0 to unconfigure
Router Duplicate Address Detection Transmits	<input type="text" value="1"/> (0 to 600)
Router Advertisement NS Interval	<input type="text" value="0"/> (1000 to 4294967295) Enter 0 to unconfigure
Router Lifetime Interval	<input type="text" value="1800"/> (0 to 9000)
Router Advertisement Reachable Time	<input type="text" value="0"/> (0 to 3600000)
Router Advertisement Interval	<input type="text" value="600"/> (4 to 1800)
Router Advertisement Managed Config Flag	<input type="text" value="Disable"/>
Router Advertisement Other Config Flag	<input type="text" value="Disable"/>
Router Advertisement Suppress Flag	<input type="text" value="Disable"/>
<input type="button" value="Submit"/>	

### 11.2.5.3 Viewing IPv6 Interface Summary Page

#### Non-Configurable Data

**Interface** - Specifies the interface whose settings are displayed in the current table row.

**Routing Mode** - Specifies routing mode of an interface.

**Administrative Mode** - Specifies administrative mode of an interface.

**Operational Mode** - Specifies operational mode of an interface.

**IPv6 Prefix/PrefixLength** - Specifies configured IPv6 addresses on an interface.

**State** - Specifies whether an interface is active or not.

#### Command Buttons

**Refresh** - Refreshes the screen with most recent data.

IPv6 Interface Summary					
Interface	Routing Mode	Admin Mode	Operational Mode	IPv6 Prefix/PrefixLength	State
0/1	Disabled	Enabled	Disabled		
0/2	Disabled	Enabled	Disabled		
0/3	Disabled	Enabled	Disabled		
0/4	Disabled	Enabled	Disabled		
0/5	Disabled	Enabled	Disabled		
0/6	Disabled	Enabled	Disabled		
0/7	Disabled	Enabled	Disabled		
0/8	Disabled	Enabled	Disabled		
0/9	Disabled	Enabled	Disabled		
0/10	Disabled	Enabled	Disabled		
0/11	Disabled	Enabled	Disabled		
0/12	Disabled	Enabled	Disabled		
0/13	Disabled	Enabled	Disabled		
0/14	Disabled	Enabled	Disabled		
0/15	Disabled	Enabled	Disabled		
0/16	Disabled	Enabled	Disabled		
0/17	Disabled	Enabled	Disabled		
0/18	Disabled	Enabled	Disabled		
0/19	Disabled	Enabled	Disabled		
0/20	Disabled	Enabled	Disabled		
0/21	Disabled	Enabled	Disabled		
0/22	Disabled	Enabled	Disabled		
0/23	Disabled	Enabled	Disabled		
0/24	Disabled	Enabled	Disabled		

#### 11.2.5.4 Viewing IPv6 Interface Statistics Page

##### Selection Criteria

**Interface** - Selects the interface to be configured. When the selection is changed, a screen refresh will occur causing all fields to be updated for the newly selected port.

##### Non-Configurable Data

###### IPv6 Statistics

**Total Datagrams Received** - The total number of input datagrams received by the interface, including those received in error.

**Received Datagrams Locally Delivered** - The total number of datagrams successfully delivered to IPv6 user-protocols (including ICMP). This counter is incremented at the interface to which these datagrams were addressed which might not be necessarily the input interface for some of the datagrams.

**Received Datagrams Discarded Due To Header Errors** - The number of input datagrams discarded due to errors in their IPv6 headers, including version number mismatch, other format errors, hop count exceeded, errors discovered in processing their IPv6 options, etc.



**Received Datagrams Discarded Due To MTU** - The number of input datagrams that could not be forwarded because their size exceeded the link MTU of outgoing interface.

**Received Datagrams Discarded Due To No Route** - The number of input datagrams discarded because no route could be found to transmit them to their destination.

**Received Datagrams With Unknown Protocol** - The number of locally-addressed datagrams received successfully but discarded because of an unknown or unsupported protocol. This counter is incremented at the interface to which these datagrams were addressed which might not be necessarily the input interface for some of the datagrams.

**Received Datagrams Discarded Due To Invalid Address** - The number of input datagrams discarded because the IPv6 address in their IPv6 header's destination field was not a valid address to be received at this entity. This count includes invalid addresses (e.g., ::0) and unsupported addresses (e.g., addresses with unallocated prefixes). For entities which are not IPv6 routers and therefore do not forward datagrams, this counter includes datagrams discarded because the destination address was not a local address.

**Received Datagrams Discarded Due To Truncated Data** - The number of input datagrams discarded because datagram frame didn't carry enough data.

**Received Datagrams Discarded Other** - The number of input IPv6 datagrams for which no problems were encountered to prevent their continued processing, but which were discarded (e.g., for lack of buffer space). Note that this counter does not include any datagrams discarded while awaiting re-assembly.

**Received Datagrams Reassembly Required** - The number of IPv6 fragments received which needed to be reassembled at this interface. Note that this counter is incremented at the interface to which these fragments were addressed which might not be necessarily the input interface for some of the fragments.

**Datagrams Successfully Reassembled** - The number of IPv6 datagrams successfully reassembled. Note that this counter is incremented at the interface to which these datagrams were addressed which might not be necessarily the input interface for some of the fragments.

**Datagrams Failed To Reassemble** - The number of failures detected by the IPv6 reassembly algorithm (for whatever reason: timed out, errors, etc.). Note that this is not necessarily a count of discarded IPv6 fragments since some algorithms (notably the algorithm in RFC 815) can lose track of the number of fragments by combining them as they are received. This counter is incremented at the interface to which these fragments were addressed which might not be necessarily the input interface for some of the fragments.

**Datagrams Forwarded** - The number of output datagrams which this entity received and forwarded to their final destinations. In entities which do not act as IPv6 routers, this counter will include only those packets which were Source-Routed via this entity, and the Source-Route processing was successful. Note that for a successfully forwarded datagram the counter of the outgoing interface is incremented.

**Datagrams Locally Trasmitted** - The number of datagrams which this entity has successfully transmitted from this output interface.

**Datagrams Transmit Failed** - The number of datagrams which this entity failed to transmit successfully.

**Datagrams Successfully Fragmented** - The number of IPv6 datagrams that have been successfully fragmented at this output interface.

**Datagrams Failed To Fragment** - The number of output datagrams that could not be fragmented at this interface.

**Datagrams Fragments Created** - The number of output datagram fragments that have been generated as a result of fragmentation at this output interface.

**Multicast Datagrams Received** - The number of multicast packets received by the interface.

**Multicast Datagrams Transmitted** - The number of multicast packets transmitted by the interface.

### ICMPv6 Statistics

**Total ICMPv6 Messages Received** - The total number of ICMP messages received by the interface which includes all those counted by `ipv6IfIcmpInErrors`. Note that this interface is the interface to which the ICMP messages were addressed which may not be necessarily the input interface for the messages.

**ICMPv6 Messages With Errors Received** - The number of ICMP messages which the interface received but determined as having ICMP-specific errors (bad ICMP checksums, bad length, etc.)

**ICMPv6 Destination Unreachable Messages Received** - The number of ICMP Destination Unreachable messages received by the interface.

**ICMPv6 Messages Prohibited Administratively Received** - The number of ICMP destination unreachable/communication administratively prohibited messages received by the interface.

**ICMPv6 Time Exceeded Messages Received** - The number of ICMP Time Exceeded messages received by the interface.

**ICMPv6 Parameter Problem Messages Received** - The number of ICMP Parameter Problem messages received by the interface.

**ICMPv6 Packet Too Big Messages Received** - The number of ICMP Packet Too Big messages received by the interface.

**ICMPv6 Echo Request Messages Received** - The number of ICMP Echo (request) messages received by the interface.

**ICMPv6 Echo Reply Messages Received** - The number of ICMP Echo Reply messages received by the interface.

**ICMPv6 Router Solicit Messages Received** - The number of ICMP Router Solicit messages received by the interface.

**ICMPv6 Router Advertisement Messages Received** - The number of ICMP Router Advertisement messages received by the interface.

**ICMPv6 Neighbor Solicit Messages Received** - The number of ICMP Neighbor Solicit messages received by the interface.

**ICMPv6 Neighbor Advertisement Messages Received** - The number of ICMP Neighbor Advertisement messages received by the interface.

**ICMPv6 Redirect Messages Received** - The number of ICMPv6 Redirect messages received by the interface.

**ICMPv6 Group Membership Query Messages Received** - The number of ICMPv6 Group Membership Query messages received by the interface.

**ICMPv6 Group Membership Response Messages Received** - The number of ICMPv6 Group Membership Response messages received by the interface.

**ICMPv6 Group Membership Reduction Messages Received** - The number of ICMPv6 Group Membership Reduction messages received by the interface.

**Total ICMPv6 Messages Transmitted** - The total number of ICMP messages which this interface attempted to send. Note that this counter includes all those counted by icmpOutErrors.

**ICMPv6 Messages Not Transmitted Due To Error** - The number of ICMP messages which this interface did not send due to problems discovered within ICMP such as a lack of buffers. This value should not include errors discovered outside the ICMP layer such as the inability of IPv6 to route the resultant datagram. In some implementations there may be no types of error which contribute to this counter's value.

**ICMPv6 Destination Unreachable Messages Transmitted** - The number of ICMP Destination Unreachable Messages sent by the interface.

**ICMPv6 Messages Prohibited Administratively Transmitted** - Number of ICMP destination unreachable/communication administratively prohibited messages sent.

**ICMPv6 Time Exceeded Messages Transmitted** - The number of ICMP Time Exceeded messages sent by the interface.

**ICMPv6 Parameter Problem Messages Transmitted** - The number of ICMP Parameter Problem messages sent by the interface.

**ICMPv6 Packet Too Big Messages Transmitted** - The number of ICMP Packet Too Big messages sent by the interface.

**ICMPv6 Echo Request Messages Transmitted** - The number of ICMP Echo (request) messages sent by the interface.

**ICMPv6 Echo Reply Messages Transmitted** - The number of ICMP Echo Reply messages sent by the interface.

**ICMPv6 Router Solicit Messages Transmitted** - The number of ICMP Neighbor Solicitation messages sent by the interface.

**ICMPv6 Router Advertisement Messages Transmitted** - The number of ICMP Router Advertisement messages sent by the interface.

**ICMPv6 Neighbor Solicit Messages Transmitted** - The number of ICMP Neighbor Solicitation messages sent by the interface.

**ICMPv6 Neighbor Advertisement Messages Transmitted** - The number of ICMP Neighbor Advertisement messages sent by the interface.

**ICMPv6 Redirect Messages Transmitted** - The number of Redirect messages sent.

**ICMPv6 Group Membership Query Messages Transmitted** - The number of ICMPv6 Group Membership Query messages sent.

**ICMPv6 Group Membership Response Messages Transmitted** - The number of ICMPv6 Group Membership Response messages sent.

**ICMPv6 Group Membership Reduction Messages Transmitted** - The number of ICMPv6 Group Membership Reduction messages sent.

**ICMPv6 Duplicate Address Detects** - The number of duplicate Addresses detected by the interface.

### Command Buttons

**Refresh** - Refreshes the screen with most recent data.

**IPv6 Statistics** Print Reload Help

Slot/Port:

IPv6 Statistics	
Total Datagrams Received	0
Received Datagrams Locally Delivered	0
Received Datagrams Discarded Due To Header Errors	0
Received Datagrams Discarded Due To MTU	0
Received Datagrams Discarded Due To No Route	0
Received Datagrams With Unknown Protocol	0
Received Datagrams Discarded Due To Invalid Address	0
Received Datagrams Discarded Due To Truncated Data	0
Received Datagrams Discarded Other	0
Received Datagrams Reassembly Required	0
Datagrams Successfully Reassembled	0
Datagrams Failed To Reassemble	0
Datagrams Forwarded	0
Datagrams Locally Transmitted	0
Datagrams Transmit Failed	0
Datagrams Successfully Fragmented	0
Datagrams Failed To Fragment	0
Datagrams Fragments Created	0
Multicast Datagrams Received	0
Multicast Datagrams Transmitted	0

ICMPv6 Statistics	
Total ICMPv6 Messages Received	0
ICMPv6 Messages With Errors Received	0
ICMPv6 Destination Unreachable Messages Received	0
ICMPv6 Messages Prohibited Administratively Received	0
ICMPv6 Time Exceeded Messages Received	0
ICMPv6 Parameter Problem Messages Received	0
ICMPv6 Packet Too Big Messages Received	0
ICMPv6 Echo Request Messages Received	0
ICMPv6 Echo Reply Messages Received	0
ICMPv6 Router Solicit Messages Received	0
ICMPv6 Router Advertisement Messages Received	0
ICMPv6 Neighbor Solicit Messages Received	0
ICMPv6 Neighbor Advertisement Messages Received	0
ICMPv6 Redirect Messages Received	0
ICMPv6 Group Membership Query Messages Received	0
ICMPv6 Group Membership Response Messages Received	0
ICMPv6 Group Membership Reduction Messages Received	0
Total ICMPv6 Messages Transmitted	0
ICMPv6 Messages Not Transmitted Due To Error	0
ICMPv6 Destination Unreachable Messages Transmitted	0
ICMPv6 Messages Prohibited Administratively Transmitted	0
ICMPv6 Time Exceeded Messages Transmitted	0
ICMPv6 Parameter Problem Messages Transmitted	0
ICMPv6 Packet Too Big Messages Transmitted	0
ICMPv6 Echo Request Messages Transmitted	0
ICMPv6 Echo Reply Messages Transmitted	0
ICMPv6 Router Solicit Messages Transmitted	0
ICMPv6 Router Advertisement Messages Transmitted	0
ICMPv6 Neighbor Solicit Messages Transmitted	0
ICMPv6 Neighbor Advertisement Messages Transmitted	0
ICMPv6 Redirect Messages Transmitted	0
ICMPv6 Group Membership Query Messages Transmitted	0
ICMPv6 Group Membership Response Messages Transmitted	0
ICMPv6 Group Membership Reduction Messages Transmitted	0
ICMPv6 Duplicate Address Detects	0

### 11.2.5.5 Viewing IPv6 Neighbor Table Information Page

#### Selection Criteria

**Slot/Port** - Selects the interface whose information has to be displayed.

**Non-Configurable Data**

**Interface** - Specifies the interface whose settings are displayed in the current table row.

**IPv6 Address** - Specifies the IPv6 address of neighbor or interface.

**MAC Address** - Specifies MAC address associated with an interface.

**IsRtr** - Specifies router flag.

**Neighbor State** - Specifies the state of the neighbor cache entry. Following are the states for dynamic entries in the IPv6 neighbor discovery cache:

- **Incmp** - Address resolution is being performed on the entry. A neighbor solicitation message has been sent to the solicited-node multicast address of the target, but the corresponding neighbor advertisement message has not yet been received.
- **Reach** - Positive confirmation was received within the last Reachable Time milliseconds that the forward path to the neighbor was functioning properly. While in REACH state, the device takes no special action as packets are sent.
- **Stale** - More than ReachableTime milliseconds have elapsed since the last positive confirmation was received that the forward path was functioning properly. While in STALE state, the device takes no action until a packet is sent.
- **Delay** - More than ReachableTime milliseconds have elapsed since the last positive confirmation was received that the forward path was functioning properly. A packet was sent within the last DELAY\_FIRST\_PROBE\_TIME seconds. If no reachability confirmation is received within DELAY\_FIRST\_PROBE\_TIME seconds of entering the DELAY state, send a neighbor solicitation message and change the state to PROBE.
- **Probe** - A reachability confirmation is actively sought by resending neighbor solicitation messages every RetransTimer milliseconds until a reachability confirmation is received.

**Last Updated** - Time since the address was confirmed to be reachable.

**Command Buttons**

**Refresh** - Refreshes the screen with most recent data.

**Clear IPv6 Neighbors** - Clear IPv6 neighbors on selected interface or all interfaces.

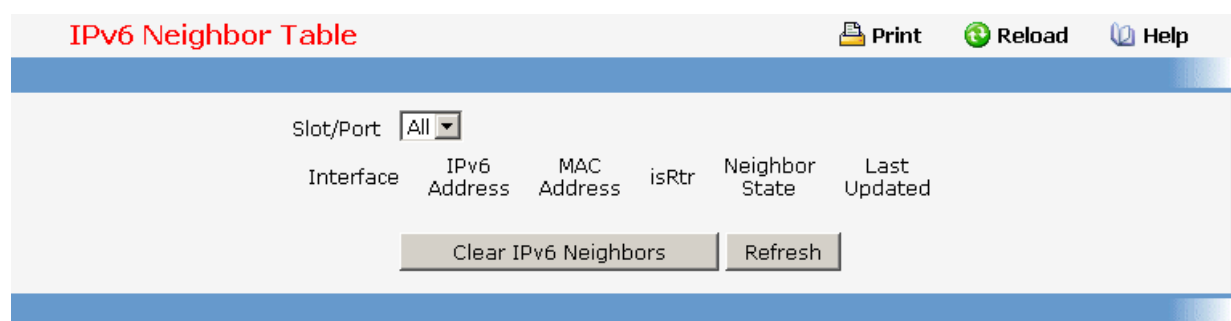

**IPv6 Neighbor Table** Print Reload Help

Slot/Port:

Interface	IPv6 Address	MAC Address	isRtr	Neighbor State	Last Updated
<input type="button" value="Clear IPv6 Neighbors"/> <input type="button" value="Refresh"/>					

### 11.2.5.6 Viewing IPv6 Static Neighbor Table Information Page

#### Configurable Data

**IPv6 Address** - Specifies the IPv6 address of neighbor.

**MAC Address** - Specifies the IPv6 address of neighbor.

#### Non-Configurable Data

**IPv6 Address** - Display the IPv6 address of current IPv6 neighbor table.

**MAC Address** - Display the MAC address of current IPv6 neighbor table.

#### Command Buttons

**Add** - Add the IPv6 neighbor.

**Delete** - Delete the IPv6 neighbor.

**Refresh** - Refreshes the screen with most recent data.

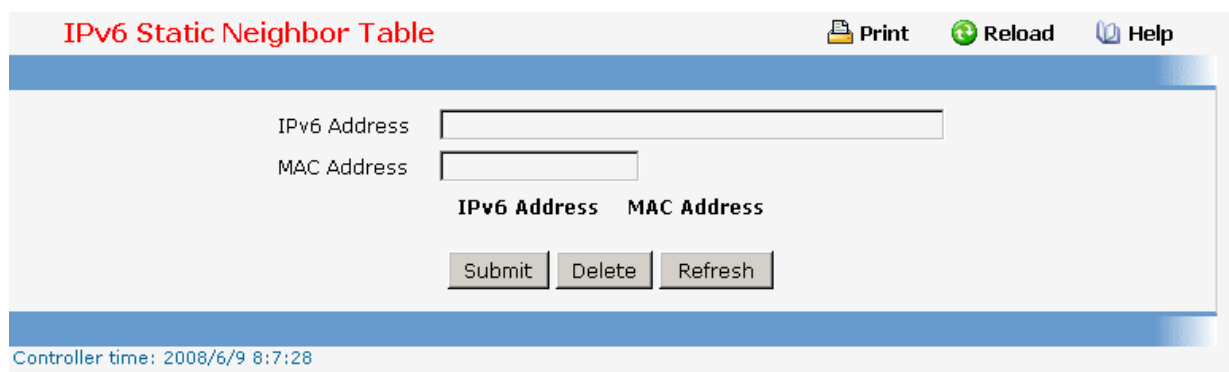

### 11.2.5.7 Managing DHCPv6 Protocol

#### 11.2.5.7.1. Configuring DHCPv6 Global Configuration Page

##### Configurable Data

**DHCPv6 Mode** - Specifies DHCPv6 operation on the switch. Value is enabled or disabled.

**Relay option** - Specifies Relay Agent Information Option value. The values allowed are between 32 to 65535. The default value is 32.

**Remote-id Sub-option**- Specifies the Relay Agent Information Option Remote-ID Sub-option type value. The values allowed are between 1 and 65535. The default value is 1.



## Command Buttons

**Submit** - Applies the new configuration and causes the changes to take effect. These changes will not be retained across a power cycle unless a save configuration is performed.

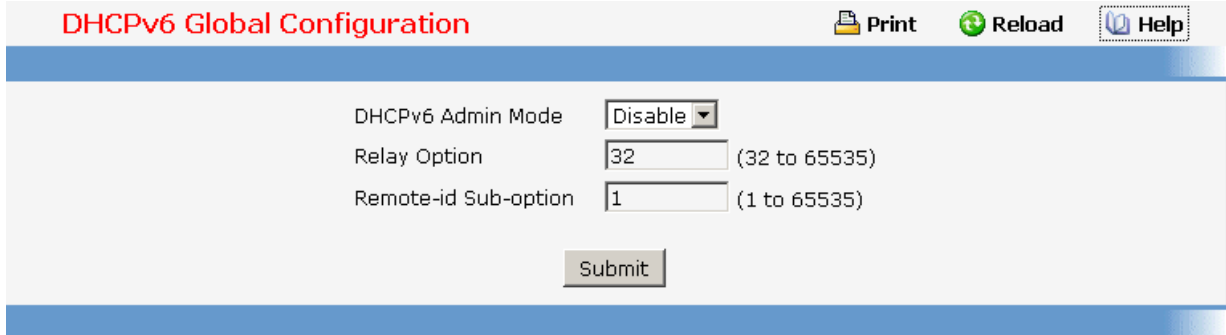

The screenshot shows the 'DHCPv6 Global Configuration' page. At the top right, there are three icons: 'Print', 'Reload', and 'Help'. The main configuration area contains three fields: 'DHCPv6 Admin Mode' with a dropdown menu set to 'Disable', 'Relay Option' with a text input '32' and a range '(32 to 65535)', and 'Remote-id Sub-option' with a text input '1' and a range '(1 to 65535)'. A 'Submit' button is located below these fields.

### 11.2.5.7.2. Configuring DHCPv6 Pool Configuration Page

#### Selector Type

**Pool Name** - Specifies all the pool names configured. It may be upto 31 alphanumeric characters.

**Domain Name** - Specifies list of domain name configured within a particular DHCPv6 pool. It may be upto 255 alphanumeric characters.

**Server Address** - Specifies list of IPv6 address of a DNS server within a particular DHCPv6 pool.

#### Configurable Data

**Pool Name** - Specifies unique name for DHCPv6 pool. It may be upto 31 alphanumeric characters.

**Domain Name** - Specifies DNS domain name. It may be upto 255 alphanumeric characters.

**Server Address** - Specifies the IPv6 address of a DNS server.

#### Command Buttons

**Submit** - Applies the new configuration and causes the changes to take effect. These changes will not be retained across a power cycle unless a save configuration is performed.

**Delete Pool** - Deletes the pool whose name is selected in the pool name list.

**Delete Server** - Deletes DNS Server from selected pool name list.

**Delete Domain** - Deletes DNS Domain name from selected pool name list.

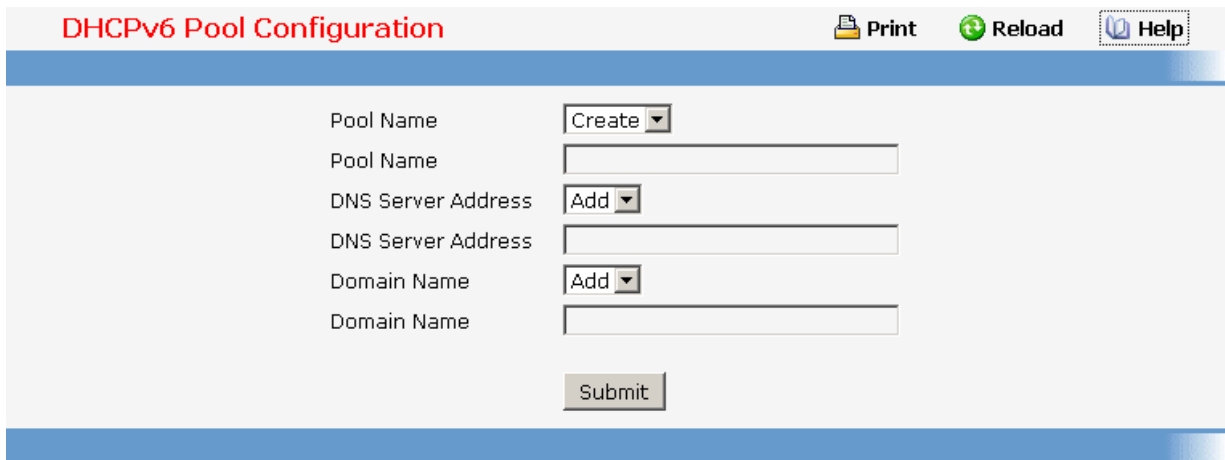

### 11.2.5.7.3. Configuring Prefix Delegation Configuration Page Selector Type

**Pool Name** - Specifies all the pool names configured.

**Delegated Prefix** - Specifies the delegated IPv6 prefix.

**DUID List** - Identifier used to identify the client's unique duid value.

#### Configurable Data

**Delegated Prefix** - Specifies the delegated IPv6 prefix.

**DUID** - Identifier used to identify the client's unique duid value.

**Valid Lifetime** - Specifies the valid lifetime in seconds for delegated prefix.



**Prefer Lifetime** - Specifies the prefer lifetime in seconds for delegated prefix.

#### Command Buttons

**Submit** - Applies the new configuration and causes the changes to take effect. These changes will not be retained across a power cycle unless a save configuration is performed.

**Delete Host** - Deletes Host IP address from selected pool name list.

Prefix Delegation Configuration

 **Print**
 **Reload**
 **Help**

---

Pool Name	<input type="text" value="hello"/>
Delegated Prefix	<input type="text" value="Add"/>
Delegated Prefix	<input type="text"/>
DUID List	<input type="text" value="Add"/>
DUID	<input type="text"/>
Valid Lifetime	<input type="text"/> (0 to 4294967295)
Prefer Lifetime	<input type="text"/> (0 to 4294967295)

#### 11.2.5.7.4. Viewing DHCPv6 Pool Summary Page

##### Selection Criteria

**Pool Name** - Specifies unique pool name configured.

##### Non-Configurable Data

**DNS Server** - Specifies the IPv6 address of a DNS server.

**Domain Name** - Specifies DNS domain name.

**DUID** - Identifier used to identify the client's unique duid value.

**Host IP Address** - Specifies the IPv6 address and mask length for delegated prefix.



**Valid Lifetime** - Specifies the valid lifetime in seconds for delegated prefix.

**Prefer Lifetime** - Specifies the preferred lifetime in seconds for delegated prefix.

##### Command Buttons

**Refresh** - Refreshes the screen with most recent data.

DHCPv6 Pool Summary

 **Print**
 **Reload**
 **Help**

---

Pool Name hello ▾

DNS Server

Domain Name hello-1

**Host IP Address    DUID    Valid Lifetime    Prefer Lifetime**

### 11.2.5.7.5. Configuring DHCPv6 Interface Configuration Page

#### Configurable Data

**Interface** - Specifies interface configured for DHCPv6 server functionality.

**Interface Mode** - Specifies DHCPv6 mode to configure either server or relay functionality. DHCPv6 server and DHCPv6 relay functions are mutually exclusive

**Pool Name** - Specifies the DHCPv6 pool containing stateless and/or prefix delegation parameters.

**Rapid Commit** - Rapid commit is an optional parameter. Specified to allow abbreviated exchange between the client and server.

**Preference** - Specifies the preference value used by clients to determine preference between multiple DHCPv6 servers. The values allowed are between 0 to 4294967295

**Destination IP Address** - Specifies an IPv6 address of a DHCPv6 relay server.

**Relay Interface** - Specifies an interface to reach a relay server.



**Remote ID** - Specifies the relay agent information option. Remote ID need to be derived from the DHCPv6 server DUID and the relay interface number, or it can be specified as a user defined string.

#### Command Buttons

**Submit** - Applies the new configuration and causes the changes to take effect. These changes will not be retained across a power cycle unless a save configuration is performed.

**Delete** - Deletes DHCPv6 configuration on selected interface.

DHCPv6 Interface Configuration

 Print
  Reload
  Help

---

Interface

Interface Mode

Pool Name

Rapid Commit

Preference  (0 to 4294967295)

### 11.2.5.7.6. Viewing DHCPv6 Server Bindings Summary Page

#### Non-Configurable Data

**Client Address** - Specifies the IPv6 address of the client associated with the binding.

**Client Interface** - Specifies the interface number where the client binding occurred.

**Client DUID** - Specifies client's DHCPv6 unique identifier.

**Prefix** - Specifies the type of prefix associated with this binding.

**Expiry Time** - Specifies the number of seconds until the prefix associated with a binding will expire.

**Valid Lifetime** - Specifies the valid lifetime value in seconds of the prefix associated with a binding.

**Prefer Lifetime** - Specifies the preferred lifetime value in seconds of the prefix associated with a binding.

#### Command Buttons

**Refresh** - Refreshes the screen with most recent data.

DHCPv6 Server Bindings Summary

 Print
  Reload
  Help

---

Client Address	Client Interface	Client DUID	Prefix	Expiry Time	Valid Lifetime	Prefer Lifetime
----------------	------------------	-------------	--------	-------------	----------------	-----------------

### 11.2.5.7.7. Viewing DHCPv6 Statistics Information Page

#### Selection Criteria

**Slot/Port** - Select the interface for which data is to be displayed or configured. On selecting global, data will be shown for all interfaces.

#### Non-Configurable Data

**Messages Received** - Specifies the aggregate of all interface level statistics for received messages.

**DHCPv6 Solicit Packets Received** -Specifies the number of Solicits.

**DHCPv6 Request Packets Received** -Specifies the number of Requests.

**DHCPv6 Confirm Packets Received** -Specifies the number of Confirms.

**DHCPv6 Renew Packets Received** -Specifies the number of Renews.

**DHCPv6 Rebind Packets Received** -Specifies the number of Rebinds.

**DHCPv6 Release Packets Received** -Specifies the number of Releases.

**DHCPv6 Decline Packets Received** -Specifies the number of Declines.

**DHCPv6 Inform Packets Received** -Specifies the number of Informs.

**DHCPv6 Relay-forward Packets Received** -Specifies the number of Relay forwards.

**DHCPv6 Relay-reply Packets Received** -Specifies the number of Relay Replies.

**DHCPv6 Malformed Packets Received** -Specifies the number of Malformed Packets.

**Received DHCPv6 Packets Discarded** -Specifies the number of Packets Discarded.

**Total DHCPv6 Packets Received** -Specifies the total number of Packets Received.

**Messages Sent** - Specifies the aggregate of all interface level statistics for messages sent.

**DHCPv6 Advertisement Packets Transmitted** -Specifies the number of Advertisements.

**DHCPv6 Reply Packets Transmitted** -Specifies the number of Replies.

**DHCPv6 Reconfig Packets Transmitted** -Specifies the number of Reconfigurations.

**DHCPv6 Relay-forward Packets Transmitted** -Specifies the number of Relay forwards.

**DHCPv6 Relay-reply Packets Transmitted** -Specifies the number of Relay Replies.

**Total DHCPv6 Packets Sent** -Specifies the total number of Packets Transmitted.

### Command Buttons

**Refresh** - Refreshes the screen with most recent data.

**Clear** - Clears the screen

DHCPv6 Statistics

 **Print**
 **Reload**
 **Help**

Slot/Port	Global ▾
<b>Messages Received:</b>	
DHCPv6 Solicit Packets Received	0
DHCPv6 Request Packets Received	0
DHCPv6 Confirm Packets Received	0
DHCPv6 Renew Packets Received	0
DHCPv6 Rebind Packets Received	0
DHCPv6 Release Packets Received	0
DHCPv6 Decline Packets Received	0
DHCPv6 Inform Packets Received	0
DHCPv6 Relay-forward Packets Received	0
DHCPv6 Relay-reply Packets Received	0
DHCPv6 Malformed Packets Received	0
Received DHCPv6 Packets Discarded	0
<b>Total DHCPv6 Packets Received</b>	<b>0</b>
<b>Messages Sent:</b>	
DHCPv6 Advertisement Packets Transmitted	0
DHCPv6 Reply Packets Transmitted	0
DHCPv6 Reconfig Packets Transmitted	0
DHCPv6 Relay-forward Packets Transmitted	0
DHCPv6 Relay-reply Packets Transmitted	0
<b>Total DHCPv6 Packets Sent</b>	<b>0</b>

Refresh
Clear

## 11.2.5.8 Managing OSPFv3 Protocol

### 11.2.5.8.1. Configuring OSPFv3 Configuration Page

#### Configurable Data

**Router ID** - The 32 bit integer in dotted decimal format that uniquely identifies the router within the autonomous system (AS). If you want to change the Router ID you must first disable OSPFv3. After you set the new Router ID, you must re-enable OSPFv3 to have the change take effect. The default value is 0.0.0.0, although this is not a valid Router ID.

**OSPFv3 Admin Mode\*** - Select enable or disable from the pull down menu. If you select enable OSPFv3 will be activated for the switch. The default value is enable. You must configure a Router ID before OSPFv3 can become operational. This can also be done by issuing the CLI command router-id, in the ipv6 router ospf mode.

**\*NOTE: once OSPFv3 is initialized on the router, it will remain initialized until the router is reset.**

**Exit Overflow Interval** - Enter the number of seconds that, after entering overflow state, the router should wait before attempting to leave overflow state. This allows the router to again originate non-default AS-external-LSAs. If you enter 0, the router will not leave Overflow State until restarted. The range is 0 to 2147483647 seconds.

**External LSDB Limit** - The maximum number of AS-External-LSAs that can be stored in the database. A value of -1 implies there is no limit on the number that can be saved. The valid range of values is (-1 to 2147483647).

**Default Metric** - Sets a default for the metric of redistributed routes. This field displays the default metric if one has already been set or blank if not configured earlier. The valid values are (1 to 16777214)

**Maximum Paths** - Configure the maximum number of paths that OSPFv3 can report to a given destination. The valid values are (1 to 2)

### **Default Route Advertise**

**Default Information Originate** - Enable or Disable Default Route Advertise. Note that the values for 'Always', 'Metric' and 'Metric Type' can only be configured after Default Information Originate is set to enable. If Default Information Originate is set to enable and values for 'Always', 'Metric' and 'Metric Type' are already configured, then setting Default Information Originate back to disable will set the 'Always', 'Metric' and 'Metric Type' values to default.

**Always** - Sets the router advertise ::/0 when set to "True".

**Metric** - Specifies the metric of the default route. The valid values are (0 to 16777214)

**Metric Type** - Sets the metric type of the default route. Valid values are External Type 1 and External Type 2.

### **Non-Configurable Data**

**ASBR Mode** - Reflects whether the ASBR mode is enabled or disabled. Enable implies that the router is an autonomous system border router. Router automatically becomes an ASBR when it is configured to redistribute routes learnt from other protocol.

**ABR Status** - The values of this are enabled or disabled. Enabled implies that the router is an area border router. Disabled implies that it is not an area border router.

**External LSA Count** - The number of external (LS type 5) LSAs (link state advertisements) in the link state database.



**External LSA Checksum** - The sum of the LS checksums of the external LSAs (link state advertisements) contained in the link-state database. This sum can be used to determine if there has been a change in a router's link state database, and to compare the link-state databases of two routers.



**New LSAs Originated** - In any given OSPFv3 area, a router will originate several LSAs. Each router originates a router-LSA. If the router is also the Designated Router for any of the area's networks, it will originate network-LSAs for those networks. This value represents the number of LSAs originated by this router.

**LSAs Received** - The number of LSAs (link state advertisements) received that were determined to be new instantiations. This number does not include newer instantiations of self-originated LSAs.

### Command Buttons

**Submit** - Send the updated configuration to the switch. Configuration changes take effect immediately. These changes will not be retained across a power cycle unless a save is performed.

OSPFv3 Configuration

 Print
  Reload
  Help

Router ID	<input type="text" value="0.0.0.0"/>	
OSPFv3 Admin Mode	<input type="button" value="Enable"/>	
ASBR Mode	Disabled	
ABR Status		
Exit Overflow Interval (secs)	<input type="text" value="0"/>	(0 to 2147483647)
External LSA Count		
External LSA Checksum		
New LSAs Originated		
LSAs Received		
External LSDB Limit	<input type="button" value="No Limit"/>	(-1(No Limit) to 2147483647)
Default Metric	<input type="text"/>	(1 to 16777214)
Maximum Paths	<input type="text" value="2"/>	(1 to 2)
Default Route Advertise		
Default Information Originate	<input type="button" value="Disable"/>	
Always	<input type="button" value="False"/>	
Metric	<input type="text"/>	(0 to 16777214)
Metric Type	<input type="button" value="External Type 2"/>	
<input type="button" value="Submit"/>		

### 11.2.5.8.2. Configuring OSPFv3 Area Configuration Page

#### Selection Criteria

**Area ID** - Select the area to be configured.

### Configurable Data

**Import Summary LSAs** - Select enable or disable from the pulldown menu. If you select enable summary LSAs will be imported into areas. Defaults to Enable.

#### Stub Area Specific Parameters.

**Metric Value** - Enter the metric value you want applied for the default route advertised into the stub area. Valid values range from 1 to 16,777,215. This value is applicable only to Stub areas.

#### NSSA Specific Parameters.

**Default Information Originate** - The default Route Information. This can also be applied by the CLI command 'area (area-id) nssa default-info-originate' in the ipv6 router ospf config mode. Valid values are True or False.

**Default Metric** - Set the Default Metric value for NSSA. The valid range of values is (1 to 16777214).

**Metric Type** - Select the type of metric specified in the Metric Value field.

- **Default** - The default metric value. On CLI this value shows up as "-----"
- **Comparable Cost** - External Type 1 metrics that are comparable to the OSPFv3 metric
- **Non-comparable Cost** - External Type 2 metrics that are assumed to be larger than the cost of the OSPFv3 metric

**Translator Role** - NSSA Border router's ability to perform NSSA translation of type-7 LSAs into type-5 LSAs. The valid values are 'Always' and 'Candidate'.

**Translator Stability Interval** - The number of seconds after an elected translator determines its services are no longer required, that it should continue to perform its translation duties. The valid range of values is (0 to 3600).

**No-Redistribute Mode** - Enable or Disable the No-Redistribute Mode.

### Non-Configurable Data

**Area ID** - The OSPFv3 area. An Area ID is a 32 bit integer in dotted decimal format that uniquely identifies the area to which a router interface connects.

**External Routing** - A definition of the router's capabilities for the area, including whether or not AS-external-LSAs are flooded into/throughout the area.

**SPF Runs** - The number of times that the intra-area route table has been calculated using this area's link-state database. This is done using Dijkstra's algorithm.

**Area Border Router Count** - The total number of area border routers reachable within this area. This is initially zero, and is calculated in each SPF Pass.

**Area LSA Count** - The total number of link-state advertisements in this area's link-state database, excluding AS External LSAs.

**Area LSA Checksum** - The 32-bit unsigned sum of the link-state advertisements' LS checksums contained in this area's link-state database. This sum excludes external (LS type 5) link-state advertisements. The sum can be used to determine if there has been a change in a router's link state database, and to compare the link-state database of two routers.

#### **Stub Area Specific Parameters.**

**Metric Value** - The Configured Metric value for the Stub. This can be modified using the CLI command 'area (area-id) default-cost' in the ipv6 router ospf config mode. The valid range is (1 to 16777215).

#### **NSSA Specific Parameters.**

**Translator State** - Translator State 'Enabled' means that the NSSA router OSPFv3 Area Nssa Translator Role has been set to always. Translator State of 'Elected' means a candidate NSSA Border router is translating type-7 LSAs into type-5.' Disabled' implies that a candidate NSSA Border router is NOT translating type-7 LSAs into type-5.

### **Command Buttons**

**Create Stub Area** - Configure the area as a stub area.

**Delete Stub Area** - Delete the stub area designation. The area will be returned to normal state.

**Create NSSA** - Configure the area as NSSA.

**Delete NSSA** - Delete the NSSA designation. The area will be returned to normal state.

**Submit** - Send the updated configuration to the switch. Configuration changes take effect immediately. These changes will not be retained across a power cycle unless a save is performed.

**OSPFv3 Area Configuration** Print Reload Help

Area ID	0.0.0.3
External Routing	Import No LSAs
SPF Runs	8
Area Border Router Count	0
Area LSA Count	6
Area LSA Checksum	154419

### 11.2.5.8.3. Viewing OSPFv3 Stub Area Summary Page

#### Non-Configurable Data

**Area ID** - The Area ID of the Stub area

**Metric Value** - The metric value applied to the default route advertised into the area.

**Import Summary LSAs** - Whether the import of Summary LSAs is enabled or disabled.

#### Command Buttons

**Refresh** - Refresh the data on the screen to the current values from the switch.

**OSPFv3 Stub Area Summary** Print Reload Help

Area ID	Metric Value	Import Summary LSAs
0.0.0.3	1	Enable

### 11.2.5.8.4. Configuring OSPFv3 Area Range Configuration Page

#### Selection Criteria

**Area ID** - Selects the area for which data is to be configured.

#### Configurable Data

**IPv6 Prefix** - Enter the IPv6 Prefix/Prefix Length for the address range for the selected area.

**LSDB Type** - Select the type of Link Advertisement associated with the specified area and address range. The default type is 'Network Summary'.

**Advertisement** - Select enable or disable from the pulldown menu. If you selected enable the address range will be advertised outside the area via a Network Summary LSA. The default is enable.

### Non-Configurable Data

**Area ID** - The OSPFv3 area.

**IPv6 Prefix** - The IPv6 Prefix of an address range for the area.

**LSDB Type** - The Link Advertisement type for the address range and area.

**Advertisement** - The Advertisement mode for the address range and area.

### Command Buttons

**Create New Area Range** - Send the updated configuration to the switch. Configuration changes take effect immediately. These changes will not be retained across a power cycle unless a save is performed. The new address range will be added to the display in the non-configurable data area.

**Delete** - Removes the specified address range from the area configuration.

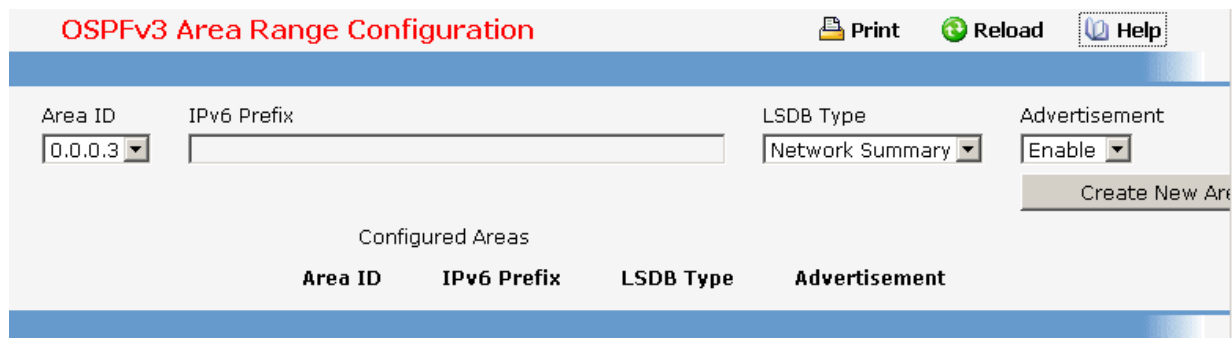

#### 11.2.5.8.5. Configuring OSPFv3 Interface Configuration Page

##### Selection Criteria

**Slot/Port** - Select the interface for which data is to be displayed or configured.

##### Configurable Data

**OSPFv3 Admin Mode\*** - You may select enable or disable from the pulldown menu. The default value is 'disable.' You can configure OSPFv3 parameters without enabling OSPFv3 Admin Mode, but they will have no effect until you enable Admin Mode. The following information will be displayed only if the Admin Mode is enabled: State, Designated Router,

Backup Designated Router, Number of Link Events, LSA Ack Interval, and Metric Cost. For OSPFv3 to be fully functional, the interface must have a valid IPv6 Prefix/Prefix Length. This can be done through the CLI using the ipv6 address command in the interface configuration mode. .

**\*NOTE: once OSPFv3 is initialized on the router, it will remain initialized until the router is reset.**

**OSPFv3 Area ID** - Enter the 32 bit integer in dotted decimal format that uniquely identifies the OSPFv3 area to which the selected router interface connects. If you assign an Area ID which does not exist, the area will be created with default values.

**Router Priority** - Enter the OSPFv3 priority for the selected interface. The priority of an interface is specified as an integer from 0 to 255. The default is 1, which is the highest router priority. A value of '0' indicates that the router is not eligible to become the designated router on this network

**Retransmit Interval** - Enter the OSPFv3 retransmit interval for the specified interface. This is the number of seconds between link-state advertisements for adjacencies belonging to this router interface. This value is also used when retransmitting database descriptions and link-state request packets. Valid values range from 0 to 3600 seconds (1 hour). The default is 5 seconds.

**Hello Interval** - Enter the OSPFv3 hello interval for the specified interface in seconds. This parameter must be the same for all routers attached to a network. Valid values range from 1 to 65,535. The default is 10 seconds.

**Dead Interval** - Enter the OSPFv3 dead interval for the specified interface in seconds. This specifies how long a router will wait to see a neighbor router's Hello packets before declaring that the router is down. This parameter must be the same for all routers attached to a network. This value should be a multiple of the Hello Interval (e.g. 4). Valid values range from 1 to 2147483647. The default is 40.

**Iftransit Delay Interval** - Enter the OSPFv3 Transit Delay for the specified interface. This specifies the estimated number of seconds it takes to transmit a link state update packet over the selected interface. Valid values range from 1 to 3600 seconds (1 hour). The default value is 1 second.

**MTU Ignore** - Disables OSPFv3 MTU mismatch detection on receiving packets. Default value is Disable.

**Interface Type** - The interface type, which can either be set to broadcast mode or point to point mode. The default interface type is broadcast.

**Metric Cost** - Enter the value on this interface for the cost TOS (type of service). The range for the metric cost is between 1 and 65,535. Metric Cost is only configurable if OSPFv3 is initialized on the interface.

### Non-Configurable Data

**IPv6 Address** - The IPv6 address of the interface.

**LSA Ack Interval** - The number of seconds between LSA Acknowledgment packet transmissions, which must be less than the Retransmit Interval.

**State** - The current state of the selected router interface. One of:

- **Down** - This is the initial interface state. In this state, the lower-level protocols have indicated that the interface is unusable. In this state, interface parameters will be set to their initial values. All interface timers will be disabled, and there will be no adjacencies associated with the interface.
- **Loopback** - In this state, the router's interface to the network is looped back either in hardware or software. The interface is unavailable for regular data traffic. However, it may still be desirable to gain information on the quality of this interface, either through sending ICMP pings to the interface or through something like a bit error test. For this reason, IP packets may still be addressed to an interface in Loopback state. To facilitate this, such interfaces are advertised in router- LSAs as single host routes, whose destination is the IP interface address.
- **Waiting** - The router is trying to determine the identity of the (Backup) Designated Router for the network by monitoring received Hello Packets. The router is not allowed to elect a Backup Designated Router or a Designated Router until it transitions out of Waiting state. This prevents unnecessary changes of (Backup) Designated Router.
- **Designated Router** - This router is itself the Designated Router on the attached network. Adjacencies are established to all other routers attached to the network. The router must also originate a network-LSA for the network node. The network-LSA will contain links to all routers (including the Designated Router itself) attached to the network.
- **Backup Designated Router** - This router is itself the Backup Designated Router on the attached network. It will be promoted to Designated Router if the present Designated Router fails. The router establishes adjacencies to all other routers attached to the network. The Backup Designated Router performs slightly different functions during the Flooding Procedure, as compared to the Designated Router.
- **Other Designated Router** - The interface is connected to a broadcast or NBMA network on which other routers have been selected to be the Designated Router and Backup Designated Router either. The router attempts to form adjacencies to both the Designated Router and the Backup Designated Router.

The State is only displayed if the OSPFv3 admin mode is enabled.

**Designated Router** - The identity of the Designated Router for this network, in the view of the advertising router. The Designated Router is identified here by its router ID. The value 0.0.0.0 means that there is no Designated Router. This field is only displayed if the OSPFv3 admin mode is enabled.



**Backup Designated Router** - The identity of the Backup Designated Router for this network, in the view of the advertising router. The Backup Designated Router is identified here by its router ID. Set to 0.0.0.0 if there is no Backup Designated Router. This field is only displayed if the OSPFv3 admin mode is enabled.

**Number of Link Events** - This is the number of times the specified OSPFv3 interface has changed its state. This field is only displayed if the OSPFv3 admin mode is enabled.

## Command Buttons

**Submit** - Send the updated configuration to the switch. Configuration changes take effect immediately. These changes will not be retained across a power cycle unless a save is performed.

OSPFv3 Interface Configuration

 Print
  Reload
  Help

Slot/Port	<input type="text" value="0/1"/>
IPv6 Address	FE80::2C0:9FFF:FE11:229B
OSPFv3 Admin Mode	<input type="text" value="Enable"/>
OSPFv3 Area ID	<input type="text" value="0.0.0.3"/>
Router Priority	<input type="text" value="1"/> (0 to 255)
Retransmit Interval (secs)	<input type="text" value="5"/> (0 to 3600)
Hello Interval (secs)	<input type="text" value="10"/> (1 to 65535)
Dead Interval (secs)	<input type="text" value="40"/> (1 to 2147483647)
LSA Ack Interval (secs)	1
Iftransit Delay Interval (secs)	<input type="text" value="1"/> (1 to 3600)
MTU Ignore	<input type="text" value="Disable"/>
Interface Type	<input type="text" value="Broadcast"/>
State	Backup-Designated-Router
Designated Router	2.2.2.2
Backup Designated Router	0.0.0.1
Number of Link Events	8
Metric Cost	<input type="text" value="1"/> (1 to 65535)

### 11.2.5.8.6. Viewing OSPFv3 Interface Statistics Page

This screen displays statistics for the selected interface. The information will be displayed only if OSPFv3 is enabled.

#### Selection Criteria

**Slot/Port** - Select the interface for which data is to be displayed.

#### Non-Configurable Data

**OSPFv3 Area ID** - The OSPFv3 area to which the selected router interface belongs. An OSPFv3 Area ID is a 32 bit integer in dotted decimal format that uniquely identifies the area to which the interface connects.

**Area Border Router Count** - The total number of area border routers reachable within this area. This is initially zero, and is calculated in each SPF Pass.



**AS Border Router Count** - The total number of Autonomous System border routers reachable within this area. This is initially zero, and is calculated in each SPF Pass.

**Area LSA Count** - The total number of link-state advertisements in this area's link-state database, excluding AS External LSAs.

**IPv6 Address** - The IPv6 address of the interface.

**Interface Events** - The number of times the specified OSPFv3 interface has changed its state or an error has occurred.

**Virtual Events** - The number of state changes or errors that have occurred on this virtual link.



**Neighbor Events** - The number of times this neighbor relationship has changed state or an error has occurred.

**External LSA Count** - The number of external (LS type 5) link-state advertisements in the link-state database.

### Command Buttons

**Refresh** - Refresh the data on the screen with the present state of the data in the switch.

OSPFv3 Interface Statistics

 Print
 Reload
 Help

---

Slot/Port	0/1 ▾
OSPFv3 Area ID	0.0.0.3
Area Border Router Count	0
AS Border Router Count	0
Area LSA Count	6
IPv6 Address	FE80::2C0:9FFF:FE11:229B
Interface Events	8
Virtual Events	0
Neighbor Events	6
External LSA Count	0

#### 11.2.5.8.7. Viewing OSPFv3 Neighbor Information Page

This screen shows the OSPFv3 Neighbor information for a selected neighbor Router ID on the selected interface. When a particular Neighbor Router ID is selected, it shows detailed information about the neighbor. This information is displayed only if OSPFv3 is enabled and there is at least one OSPFv3 enabled interface with a valid neighbor present.

#### Selection Criteria

**Slot/Port** - Select the Interface for which the data needs to be displayed.

**Neighbor Router ID** - Selects a specific neighbor router ID on the interface selected in the Slot/Port selector.

### Non-Configurable Data

**Area ID** - A 32-bit integer in dotted decimal format representing the area common to the neighbor selected.

**Options** - A Bit Mask corresponding to the neighbor's options field.

**Priority** - The priority of this neighbor in the designated router election algorithm. A value of 0 signifies that the neighbor is not eligible to become the designated router on this particular network.

**Dead Timer Due in (secs)** - Number of seconds since last Hello was received from Adjacent Neighbors. Set to 0 for neighbors in a state less than or equal to Init.

**State** - State of the relationship with this neighbor.



**Events** - The number of times this neighbor relationship has changed state, or an error has occurred.

**Retransmission Queue Length** - Length of the selected neighbor's retransmit queue.

### Command Buttons

**Refresh** - Refreshes the page with the latest OSPFv3 neighbor information for the selected interface and Neighbor Router ID.

OSPFv3 Neighbors

 Print
  Reload
  Help

Slot/Port	0/1
Neighbor Router ID	2.2.2.2
Area ID	0.0.0.3
Options	0x11
Router Priority	1
Dead Timer Due in (secs)	39
State	Full/DR
Events	6
Retransmission Queue Length	0

### 11.2.5.8.8. Viewing OSPFv3 Neighbor Table Information Page

This screen shows the OSPFv3 Neighbor Table, either for all interfaces on which valid OSPFv3 Neighbors are present or the neighbors specific to a given interface on which OSPFv3 Neighbors exist. This information is displayed only if OSPFv3 is enabled and there exists at least on OSPFv3 enabled interface having a valid neighbor.

#### Selection Criteria

**Slot/Port** - Select the Interface for which the data needs to be displayed. Selecting 'All' will display all valid interfaces.

#### Non-Configurable Data

**Neighbor Router ID** - A 32-bit integer in dotted decimal format representing the Router ID of the neighbor on the selected Interface.

**Priority** - The priority of this neighbor in the designated router election algorithm. A value of 0 signifies that the neighbor is not eligible to become the designated router on this particular network.

**IntIf ID** - The interface ID that the neighbor advertises in its Hello packets on this link.

**Interface** - A Slot/Port identifying the neighbor interface index.

**State** - State of the relationship with this neighbor.

**Dead Time** - Number of seconds since last Hello was received from Adjacent Neighbors. Set to 0 for neighbors in a state less than or equal to Init.

#### Command Buttons

**Refresh** - Refreshes the page with the latest OSPFv3 neighbor information for the selected interface.

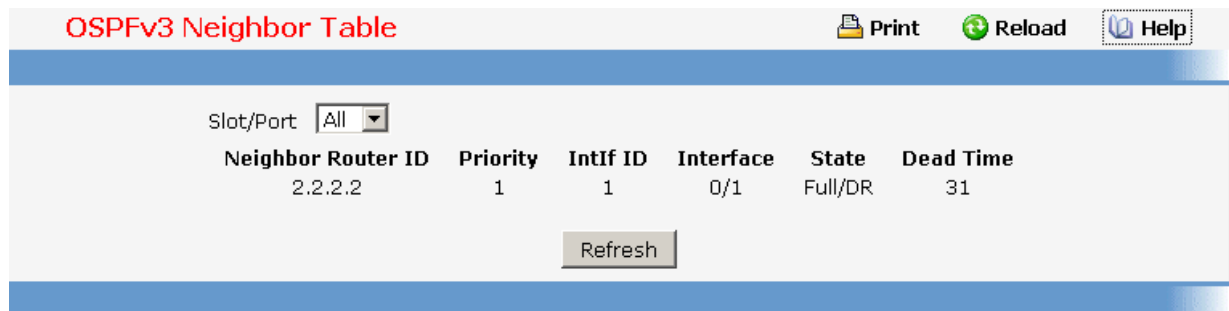

**OSPFv3 Neighbor Table** Print Reload Help

Slot/Port:

Neighbor Router ID	Priority	IntIf ID	Interface	State	Dead Time
2.2.2.2	1	1	0/1	Full/DR	31

### 11.2.5.8.9. Viewing OSPFv3 Link State Database Information Page

#### Non-Configurable Data

**Router ID** - The 32 bit integer in dotted decimal format that uniquely identifies the router within the autonomous system (AS). The Router ID is set on the OSPFv3 Interface Configuration page. If you want to change the Router ID you must first disable OSPFv3. After you set the new Router ID, you must re-enable OSPFv3 to have the change take effect. The default value is 0.0.0.0, although this is not a valid Router ID.

**Area ID** - The ID of an OSPFv3 area to which one of the router interfaces is connected. An Area ID is a 32 bit integer in dotted decimal format that uniquely identifies the area to which an interface is connected.

**LSA Type** - The format and function of the link state advertisement. One of the following:

- **Router Links**
- **Network Links**
- **Network Summary**
- **ASBR Summary**
- **AS-external**

**LS ID** - The Link State ID identifies the piece of the routing domain that is being described by the advertisement. The value of the LS ID depends on the advertisement's LS type.

**Age** - The time since the link state advertisement was first originated, in seconds.

**Sequence** - The sequence number field is a signed 32-bit integer. It is used to detect old and duplicate link state advertisements. The larger the sequence number, the more recent the advertisement.

**Checksum** - The checksum is used to detect data corruption of an advertisement. This corruption can occur while an advertisement is being flooded, or while it is being held in a router's memory. This field is the checksum of the complete contents of the advertisement, except the LS age field.

**Options** - The Options field in the link state advertisement header indicates which optional capabilities are associated with the advertisement.

**Rtr Options** - The router specific options.

## Command Buttons

**Refresh** - Refresh the data on the screen with the present state of the data in the switch.

OSPFv3 Link State Database									
							Print	Reload	Help
Adv. Router	Area ID	LSA Type	Link ID	Age	Sequence	Checksum	Options	Rtr Opt.	
0.0.0.1	0.0.0.3	Router Links	0	173	8000000A	0706	V6---R-	----	
2.2.2.2	0.0.0.3	Router Links	0	179	80000008	d433	V6---R-	----	
2.2.2.2	0.0.0.3	Network Links	1	184	80000002	2ee9	V6---R-		
0.0.0.1	0.0.0.3	Link	1	179	80000006	e032	V6---R-		
2.2.2.2	0.0.0.3	Link	1	184	80000006	435a	V6---R-		
0.0.0.1	0.0.0.3	Intra Prefix	0	174	80000008	f512			
2.2.2.2	0.0.0.3	Intra Prefix	0	179	80000009	1ae1			
2.2.2.2	0.0.0.3	Intra Prefix	10001	180	80000003	1ecc			
Refresh									

### 11.2.5.8.10. Configuring OSPFv3 Virtual Link Configuration Page

#### Selection Criteria

**Create New Virtual Link** - Select this option from the dropdown menu to define a new virtual link. The area portion of the virtual link identification is fixed: you will be prompted to enter the Neighbor Router ID on a new screen.

**Area ID and Neighbor Router ID** - Select the virtual link for which you want to display or configure data. It consists of the Area ID and Neighbor Router ID.

#### Configurable Data

**Hello Interval** - The OSPFv3 hello interval for the specified interface in seconds. This parameter must be the same for all routers attached to a network. Valid values range from 1 to 65,535. The default is 10 seconds.

**Dead Interval** - The OSPFv3 dead interval for the specified interface in seconds. This specifies how long a router will wait to see a neighbor router's Hello packets before declaring that the router is down. This parameter must be the same for all routers attached to a network. This value should be a multiple of the Hello Interval (e.g. 4). Valid values range from 1 to 2147483647. The default is 40.

**Iftransit Delay Interval** - The OSPFv3 Transit Delay for the specified interface. This specifies the estimated number of seconds it takes to transmit a link state update packet over the selected interface. Valid values range from 1 to 3600 seconds (1 hour). The default value is 1 second.

**Retransmit Interval** - The OSPFv3 retransmit interval for the specified interface. This is the number of seconds between link-state advertisements for adjacencies belonging to this router interface. This value is also used when retransmitting database descriptions and link-state request packets. Valid values range from 1 to 3600 seconds (1 hour). The default is 5 seconds.

## Non-Configurable Data

**State** - The state of the interface.

- **Down** - This is the initial interface state. In this state, the lower-level protocols have indicated that the interface is unusable. In this state, interface parameters will be set to their initial values. All interface timers will be disabled, and there will be no adjacencies associated with the interface.
- **Waiting** - The router is trying to determine the identity of the (Backup) Designated Router by monitoring received Hello Packets. The router is not allowed to elect a Backup Designated Router or a Designated Router until it transitions out of Waiting state. This prevents unnecessary changes of (Backup) Designated Router.
- **Point-to-Point** - The interface is operational, and is connected either to the virtual link. On entering this state the router attempts to form an adjacency with the neighboring router. Hello Packets are sent to the neighbor every HelloInterval seconds.
- **Designated Router** - This router is itself the Designated Router on the attached network. Adjacencies are established to all other routers attached to the network. The router must also originate a network-LSA for the network node. The network-LSA will contain links to all routers (including the Designated Router itself) attached to the network.
- **Backup Designated Router** - This router is itself the Backup Designated Router on the attached network. It will be promoted to Designated Router if the present Designated Router fails. The router establishes adjacencies to all other routers attached to the network. The Backup Designated Router performs slightly different functions during the Flooding Procedure, as compared to the Designated Router.
- **Other Designated Router** - The interface is connected to a broadcast or NBMA network on which other routers have been selected to be the Designated Router and Backup Designated Router either. The router attempts to form adjacencies to both the Designated Router and the Backup Designated Router.

**Neighbor State** - The state of the Virtual Neighbor Relationship.



**Metric** - The metric value used by the Virtual Link.

## Command Buttons

**Submit** - Send the updated configuration to the switch. Configuration changes take effect immediately. These changes will not be retained across a power cycle unless a save is performed.

**Delete** - Removes the specified virtual link from the router configuration.

OSPFv3 Virtual Link Configuration

 **Print**
 **Reload**
 **Help**

Virtual Link (Area ID - Neighbor Router ID) Create New Virtual Link ▾

Area ID 0.0.0.3 ▾

Neighbor Router ID

### 11.2.5.8.11. Viewing OSPFv3 Virtual Link Summary Page

#### Non-Configurable Data

**Area ID** - The Area ID portion of the virtual link identification for which data is to be displayed. The Area ID and Neighbor Router ID together define the virtual link.

**Neighbor Router ID** - The neighbor portion of the virtual link identification. Virtual links may be configured between any pair of area border routers having interfaces to a common (non-backbone) area.

**Hello Interval** - The OSPFv3 hello interval for the virtual link in units of seconds.

**Dead Interval** - The OSPFv3 dead interval for the virtual link in units of seconds. This determines how long a router will wait to see a neighbor router's Hello packets before declaring that the router is down.

**Retransmit Interval** - The OSPFv3 retransmit interval for the virtual link in units of seconds. This specifies the time between link-state advertisements for adjacencies belonging to this router interface. This value is also used when retransmitting database descriptions and link-state request packets.

**Iftransit Delay Interval** - The OSPFv3 Transit Delay for the virtual link in units of seconds. It specifies the estimated number of seconds it takes to transmit a link state update packet over this interface.

#### Command Buttons

**Refresh** - Refresh the data on the screen with the present state of the data in the switch.

OSPFv3 Virtual Link Summary					
Area ID	Neighbor Router ID	Hello Interval (secs)	Dead Interval (secs)	Retransmit Interval (secs)	Iftransit Delay Interval (secs)
<input type="button" value="Refresh"/>					

### 11.2.5.8.12. Configuring OSPFv3 Route Redistribution Configuration Page

This screen can be used to configure the OSPFv3 Route Redistribution parameters. The allowable range for each field is displayed next to it. If an invalid value is entered in one or multiple fields, an alert message will be displayed with the list of all the valid values.

#### Configurable Data

**Configured Source** - This dynamic select list is populated by only those Source Protocols that have already been configured for redistribution by OSPFv3. However, the topmost option in the select box is "Create", and this allows the user to configure another, among the Available Source Protocols. The valid values are 'Static' and 'Connected'. An additional 'Create' option is also available.

**Available Source** - This dynamic select list is populated by only those Source Protocols that have not previously been configured for redistribution by OSPFv3. This select box would appear only if the user selects "Create" option as Configured Source. The valid values are 'Static' or 'Connected'.

**Metric**- Sets the metric value to be used as the metric of redistributed routes. This field displays the metric if the source was pre-configured and can be modified. The valid values are (0 to 16777214)

**Metric Type** - Sets the OSPFv3 metric type of redistributed routes.

**Tag** - Sets the tag field in routes redistributed. This field displays the tag if the source was pre-configured, else a default tag value of 0 is displayed. The valid values are (0 to 4294967295)

#### Command Buttons

**Submit** - Send the updated configuration to the router. Configuration changes take effect immediately.

**Delete** - Delete the entry of the Source Protocol selected as Configured Source from the list of Sources configured for OSPFv3 Route Redistribution.



**OSPFv3 Route Redistribution Configuration** Print Reload Help

Configured Source

Available Source

Metric  (0 to 16777214)

Metric Type

Tag  (0 to 4294967295)

### 11.2.5.8.13. Viewing OSPFv3 Route Redistribution Summary Page

This screen displays the OSPFv3 Route Redistribution Configuration Summary.

#### Non Configurable Data

**Source** - The Source Protocol to be Redistributed by OSPFv3.

**Metric**- The Metric of redistributed routes for the given Source Protocol.

**Metric Type** - The OSPFv3 metric type of redistributed routes.

**Tag** - The tag field in routes redistributed.

#### Command Buttons

**Refresh** - Displays the latest OSPFv3 Route Redistribution Configuration data.

**OSPFv3 Route Redistribution Summary** Print Reload Help

Source	Metric	Metric Type	Tag
Static	Not Configure	External Type 2	0

## 11.2.5.9 Managing IPv6 Routes

### 11.2.5.9.1. Configuring IPv6 Route Entry Configuration Page

#### Selection Criteria

**Global or Link-local Next-hop** - Specify if the Next Hop IPv6 Address is a Global IPv6 Address or a Link-local IPv6 Address.

**Slot/Port** - Enter the unit, slot and port number for the Link-local IPv6 Next Hop Address. This field is displayed only if the Global or Link-local Next-hop Selector is selected as Link-local.

### Configurable Data

**IPv6 Network Prefix/PrefixLength** - Enter an IPv6 Network Address with Prefix Length.

**Next Hop IPv6 Address** - Enter an IPv6 Next Hop Address. If the Next Hop IPv6 Address specified is a Link-local IPv6 Address, specify the Slot/Port for the Link-local IPv6 Next Hop Address.

**Preference** - Enter a Preference Value for the given route.

### Command Buttons

**Submit** - Send the updated configuration to the switch. Configuration changes take effect immediately. These changes will not be retained across a power cycle unless a save is performed.

**Cancel** - Discards the changes made on the page and navigates back to the referring page.

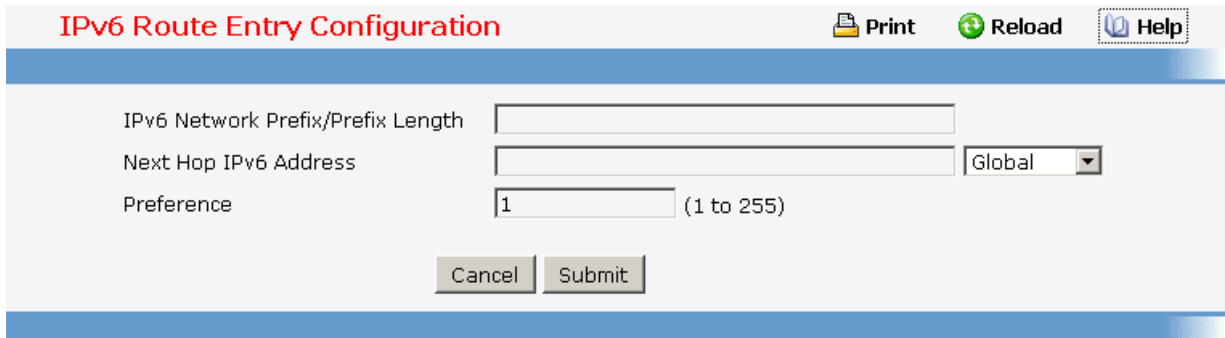

#### 11.2.5.9.2. Viewing IPv6 Route Table Information Page

##### Selection Criteria

##### Routes Displayed -

- Configured Routes - Shows the routes configured by the user
- Best Routes - Shows only the best active routes
- All Routes - Shows all active IPv6 routes

##### Non-Configurable Data

**Number of Routes/Best Routes** - Displays the total number of active routes/best routes in the route table.

**IPv6 Prefix/Prefix Length** - Displays the Network Prefix and Prefix Length for the Active Route.

**Protocol** - Displays the Type of Protocol for the Active Route.

**Next Hop Slot/Port** - Displays the Interface over which the Route is Active.

**Next Hop IP** - Displays the Next Hop IPv6 Address for the Active Route.

### Command Buttons

**Refresh** - Reloads the data on the page.



### 11.2.5.9.3. Configuring IPv6 Router Route Preference Page

Use this panel to configure the default preference for each protocol. These values are arbitrary values in the range of 1 to 255 and are independent of route metrics. Most routing protocols use a route metric to determine the shortest path known to the protocol, independent of any other protocol. The best route to a destination is chosen by selecting the route with the lowest preference value. When there are multiple routes to a destination, the preference values are used to determine the preferred route. If there is still a tie, the route with the best route metric will be chosen. To avoid problems with mismatched metrics you must configure different preference values for each of the protocols.

#### Configurable Data

**Static** - The Static Route preference value for the router. The default value is 1. The range is 1 to 255.

**OSPFv3 Intra** - The OSPFv3 intra route preference value in the router. The default value is 8. The range is 1 to 255. The OSPFv3 specification requires that preferences must be given to the routes learned via OSPFv3 in the following order: intra < inter < type-1 < type-2 .

**OSPFv3 Inter** - The OSPFv3 inter route preference value in the router. The default value is 10. The range is 1 to 255. The OSPFv3 specification requires that preferences must be given to the routes learned via OSPFv3 in the following order: intra < inter < type-1 < type-2 .

**OSPFv3 Type-1** - The OSPFv3 Type-1 route preference value in the router. The default value is 13. The range is 1 to 255. The OSPFv3 specification requires that preferences must be given to the routes learned via OSPFv3 in the following order: intra < inter < type-1 < type-2 .

**OSPFv3 Type-2** - The OSPFv3 intra route preference value in the router. The default value is 150. The range is 1 to 255. The OSPFv3 specification requires that preferences must be given to the routes learned via OSPFv3 in the following order: intra < inter < type-1 < type-2 .



### Non-Configurable Data

**Local** - Local preference.

### Command Buttons

**Submit** - Send the updated configuration to the switch. Configuration changes take effect immediately. These changes will not be retained across a power cycle unless a save is performed.

IPv6 Router Route Preferences

 Print
  Reload
  Help

Local	0	
Static	<input type="text" value="1"/>	(1 to 255)
OSPFv3 Intra	<input type="text" value="8"/>	(1 to 255)
OSPFv3 Inter	<input type="text" value="10"/>	(1 to 255)
OSPFv3 Type-1	<input type="text" value="13"/>	(1 to 255)
OSPFv3 Type-2	<input type="text" value="150"/>	(1 to 255)

#### 11.2.5.9.4. Configuring IPv6 Routes Configuration Page

##### Selection Criteria

##### Routes Displayed -

- Configured Routes - Shows the routes configured by the user
- Best Routes - Shows only the best active routes
- All Routes - Shows all active IPv6 routes

### Non-Configurable Data

**IPv6 Prefix/Prefix Length** - Displays the Network Prefix and Prefix Length for the Configured Route.

**Next Hop IP** - Displays the Next Hop IPv6 Address for the Configured Route.

**Preference** - Displays the Route Preference of the Configured Route.

### Command Buttons

**Add IPv6 Route** - Allows the user to configure a new route.

**Delete** - Deletes the corresponding route.

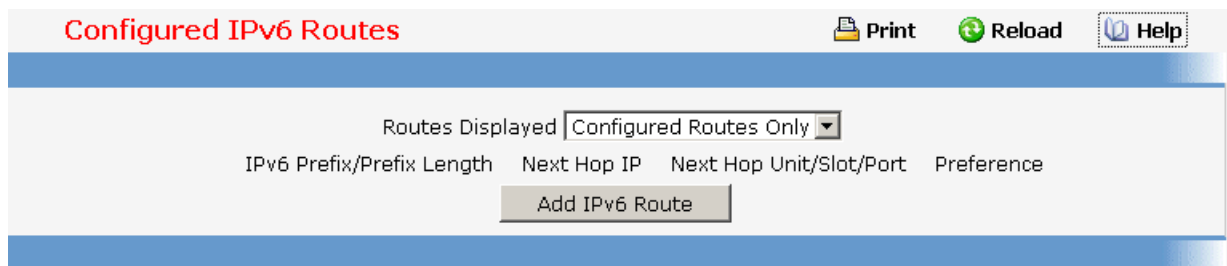

## 11.2.5.10 Managing RIPv6

### 11.2.5.10.1. Configuring RIPv6 Configuration Page

#### Configurable Data

**RIPv6 Admin Mode** - Select enable or disable from the pulldown menu. If you select enable RIPv6 will be enabled for the switch. The default is disable.

**Split Horizon Mode** - Select none, simple or poison reverse from the pulldown menu. Split horizon is a technique for avoiding problems caused by including routes in updates sent to the router from which the route was originally learned. The options are:

**None** - no special processing for this case.

**Simple** - a route will not be included in updates sent to the router from which it was learned.

**Poisoned reverse** - a route will be included in updates sent to the router from which it was learned, but the metric will be set to infinity.

The default is simple.

**Update Time** - Configure the Ripng update time.

**Garbage Time** - Configure the Ripng garbage time.

**Timeout Time** - Configure the Ripng timeout time.



**Default Information Originate** - Enable or Disable Default Route Advertise.

**Default Metric** - Sets a default for the metric of redistributed routes. This field displays the default metric if one has already been set or blank if not configured earlier. The valid values are (1 to 15)

### Command Buttons

**Submit** - Send the updated configuration to the switch. Configuration changes take effect immediately. These changes will not be retained across a power cycle unless a save is performed.

RIPv6 Configuration

 Print
 Reload
 Help

---

RIPv6 Admin Mode	<input type="text" value="Enable"/>	
Split Horizon Mode	<input type="text" value="None"/>	
Update Time	<input type="text" value="5"/>	(5 to 2147483647)
Garbage Time	<input type="text" value="20"/>	(5 to 2147483647)
Timeout Time	<input type="text" value="180"/>	(5 to 2147483647)
Default Information Originate	<input type="text" value="Disable"/>	
Default Metric	<input type="text" value="2"/>	(1 to 15)

### 11.2.5.10.2. Configuring RIPv6 Interface Configuration Page

#### Selection Criteria

**Slot/Port** - Select the interface for which data is to be configured.

#### Configurable Data



**Interface Mode** - Select enable or disable from the pulldown menu. Before you enable RIPv6 version 1 or version 1c on an interface, you must first enable network directed broadcast mode on the corresponding interface. The default value is disable.

**Passive Interface** - Select enable or disable from the pulldown menu. The default value is disable.

#### Command Buttons

**Submit** - Send the updated configuration to the switch. Configuration changes take effect immediately. These changes will not be retained across a power cycle unless a save is performed.

RIPv6 Interface Configuration

 **Print**
 **Reload**
 **Help**

Slot/Port	0/1 <input type="button" value="v"/>
Interface Mode	Enable <input type="button" value="v"/>
Passive Interface	Enable <input type="button" value="v"/>

### 11.2.5.10.3. Configuring RIPv6 Redistribution Configuration Page

This screen can be used to configure the RIPv6 Route Redistribution parameters. The allowable values for each fields are displayed next to the field. If any invalid values are entered, an alert message will be displayed with the list of all the valid values.

#### Configurable Data

**Configured Source** - This select box is a dynamic selector and would be populated by only those Source Routes that have already been configured for redistribute by RIPv6. However, the topmost option in the select box would be "Create", and this allows the user to configure another, among the Available Source Routes. The valid values are

**Create**

**Static**

**Connected**

**OSPF**

**Available Source** - This select box is a dynamic selector and would be populated by only those Source Routes that have not previously been configured for redistribution by RIPv6. This select box would appear only if the user selects "Create" option as Configured Source. The valid values are

**Static**

**Connected**

**OSPF**

**Metric** - Sets the metric value to be used as the metric of redistributed routes. This field displays the metric if the source was pre-configured and can be modified. The valid values are (1 to 15)

**Match** - One or more of these checkboxes must be selected to set the type of OSPF routes to be redistributed. This field would appear only if Source is "OSPF". This field displays the configured match options if "OSPF" was pre-configured and can be modified.

**Internal** - Sets Internal OSPF Routes to be redistributed

**External 1** - Sets External Type 1 OSPF Routes to be redistributed

**External 2** - Sets External Type 2 OSPF Routes to be redistributed

**NSSA-External 1** - Sets NSSA External Type 1 OSPF Routes to be redistributed

**NSSA-External 2** - Sets NSSA External Type 2 OSPF Routes to be redistributed

The default is Internal.

### Command Buttons

**Submit** - Send the updated configuration to the router. Configuration changes take effect immediately.

**Delete** - Delete the entry of the Source Route selected as Configured Source from the list of Sources configured for RIPv6 Route Redistribution.

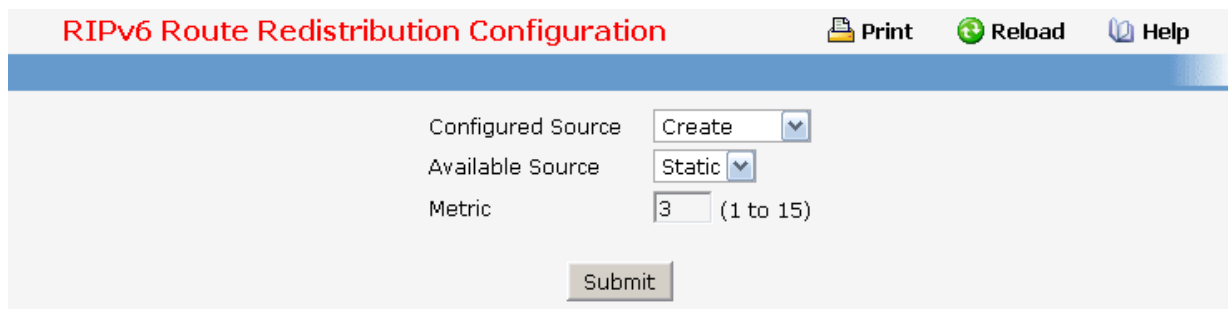

#### 11.2.5.10.4. Configuring RIPv6 Route Redistribution Summary Page

This screen displays the RIPv6 Route Redistribution Configurations.

#### Non Configurable Data

**Source** - The Source Route to be Redistributed by RIPv6.

**Metric** - The Metric of redistributed routes for the given Source Route. Displays "Unconfigured" when not configured.

**Match** - List of Routes redistributed when "OSPF" is selected as Source. The list may include one or more of:

**Internal**



*External 1*



*External 2*

*NSSA-External 1*

*NSSA-External 2*

**Command Buttons**

**Refresh** - Displays the latest RIPv6 Route Redistribution Configuration data.

**RIPv6 Route Redistribution Summary**  Print  Reload  Help

Source	Metric	Match
Connected	3	N.A.

**11.2.6 QOS Menu**

**11.2.6.1 Managing Access Control Lists**

**11.2.6.1.1. Configuring IP Access Control List Configuration Page**

An IP ACL consists of a set of rules which are matched sequentially against a packet. When a packet meets the match criteria of a rule, the specified rule action (Permit/Deny) is taken and the additional rules are not checked for a match. On this menu the interfaces to which an IP ACL applies must be specified, as well as whether it applies to inbound traffic. Rules for the IP ACL are specified/created using the IP ACL Rule Configuration menu.

**Selection Criteria**

**IP ACL** - Make a selection from the pulldown menu. A new IP Access Control List may be created or the configuration of an existing IP ACL can be updated.

**Configurable Data**

**IP ACL ID** - IP ACL ID must be a whole number in the range of 1 to 99 for IP Standard Access Lists and 100 to 199 for IP Extended Access Lists.

**Non-Configurable Data**



**Table** - Displays the current and maximum number of IP ACLs.

**Command Buttons**

**Submit** - Send the updated configuration to the switch. Configuration changes take effect immediately. These changes will not be retained across a power cycle unless a save is performed.

**Delete** - Removes the currently selected IP ACL from the switch configuration.

IP ACL Configuration

 **Print**
 **Reload**
 **Help**

IP ACL

IP ACL ID  (1 to 99)

Table	Current Size / Max Size
ACL	0 / 100

### 11.2.6.1.2. Viewing IP Access Control List Summary Page

#### Non-Configurable Data

**IP ACL ID** - The IP ACL identifier.

**Rules** - The number of rules currently configured for the IP ACL.

**Direction** - The direction of packet traffic affected by the IP ACL.  
Direction can only be:

- **Inbound**

**Slot/Port(s)** - The interfaces to which the IP ACL applies.

#### Command Buttons

**Refresh** - Refresh the data on the screen to the latest state.

IP ACL Summary

 **Print**
 **Reload**
 **Help**

IP ACL ID	Rules	Direction	Slot/Port
1	0		

### 11.2.6.1.3. Configuring IP Access Control List Rule Configuration Page

Use these screens to configure the rules for the IP Access Control Lists created using the IP Access Control List Configuration screen. What is shown on this screen varies depending on the current step in the rule configuration process. A Standard/Extended IP ACL must first be selected to configure rules for. The rule identification, and the 'Action' and 'Match Every' parameters must be specified next. If 'Match Every' is set to false a new screen will then be presented from which the match criteria can be configured.

#### Selection Criteria

**IP ACL ID** - Use the pulldown menu to select the IP ACL for which to create or update a rule.

**Rule** - Select an existing rule from the pulldown menu, or select 'Create New Rule.' ACL as well as an option to add a new Rule. New rules cannot be created if the maximum number of rules has been reached. For each rule, a packet must match all the specified criteria in order to be true against that rule and for the specified rule action (Permit/Deny) to take place.

#### Configurable Data

**Rule ID** - Enter a whole number in the range of 1 to 8 that will be used to identify the rule. An IP ACL may have up to 8 rules.

**Action** - Specify what action should be taken if a packet matches the rule's criteria. The choices are permit or deny.

**Logging** - When set to 'True', logging is enabled for this ACL rule (subject to resource availability in the device). If the Access List Trap Flag is also enabled, this will cause periodic traps to be generated indicating the number of times this rule was 'hit' during the current report interval. A fixed 5 minute report interval is used for the entire system. A trap is not issued if the ACL rule hit count is zero for the current interval. This field is visible for a 'Deny' Action.

**Assign Queue ID** - Specifies the hardware egress queue identifier used to handle all packets matching this IP ACL rule. Valid range of Queue Ids is (0 to 6). This field is visible when 'Permit' is chosen as 'Action'.

**Mirror Interface** - Specifies the specific egress interface where the matching traffic stream is copied in addition to being forwarded normally by the device. This field cannot be set if a Redirect Interface is already configured for the ACL rule. This field is visible for a 'Permit' Action.

**Redirect Interface** - Specifies the specific egress interface where the matching traffic stream is forced, bypassing any forwarding decision normally performed by the device. This field is visible when 'Permit' is chosen as 'Action'.

**Match Every** - Select true or false from the pulldown menu. True signifies that all packets will match the selected IP ACL and Rule and will be either permitted or denied. In this case, since all packets match the rule, the option of configuring other match criteria will

not be offered. To configure specific match criteria for the rule, remove the rule and re-create it, or re-configure 'Match Every' to 'False' for the other match criteria to be visible.

**Protocol Keyword** - Specify that a packet's IP protocol is a match condition for the selected IP ACL rule. The possible values are ICMP, IGMP, IP, TCP, and UDP. Either the 'Protocol Keyword' field or the 'Protocol Number' field can be used to specify an IP protocol value as a match criterion.

**Protocol Number** - Specify that a packet's IP protocol is a match condition for the selected IP ACL rule and identify the protocol by number. The protocol number is a standard value assigned by IANA and is interpreted as an integer from 1 to 255. Either the 'Protocol Number' field or the 'Protocol Keyword' field can be used to specify an IP protocol value as a match criterion.

**Source IP Address** - Enter an IP address using dotted-decimal notation to be compared to a packet's source IP Address as a match criteria for the selected IP ACL rule.

**Source Wildcard Mask** - Specify the IP Mask in dotted-decimal notation to be used with the Source IP Address value.

**Source L4 Port Keyword** - Specify a packet's source layer 4 port as a match condition for the selected extended IP ACL rule. This is an optional configuration. The possible values are DOMAIN, ECHO, FTP, FTPDATA, HTTP, SMTP, SNMP, TELNET, TFTP, and WWW. Each of these values translates into its equivalent port number, which is used as both the start and end of the port range.

**Source L4 Port Number** - Specify a packet's source layer 4 port as a match condition for the selected extended IP ACL rule. This is an optional configuration.

**Destination IP Address** - Enter an IP address using dotted-decimal notation to be compared to a packet's destination IP Address as a match criteria for the selected extended IP ACL rule.

**Destination IP Mask** - Specify the IP Mask in dotted-decimal notation to be used with the Destination IP Address value.

**Destination L4 Port Keyword** - Specify the destination layer 4 port match conditions for the selected extended IP ACL rule. The possible values are DOMAIN, ECHO, FTP, FTPDATA, HTTP, SMTP, SNMP, TELNET, TFTP, and WWW. Each of these values translates into its equivalent port number, which is used as both the start and end of the port range. This is an optional configuration.

**Destination L4 Port Number** - Specify a packet's destination layer 4 port number match condition for the selected extended IP ACL rule. This is an optional configuration.

**Service Type** - Select a Service Type match condition for the extended IP ACL rule from the pulldown menu. The possible values are IP DSCP, IP precedence, and IP TOS, which are alternative ways of specifying a match criterion for the same Service Type field in the IP header, however each uses a different user notation. After a selection is made the appropriate value can be specified.

- **IP DSCP Configuration**

Specify the IP DiffServ Code Point (DSCP) field. The DSCP is defined as the high-order six bits of the Service Type octet in the IP header. This is an optional configuration. Enter an integer from 0 to 63. The IP DSCP is selected by possibly selection one of the DSCP keyword from a dropdown box. If a value is to be selected by specifying its numeric value, then select the 'Other' option in the dropdown box and a text box will appear where the numeric value of the DSCP can be entered.

- **IP Precedence Configuration**

The IP Precedence field in a packet is defined as the high-order three bits of the Service Type octet in the IP header. This is an optional configuration. Enter an integer from 0 to 7.

- **IP TOS Configuration**



The IP TOS field in a packet is defined as all eight bits of the Service Type octet in the IP header. The TOS Bits value is a hexadecimal number from 00 to FF. The TOS Mask value is a hexadecimal number from 00 to FF. The TOS Mask denotes the bit positions in the TOS Bits value that are used for comparison against the IP TOS field in a packet. For example, to check for an IP TOS value having bits 7 and 5 set and bit 1 clear, where bit 7 is most significant, use a TOS Bits value of 0xA0 and a TOS Mask of 0xFF. This is an optional configuration.

### Command Buttons

**Configure** - Configure the corresponding match criteria for the selected rule.



**Delete** - Remove the currently selected Rule from the selected ACL. These changes will not be retained across a power cycle unless a save configuration is performed.

IP ACL Rule Configuration

 **Print**   
  **Reload**   
  **Help**

IP ACL	<input type="text" value="1"/>
Rule	<input type="text" value="Create Rule"/>
Rule ID	<input type="text" value="0"/> (1 to 10)
Action	<input type="text" value="Deny"/>
Match Every	<input type="text" value="False"/>

IP ACL Rule Configuration

 Print
  Reload
  Help

---

IP ACL	<input type="text" value="3"/>	
Rule	<input type="text" value="3"/>	
Action	Permit	<input type="button" value="Configure"/>
Assign Queue ID		<input type="button" value="Configure"/>
Mirror Interface		<input type="button" value="Configure"/>
Redirect Interface		<input type="button" value="Configure"/>
Match Every	True	<input type="button" value="Configure"/>
<input type="button" value="Delete"/>		

Controller time: 2008/1/14 19:46:24

#### 11.2.6.1.4. Configuring IPv6 Access Control List Configuration Page

An IPv6 ACL consists of a set of rules which are matched sequentially against a packet. When a packet meets the match criteria of a rule, the specified rule action (Permit/Deny) is taken and the additional rules are not checked for a match. On this menu the interfaces to which an IPv6 ACL applies must be specified, as well as whether it applies to inbound or outbound traffic. Rules for the IPv6 ACL are specified/created using the IPv6 ACL Rule Configuration menu.

#### Selection Criteria

**IPv6 ACL** - A new IPv6 ACL may be created or the configuration of an existing IPv6 ACL can be updated by selecting right option from the pull down menu.

#### Configurable Data

**IPv6 ACL Name** - Specifies IPv6 ACL Name string which includes alphanumeric characters only. The name must start with an alphabetic character. This field displays the name of the currently selected IPv6 ACL if the ACL has already been created.

#### Non-Configurable Data

**Table** - Displays the current and maximum number of ACLs.



#### Command Buttons

**Submit** - Send the updated configuration to the switch. Configuration changes take effect immediately. These changes will not be retained across a power cycle unless a save is performed.

**Rename** - Rename the currently selected IPv6 ACL.

**Delete** - Removes the currently selected IPv6 ACL from the switch configuration.

**IPv6 ACL Configuration**

 Print
  Reload
  Help

---

IPv6 ACL

IPv6 ACL Name

Table	Current Size / Max Size
ACL	1 / 100

### 11.2.6.1.5. IPv6 Access Control List Summary Page

#### Non-Configurable Data

**IPv6 ACL Name** - Exiting IPv6 ACL identifier.

**Rules** - The number of rules currently configured for the IPv6 ACL.

**Direction** - The direction of packet traffic affected by the IPv6 ACL.  
Direction can only be one of the following:

*Inbound*

**Slot/Port(s)** - The interfaces to which the IPv6 ACL applies.

**VLAN(s)** - VLAN(s) to which the IPv6 ACL applies.

#### Command Buttons

**Refresh** - Refresh the data on the screen to the latest state.

**IPv6 ACL Summary**

 Print
  Reload
  Help

---

IPv6 ACL Name	Rule	Direction	Slot/Port	VLAN ID
A1	1	Inbound	0/1	2

### 11.2.6.1.6. IPv6 Access Control List Rule Configuration Page

Use these screens to configure the rules for the IPv6 Access Control Lists, which is created using the IPv6 Access Control List Configuration screen. By default, no specific value is in effect for any of the IPv6 ACL rules.

#### Selection Criteria

**IPv6 ACL Name** - Use the pull down menu to select the IPv6 ACL for which to create or update a rule.

**Rule** - Select an existing rule from the pull down menu, or select 'Create New Rule.' New rules cannot be created if the maximum number of rules has been reached. For each rule, a packet must match all the specified criteria in order to be true against that rule and for the specified rule action (Permit/Deny) to take place.

### Configurable Data

**Rule ID** - Enter a whole number in the range of (1 to 10) that will be used to identify the rule.

**Action** - Specify what action should be taken if a packet matches the rule's criteria. The choices are permit or deny.

**Logging** - When set to 'True', logging is enabled for this ACL rule (subject to resource availability in the device). If the Access List Trap Flag is also enabled, this will cause periodic traps to be generated indicating the number of times this rule was 'hit' during the current report interval. A fixed 5 minute report interval is used for the entire system. A trap is not issued if the ACL rule hit count is zero for the current interval. This field is visible for a 'Deny' Action.

**Assign Queue ID** - Specifies the hardware egress queue identifier used to handle all packets matching this IPv6 ACL rule. Valid range of Queue Ids is (0 to 7). This field is visible for a 'Permit' Action.

**Mirror Interface** - Specifies the specific egress interface where the matching traffic stream is copied in addition to being forwarded normally by the device. This field cannot be set if a Redirect Interface is already configured for the ACL rule. This field is visible for a 'Permit' Action

**Redirect Interface** - Specifies the specific egress interface where the matching traffic stream is forced, bypassing any forwarding decision normally performed by the device. This field cannot be set if a Mirror Interface is already configured for the ACL rule. This field is visible for a 'Permit' Action.

**Match Every** - Select true or false from the pull down menu. True signifies that all packets will match the selected IPv6 ACL and Rule and will be either permitted or denied. In this case, since all packets match the rule, the option of configuring other match criteria will not be offered. To configure specific match criteria for the rule, remove the rule and re-create it, or re-configure 'Match Every' to 'False' for the other match criteria to be visible.

**Protocol** - There are two ways to configure IPv6 protocol.

Specify an integer ranging from 0 to 255 after selecting protocol keyword "other". This number represents the IP protocol

Select name of a protocol from the existing list of Internet Protocol (IP), Transmission Control Protocol (TCP), User Datagram Protocol (UDP), Internet Control Message Protocol (ICMP) and Internet Group Management Protocol (IGMP).



**Source Prefix / PrefixLength** - Specify IPv6 Prefix combined with IPv6 Prefix length of the network or host from which the packet is being sent. Prefix length can be in the range (0 to 128).

**Source L4 Port** - Specify a packet's source layer 4 port as a match condition for the selected IPv6 ACL rule. Source port information is optional. Source port information can be specified in two ways:

Select keyword "other" from the drop down menu and specify the number of the port in the range from 0 to 65535.

Select one of the keyword from the list: DOMAIN, ECHO, FTP, FTPDATA, HTTP, SMTP, SNMP, TELNET, TFTP, and WWW. Each of these values translates into its equivalent port number, which is used as both the start and end of the port range.

**Destination Prefix / PrefixLength** - Enter up to 128-bit prefix combined with prefix length to be compared to a packet's destination IP Address as a match criteria for the selected IPv6 ACL rule. Prefix length can be in the range (0 to 128).

**Destination L4 Port Keyword** - Specify the destination layer 4 port match conditions for the selected IPv6 ACL rule. The possible values are DOMAIN, ECHO, FTP, FTPDATA, HTTP, SMTP, SNMP, TELNET, TFTP, and WWW. Each of these values translates into its equivalent port number, which is used as both the start and end of the port range. This is an optional configuration.

**Destination L4 Port Number** - Specify a packet's destination layer 4 port number match condition for the selected IPv6 ACL rule. This is an optional configuration.

**Flow Label** - Flow label is 20-bit number that is unique to an IPv6 packet, used by end stations to signify quality-of-service handling in routers. Flow label can be specified within the range (0 to 1048575).



**IPv6 DSCP Service** - Specify the IP DiffServ Code Point (DSCP) field. The DSCP is defined as the high-order six bits of the Service Type octet in the IPv6 header. This is an optional configuration. Enter an integer from 0 to 63. The IPv6 DSCP is selected by possibly selection one of the DSCP keyword from a dropdown box. If a value is to be selected by specifying its numeric value, then select the 'Other' option in the dropdown box and a text box will appear where the numeric value of the DSCP can be entered.

## Command Buttons

**Configure** - Configure the corresponding match criteria for the selected rule.

**Delete** - Remove the currently selected Rule from the selected ACL. These changes will not be retained across a power cycle unless a save configuration is performed.

IPv6 ACL Rule Configuration

 Print
  Reload
  Help

---

IPv6 ACL	A1 <input type="button" value="v"/>	
Rule	1 <input type="button" value="v"/>	
Action	Permit	<input type="button" value="Configure"/>
Logging	False	<input type="button" value="Configure"/>
Assign Queue ID	1	<input type="button" value="Configure"/>
Mirror Interface	0/2	<input type="button" value="Configure"/>
Match Every	False	<input type="button" value="Configure"/>
Protocol	2 (IGMP)	<input type="button" value="Configure"/>
Source Prefix/PrefixLength	2001:2001:2001:2001::1111:1111/128	<input type="button" value="Configure"/>
Source L4 Port	20 (ftpdata)	<input type="button" value="Configure"/>
Destination Prefix/PrefixLength	2001:2001:2001::1234:3325:0/128	<input type="button" value="Configure"/>
Destination L4 Port	7 (echo)	<input type="button" value="Configure"/>
Flow Label	42	<input type="button" value="Configure"/>
IP DSCP Service	14 (AF-13)	<input type="button" value="Configure"/>

### 11.2.6.1.7. Configuring MAC Access Control List Configuration Page

A MAC ACL consists of a set of rules which are matched sequentially against a packet. When a packet meets the match criteria of a rule, the specified rule action (Permit/Deny) is taken and the additional rules are not checked for a match. On this menu the interfaces to which an MAC ACL applies must be specified, as well as whether it applies to inbound or outbound traffic. Rules for the MAC ACL are specified/created using the MAC ACL Rule Configuration menu.

#### Selection Criteria

**MAC ACL** - A new MAC Access Control List may be created or the configuration of an existing MAC ACL can be updated based on selection.

#### Configurable Data

**MAC ACL Name** - Specifies MAC ACL Name string which may include alphabetic, numeric, dash, underscore or space characters only. The name must start with an alphabetic character. This field displays the name of the currently selected MAC ACL if the ACL has already been created.

#### Command Buttons

**Submit** - Send the updated configuration to the switch. Configuration changes take effect immediately. These changes will not be retained across a power cycle unless a save is performed.

**Rename** - Renames the currently selected MAC ACL.

**Delete** - Removes the currently selected MAC ACL from the switch configuration.

**MAC ACL Configuration** Print Reload Help

MAC ACL

MAC ACL Name

Table	Current Size / Max Size
ACL	1 / 100

### 11.2.6.1.8. Viewing MAC Access Control List Summary Page

#### Non-Configurable Data

**MAC ACL Name** - MAC ACL identifier.

**Rules** - The number of rules currently configured for the MAC ACL.

**Direction** - The direction of packet traffic affected by the MAC ACL.  
Valid Directions

- **Inbound**

**Slot/Port** - The interfaces to which the MAC ACL applies.

#### Command Buttons

**Refresh** - Refresh the data on the screen to the latest state.

**MAC ACL Summary** Print Reload Help

MAC ACL Name	Rules	Direction	Slot/Port
hello	0		

### 11.2.6.1.9. Configuring MAC Access Control List Rule Configuration Page

#### Selection Criteria

**MAC ACL** - Select the MAC ACL for which to create or update a rule.

**Rule** - Select an existing rule or select 'Create New Rule' to add a new Rule. New rules cannot be created if the maximum number of rules has been reached. For each rule, a packet must match all the specified criteria in order to be true against that rule and for the specified rule action (Permit/Deny) to take place.

### Configurable Data

**Rule** - Enter a whole number in the range of (1 to 8) that will be used to identify the rule.

**Action** - Specify what action should be taken if a packet matches the rule's criteria. The choices are permit or deny.

**Logging** - When set to 'True', logging is enabled for this ACL rule (subject to resource availability in the device). If the Access List Trap Flag is also enabled, this will cause periodic traps to be generated indicating the number of times this rule was 'hit' during the current report interval. A fixed 5 minute report interval is used for the entire system. A trap is not issued if the ACL rule hit count is zero for the current interval. This field is visible for a 'Deny' Action.

**Assign Queue ID** - Specifies the hardware egress queue identifier used to handle all packets matching this ACL rule. Valid range of Queue Ids is (0 to 6).

**Mirror Interface** - Specifies the specific egress interface where the matching traffic stream is copied in addition to being forwarded normally by the device. This field cannot be set if a Redirect Interface is already configured for the ACL rule. This field is visible for a 'Permit' Action.

**Redirect Interface** - Specifies the specific egress interface where the matching traffic stream is forced, bypassing any forwarding decision normally performed by the device.

**CoS** - Specifies the 802.1p user priority to compare against an Ethernet frame. Valid range of values is (0 to 7).

**Secondary CoS** - Specifies the Secondary 802.1p user priority to compare against an Ethernet frame. Valid range of values is (0 to 7).

**Destination MAC** - Specifies the destination MAC address to compare against an Ethernet frame. Valid format is (xx:xx:xx:xx:xx:xx). The BPDU keyword may be specified using a Destination MAC address of 01:80:C2:xx:xx:xx.

**Ethertype Key** - Specifies the Ethertype value to compare against an Ethernet frame. Valid values are

- **Appletalk**
- **ARP**
- **IBM SNA**
- **IPv4**
- **IPv6**
- **IPX**

- **MPLS multicast**
- **MPLS unicast**
- **NetBIOS**
- **Novell**
- **PPPoE**
- **Reverse ARP**
- **User Value**

**Ethertype User Value** - Specifies the user defined customised Ethertype value to be used when the user has selected "User Value" as Ethertype Key, to compare against an Ethernet frame. Valid range of values is (0x0600 to 0xFFFF).

**Source MAC** - Specifies the Source MAC address to compare against an Ethernet frame. Valid format is (xx:xx:xx:xx:xx:xx).

**VLAN** - Specifies the VLAN ID to compare against an Ethernet frame. Valid range of values is (1 to 3965). Either VLAN Range or VLAN can be configured.

**Secondary VLAN** - Specifies the Secondary VLAN ID to compare against an Ethernet frame. Valid range of values is (0 to 4095). Either Secondary VLAN Range or Secondary VLAN can be configured.

**Match Every** - Specifies an indication to match every Layer 2 MAC packet. Valid values are



- **True** - Signifies that every packet is considered to match the selected ACL Rule.
- **False** - Signifies that it is not mandatory for every packet to match the selected ACL Rule.

### Command Buttons

**Submit** - Send the updated configuration to the switch. Configuration changes take effect immediately. These changes will not be retained across a power cycle unless a save is performed.

**Delete** - Remove the currently selected Rule from the selected ACL. These changes will not be retained across a power cycle unless a save configuration is performed.

**MAC ACL Rule Configuration**

 Print
  Reload
  Help

MAC ACL



Rule

Rule ID  (1 to 10)

Action

Match Every

MAC ACL Rule Configuration

 Print
  Reload
  Help

---

MAC ACL	abc		
Rule	2		
Action	Deny		<input type="button" value="Configure"/>
Logging	False		<input type="button" value="Configure"/>
Match Every	False		<input type="button" value="Configure"/>
CoS			<input type="button" value="Configure"/>
Secondary COS			<input type="button" value="Configure"/>
Destination MAC			<input type="button" value="Configure"/>
Destination MAC Mask			
Ethertype Key			<input type="button" value="Configure"/>
Source MAC			<input type="button" value="Configure"/>
Source MAC Mask			
VLAN			<input type="button" value="Configure"/>
Secondary VLAN			<input type="button" value="Configure"/>

Controller time: 2008/1/14 19:53:16

### 11.2.6.1.10. Configuring Access Control List Interface Configuration Page

#### Configurable Data

**Slot/Port** - Specifies list of all available valid interfaces for ACL mapping. All non-routing physical interfaces and interfaces participating in LAGs are listed.

**Direction** - Specifies the packet filtering direction for ACL.  
Valid Directions

- ***Inbound***

**ACL Type** - Specifies the type of ACL.  
Valid ACL Types

- ***IP ACL***
- ***MAC ACL***

**IP ACL** - Specifies list of all IP ACLs. This field is visible only if the user has selected "IP ACL" as "ACL Type".

**IPv6 ACL** - Specifies list of all IPv6 ACLs. This field is visible only if the user has selected "IPv6 ACL" as "ACL Type".

**MAC ACL** - Specifies list of all MAC ACLs. This field is visible only if the user has

selected "MAC ACL" as "ACL Type".

**Sequence Number** - An optional sequence number may be specified to indicate the order of this access list relative to other access lists already assigned to this interface and direction. A lower number indicates higher precedence order. If a sequence number is already in use for this interface and direction, the specified access list replaces the currently attached access list using that sequence number. If the sequence number is not specified by the user, a sequence number that is one greater than the highest sequence number currently in use for this interface and direction will be used. Valid range is (1 to 4294967295).

### Non-Configurable Data

**Slot/Port** - Displays selected interface.

**Direction** - Displays selected packet filtering direction for ACL.

**ACL Type** - Displays the type of ACL assigned to selected interface and direction.



**ACL Identifier** - Displays the ACL Number(in case of IP ACL) or ACL Name(in case of MAC ACL) identifying the ACL assigned to selected interface and direction.

**Sequence Number** - Displays the Sequence Number signifying the order of specified ACL relative to other ACLs assigned to selected interface and direction.

### Command Buttons

**Submit** - Send the updated configuration to the switch. Configuration changes take effect immediately. These changes will not be retained across a power cycle unless a save is performed.

ACL Interface Configuration

 **Print**
 **Reload**
 **Help**

---

Slot/Port 0/1

Direction Inbound

ACL Type IPv6 ACL

IPv6 ACL A1

Sequence Number 43 (1 to 4294967295)

List of Assigned ACLs

Slot/Port	Direction	ACL Type	ACL Identifier	Sequence Number
0/1	Inbound	IPv6 ACL	A1	43

### 11.2.6.1.11. Configuring Access Control List VLAN ACL Configuration Page

#### Configurable Data

**VLAN ID** - Specifies list of all configured VLAN Id(s) for ACL mapping.

**Direction** - Specifies the packet filtering direction for ACL.

Valid Directions

***Inbound***

**ACL Type** - Specifies the type of ACL.

Valid ACL Types

***IP ACL***

***IPv6 ACL***

***MAC ACL***

**IP ACL** - Specifies list of all IP ACLs. This field is visible only if the user has selected "IP ACL" as "ACL Type".

**IPv6 ACL** - Specifies list of all IPv6 ACLs. This field is visible only if the user has selected "IPv6 ACL" as "ACL Type".

**MAC ACL** - Specifies list of all MAC ACLs. This field is visible only if the user has selected "MAC ACL" as "ACL Type".

**Sequence Number** - An optional sequence number may be specified to indicate the order of this access list relative to other access lists already assigned to this VLAN and direction. A lower number indicates higher precedence order. If a sequence number is already in use for this VLAN and direction, the specified access list replaces the currently attached access list using that sequence number. If the sequence number is not specified by the user, a sequence number that is one greater than the highest sequence number currently in use for this VLAN and direction will be used. Valid range is (1 to 4294967295).

### **Non-Configurable Data**

**Slot/Port** - Displays selected interface

**VLAN ID(s)** - Displays selected VLAN Id.

**Direction** - Displays selected packet filtering direction for ACL.

**ACL Type** - Displays the type of ACL assigned to selected VLAN and direction.

**ACL Identifier** - Displays the ACL Number(in case of IP ACL) or ACL Name(in case of IPv6 ACL and MAC ACL) identifying the ACL assigned to selected VLAN and direction.

**Sequence Number** - Displays the Sequence Number signifying the order of specified





ACL relative to other ACLs assigned to selected VLAN and direction.

### Non-Configurable Data

**Submit** - Send the updated configuration to the switch. Configuration changes take effect immediately. These changes will not be retained across a power cycle unless a save is performed.

**Remove** - Removes the currently selected ACL VLAN Direction Mapping from the switch configuration.

**VLAN Based ACL Configuration**

 Print
  Reload
  Help

---

VLAN ID

Direction

ACL Type

IPv6 ACL

Sequence Number  (1 to 4294967295)

List of Assigned ACLs

VLAN ID	Direction	ACL Type	ACL Identifier	Sequence Number
1	Inbound	IPv6 ACL	aaa	1

### 11.2.6.1.12. Access Control List VLAN ACL Summary Page

#### Non-Configurable Data

**Summary Display Selector** - Select interface or VLAN to display summary. By default summary of Interface-based ACL(s) is displayed.

**Slot/Port(s)** - The interfaces to which the IP ACL applies.

**VLAN(s)** - VLAN(s) to which the IP ACL applies.

**Direction** - The direction of packet traffic affected by the IP ACL.

Direction can only be one of the following:

***Inbound***

**ACL Type** - Displays the type of ACL assigned to selected VLAN and direction.

**ACL Identifier** - Displays the ACL Number(in case of IP ACL) or ACL Name(in case of IPv6 ACL and MAC ACL) identifying the ACL assigned to selected VLAN and direction.

**Sequence Number** - Displays the Sequence Number signifying the order of specified ACL relative to other ACLs assigned to selected VLAN and direction.

## Command Buttons

**Refresh** - Refresh the data on the screen to the latest state.

Interface or VLAN based ACL(s) Summary
Print
Reload
Help

**Summary Display Selector**

Slot/Port	Direction	ACL Type	ACL Identifier	Sequence Number
0/1	Inbound	IPv6 ACL	aaa	23

Interface ▼

### 11.2.6.2 Managing Differentiated Services

#### 11.2.6.2.1. Defining DiffServ Configuration Page

##### Operation

Packets are filtered and processed based on defined criteria. The filtering criteria is defined by a class. The processing is defined by a policy's attributes. Policy attributes may be defined on a per-class instance basis, and it is these attributes that are applied when a match occurs.

The configuration process begins with defining one or more match criteria for a class. Then one or more classes are added to a policy. Policies are then added to interfaces.

Packet processing begins by testing the match criteria for a packet. The 'all' class type option defines that each match criteria within a class must evaluate to true for a packet to match that class. The 'any' class type option defines that at least one match criteria must evaluate to true for a packet to match that class. Classes are tested in the order in which they were added to the policy. A policy is applied to a packet when a class match within that policy is found.

##### Selection Criteria

**DiffServ Admin Mode** - This lists the options for the mode, from which one can be selected. The default value is 'enable'. While disabled, the DiffServ configuration is retained when saved and can be changed, but it is not activated. When enabled, DiffServ services are activated.

##### Non-Configurable Data

**Class table** - Displays the number of configured DiffServ classes out of the total allowed on the switch.

**Class Rule table** - Displays the number of configured class rules out of the total allowed on the switch.

**Policy table** - Displays the number of configured policies out of the total allowed on the switch.

**Policy Instance table** - Displays the number of configured policy class instances out of the total allowed on the switch.

**Policy Attributes table** - Displays the number of configured policy attributes (attached to

the policy class instances) out of the total allowed on the switch.

**Service table** - Displays the number of configured services (attached to the policies on specified interfaces) out of the total allowed on the switch.

### Command Buttons

**Submit** - Send the updated configuration to the switch. Configuration changes take effect immediately. These changes will not be retained across a power cycle unless a save is performed.

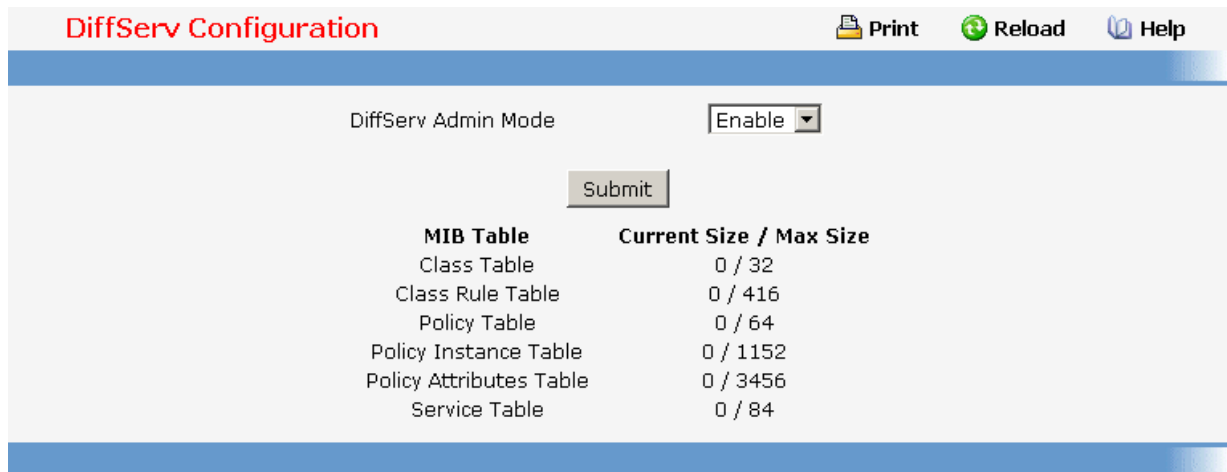

DiffServ Configuration Print Reload Help

DiffServ Admin Mode Enable

Submit

MIB Table	Current Size / Max Size
Class Table	0 / 32
Class Rule Table	0 / 416
Policy Table	0 / 64
Policy Instance Table	0 / 1152
Policy Attributes Table	0 / 3456
Service Table	0 / 84

### 11.2.6.2.2. Configuring DiffServ Class Configuration Page

#### Selection Criteria

**Class Selector** - Along with an option to create a new class, this lists all the existing DiffServ class names, from which one can be selected. The content of this screen varies based on the selection of this field. If an existing class is selected then the screen will display the configured class. If '--create--' is selected, another screen appears to facilitate creation of a new class. The default is the first class created. If no classes exist, the default is '--create--'.

**Class Type** - This lists all the platform supported DiffServ class types from which one can be selected. Possible options are 'all', 'any', or 'acl'. If 'acl' is (supported and) selected, then an access list (ACL) number is required which is an integer specifying an existing ACL. Only when a new class is created, is this field a selector field. After class creation this becomes a non-configurable field displaying the configured class type.

**Class Match Selector** - This lists all match criteria from which one can be selected to be added to a specified class. The match criterion 'Every' denotes that every packet is considered to match the specified class and no additional input information is needed. The content of this drop down list varies for a specified class based on the selection of the match criterion 'Reference Class':

If the specified class does not reference any other class, the 'Reference Class' match criterion is included in the drop down match criteria list. A class reference can be established by selecting 'Reference Class' and invoking the 'Add Match Criteria' button.

If the specified class references another class, the 'Reference Class' match criterion is not included in the drop down match criteria list. This prevents the user from trying to

add yet another class reference, since a specified class can reference at most one other class of the same type. Moreover, a 'Remove Class Reference' button appears on the screen that can be invoked to remove the current class reference.

### Configurable Data

**Class Name** - This is a case-sensitive alphanumeric string from 1 to 31 characters uniquely identifying a class. Class name 'default' is reserved and must not be used.

### Non-Configurable Data

**Class Type** - Displays type of the configured class as 'all', 'any', or 'acl'. Only when a new class is created, is this field a selector field. After class creation this becomes a non-configurable field.

**Match Criteria** - Displays the configured match criteria for the specified class.

**Values** - Displays the values of the configured match criteria.

### Command Buttons

**Submit** - Send the updated screen to the switch and cause the changes to take effect on the switch but these changes will not be retained across a power cycle unless a save is performed.

**Cancel** - Cancel the currently selected filter.

**Delete** - Delete the currently selected filter.

**Rename** - Allows to rename a specified class.

**Add Match Criteria** - Only one match criterion can be specified each time this button is invoked. Based on the selected match criterion, an individual match criterion screen is provided to configure its value.

NOTE: Match criteria cannot be deleted from a class. The class must be deleted in order to remove the match criteria.

Remove Class Reference - This button appears on the screen only if a specified class references another class. The current class reference, of the specified class, is removed by invoking this button.

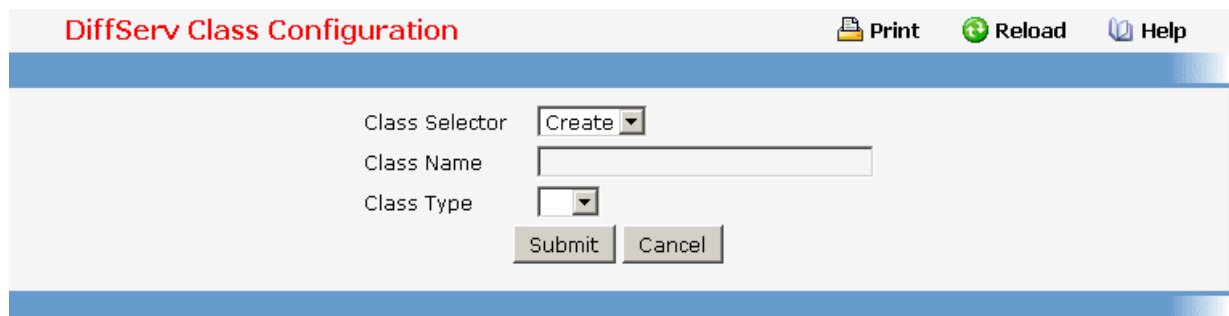

### 11.2.6.2.3. Viewing DiffServ Class Summary Page

#### Non-Configurable Data

**Class Name** - Displays names of the configured DiffServ classes.

**Class Type** - Displays types of the configured classes as 'all', 'any', or 'acl'. Class types are platform dependent.

**Reference Class** - Displays name of the configured class of type

- All

referenced by the specified class of the same type.

### Command Buttons

**Refresh** - Refresh the currently selected filter.

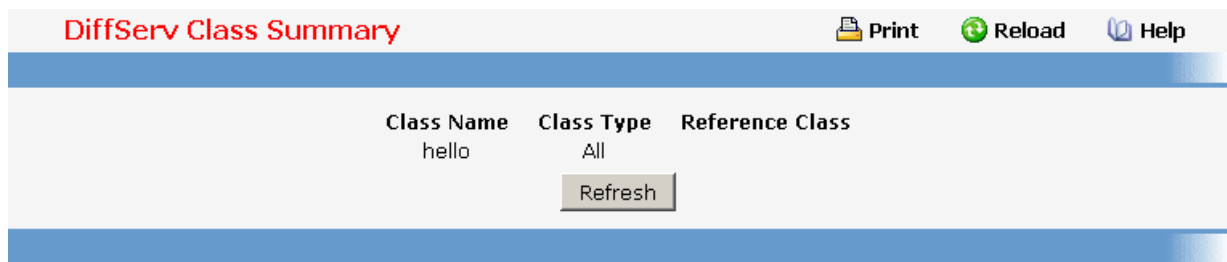

### 11.2.6.2.4. DiffServ Policy Configuration Page

#### Selection Criteria

**Policy Selector** - Along with an option to create a new policy, this lists all the existing DiffServ policy names, from which one can be selected. The content of this screen varies based on the selection of this field. If an existing policy is selected then the screen will display Member Classes for that DiffServ policy. If 'create' is selected, another screen appears to facilitate creation of a new policy. The default is 'create'.

**Policy Type** - *In* indicates the type is specific to inbound traffic direction. Only when a new policy is created, this field is a selector field. After policy creation this becomes a non-configurable field displaying the configured policy type.

**Available Class List** - This lists all existing DiffServ class names, from which one can be selected. This field is a selector field only when a new policy class instance is to be created. After creation of the policy class instance this becomes a non-configurable field.

**Member Class List** - This lists all existing DiffServ classes currently defined as members of the specified Policy, from which one can be selected. This list is automatically updated as a new class is added to or removed from the policy. This field is a selector field only when an existing policy class instance is to be removed. After removal of the policy class instance this becomes a non-configurable field.

#### Configurable Data

**Policy Name** - This is a case-sensitive alphanumeric string from 1 to 31 characters uniquely identifying a policy.

#### Non-Configurable Data

**Policy Type** - *In* indicates the type is specific to inbound traffic direction. Only when a new policy is created, this field is a selector field. After policy creation this becomes a non-configurable field displaying the configured policy type.

**Member Class List** - Displays all the member classes for the selected DiffServ policy. It is automatically updated as a new class is added to or removed from the policy. Only when an existing policy class instance is to be removed, is this field a selector field. After removal of the policy class instance this becomes a non-configurable field.

**Available Class List** - Displays all the member classes for the specified policy. It is automatically updated as a new class is added to or removed from the policy. Only when a new policy class instance is to be created is this field a selector field. After creation of the policy class instance this becomes a non-configurable field.

### Command Buttons

**Submit** - Send the updated screen to the switch and cause the changes to take effect on the switch but these changes will not be retained across a power cycle unless a save is performed.

**Delete** - Delete the currently selected filter.

**Rename** - Allows to rename a specified policy.

**Add Selected Class** - Creates a policy class instance by attaching the policy to the specified class.

**Remove Selected Class** - Removes a policy class instance by detaching the policy from the specified class.

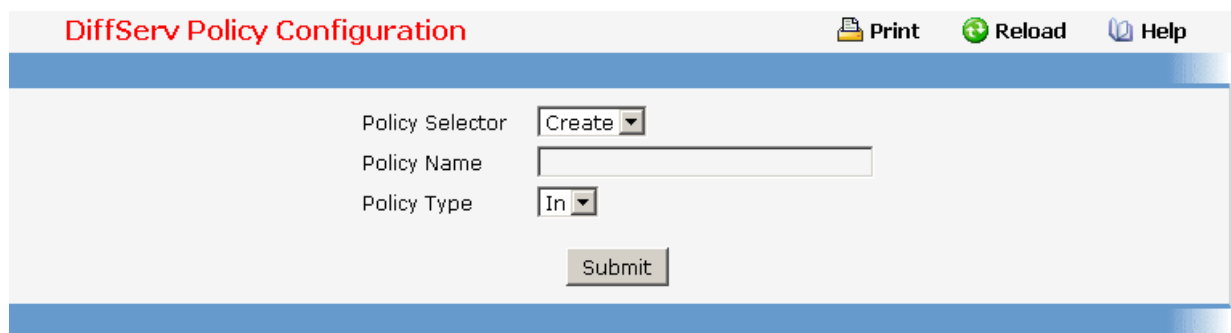

**DiffServ Policy Configuration** Print Reload Help

Policy Selector:

Policy Name:

Policy Type:

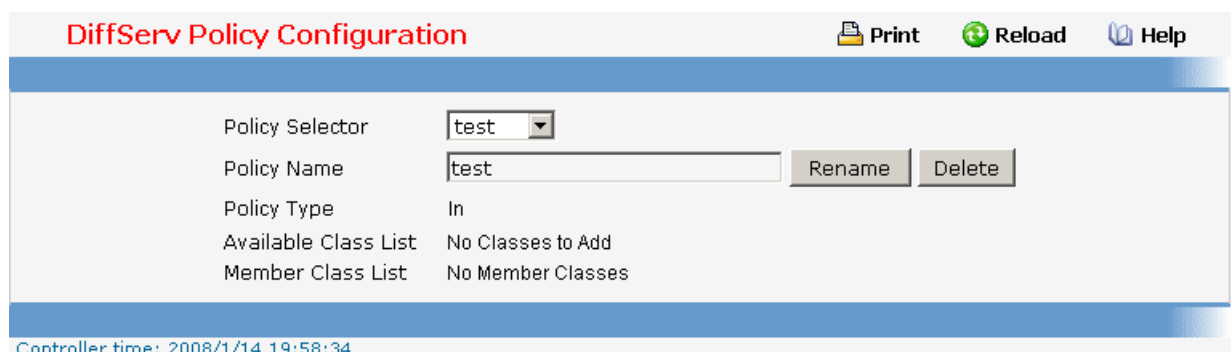

**DiffServ Policy Configuration** Print Reload Help

Policy Selector:

Policy Name:

Policy Type: In

Available Class List: No Classes to Add

Member Class List: No Member Classes

Controller time: 2008/1/14 19:58:34

### 11.2.6.2.5. Viewing DiffServ Policy Summary Page

#### Non-Configurable Data

**Policy Name** - Displays name of the DiffServ policy.

**Policy Type** - Displays type of the policy as 'In'.

**Member Classes** - Displays name of each class instance within the policy.

**Command Buttons**

**Refresh** – Refresh the currently selected filter.

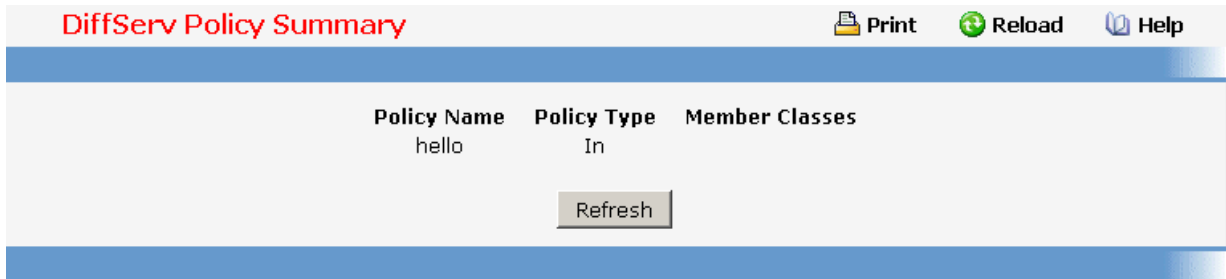

**11.2.6.2.6. Configuring DiffServ Policy Class Definition Page**

**Selection Criteria**

**Policy Selector** - This lists all the existing DiffServ policy names, from which one can be selected.

**Member Class List** - This lists all existing DiffServ classes currently defined as members of the specified Policy, from which one can be selected. This list is automatically updated as a new class is added to or removed from the policy.

**Policy Attribute Selector** - This lists all attributes supported for this type of policy, from which one can be selected.

**Non-Configurable Data**

**Policy Type** - Displays type of the configured policy as 'In'.

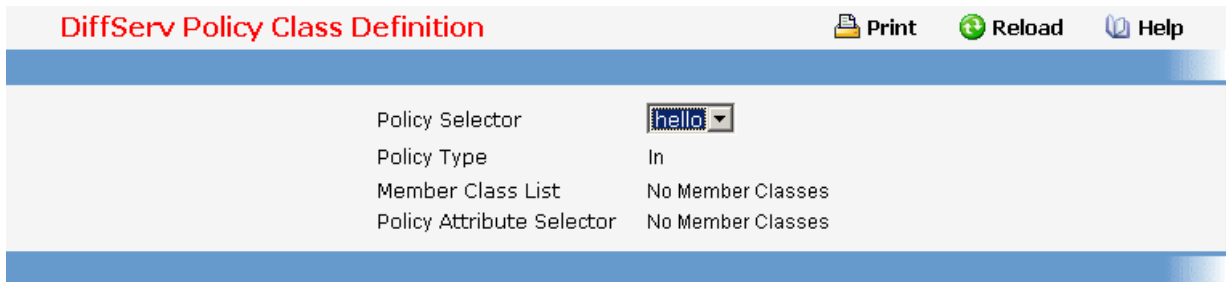

**11.2.6.2.7. Viewing DiffServ Policy Attribute Summary Page**

**Non-Configurable Data**

**Policy Name** - Displays name of the specified DiffServ policy.

**Policy Type** - Displays type of the specified policy as 'In' or 'Out'.

**Class Name** - Displays name of the DiffServ class to which this policy is attached.

**Attribute** - Displays the attributes attached to the policy class instances.

**Attribute Details** - Displays the configured values of the attached attributes.

**Command Buttons**

**Refresh** - Refresh the displayed data.

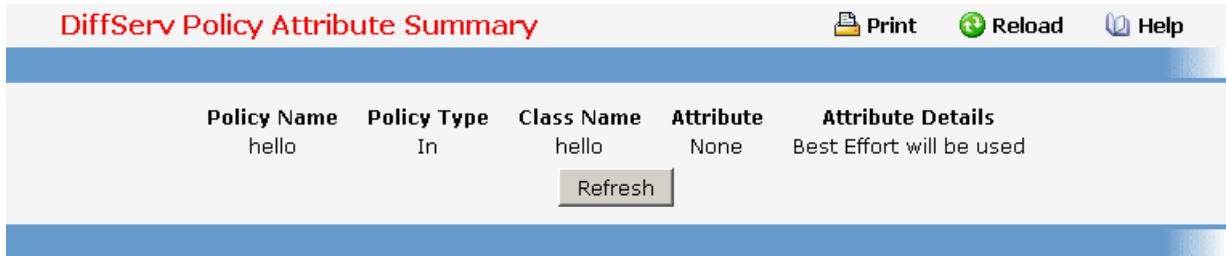

The screenshot shows a web interface titled "DiffServ Policy Attribute Summary". At the top right, there are three icons: a printer for "Print", a circular arrow for "Reload", and a question mark for "Help". Below the title bar is a table with the following data:

Policy Name	Policy Type	Class Name	Attribute	Attribute Details
hello	In	hello	None	Best Effort will be used

Below the table is a "Refresh" button.

**11.2.6.2.8. Configuring DiffServ Service Configuration Page**

**Selection Criteria**

**Slot/Port** - Select the Slot/Port that uniquely specifies an interface. This is a list of all valid slot number and port number combinations in the system. For Read/Write users where 'All' appears in the list, select it to specify all interfaces.

**Direction** - Select the traffic direction of this service interface. This selection is only available to Read/Write users when Slot/Port is specified as 'All'.

**Configurable Data**

**Policy In** - This lists all the policy names of type 'In' from which one can be selected. If 'none' is selected, this will detach the policy from the interface in this direction. This field is not shown for Read/Write users where inbound service policy attachment is not supported by the platform.

**Non-Configurable Data**

This information is only displayed when Slot/Port is specified as 'All'.

**Slot/Port** - Shows the Slot/Port that uniquely specifies an interface.

**Direction** - Shows the traffic direction of this service interface.

**Operational Status** - Shows the operational status of this service interface, either Up or Down.

**Policy Name** - Shows the name of the attached policy.

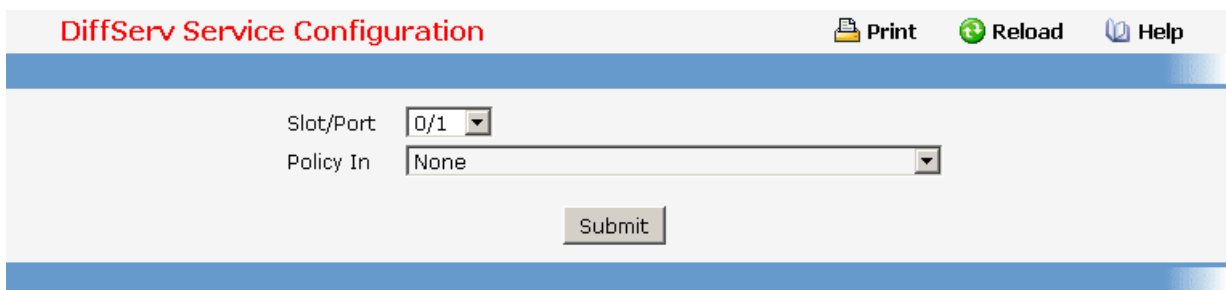

The screenshot shows a web interface titled "DiffServ Service Configuration". At the top right, there are three icons: a printer for "Print", a circular arrow for "Reload", and a question mark for "Help". Below the title bar are two dropdown menus:

- Slot/Port: 0/1
- Policy In: None

Below the dropdown menus is a "Submit" button.



### 11.2.6.2.9. Viewing DiffServ Service Summary Page

#### Non-Configurable Data

**Slot/Port** - Shows the Slot/Port that uniquely specifies an interface.

**Direction** - Shows the traffic direction of this service interface, either In or Out.

**Operational Status** - Shows the operational status of this service interface.

**Policy Name** - Shows the name of the attached policy.

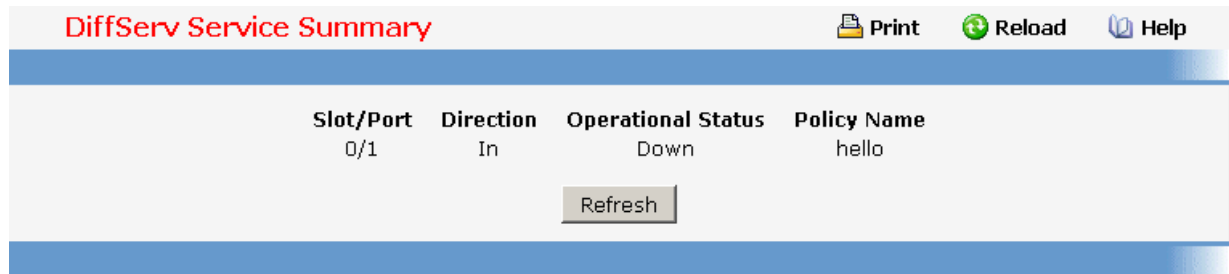

Slot/Port	Direction	Operational Status	Policy Name
0/1	In	Down	hello

### 11.2.6.2.10. Viewing DiffServ Service Statistics Page

This screen displays service-level statistical information in tabular form for all interfaces in the system to which a DiffServ policy has been attached in the inbound and/or outbound traffic directions. Use the 'Counter Mode Selector' to specify the counter display mode as either octets or packets (the default).

#### Non-Configurable Data

**Slot/Port** - Shows the Slot/Port that uniquely specifies an interface.

**Direction** - Shows the traffic direction of this service interface.

**Operational Status** - Shows the operational status of this service interface, either Up or Down.

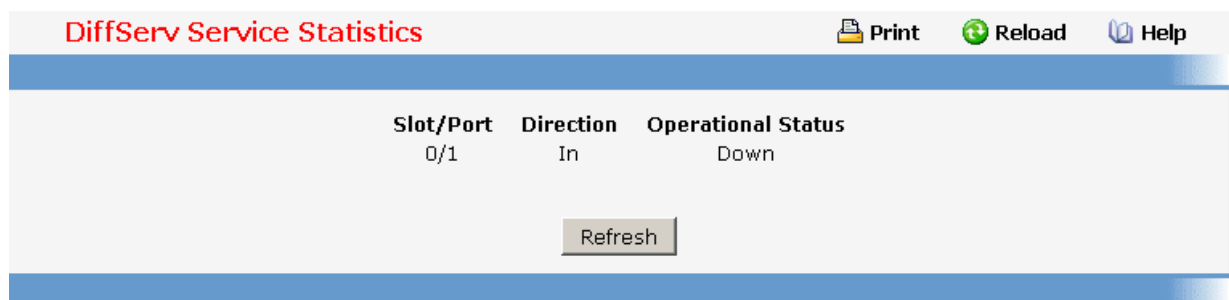

Slot/Port	Direction	Operational Status
0/1	In	Down

### 11.2.6.2.11. Viewing DiffServ Service Detailed Statistics Page

This screen displays class-oriented statistical information for the policy, which is specified by the interface and direction. The 'Member Classes' drop down list is populated on the basis of the specified interface and direction and hence the attached policy (if any). Highlighting a member class name displays the statistical information for the policy-class instance for the

specified interface and direction.

### Selection Criteria

**Slot/Port** - List of all valid slot number and port number combinations in the system that have a DiffServ policy currently attached (in either direction), from which one can be chosen.

**Direction** - List of the traffic direction of interface. Only shows the direction(s) for which a DiffServ policy is currently attached.

**Member Classes** - List of all DiffServ classes currently defined as members of the selected Policy Name. Choose one member class name at a time to display its statistics. If no class is associated with the chosen policy then nothing will be populated in the list.

### Non-Configurable Data

**Policy Name** - Name of the policy currently attached to the specified interface and direction.

**Operational Status** - Operational status of the policy currently attached to the specified interface and direction. The value is either Up or Down.

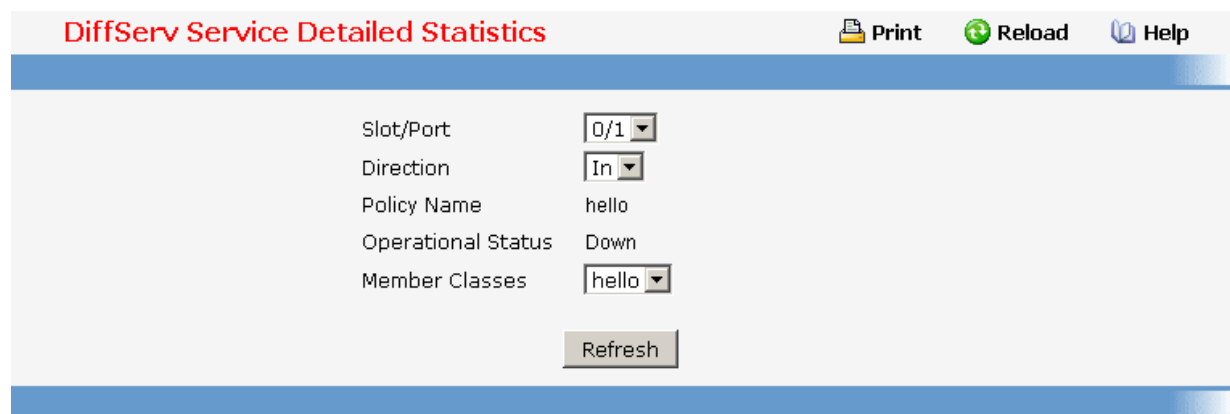

The screenshot shows a web interface titled "DiffServ Service Detailed Statistics". At the top right, there are three icons: "Print", "Reload", and "Help". Below the title bar, there is a form with the following fields:

- Slot/Port: 0/1 (dropdown menu)
- Direction: In (dropdown menu)
- Policy Name: hello
- Operational Status: Down
- Member Classes: hello (dropdown menu)

At the bottom of the form, there is a "Refresh" button.

### 11.2.6.3 Configuring Diffserv Wizard Page

#### Operation

The DiffServ Wizard enables DiffServ on the switch by creating a traffic class, adding the traffic class to a policy, and then adding the policy to the ports selected on DiffServ Wizard page. The DiffServ Wizard will:

Create a DiffServ Class and define match criteria used as a filter to determine if incoming traffic meets the requirements to be a member of the class.

Set the DiffServ Class match criteria based on Traffic Type selection as below:

VOIP - sets match criteria to UDP protocol.

HTTP - sets match criteria to HTTP destination port.

FTP - sets match criteria to FTP destination port.

Telnet - sets match criteria to Telnet destination port.

Any - sets match criteria to all traffic.

Create a DiffServ Policy and adds the DiffServ Policy to the DiffServ Class created.

If Policing is set to YES, then DiffServ Policy style is set to Simple. Traffic which conforms to the Class Match criteria will be processed according to the Outbound Priority selection. Outbound Priority configures the handling of conforming traffic as below:

High - sets policing action to markdscp ef.

Med - sets policing action to markdscp af31.

Low - sets policing action to send.

If Policing is set to NO, then all traffic will be marked as specified below:

High - sets policy mark ipdscp ef.

Med - sets policy mark ipdscp af31.

Low - sets policy mark ipdscp be.

Each port selected will be added to the policy created.

### Selection Criteria

**Traffic Type** - Traffic type is used to define the DiffServ Class. Traffic type options: VOIP, HTTP, FTP, Telnet, and Any.



**Ports to Include in Config** - List the ports which can be configured to support a DiffServ policy. The DiffServ policy will be added to selected ports.

**Policing** - Enabling policing will add policing to the DiffServ Policy and the policing rate will be applied.

**Committed Rate** - When Policing is enabled, the committed rate will be applied to the policy and the policing action is set to conform. When Policing is disabled, the committed rate is not applied and the policy is set to markdscp.

**Outbound Priority** - When Policing is enabled, Outbound Priority defines the type of policing conform action where: High sets action to markdscp ef, Med sets action to markdscp af31, and Low sets action to send. When Policing is disabled, Outbound Priority defines the policy where: High sets policy to mark ipdscp ef, Med sets policy to mark ipdscp af31, Low set policy to mark ipdscp be.

DiffServ Wizard

 Print
  Reload
  Help

---

Traffic Type	<input type="text" value="VOIP"/>	
Ports to Include in Config	<input type="text" value="0/1"/> <input type="text" value="0/2"/> <input type="text" value="0/3"/> <input type="text" value="0/4"/> <input type="text" value="0/5"/> <input type="text" value="0/6"/> <input type="text" value="0/7"/> <input type="text" value="0/8"/> <input type="text" value="0/9"/> <input type="text" value="0/10"/>	
Policing	<input type="text" value="YES"/>	
Committed Rate	<input type="text" value="1"/> (1 - 4294967295)Kbps	
Outbound Priority	<input type="text" value="High"/>	
<input type="button" value="Submit"/>		

## 11.2.6.4 Managing Class of Service

### 11.2.6.4.1. Configuring Trust Mode Configuration Page

#### Selection Criteria

**Slot/Port** - Specifies all CoS configurable interfaces. The option "Global" represents the most recent global configuration settings. These may be overridden on a per-interface basis.

#### Configurable Data

**Interface Trust Mode** - Specifies whether or not to trust a particular packet marking at ingress.

Interface Trust Mode can only be one of the following:

- *untrusted*
- *trust dot1p*
- *trust ip-dscp*

Default value is trust dot1p.

#### Non-Configurable Data

**Untrusted Traffic Class** - Displays traffic class (i.e. queue) to which all traffic is directed when in 'untrusted' mode. Valid Range is (0 to 7).

**Non-IP Traffic Class** - Displays traffic class (i.e. queue) to which all non-IP traffic is directed when in 'trust ip-precedence' or 'trust ip-dscp' mode. Valid Range is (0 to 7).

**Current 802.1p Priority Mapping** - Displays the current 802.1p priority mapping configuration.

**Command Buttons**

**Submit** - Send the updated configuration to the switch. Configuration changes take effect immediately. These changes will not be retained across a power cycle unless a save is performed.

**Restore Defaults** - Restores default settings.

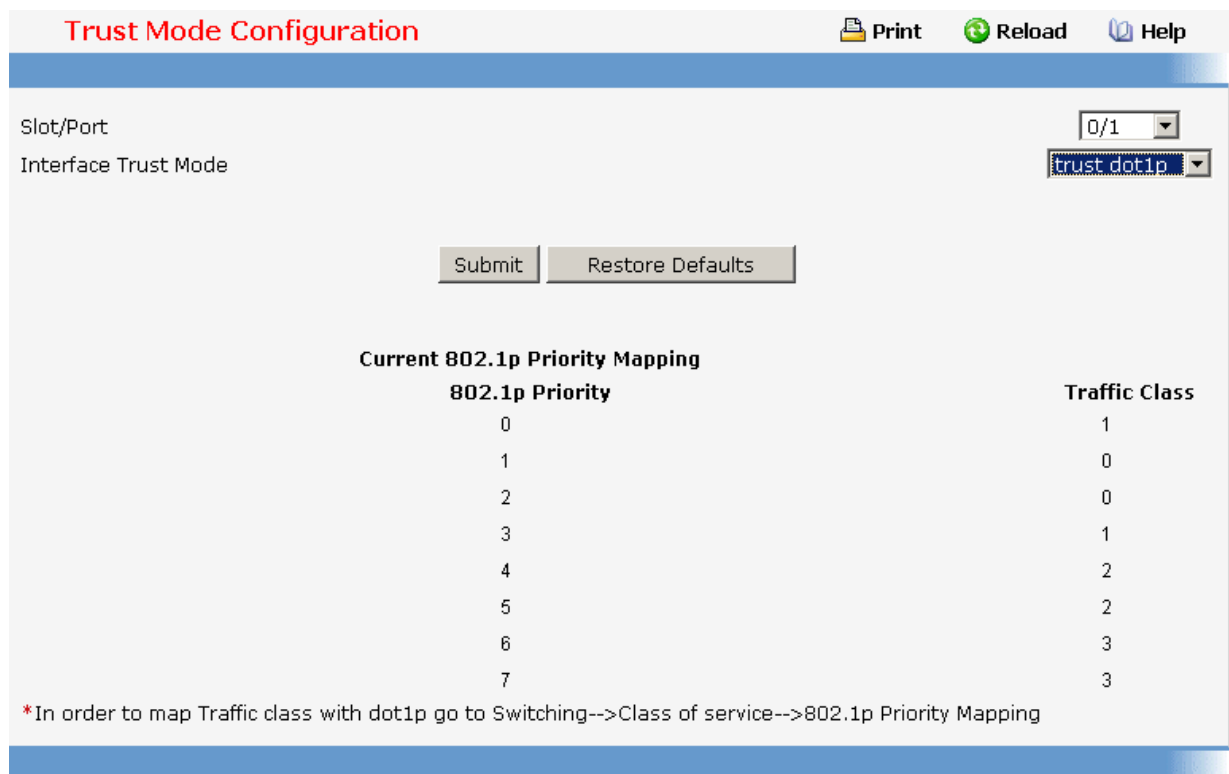

The screenshot shows the 'Trust Mode Configuration' page. At the top, there are 'Print', 'Reload', and 'Help' icons. Below the title bar, there are dropdown menus for 'Slot/Port' (set to 0/1) and 'Interface Trust Mode' (set to trust dot1p). Two buttons, 'Submit' and 'Restore Defaults', are visible. The main content is a table titled 'Current 802.1p Priority Mapping' with two columns: '802.1p Priority' and 'Traffic Class'.

802.1p Priority	Traffic Class
0	1
1	0
2	0
3	1
4	2
5	2
6	3
7	3

\*In order to map Traffic class with dot1p go to Switching-->Class of service-->802.1p Priority Mapping

**11.2.6.4.2. Managing DSCP Mapping Configuration Page**

**Selection Criteria**

**Slot/Port** - Specifies all CoS configurable interfaces. The option "Global" represents the most recent global configuration settings.

**Configurable Data**



**IP DSCP Value Traffic Class** - Specify which internal traffic class to map the corresponding IP DSCP value. Valid Range is (0 to 7) .

**Command Buttons**

**Submit** - Send the updated configuration to the switch. Configuration changes take effect immediately. These changes will not be retained across a power cycle unless a save is performed.

**Restore Defaults** - Restores default settings.

IP DSCP Mapping Configuration

 **Print**
 **Reload**
 **Help**

Slot/Port	Global <span style="font-size: small;">▼</span>
IP DSCP Value	Traffic Class
0	1 <span style="font-size: small;">▼</span>
1	1 <span style="font-size: small;">▼</span>
2	1 <span style="font-size: small;">▼</span>
3	1 <span style="font-size: small;">▼</span>
4	1 <span style="font-size: small;">▼</span>
5	1 <span style="font-size: small;">▼</span>
6	1 <span style="font-size: small;">▼</span>
7	1 <span style="font-size: small;">▼</span>
8	0 <span style="font-size: small;">▼</span>
9	0 <span style="font-size: small;">▼</span>
10	0 <span style="font-size: small;">▼</span>
11	0 <span style="font-size: small;">▼</span>
12	0 <span style="font-size: small;">▼</span>
13	0 <span style="font-size: small;">▼</span>
14	0 <span style="font-size: small;">▼</span>
15	0 <span style="font-size: small;">▼</span>

### 11.2.6.4.3. Configuring CoS interface

#### Selection Criteria

**Slot/Port** - Specifies all CoS configurable interfaces. The option "Global" represents the most recent global configuration settings. These may be overridden on a per-interface basis.

#### Configurable Data



**Interface Shaping Rate** - Specifies the maximum bandwidth allowed, typically used to shape the outbound transmission rate. This value is controlled independently of any per-queue maximum bandwidth configuration. It is effectively a second-level shaping mechanism. Default value is 0. Valid Range is (0 to 100) in increments of 5 . The value 0 means maximum is unlimited.

#### Command Buttons

**Restore Defaults** - Restores default settings.

**Submit** - Send the updated configuration to the switch. Configuration changes take effect immediately. These changes will not be retained across a power cycle unless a save is performed.

CoS Interface Configuration

 **Print**
 **Reload**
 **Help**

Slot/Port

Interface Shaping Rate  (0 to 100 in increments of 5)

#### 11.2.6.4.4. Configuring CoS interface queue

##### Selection Criteria

**Slot/Port** - Specifies all CoS configurable interfaces. The option "Global" represents the most recent global configuration settings. These may be overridden on a per-interface basis.

**Queue ID** - Specifies all the available queues per interface(platform based).

**Scheduler Type** - Specifies the type of scheduling used for this queue. Scheduler Type can only be one of the following:

- ***strict***
- ***weighted***

Default value is weighted.

**Queue Management Type** - Queue depth management technique used for queues on this interface. This is only used if device supports independent settings per-queue. Queue Management Type can only be:

- ***taildrop***

Default value is taildrop.

##### Configurable Data

**Minimum Bandwidth** - Specifies the minimum guaranteed bandwidth allotted to this queue. Setting this value higher than its corresponding Maximum Bandwidth automatically increases the maximum to the same value. Default value is 0. Valid Range is (0 to 100) in increments of 5 . The value 0 means no guaranteed minimum. Sum of individual Minimum Bandwidth values for all queues in the selected interface cannot exceed defined maximum (100).

### Configurable Data

**Minimum Bandwidth Allocated** - Specifies the sum of individual Minimum Bandwidth values for all queues in the interface. The sum cannot exceed the defined maximum (100). This value is considered while configuring the Minimum Bandwidth for a queue in the selected interface.

### Command Buttons

**Restore Defaults for All Queues** - Restores default settings for all queues on the selected interface.

**Submit** - Send the updated configuration to the switch. Configuration changes take effect immediately. These changes will not be retained across a power cycle unless a save is performed.

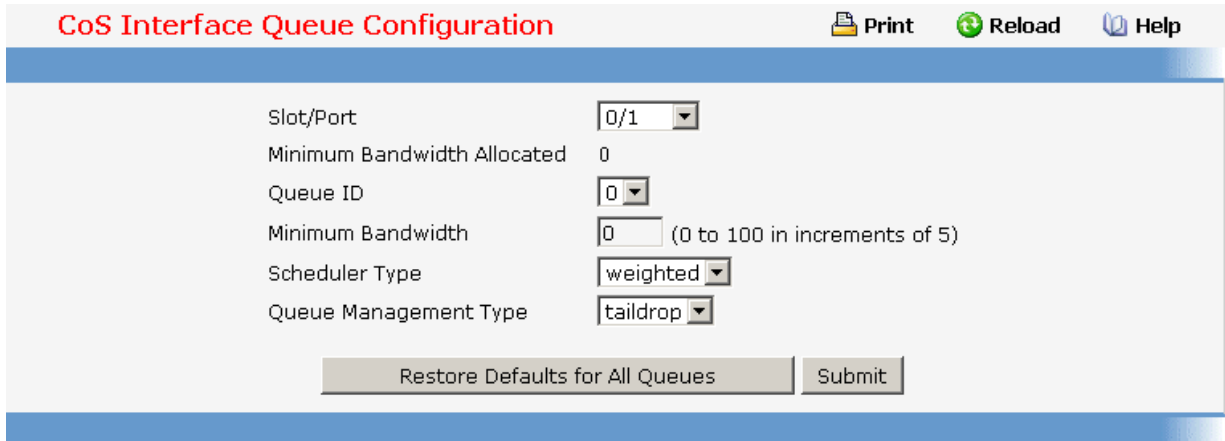

#### 11.2.6.4.5. Viewing CoS interface queue status

##### Selection Criteria

**Slot/Port** - Specifies all CoS configurable interfaces. The option "Global" represents the most recent global configuration settings. These may be overridden on a per-interface basis.

##### Non-Configurable Data

**Queue ID** - Specifies the queueID.

**Minimum Bandwidth** - Specifies the minimum guaranteed bandwidth allotted to this queue. The value 0 means no guaranteed minimum. Sum of individual Minimum Bandwidth values for all queues in the selected interface cannot exceed defined maximum (100).





**Scheduler Type** - Specifies the type of scheduling used for this queue. Scheduler Type can only be one of the following:

- ***strict***
- ***weighted***

**Queue Management Type** - Queue depth management technique used for queues on this interface. This is only used if device supports independent settings per-queue. Queue Management Type can only be one of the following:

- ***taildrop***

CoS Interface Queue Status				
 Print  Reload  Help				
Slot/Port <span style="float: right;">0/1</span>				
Queue ID	Minimum Bandwidth	Scheduler Type	Queue Management Type	
0	0	weighted	taildrop	
1	0	weighted	taildrop	
2	0	weighted	taildrop	
3	0	weighted	taildrop	
4	0	weighted	taildrop	
5	0	weighted	taildrop	
6	0	weighted	taildrop	
7	0	weighted	taildrop	

## 11.2.7 IP Multicast Menu

### 11.2.7.1 Managing DVMRP Protocol

#### 11.2.7.1.1. Configuring DVMRP Global Configuration Page

#### Configurable Data

**Admin Mode** - Select enable or disable from the dropdown menu. This sets the administrative status of DVMRP to active or inactive. The default is disable.

#### Non-Configurable Data

**Version** - The current value of the DVMRP version string.

**Total Number of Routes** - The number of routes in the DVMRP routing table.

**Reachable Routes** - The number of routes in the DVMRP routing table that have a non-infinite metric.

### Command Buttons

**Submit** - Send the updated configuration to the switch. Configuration changes take effect immediately. These changes will not be retained across a power cycle unless a save is performed.

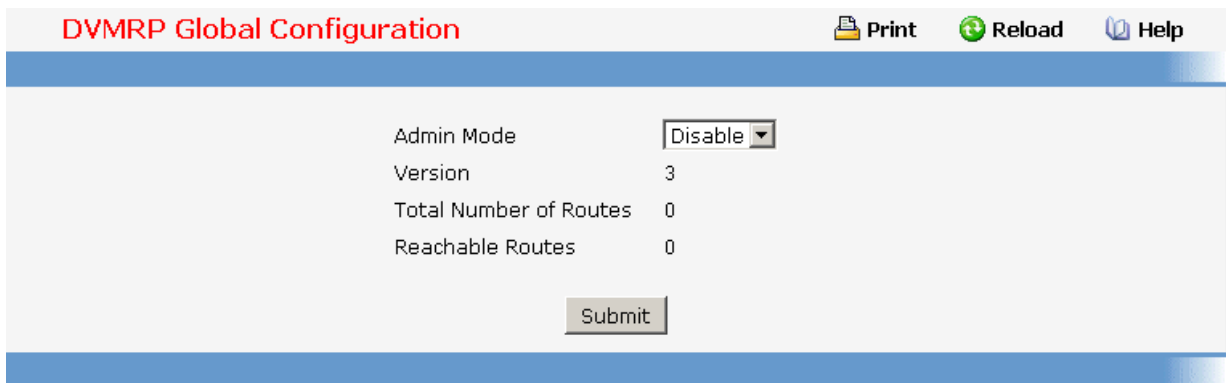

DVMRP Global Configuration	
Admin Mode	Disable
Version	3
Total Number of Routes	0
Reachable Routes	0
<input type="button" value="Submit"/>	

### 11.2.7.1.2. Configuring DVMRP Interface Configuration Page

#### Selection Criteria

**Slot/Port** - Select the interface for which data is to be configured. You must configure at least one router interface before you configure a DVMRP interface. Otherwise you will see a message telling you that no router interfaces are available, and the configuration screen will not be displayed.

#### Configurable Data



**Interface Mode** - Select enable or disable from the pull-down menu to set the administrative mode of the selected DVMRP routing interface.

**Interface Metric** - Enter the DVMRP metric for the selected interface. This value is sent in DVMRP messages as the cost to reach this network. Valid values are from (1 to 31).

#### Command Buttons

**Submit** - Send the updated configuration to the switch. Configuration changes take effect immediately. These changes will not be retained across a power cycle unless a save is performed.

DVMRP Interface Configuration

 Print
  Reload
  Help

Slot/Port

Interface Mode

Interface Metric  (1 to 31)

### 11.2.7.1.3. Viewing DVMRP Configuration Summary

#### Selection Criteria

- **Slot/Port** - Select the interface for which data is to be displayed. You must configure at least one router interface before you can display data for a DVMRP interface. Otherwise you will see a message telling you that no router interfaces are available, and the configuration summary screen will not be displayed.

#### Non-Configurable Data

**Interface Mode** - The administrative mode of the selected DVMRP routing interface, either enable or disable.

**Protocol State** - The operational state of the DVMRP protocol on the selected interface, either operational or non-operational.

**Local Address** - The IP address used as a source address in packets sent from the selected interface.

**Interface Metric** - The metric used to calculate distance vectors for the selected interface.

**Generation ID** - The DVMRP generation ID used by the router for the selected interface. This value is reset every time an interface is (re)started and is placed in prune messages. A change in generation ID informs the neighbor routers that any previous information about this router should be discarded.

**Received Bad Packets** - The number of invalid packets received on the selected interface.

**Received Bad Routes** - The number of invalid routes received on the selected interface.

**Sent Routes** - The number of routes sent on the selected interface.

**Neighbor IP** - The IP address of the neighbor whose information is displayed.

**State** - The state of the specified neighbor router on the selected interface, either active or down.

**Neighbor Uptime** - The DVMRP uptime for the specified neighbor on the selected interface. This is the time since the neighbor entry was learned.

**Neighbor Expiry Time** - The DVMRP expiry time for the specified neighbor on the selected interface. This is the time left before this neighbor entry will age out, and is not applicable if the neighbor router's state is down.

**Generation ID** - The DVMRP generation ID for the specified neighbor on the selected interface.

**Major Version** - The DVMRP Major Version for the specified neighbor on the selected interface.

**Minor Version** - The DVMRP Minor Version for the specified neighbor on the selected interface.

**Capabilities** - The DVMRP capabilities of the specified neighbor on the selected interface.

**Received Routes** - The number of routes received for the specified neighbor on the selected interface.

**Received Bad Packets** - The number of invalid packets received for the specified neighbor on the selected interface.

**Received Bad Routes** - The number of invalid routes received for the specified neighbor on the selected interface.

### Command Buttons

**Refresh** - Refresh the screen with the new data.

Slot/Port	0/1
<b>Interface Parameters</b>	
Interface Mode	Enable
Protocol State	Operational
Local Address	192.168.101.5
Interface Metric	1
<b>Interface Statistics</b>	
Generation ID	65627
Received Bad Packets	0
Received Bad Routes	0
Sent Routes	0
<b>Neighbor Parameters</b>	
Neighbor IP	192.168.101.3
State	Active
Up Time (secs)	31
Expiry Time (secs)	29
Generation ID	94970
Major Version	3
Minor Version	255
Capabilities	Prune GenID Mtrace
Received Routes	0
Received Bad Packets	0
Received Bad Routes	0

#### 11.2.7.1.4. Viewing DVMRP Next Hop Configuration Summary

##### Non-Configurable Data

**Source IP** - The IP address used with the source mask to identify the source network for this table entry.

**Source Mask** - The network mask used with the source IP address.

**Next Hop Interface** - The outgoing interface for this next hop.

**Type** - The next hop type. 'Leaf' means that no downstream dependent neighbors exist on the outgoing interface. Otherwise, the type is 'branch'.

##### Command Buttons

**Refresh** - Refresh the screen with the new data

DVMRP Next Hop Summary			
Source IP	Source Mask	Next Hop Interface	Type
192.168.101.0	255.255.255.0	0/1	Leaf

Refresh

### 11.2.7.1.5. Viewing DVMRP Prune Summary

#### Non-Configurable Data

**Group IP** - The group address which has been pruned.

**Source IP** - The address of the source or source network which has been pruned.

**Source Mask** - The subnet mask to be combined with the source IP address to identify the source or source network which has been pruned.

**Expiry Time (secs)** - The amount of time remaining before this prune should expire at the upstream neighbor. If no prune messages have been received from downstream neighbors, this is set to value of the default prune lifetime timer, otherwise it is set to the smallest received value or the default timer, whichever is less.

#### Command Buttons

**Refresh** - Refresh the screen with the new data

DVMRP Prune Summary			
Group IP	Source IP	Source Mask	Expiry Time (secs)

Refresh

### 11.2.7.1.6. Viewing DVMRP Route Summary

#### Non-Configurable Data

**Source Address** - The network address that is combined with the source mask to identify the sources for this entry.

**Source Mask** - The subnet mask to be combined with the source address to identify the sources for this entry.

**Upstream Neighbor** - The address of the upstream neighbor (e.g., RPF neighbor) from which IP datagrams from these sources are received.

**Interface** - The interface on which IP datagrams sent by these sources are received. A value of 0 typically means the route is an aggregate for which no next-hop interface exists.

**Metric** - The distance in hops to the source subnet.

**Expiry Time (secs)**- The minimum amount of time remaining before this entry will be aged out.

**Up Time (secs)**- The time since the route represented by this entry was learned by the router.

### Command Buttons

**Refresh** - Refresh the screen with the new data

DVMRP Route Summary							Print	Reload	Help
Source Address	Source Mask	Upstream Neighbor	Interface	Metric	Expiry Time (secs)	Up Time (secs)			
192.168.101.0	255.255.255.0	0.0.0.0	0/1	0	0	218			
Refresh									

## 11.2.7.2 Managing IGMP Protocol

### 11.2.7.2.1. Configuring IGMP Global Configuration Page

#### Configurable Data

**Admin Mode** - Select enable or disable from the pulldown menu to set the administrative status of IGMP in the router to active or inactive. The default is disable.

#### Command Buttons

**Submit** - Send the updated configuration to the router. Configuration changes take effect

immediately. These changes will not be retained across a power cycle unless a save is performed.

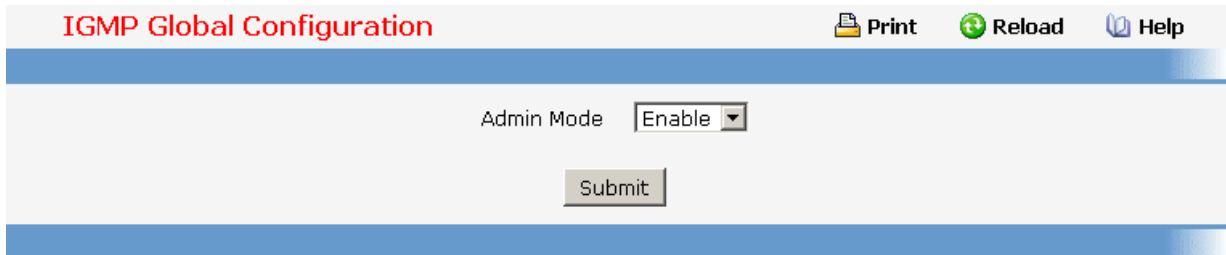

#### 11.2.7.2.2. Configuring IGMP Interface Configuration Page

##### Selection Criteria

**Slot/Port** - Select the slot and port for which data is to be displayed or configured from the pulldown menu. Slot 0 is the base unit. You must have configured at least one router interface before configuring or displaying data for an IGMP interface, otherwise an error message will be displayed.

##### Configurable Data

**Interface Mode** - Select enable or disable from the pulldown menu to set the administrative status of IGMP on the selected interface. The default is disable.

**Version** - Enter the version of IGMP you want to configure on the selected interface. Valid values are 1 to 3 and the default value is 3.

**Robustness** - Enter the robustness value. This variable allows tuning for the expected packet loss on a subnet. If you expect the subnet to be lossy, you should enter a higher number for this parameter. IGMP is robust to (robustness variable-1) packet losses. Valid values are from 1 to 255. The default value is 2.

**Query Interval** - Enter the frequency in seconds at which IGMP host-query packets are to be transmitted on this interface. Valid values are from 1 to 3600. The default value is 125.

**Query Max Response Time** - Enter the maximum query response time to be advertised in IGMPv2 queries on this interface, in tenths of a second. The default value is 100. Valid values are from (0 to 255) .

**Startup Query Interval** - Enter the number of seconds between the transmission of startup queries on the selected interface. The valid values are from 1 to 300. The default value is 31.

**Startup Query Count** - Enter the number of queries to be sent on startup. The valid values



are from 1 to 20. The default value is 2.



**Last Member Query Interval** - Enter the last member query interval in tenths of a second. This the maximum response time to be inserted into group-specific queries sent in response to leave group messages, and is also the amount of time between group-specific query messages. Valid values are from 0 to 255. The default value is 10. This value is not used for IGMP version 1.

**Last Member Query Count** - Enter the number of queries to be sent on receiving a leave group report. Valid values are from 1 to 20. The default value is 2.

### Command Buttons

**Submit** - Send the updated configuration to the router. Configuration changes take effect immediately. These changes will not be retained across a power cycle unless a save is performed.

IGMP Interface Configuration

 Print
  Reload
  Help

Slot/Port	0/1
Interface Mode	Enable
Version	3 (1 to 3)
Robustness	2 (1 to 255)
Query Interval (secs)	125 (1 to 3600)
Query Max Response Time (1/10 of a second)	100 (0 to 255)
Startup Query Interval (secs)	31 (1 to 300)
Startup Query Count	2 (1 to 20)
Last Member Query Interval (1/10 of a second)	10 (0 to 255)
Last Member Query Count	2 (1 to 20)

### 11.2.7.2.3. Viewing IGMP Configuration Summary Page

#### Selection Criteria

**Slot/Port** - Select the slot and port for which data is to be displayed. Slot 0 is the base unit.

#### Non-Configurable Data

**Interface Mode** - The administrative status of IGMP on the selected interface.

**IP Address** - The IP address of the selected interface.

**Subnet Mask** - The subnet mask for the IP address of the selected interface.

**Protocol State** - The operational state of IGMP on the selected interface.

**Version** - The version of IGMP configured on the selected interface.

**Query Interval** - The frequency at which IGMP host-query packets are transmitted on the selected interface.

**Query Max Response Time** - The maximum query response time advertised in IGMPv2 queries sent from the selected interface.

**Robustness** - The robustness parameter for the selected interface. This variable allows tuning for the expected packet loss on a subnet. If a subnet is expected to be lossy, the robustness variable may be increased. IGMP is robust to (robustness variable-1) packet losses.

**Startup Query Interval** - The interval at which startup queries are sent on the selected interface.

**Startup Query Count** - The number of queries to be sent on startup.

**Last Member Query Interval** - The last member query interval. The last member query interval is the maximum response time inserted into group-specific queries sent in response to leave group messages, and is also the amount of time between group-specific query messages. This value may be tuned to modify the leave latency of the network. A reduced value results in reduced time to detect the loss of the last member of a group. This value is not used for IGMP version 1.

**Last Member Query Count** - The number of queries to be sent on receiving a leave group report.

**Querier** - The address of the IGMP querier on the IP subnet to which the selected interface is attached.

**Querier Status** - Indicates whether the selected interface is in querier or non querier mode.

**Querier Up Time** - The time in seconds since the IGMP interface querier was last changed.

**Querier Expiry Time** - The time in seconds remaining before the other querier present timer expires. If the local system is the querier, this will be zero.

**Wrong Version Queries** - The number of queries that have been received on the selected interface with an IGMP version that does not match the IGMP version configured for the interface, over the lifetime of the entry. IGMP requires that all routers on a LAN be configured to run the same version of IGMP. Therefore, a configuration error is indicated if any queries are received with the wrong version number.

**Number of Joins** - The number of times a group membership has been added on the selected interface; that is, the number of times an entry for this interface has been added to the cache table. This gives an indication of the amount of IGMP activity on the interface.

**Number of Groups** - The current number of entries for the selected interface in the cache table.

### Command Buttons

**Refresh** - Refresh the data on the screen with the present state of the data in the router.

Slot/Port	0/1
<b>Interface Parameters</b>	
Interface Mode	Enable
IP Address	192.168.101.5
Subnet Mask	255.255.255.0
Protocol State	Operational
Version	3
Query Interval (secs)	125
Query Max Response Time (1/10 of a second)	100
Robustness	2
Startup Query Interval (secs)	31
Startup Query Count	2
Last Member Query Interval (1/10 of a second)	10
Last Member Query Count	2
<b>Interface Statistics</b>	
Querier	192.168.101.3
Querier Status	Non-Querier
Querier Up Time (secs)	3530
Querier Expiry Time (secs)	225
Wrong Version Queries	0
Number of Joins	0
Number of Groups	0
Refresh	

#### 11.2.7.2.4. Viewing IGMP Cache Information Page

##### Selection Criteria

**Slot/Port** - Select the Slot and port for which data is to be displayed. Slot 0 is the base unit.

**Multicast Group IP** - Select the IP multicast group address for which data is to be displayed. If no group membership reports have been received on the selected interface you will not be able to make this selection, and none of the non-configurable data will be displayed.

##### Non-Configurable Data

**Last Reporter** - The IP address of the source of the last membership report received for the IP Multicast group address on the selected interface.

**Up Time** - The time elapsed since this entry was created.

**Expiry Time** - The minimum amount of time remaining before this entry will be aged out.

**Version 1 Host Timer** - The time remaining until the local router will assume that there are no longer any IGMP version 1 members on the IP subnet attached to this interface. When an IGMPv1 membership report is received, this timer is reset to the group membership timer. While this timer is non-zero, the local router ignores any IGMPv2 leave messages for this group that it receives on the selected interface. This field is displayed only if the interface is configured for IGMP version 1.

**Version 2 Host Timer** - The time remaining until the local router will assume that there are no longer any IGMP version 2 members on the IP subnet attached to this interface. When an IGMPv2 membership report is received, this timer is reset to the group membership timer. While this timer is non-zero, the local router ignores any IGMPv1 and IGMPv3 leave messages for this group that it receives on the selected interface. This field is displayed only if the interface is configured for IGMP version 2.

**Compatibility** - This parameter shows group compatibility mode (v1, v2 and v3) for this group on the specified interface.

**Filter Mode** - The source filter mode (Include/Exclude/NA) for the specified group on this interface. When NA mode is active the field is blank

### Command Buttons

**Refresh** - Refresh the data on the screen with the present state of the data in the router.

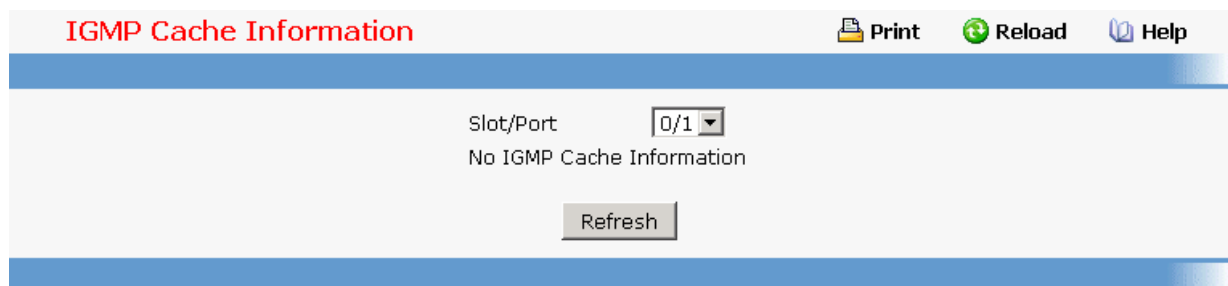

### 11.2.7.2.5. Viewing IGMP Interface Membership Details Information Page

#### Selection Criteria

**Slot/Port** - Select the Slot and port for which data is to be displayed. Slot 0 is the base unit.

**Multicast Group IP** - Select the IP multicast group address for which data is to be displayed. If no group membership reports have been received on the selected interface you will not be able to make this selection, and none of the non-configurable data will be

displayed.

### Non-Configurable Data

**Interface** - This parameter shows the interface on which multicast packets are forwarded.

**Group Compatibility Mode** - This parameter shows group compatibility mode (v1, v2 and v3) for this group on the specified interface.

**Source Filter Mode** - The source filter mode (Include/Exclude/NA) for the specified group on this interface.

**Source Hosts** - This parameter shows source addresses which are members of this multicast address.

**Expiry Time** - This parameter shows expiry time interval against each source address which are members of this multicast group. This is the amount of time after which the specified source entry is aged out.

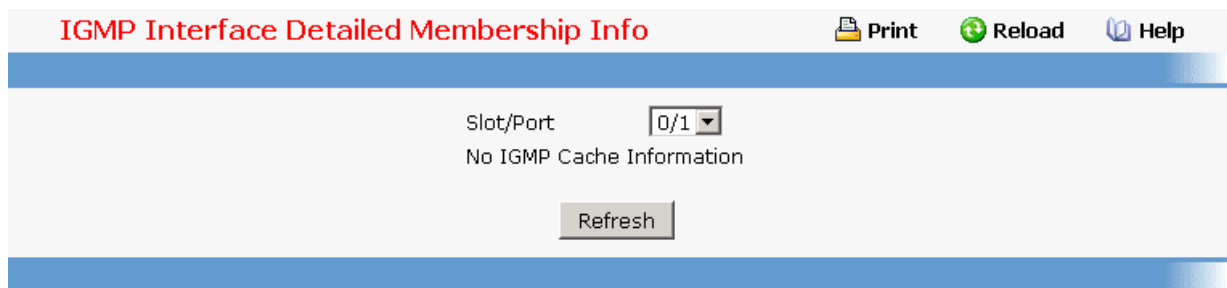

### 11.2.7.2.6. Configuring IGMP Proxy Interface Configuration Page

#### Selection Criteria

**Slot/Port** - Select the port for which data is to be displayed or configured from the pulldown menu. You must have configured at least one router interface before configuring or displaying data for an IGMP Proxy interface and it should not be a IGMP routing interface. This field is configurable only when interface mode is disabled.

#### Configurable Data

**Interface Mode** - Select enable or disable from the pulldown menu to set the administrative status of IGMP Proxy on the selected interface. The default is disable. Routing, IGMP and Multicast global admin modes should be enabled to enable IGMP Proxy interface mode.

**Version** - Enter the version of IGMP you want to configure on the selected interface. Valid values are 1 to 3 and the default value is 3. This field is configurable only when IGMP Proxy interface mode is enabled.

**Unsolicited Report Interval** - Enter the unsolicited time interval value in seconds. The Unsolicited Report Interval is the time between repetitions of a host's initial report of membership in a group. Valid values are from 1 to 260. The default value is 1.

### Command Buttons

**Submit** - Send the updated configuration to the router. Configuration changes take effect immediately. These changes will not be retained across a power cycle unless a save is performed.

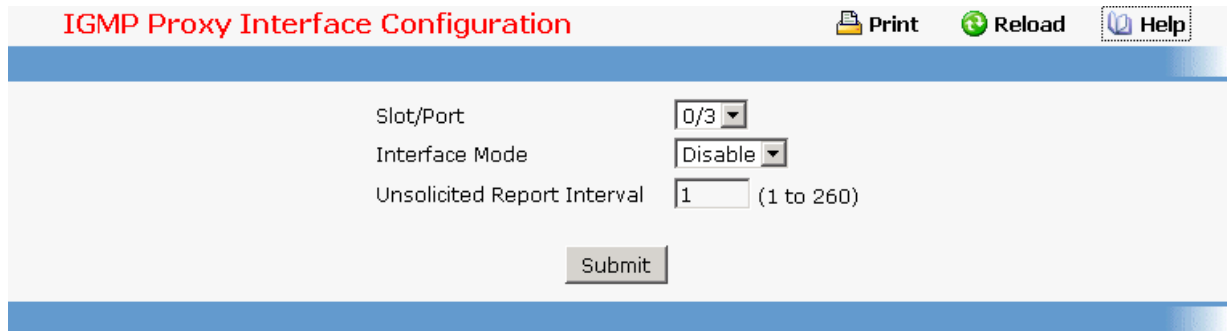

#### 11.2.7.2.7. Viewing IGMP Proxy Configuration Summary Page

##### Non-Configurable Data

**Slot/Port** - Displays the interface on which IGMP proxy is enabled.

**IP Address** - The IP address of the IGMP Proxy interface.

**Subnet Mask** - The subnet mask for the IP address of the IGMP Proxy interface.

**Admin Mode** - The administrative status of IGMP Proxy on the selected interface.

**Operational Mode** - The operational state of IGMP Proxy interface.

**Number of Groups** - The current number of multicast group entries for the IGMP Proxy interface in the cache table.

**Version** - The version of IGMP configured on the IGMP Proxy interface.

**Unsolicited Report Interval** - The Unsolicited Report Interval is the time between repetitions of a host's initial report of membership in a group. Default: 1 second. cache table.

**Version 1 Querier Timeout** - The older IGMP version 1 querier timeout value in seconds. The Older Version Querier Interval is the time-out for transitioning a host back to IGMPv3 mode once an older version query is heard. When an older version query is received, hosts set their Older Version Querier Present Timer to Older Version Querier Interval.

**Version 2 Querier Timeout** - The older IGMP version 2 querier timeout value in seconds.

**Proxy Start Frequency** - The number of times the proxy was brought up.

**Proxy Interface Statistics** - The Queries Received, Reports Received/Sent, Leaves Received/Sent are displayed in the form a table for each IGMP version.

### Command Buttons

**Refresh** - Refresh the data on the screen with the present state of the data in the router.

**Clear Statistics** - Clear the IGMP Proxy interface statistics.

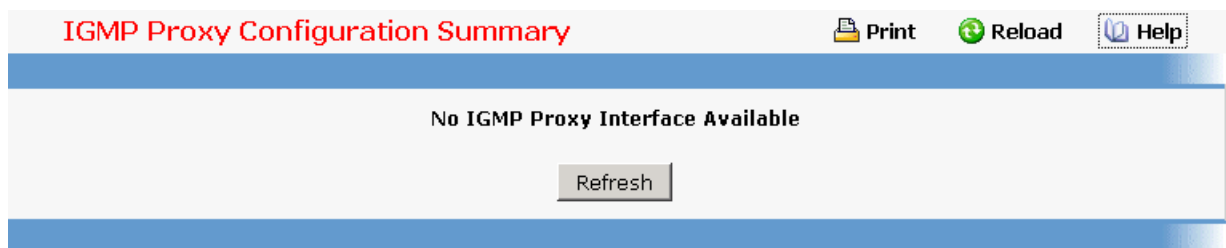

### 11.2.7.2.8. Viewing IGMP Proxy Interface Membership Information Page

#### Selection Criteria

**Multicast Group IP** - Select the IP multicast group address for which data is to be displayed. If no group membership reports have been received on the selected interface you will not be able to make this selection, and none of the non-configurable data will be displayed.

#### Non-Configurable Data

**Slot/Port** - Displays the interface on which IGMP proxy is enabled.

**Last Reporter** - The IP address of the source of the last membership report received for the IP Multicast group address on the IGMP Proxy interface.

**Uptime** - The time elapsed since this entry was created.

**State** - The state of the host entry. A Host can be in one of the state. Non-member state - does not belong to the group on the interface. Delaying member state - host belongs to the group on the interface and report timer running. The report timer is used to send out the reports. Idle member state - host belongs to the group on the interface and no report timer running.

**Number of Sources** - The number of source hosts present in the selected multicast group.

### Command Buttons

**Refresh** - Refresh the data on the screen with the present state of the data in the router.

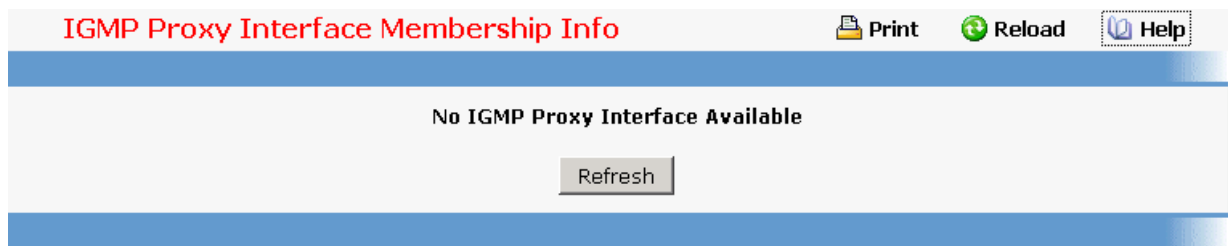

The screenshot shows a web interface titled "IGMP Proxy Interface Membership Info". At the top right, there are three icons: "Print", "Reload", and "Help". The main content area displays the message "No IGMP Proxy Interface Available" in bold black text, centered. Below this message is a single "Refresh" button.

### 11.2.7.2.9. Viewing IGMP Proxy Interface Membership Details Information Page

#### Selection Criteria

**Multicast Group IP** - Select the IP multicast group address for which data is to be displayed. If no group membership reports have been received on the IGMP Proxy interface you will not be able to make this selection, and none of the non-configurable data will be displayed.

#### Non-Configurable Data

**Slot/Port** - Displays the interface on which IGMP proxy is enabled.

**Source IP** - This parameter shows source addresses which are members of this multicast address.

**Last Reporter** - The IP address of the source of the last membership report received for the IP Multicast group address on the selected interface.

**Up Time** - Displays the up time since the entry was created in cache table.

**State** - The state of the host entry. A Host can be in one of the state. Non-member state - does not belong to the group on the interface. Delaying member state - host belongs to the group on the interface and report timer running. The report timer is used to send out the reports. Idle member state - host belongs to the group on the interface and no report timer running.

**Filter Mode** - The group filter mode (Include/Exclude/None) for the specified group on the IGMP Proxy interface.



The screenshot shows a web interface titled "IGMP Proxy Interface Membership Info Detailed". At the top right, there are three icons: "Print", "Reload", and "Help". The main content area displays the message "No IGMP Proxy Interface Available" in bold black text, centered. Below this message is a single "Refresh" button.



### 11.2.7.3 Defining Multicast Configuration

#### 11.2.7.3.1. Configuring Multicast Global Configuration Page

##### Selection Criteria

**Admin Mode** - Select enable or disable to set the administrative status of Multicast Forwarding in the router. The default is disabled.

##### Non-Configurable Data

**Protocol State** - The operational state of the multicast forwarding module.

**Table Maximum Entry Count** - The maximum number of entries in the IP Multicast routing table.

**Number Of Packets For Which Source Not Found** - The number of multicast packets that were supposed to be routed but which failed the RPF check.

**Number Of Packets For Which Group Not Found** - The number of multicast packets that were supposed to be routed but for which no multicast route was found.

**Protocol** - The multicast routing protocol presently activated on the router, if any.

**Forwarding Multicast Stream Table Entry Count** - The number of multicast route entries currently present in the Multicast route table.

**Table Highest Entry Count** - The highest number of multicast route entries that have been present in the Multicast route table.

##### Command Buttons

**Submit** - Send the updated configuration to the router. Configuration changes take effect immediately. These changes will not be retained across a power cycle unless a save is performed.

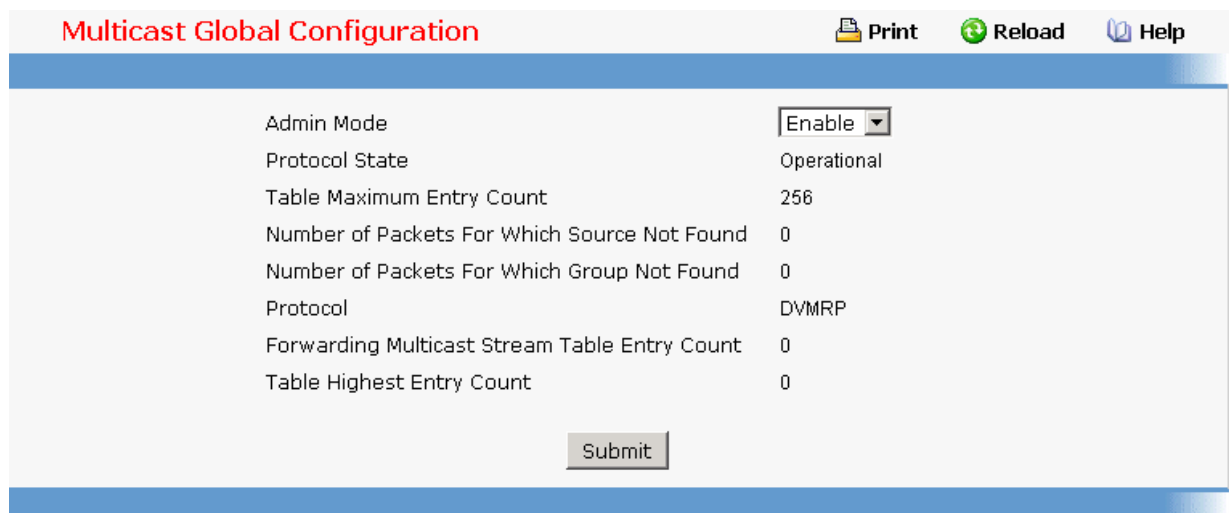

Multicast Global Configuration	
Admin Mode	Enable
Protocol State	Operational
Table Maximum Entry Count	256
Number of Packets For Which Source Not Found	0
Number of Packets For Which Group Not Found	0
Protocol	DVMRP
Forwarding Multicast Stream Table Entry Count	0
Table Highest Entry Count	0

### 11.2.7.3.2. Configuring Interface's Multicast Configuration Page

#### Selection Criteria

**Slot/Port** - Select the routing interface you want to configure from the dropdown menu.

#### Configurable Data

**TTL Threshold** - Enter the TTL threshold below which a multicast data packet will not be forwarded from the selected interface. You should enter a number between 0 and 255. If you enter 0 all multicast packets for the selected interface will be forwarded. You must configure at least one router interface before you will see this field.

#### Command Buttons

**Submit** - Send the updated configuration to the router. Configuration changes take effect immediately. These changes will not be retained across a power cycle unless a save is performed.

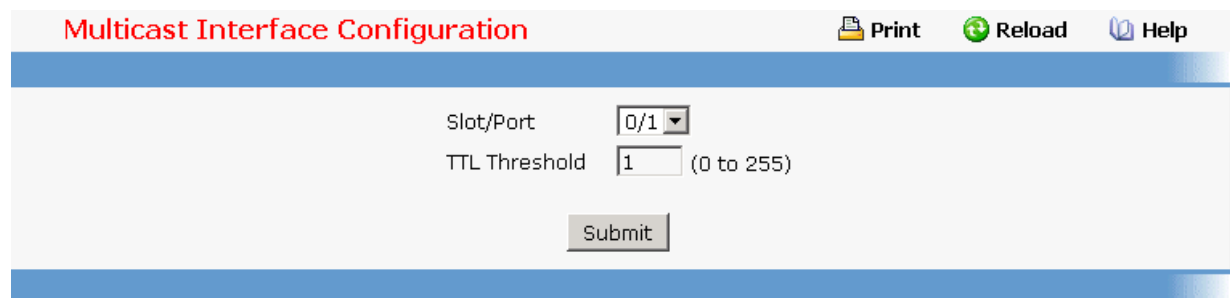

### 11.2.7.3.3. Viewing Multicast MRoute Summary Page

This screen displays selected contents of the Mroute Table in tabular form. If there are no routes in the table you will not be presented with the Selection Criteria.

#### Non-Configurable Data

**Source IP** - Enter the IP address of the multicast packet source to be combined with the Group IP to fully identify a single route whose Mroute table entry you want to display or clear. You may leave this field blank.

**Group IP** - Enter the destination group IP address whose multicast route(s) you want to display or clear.

**Incoming Interface** - The incoming interface on which multicast packets for this source/group arrive.

**Outgoing Interface(s)** - The list of outgoing interfaces on which multicast packets for this source/group are forwarded.

**Up Time (secs)**- The time in seconds since the entry was created.

**Expiry Time (secs)**- The time in seconds before this entry will age out and be removed from the table.

**RPF Neighbor** - The IP address of the Reverse Path Forwarding neighbor.

**Protocol** - The multicast routing protocol which created this entry. The possibilities are:

***PIM-DM***

**PIM-SM**
**DVMRP**

**Flags** - The value displayed in this field is valid if the multicast routing protocol running is PIMSM. The possible values are RPT or SPT. For other protocols a "-----" is displayed.

**Command Buttons**

**Refresh** - Refresh the information on the screen with the present state of the data in the router.

Multicast MRoute Summary								
Source IP	Group IP	Incoming Interface	Outgoing Interfaces	Up Time (secs)	Expiry Time (secs)	RPF Neighbor	Protocol	Flags
Refresh								

**11.2.7.3.4. Configuring Multicast Static Routes Configuration Page**
**Selection Criteria**

**Source** - Select Create Static Route to configure a new static entry in the MRoute table, or select one of the existing entries from the pulldown menu.

**Configurable Data**

**Source IP** - Enter the IP Address that identifies the multicast packet source for the entry you are creating.

**Source Mask** - Enter the subnet mask to be applied to the Source IP address.

**RPF Neighbor** - Enter the IP address of the neighbor router on the path to the source.

**Metric** - Enter the link state cost of the path to the multicast source. The range is 0 - 255 and the default is one. You can change the metric for a configured route by selecting the static route and editing this field.



**Slot/Port** - Select the interface number from the dropdown menu. This is the interface that connects to the neighbor router for the given source IP address.

**Command Buttons**

**Submit** - Send the updated configuration to the router. Configuration changes take effect immediately. These changes will not be retained across a power cycle unless a save is performed.

**Delete** - Delete the static entry with the selected Source IP address from the MRoute table.

Multicast Static Routes Configuration

 Print
  Reload
  Help

Source Create Static Route ▾

Source IP

Source Mask

RPF Neighbor

Metric  (0 to 255)

Slot/Port 0/1 ▾

### 11.2.7.3.5. Viewing Multicast Static Routes Configuration Page

#### Non-Configurable Data

**Source IP** - The IP Address that identifies the multicast packet source for this route.

**Source Mask** - The subnet mask applied to the Source IP address.

**RPF Address** - The IP address of the RPF neighbor.



**Metric** - The link state cost of the path to the multicast source. The range is 0 - 255.

**Slot/Port** - The number of the incoming interface whose IP address is used as RPF for the given source IP address.

#### Command Buttons

**Refresh** - Refresh the data on the screen with the present state of the data in the router.

Multicast Static Routes Summary

 Print
  Reload
  Help

Source IP	Source Mask	RPF Address	Metric	Slot/Port
192.168.50.1	255.255.255.0	192.168.10.2	1	0/1

### 11.2.7.3.6. Configuring Multicast Admin Boundary Configuration Page

The definition of an administratively scoped boundary is a mechanism is a way to stop the ingress and egress of multicast traffic for a given range of multicast addresses on a given routing interface.

#### Selection Criteria

**Group IP** - Select 'Create Boundary' from the pulldown menu to create a new admin scope boundary, or select one of the existing boundary specifications to display or update its configuration.

**Slot/Port** - Select the router interface for which the administratively scoped boundary is to be configured.

### Configurable Data

**Group IP** - Enter the multicast group address for the start of the range of addresses to be excluded. The address must be in the range of 239.0.0.0 through 239.255.255.255.

**Group Mask** - Enter the mask to be applied to the multicast group address. The combination of the mask and the Group IP gives the range of administratively scoped addresses for the selected interface.

### Command Buttons

**Submit** - Send the updated configuration to the router. Configuration changes take effect immediately. These changes will not be retained across a power cycle unless a save is performed.

**Delete** - Delete the selected administrative scoped boundary.

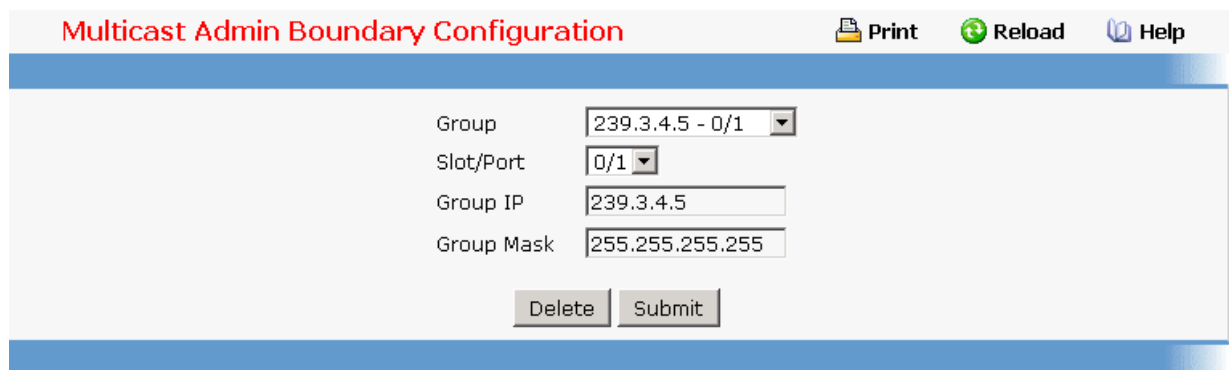

### 11.2.7.3.7. Viewing Multicast Admin Boundary Configuration Page

#### Non-Configurable Data

**Slot/Port** - The router interface to which the administratively scoped address range is applied.

**Group IP** - The multicast group address for the start of the range of addresses to be excluded.

**Group Mask** - The mask that is applied to the multicast group address. The combination of the mask and the Group IP gives the range of administratively scoped addresses for the selected interface.

#### Command Buttons

**Refresh** - Refresh the data on the screen with the present state of the data in the router.

**Multicast Admin Boundary Summary** Print Reload Help

Slot/Port	Group IP	Group Mask
0/1	239.3.4.5	255.255.255.255

Refresh

### 11.2.7.4 Configuring Multicast Mdebug

#### 11.2.7.4.1. Configuring Mrinfo Run Page

Use this screen to initiate an *mrinfo* command. You can use the *mrinfo* command to find out information about neighboring multicast routers. While you initiate the query using this screen, the results are displayed on the Mrinfo Show screen.

#### Configurable Data

**Router Interface** - Enter the IP address of the router interface for which you want to see the neighbor router information. If you do not enter an address the router will query itself.

#### Command Buttons

**Submit** - Initiate the *mrinfo* command on the router. If the *mrinfo* command completes successfully the browser will display the Mrinfo Show screen. If the *mrinfo* command fails, you will see the Mrinfo Run screen again.

**Mrinfo Run** Print Reload Help

Router Interface

Submit

#### 11.2.7.4.2. Viewing Mrinfo Summary Page

This screen displays the results of an *mrinfo* command.

#### Non-Configurable Data

**Router Interface** - The IP address of the router interface for which configuration information was requested.

**Neighboring** - The IP address of the neighboring router.

**Metric** - The routing metric for this router.

**TTL** - The time-to-live threshold on this hop.

**Flags** - The flags indicating whether the router is an IGMP querier or whether or not it has

neighbors (leaf router).

### Command Buttons

**New Mrinfo** - Redirect the web browser to the Mrinfo Run screen so that you can initiate another *mrinfo* command.

**Refresh** - Refresh the content of the screen with the latest data available on the router. Typically, it takes around 20 seconds to process the results after you have initiated the *mrinfo* command. The contents of the screen have to be refreshed to display the latest results.

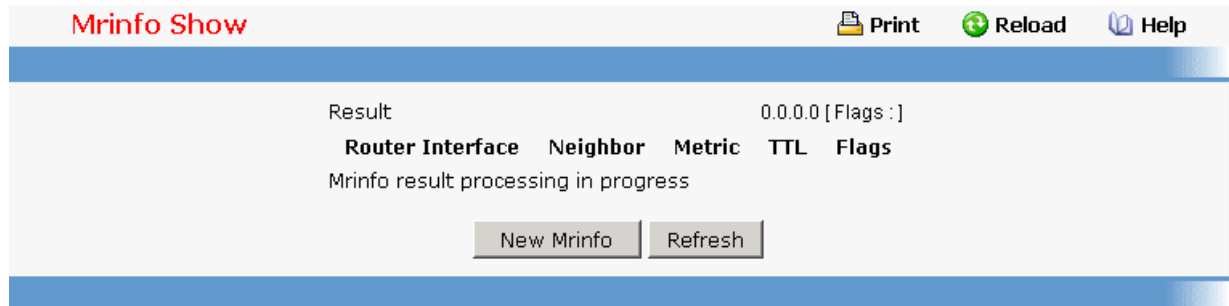

### 11.2.7.4.3. Configuring Mstat Run Page

Use this screen to initiate an *mstat* command on the router. You can use the *mstat* command to see the hop-by-hop path taken by packets from a given multicast source to the destination. It also gives you information regarding packet rate and packet loss on the path.

#### Configurable Data

**Source IP** - Enter the IP address of the multicast-capable source. This is the unicast address of the beginning of the path to be traced.

**Receiver IP** - Enter the IP address of the host to which the *mstat* response will be sent by the last hop router. If a value is not entered, the IP address of the router interface through which the *mstat* will be sent is used.

**Group IP** - Enter the multicast address of the group to be traced. If you leave this field blank, the multicast address 224.2.0.1 will be used. Valid addresses are 224.0.0.0 through 239.255.255.255.

#### Command Buttons

**Submit** - Initiate the *mstat* command on the router. If the *mstat* command completes successfully the browser will display the Mstat Show screen. If the *mstat* command fails, you will see the Mstat Run screen again.



#### 11.2.7.4.4. Viewing Mstat Summary Page

This screen is used to display the results of an *mstat* command.

##### Non-Configurable Data

This screen shows the path taken by multicast traffic between the specified IP addresses. Forward data flow is indicated by arrows pointing downward and the query path is indicated by arrows pointing upward. For each hop, both the entry and exit addresses of the router are shown if different, along with the initial TTL required for packets to be forwarded at this hop and the propagation delay across the hop. The right half of the screen displays statistics for the path in two groups. Within each group, the columns are the number of packets lost, the number of packets sent, the percentage lost, and the average packet rate at each hop. These statistics are calculated from differences between traces and from hop to hop. The first group shows the statistics for all traffic flowing out the interface at one hop and in the interface at the next hop. The second group shows the statistics only for traffic forwarded from the specified source to the specified group.

##### Command Buttons

**New Mstat** - Redirect the web browser to the Mstat Run screen so that you can initiate another *mstat* command.

**Refresh** - Refresh the content of the screen with the latest data available on the router. Typically, it takes around 20 seconds to process the results after initiating *mstat* command. You must refresh the screen to display the latest results.

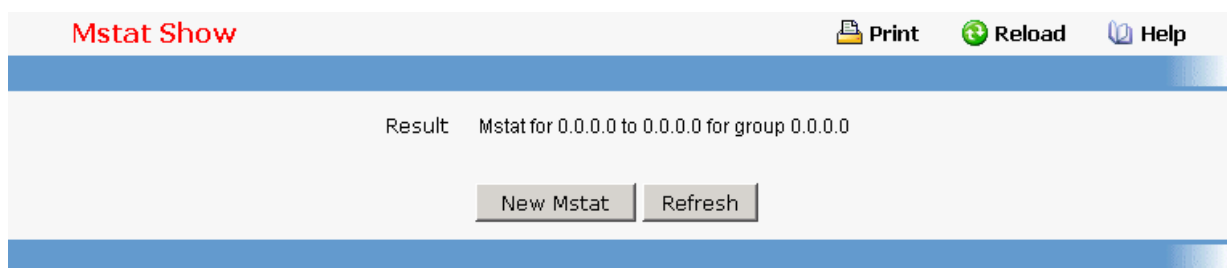

#### 11.2.7.4.5. Defining Mtrace Admin Configuration Page

##### Configurable Data

**Admin Mode** - Select enable or disable from the pulldown menu. If you select enable the



router will process and forward *mtrace* requests received from other routers, otherwise received *mtrace* requests will be discarded. This field is non-configurable for read-only users.

### Command Buttons

**Submit** - Send the updated configuration to the router. Configuration changes take effect immediately. These changes will not be retained across a power cycle unless a save is performed.

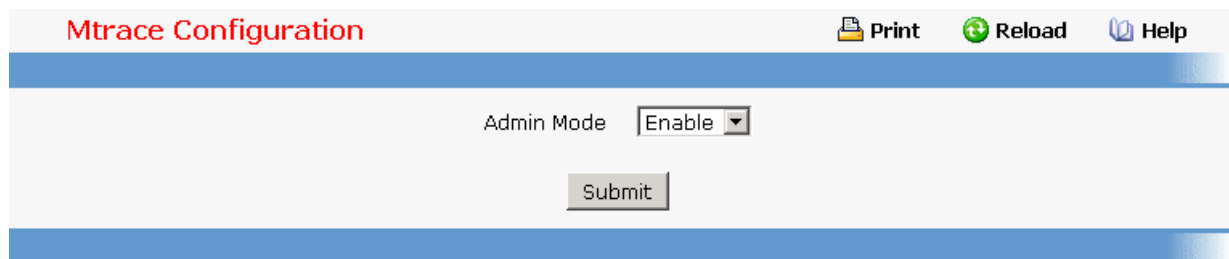

#### 11.2.7.4.6. Configuring Mtrace Run Page

Use this screen to initiate an *mtrace* command on the router. You can use the *mtrace* command trace the path from the source to a destination branch for a multicast distribution tree.

### Configurable Data

**Source IP** - Enter the IP address of a multicast-capable source. This is the unicast address of the beginning of the path to be traced.

**Receiver IP** - Enter the IP address of the host to which the *mtrace* response will be sent by the last hop router. If you leave this field blank, *mtrace* will use the IP address of the router interface through which the *mtrace* will be sent.

**Group IP** - Enter the Multicast address of the group to be traced. If you do not enter a valid address, multicast address 224.2.0.1 will be used. Valid addresses are 224.0.0.0 through 239.255.255.255.

### Command Buttons

**Submit** - Initiate the *mtrace* command on the router. If the *mtrace* command completes successfully the browser will display the Mtrace Show screen. If the *mtrace* command fails, you will see the Mtrace Run screen again.

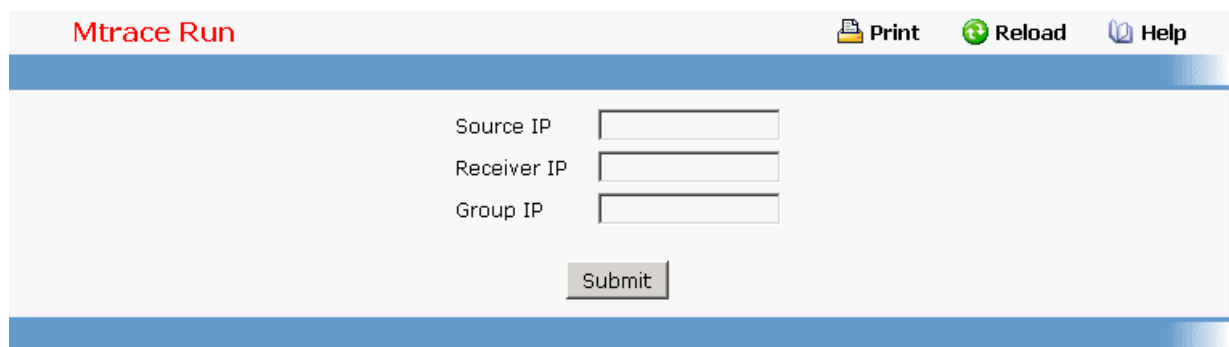

### 11.2.7.4.7. Viewing Mtrace Summary Page

This screen displays the results of an *mtrace* command. The *mtrace* command is used to trace the path from source to a destination branch for a multicast distribution tree.

#### Non-Configurable Data

**Number of hops away from destination** - The number of hops away from the destination.

**IP address of intermediate router** - The IP address of the intermediate router in the path being traced between source and destination for the hop number in the previous field.

**Multicast Protocol in use** - The multicast protocol in use on this hop.

**TTL Threshold** - The time-to-live threshold on this hop.

**Time taken to forward between hops(millsecs)** - The time taken for the trace request to be forwarded from the previous hop to this hop.

#### Command Buttons

**New Mtrace** - Redirect the web browser to the Mtrace Run screen so that you can initiate another *mtrace* command.

**Refresh** - Refresh the content of the screen with the latest data available on the router. Typically, it takes around 20 seconds to process the results after initiating *mtrace* command. You must refresh the screen to display the latest results.

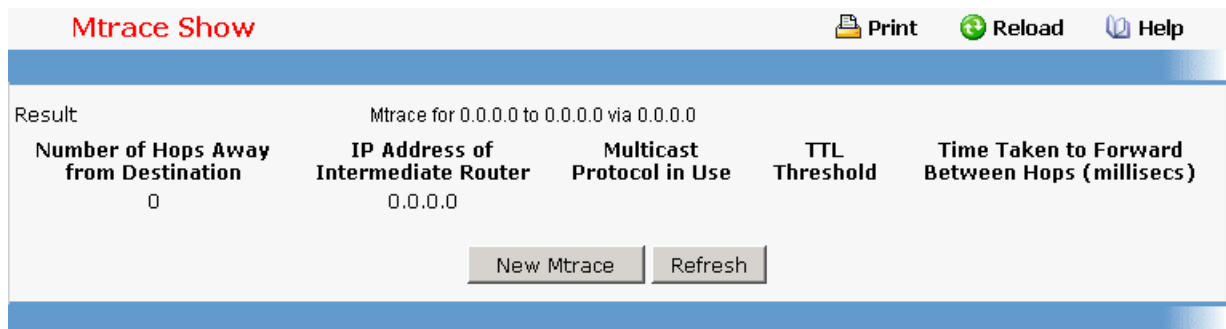

**Mtrace Show** Print Reload Help

Result: Mtrace for 0.0.0.0 to 0.0.0.0 via 0.0.0.0

Number of Hops Away from Destination	IP Address of Intermediate Router	Multicast Protocol in Use	TTL Threshold	Time Taken to Forward Between Hops (millsecs)
0	0.0.0.0			

### 11.2.7.5 Managing PIM-DM Protocol

#### 11.2.7.5.1. Configuring PIM-DM Global Admin Configuration Page

##### Configurable Data

**Admin Mode** - Select enable or disable from the pulldown menu to set the administrative status of PIM-DM in the router. The default is disabled.

##### Command Buttons

**Submit** - Send the updated configuration to the router. Configuration changes take effect immediately. These changes will not be retained across a power cycle unless a save is performed.

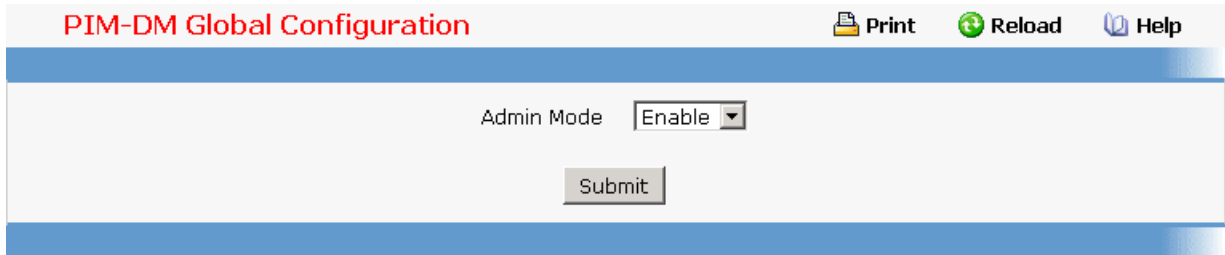

**PIM-DM Global Configuration** Print Reload Help

Admin Mode

### 11.2.7.5.2. Configuring Interface's PIM-DM Configuration Page

#### Selection Criteria

**Slot/Port** - Select the Slot and port for which data is to be displayed or configured. Slot 0 is the base unit. You must have configured at least one router interface before configuring or displaying data for a PIM-DM interface, otherwise an error message will be displayed.

#### Configurable Data

**Interface Mode** - Select enable or disable from the pulldown menu to set the administrative status of PIM-DM for the selected interface. The default is disabled.

**Hello Interval** - Enter the number of seconds between PIM hello messages transmitted from the selected interface. The default value is 30. Valid values are from (10 to 3600).

#### Command Buttons

**Submit** - Send the updated configuration to the router. Configuration changes take effect immediately. These changes will not be retained across a power cycle unless a save is performed.

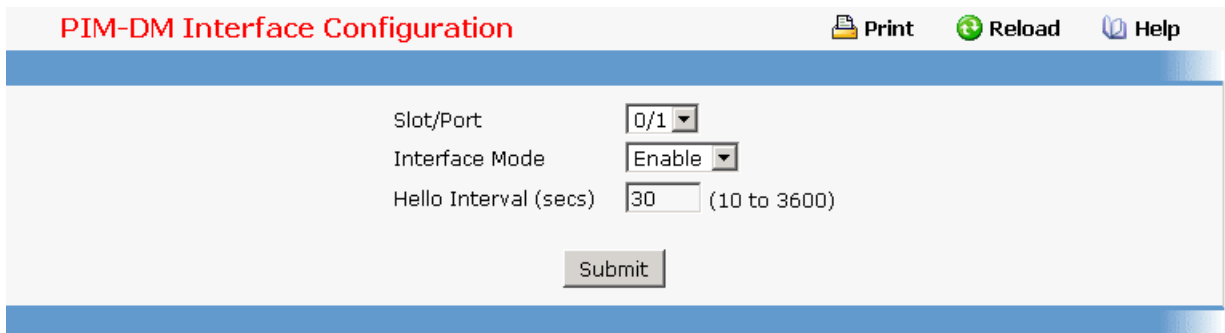

**PIM-DM Interface Configuration** Print Reload Help

Slot/Port

Interface Mode

Hello Interval (secs)  (10 to 3600)

### 11.2.7.5.3. Viewing Interface's PIM-DM Configuration Page

#### Selection Criteria

**Slot/Port** - Select the physical interface for which data is to be displayed. There must be configured at least one router interface before displaying data for a PIM-DM interface, otherwise a message will be displayed.

#### Non-Configurable Data

**Interface Mode** - Displays the administrative status of PIM-DM for the selected interface. The default is disabled.

**Protocol State** - The operational state of the PIM-DM protocol on this interface.

**Hello Interval (secs)**- The frequency at which PIM hello messages are transmitted on the selected interface.

**IP Address** - The IP address of the selected interface.

**Neighbor Count** - The number of PIM neighbors on the selected interface.

**Designated Router** - The designated router on the selected PIM interface. For point-to-point interfaces, this will be 0.0.0.0.

**Neighbor IP** - The IP address of the PIM neighbor for which this entry contains information.



**Uptime** - The time since this PIM neighbor (last) became a neighbor of the local router.

**Expiry Time** - The minimum time remaining before this PIM neighbor will be aged out.

### Command Buttons

**Refresh** - Refresh the data on the screen with the present state of the data in the router.

PIM-DM Interface Summary

 Print
  Reload
  Help

Slot/Port 0/1 ▾

**Interface Parameters**

Interface Mode	Enable
Protocol State	Operational
Hello Interval (secs)	30
IP Address	192.168.101.5

**Interface Statistics**

Neighbor Count	1
Designated Router	192.168.101.5

**Interface Neighbors**

Neighbor IP	Up Time (hh:mm:ss)	Expiry Time (hh:mm:ss)
192.168.101.3	00:00:26	00:01:19

### 11.2.7.6 Managing PIM-SM Protocol

#### 11.2.7.6.1. Configuring PIM-SM Global Configuration Page

##### Configurable Data

**Admin Mode** - Select enable or disable from the pulldown menu to set the administrative status of PIM-SM in the router. You must enable IGMP before enabling PIM-SM. The default is disabled.

**Join/Prune Interval** - Enter the interval between the transmission of PIM-SM Join/Prune messages. The valid values are from (10 to 3600 secs). The default value is 60.

**Data Threshold Rate** - Enter the minimum source data rate in K bits/second above which the last-hop router will switch to a source-specific shortest path tree. The valid values are from (0 to 2000 K bits/sec) . The default value is 50.

**Register Threshold Rate** - Enter the minimum source data rate in K bits/second above which the Rendezvous Point router will switch to a source-specific shortest path tree. The valid values are from (0 to 2000 K bits/sec) . The default value is 50.

### Command Buttons

**Submit** - Send the updated configuration to the router. Configuration changes take effect immediately. These changes will not be retained across a power cycle unless a save is performed.

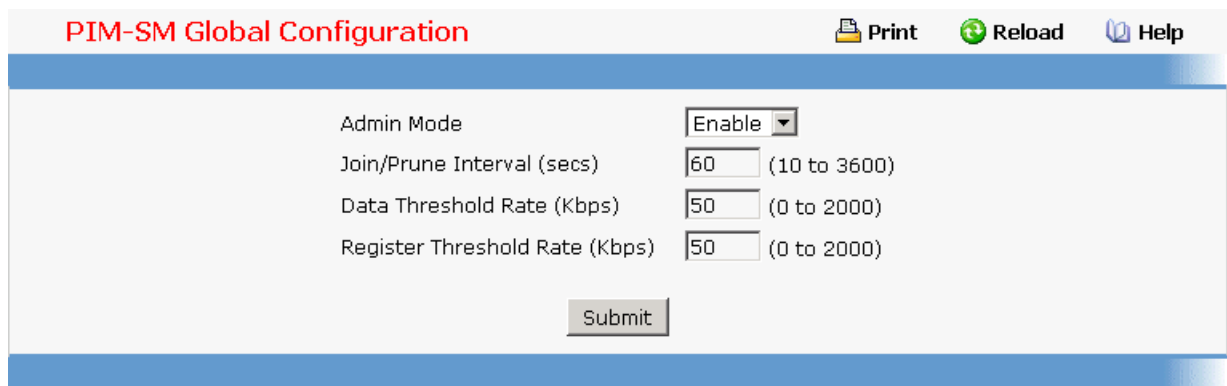

### 11.2.7.6.2. Viewing PIM-SM Global Configuration Page

#### Non-Configurable Data

**Admin Mode** - The administrative status of PIM-SM in the router: either enable or disable.

**Join/Prune Interval** - The interval between the transmission of PIM-SM Join/Prune messages.



**Data Threshold Rate** - The minimum source data rate in K bits/second above which the last-hop router will switch to a source-specific shortest path tree.

**Register Threshold Rate** - The minimum source data rate in K bits/second above which the Rendezvous Point router will switch to a source-specific shortest path tree.

#### Command Buttons

**Refresh** - Refresh the data on the screen with the present state of the data in the router.

PIM-SM Global Status

 **Print**
 **Reload**
 **Help**

Admin Mode	Enable
Join/Prune Interval (secs)	60
Data Threshold Rate (Kbps)	50
Register Threshold Rate (Kbps)	50

### 11.2.7.6.3. Configuring Interface's PIM-SM Configuration Page

#### Selection Criteria

**Slot/Port** - Select the slot and port for which data is to be displayed or configured. Slot 0 is the base unit.

#### Configurable Data

**Mode** - Select enable or disable from the pulldown menu to set the administrative status of PIM-SM in the router. The default is disable.

**Hello Interval (secs)**- Enter the time in seconds between the transmission of which PIM Hello messages on this interface. The valid values are from (10 to 3600 secs) . The default value is 30.

**CBSR Preference** - Enter the preference value for the local interface as a candidate bootstrap router. The value of -1 is used to indicate that the local interface is not a candidate BSR interface. The valid values are from (-1 to 255) The default value is 0.



**CBSR Hash Mask Length** - Enter the CBSR hash mask length to be advertised in bootstrap messages if this interface is elected as the bootstrap router. This hash mask length will be used in the hash algorithm for selecting the RP for a particular group. The valid values are from (0 to 32). The default value is 30.

**CRP Preference** - Enter the preference value for the local interface as a candidate bootstrap router. The value of -1 is used to indicate that the local interface is not a candidate BSR interface. The valid values are from (-1 to 255). The default value is 0.

#### Command Buttons

**Submit** - Send the updated configuration to the router. Configuration changes take effect immediately. These changes will not be retained across a power cycle unless a save is performed.

PIM-SM Interface Configuration

 Print
  Reload
  Help

---

Slot/Port	<input type="text" value="0/1"/>	
Mode	<input type="text" value="Enable"/>	
Hello Interval (secs)	<input type="text" value="30"/>	(10 to 3600)
CBSR Preference	<input type="text" value="0"/>	(-1 to 255)
CBSR Hash Mask Length	<input type="text" value="30"/>	(0 to 32)
CRP Preference	<input type="text" value="0"/>	(-1 to 255)

#### 11.2.7.6.4. Viewing Interface's PIM-SM Configuration Page

##### Selection Criteria

**Slot/Port** - Select the slot and port for which data is to be displayed. Slot 0 is the base unit.

##### Non-Configurable Data

**Mode** - The administrative status of PIM-SM in the router: either enable or disable.

**Protocol State** - The operational state of the PIM-SM protocol on this interface.

**IP Address** - The IP address of the selected PIM interface.

**Net Mask** - The network mask for the IP address of the selected PIM interface.

**Designated Router** - The Designated Router on the selected PIM interface. For point-to-point interfaces, this object has the value 0.0.0.0.

**Hello Interval (secs)** - The frequency at which PIM Hello messages are transmitted on the selected interface.

**CBSR Preference** - The preference value for the local interface as a candidate bootstrap router. The value of -1 is used to indicate that the local interface is not a candidate BSR interface.

**CBSR Hash Mask Length** - The CBSR hash mask length to be advertised in bootstrap messages if this interface is elected as the bootstrap router. This hash mask length will be used in the hash algorithm for selecting the RP for a particular group.

**CRP Preference** - The preference value for the local interface as a candidate bootstrap router. The value of -1 is used to indicate that the local interface is not a candidate BSR interface.

**Neighbor Count** - The number of PIM neighbors on the selected interface.

**IP Address** - The IP address of the PIM neighbor for this entry.



**Up Time** - The time since this PIM neighbor (last) became a neighbor of the local router.

**Expiry Time** - The minimum time remaining before this PIM neighbor will be aged out.

##### Command Buttons

**Refresh** - Refresh the data on the screen with the present state of the data in the router.

**PIM-SM Interface Summary**

 **Print**
 **Reload**
 **Help**

---

Slot/Port	0/1
Mode	Disable
Protocol State	Non-Operational
IP Address	192.168.100.22
Net Mask	255.255.255.0
Designated Router	0.0.0.0
Hello Interval (secs)	30
CBSR Preference	0
CBSR Hash MaskLength	30
CRP Preference	0
Neighbor Count	0

IP Address	Up Time (hh:mm:ss)	Expiry Time (hh:mm:ss)
192.168.101.3	00:01:44	00:01:30

### 11.2.7.6.5. Viewing PIM-SM Component Summary Page

#### Non-Configurable Data

**Component Index** - Unique number identifying the component index.

**Component BSR Address** - Displays the IP address of the bootstrap router (BSR) for the local PIM region.



**Component BSR Expiry Time** - Displays the minimum time remaining before the bootstrap router in the local domain will be declared.

**Component CRP Hold Time** - The hold time of the component when it is a candidate Rendezvous Point in the local domain.

#### Command Buttons

**Refresh** - Refresh the data on the screen with the present state of the data in the router.

**PIM-SM Component Summary**

 **Print**
 **Reload**
 **Help**

---

Component Index	Component BSR Address	Component BSR Expiry Time (hh:mm:ss)	Component CRP Hold Time (hh:mm:ss)
1	192.168.101.5	00:00:10	00:00:10



### 11.2.7.6.6. Viewing PIM-SM RP Summary Page

#### Non-Configurable Data

**Group Address** - Displays IP multicast group address.

**Group Mask** - Displays Multicast group address mask.

**Address** - Displays IP address of the Candidate-RP.

**Hold Time** - The holdtime of a Candidate-RP.If the local router is not the BSR, this value is 0.

**Expiry Time Component** - The minimum time remaining before the Candidate-RP will be declared.

**Component** – A number which uniquely identifies the component. Each protocol instance connected to a separate domain should have a different index value.

#### Command Buttons

**Refresh** - Refresh the data on the screen with the present state of the data in the router.

PIM-SM RP Set Summary					
Group Address	Group Mask	Address	Hold Time (hh:mm:ss)	Expiry Time (hh:mm:ss)	Component
224.0.0.0	240.0.0.0	192.168.101.3	00:02:00	00:02:30	1
224.0.0.0	240.0.0.0	192.168.101.5	00:02:15	00:02:30	1

### 11.2.7.6.7. Viewing PIM-SM Candidate RP Summary Page

#### Non-Configurable Data



**Group Address** - The group address transmitted in Candidate-RP-Advertisements.

**Group Mask** - The group address mask transmitted in Candidate-RP-Advertisements to fully identify the scope of the group which the router will support if elected as a Rendezvous Point.

**Address** - Displays the unicast address of the interface which will be advertised as a Candidate RP.

#### Command Buttons

**Refresh** - Refresh the data on the screen with the present state of the data in the router.

**PIM-SM Candidate RP Summary** 
 Print
  Reload
  Help

Group Address	Group Mask	Address
224.0.0.0	240.0.0.0	192.168.101.5

### 11.2.7.6.8. Configuring PIM-SM Static RP Configuration Page

#### Configurable Data

**IP Address** - IP Address of the RP to be created or deleted.



**Group** - Group Address of the RP to be created or deleted.

**Group Mask** - Group Mask of the RP to be created or deleted.

#### Command Buttons

**Submit** - Attempts to create the specified static RP IP Address for the PIM-SM router. Configuration changes take effect immediately. These changes will not be retained across a power cycle unless a save is performed.

**Delete** - Attempts to remove the specified static RP IP Address for the PIM-SM router. Configuration changes take effect immediately. These changes will not be retained across a power cycle unless a save is performed.

**PIM-SM Static RP Configuration** 
 Print
  Reload
  Help

IP Address	<input type="text" value="0.0.0.0"/>
Group	<input type="text" value="0.0.0.0"/>
Group Mask	<input type="text" value="0.0.0.0"/>

**IP Address    Group    Group Mask**