



DLT™ MiniLibrary (TL891)

User's Guide

EK-TL891-UG. A01

Digital Equipment Corporation
Maynard, Massachusetts

First Edition, July 1997

The information in this document is subject to change without notice and should not be construed as a commitment by Digital Equipment Corporation. Digital Equipment Corporation assumes no responsibility for any errors that may appear in this document.

Restricted Rights: Use, duplication, or disclosure by the U.S. Government is subject to restrictions as set forth in subparagraph (c) (1) (ii) of the Rights in Technical Data and Computer Software clause at DFARS 252.227-7013.

Digital Equipment Corporation does not give a warranty of any kind regarding the fitness or applicability of the information content for a particular purpose. The user assumes all responsibility for understanding the interrelationships of this enclosed information with other affected software or system products.

The disclosure of this information does not grant to the user a license under any patents, pending patents, trademarks, or copyrights or other rights of Digital Equipment Corporation, or of any third party.

UNIX is a registered trademark in the United States and other countries, licensed exclusively through X/Open Company, Ltd.

DLT is a trademark of QUANTUM Corporation

The following are trademarks of Digital Equipment Corporation:

DEC DIGITAL StorageWorks
OpenVMS TZ89
and the DIGITAL Logo

© Digital Equipment Corporation 1997
Printed in U. S. A

All Rights Reserved

Contents

About This Guide	ix
1 Introduction	
1.1 Models	1-1
1.2 Features.....	1-2
1.3 Advanced Design Features	1-4
2 Operation	
2.1 Front Panel.....	2-1
2.2 Control Panel	2-2
2.3 Display Messages.....	2-5
2.4 Selecting Control Panel Display Modes.....	2-7
2.5 Navigating Through the Menu Structure.....	2-10
2.6 Displaying Firmware Revision	2-14
2.7 Displaying Error Logs	2-15
2.8 Inserting and Removing the Magazine.....	2-16
2.9 Tape Cartridge Requirements	2-18
3 Regular Maintenance	
3.1 Cleaning Cartridge	3-1
4 Configuration	
4.1 How to Customize Configuration	4-1
4.2 Descriptions of Configuration Options	4-4
5 Diagnostics and Troubleshooting	
5.1 Diagnosing Problems	5-1
5.2 Error Recovery	5-2
5.3 Fault Symptom Codes	5-4
5.4 Using CE Diagnostics.....	5-16
5.5 Using the Demo Submenu.....	5-18

Appendix A

Specifications	A-1
----------------------	-----

Appendix B

Installation	B-1
B.1 Mechanical Installation	B-1
B.2 Interfaces and Cabling	B-10
B.3 Interface Cable Specifications	B-12

Appendix C

Accessories	C-1
C.1 Data and Cleaning Cartridge Ordering Information	C-1
C.2 Bar Code Label and Magazine Ordering Information	C-1

Appendix D

Regulatory Information	D-1
------------------------------	-----

Appendix E

Product Notes for Sun	E-1
-----------------------------	-----

Readers Comment Form	Inside Back Cover
-----------------------------------	-------------------

Figures

1-1 Front View	1-2
1-2 Tape Cartridge Magazine	1-3
1-3 Rear View	1-3
2-1 Front Panel	2-1
2-2 Control Panel	2-2
2-3 POST Screen	2-5
2-4 Initialization Screen	2-5
2-5 Default Screen	2-6
2-6 Fault Screen	2-7
2-7 MiniLibrary Menu Structure	2-8
2-8 Main Menu	2-9
2-9 Show Status Submenu	2-10
2-10 Library Status Submenu	2-11
2-11 Drive Status Submenu	2-12
2-12 MAP Info Submenu	2-13
2-13 Error History Screen	2-15

2-14 Magazine In Place.....	2-17
2-15 Tape Magazine With Cartridge Installed	2-18
2-16 CompacTape Cartridge.....	2-20
2-17 Default Screen.....	2-21
2-18 Main Menu.....	2-21
2-19 Load/Unload Initial Screen.....	2-21
2-20 Load/Unload 'From' Entry Screen.....	2-23
2-21 Load/Unload 'To' Entry Screen.....	2-23
2-22 Confirmation Screen	2-24
2-23 Load/Unload 'In Progress' Screen	2-24
2-24 Updated Default Screen.....	2-24
3-1 Main Menu	3-3
3-2 Maintenance Submenu	3-3
3-3 Cleaning Submenu	3-3
3-4 Cleaning Confirmation Screen.....	3-4
3-5 Cleaning In Progress Screen.....	3-4
4-1 Default Screen.....	4-2
4-2 Main Menu	4-2
4-3 Configure Submenu.....	4-2
4-4 Drive Selection Submenu	4-3
4-5 DLT2 Set Data Format Submenu.....	4-3
4-6 Main Menu	4-5
4-7 Configure Submenu.....	4-6
4-8 Library Mode Selection Menu.....	4-6
4-9 Configure Submenu.....	4-7
4-10 Special Config Submenu	4-7
5-1 Troubleshooting Flowchart.....	5-2
5-2 Main Menu	5-16
5-3 Maintenance Submenu	5-16
5-4 Diagnostic Submenu	5-17
B-1 Separating a Rack Slide	B-2
B-2 Parts List for Standard EIA/RETMA Rackmounting	B-4
B-3 Parts List for Storageworks Metric Rackmounting.....	B-6
B-4 Metric Rackmount Installation Layout.....	B-9
B-5 Rear Panel Connectors, Terminator and Cables.....	B-10

Tables

1-1	Tape Capacities	1-5
2-1	Control Panel Button Functions	2-4
2-2	Tape Capacities	2-19
4-1	MiniLibrary Configuration Options	4-8
5-1	Error Recovery Procedures (ERP)	5-3
5-2	Fault Symptom Codes (FSC)	5-4
A-1	Acoustic Noise Declaration for German Noise Declaration Labor	A-4
C-1	Data and Cleaning Cartridge Ordering Information	C-1
C-2	Bar Code Label and Magazine Ordering Information	C-1

About This Guide

This guide describes how to install and operate the DLT MiniLibrary Base Module. It also provides procedures for configuring, monitoring, troubleshooting and performing cleaning maintenance on the device to maintain optimum performance.

Audience

This guide supports the user familiar with installing and configuring storage hardware. You should understand basic SCSI concepts such as configuring device IDs, interconnecting devices and SCSI cable termination, and be able to perform basic, menu-driven diagnostics and error recovery procedures.

Related Documentation

TZ89 DLT™ Series Tape Drive User's Guide

EK-TZ89N-UG

Organization

This guide contains the following:

Chapter 1: *Introduction* - Describes the DLT MiniLibrary models available; their SCSI interface and physical configurations, as well as system expansion capacity and features.

Chapter 2: *Operation* - Describes how to utilize the front panel, control panel, display and menu features of the DLT MiniLibrary and provides tape cartridge handling procedures.

Chapter 3: *Regular Maintenance* - Describes the procedures for running/replacing the cleaning cartridge in the DLT MiniLibrary Base Module.

Chapter 4: *Configuration* - Describes how to customize configuration of the DLT MiniLibrary and defines configuration options.

Chapter 5: *Diagnostics and Troubleshooting* - Describes the procedures for diagnosing platform problems and drive errors which can cause the DLT MiniLibrary Base Module to malfunction. It also provides Fault Symptom Codes and Error Recovery Procedures to help restore operability.

Visit Our Web Site for the Latest Information

Check our web for the latest drivers , technical tips, and documentation. We can be found in the technical area of our web page, <http://www.storage.digital.com/>

1

Introduction

The DLT MiniLibrary Base Module is the foundation of an expandable, modular tape library system. The MiniLibrary system is designed for high duty-cycle on-line and near-on-line applications, such as hierarchical storage management (HSM). It is a superior performer in high volume backup and archival service as well.

1.1 Models

The DLT MiniLibrary Base Module is available as a TL891 model that can be upgraded to a two drive TL892. Both models can use either CompacTape III, CompacTape IIIXT and higher-density CompacTape IV cartridges. Both types of media are rated at over 1,000,000 head passes.

The Base Module contains one TZ89N DLT tape drive plus a 10-cartridge magazine with a rugged random access loader mechanism. The third digit of the model number (1) denotes the number of drives in the unit.

1.1.1 SCSI Interface Configuration

The Base Module's standard SCSI interface is standard fast SCSI with SCSI-2 (high-density 68-pin D-series) connectors. The section on Interfaces in *Appendix B - Installation* describes the available interface options.

Data Transfer Rates:

The data transfer rate of the DLT MiniLibrary is dependent on the type of drives and on the SCSI bus configuration. The bandwidth of the SCSI bus is limited. As a result, the transfer rate of exceptionally fast drives such as the TZ89N series can be limited by sharing a SCSI bus with another drive or with the library robotics.

Internal Cabling Configuration:

Each model is available in a daisy-chained SCSI configuration, or with separate SCSI connections for the library robotics and each of the drives. These configurations are described in more detail in *Appendix B - Installation*.

1.2 Features

Figures 1-1, 1-2 and 1-3 identify some of the external features of the TL891.

Figure 1-1 Front View

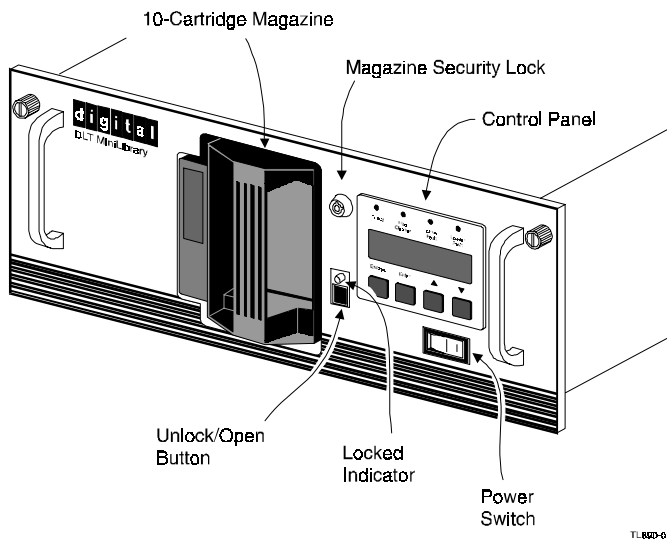

1.2.1 Control Panel

The control panel features a 4-line by 20-character backlit LCD display, four LED indicators and four buttons. The buttons enable the operator to navigate through the menu structure to select and display operating modes, device status, diagnostic and maintenance functions, device history and error statistics, and system configuration. The functions of the control panel are described in detail in *Chapter 2 - Operation*.

1.2.2 Power Supply

The AC Power switch is located on the front panel of the module. The autoranging power supply will adjust automatically to either of two operating voltage ranges. The ranges are 100-120 VAC and 200-240 VAC. The power supply is capable of operating at 50 or 60 Hz without requiring any modification. AC power is supplied to the power supply by a single cable which can be plugged into any properly grounded outlet.

1.2.3 Tape Cartridge Magazine

The ten-cartridge magazine is removable from the front panel, but is protected from tampering by a key-operated Magazine Security Lock which must be unlocked before the magazine can be removed. The rugged carbon-fiber-reinforced polymer magazine fits into an extruded track, which assures precise positioning with respect to the library robotics. A tape magazine is shown in Figure 1-2. Insertion and removal of the magazine is described in *Chapter 2 - Operation*.

Figure 1-2 Cartridge Magazine

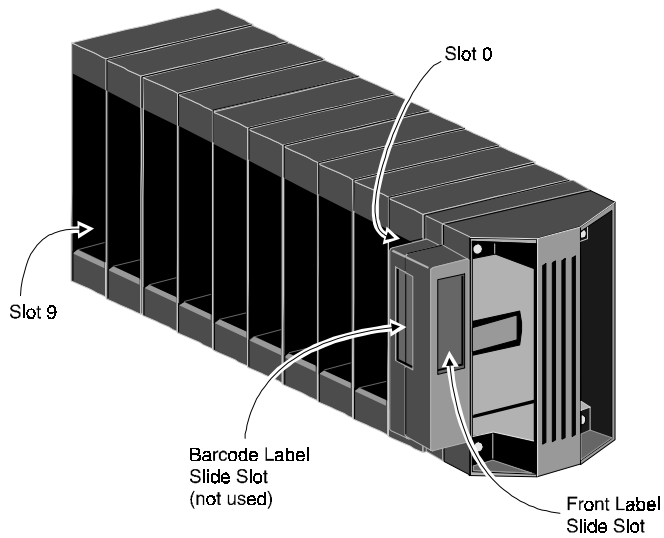
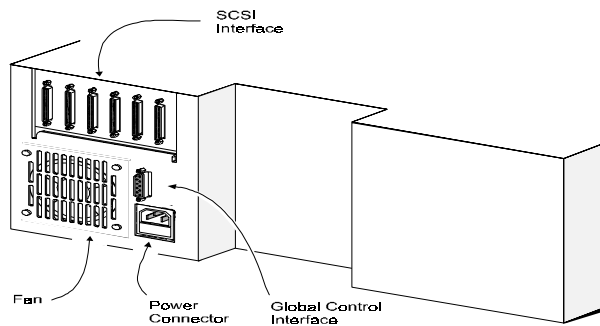

Figure 1-3 Rear View



1.2.4 Integral Fan Cooling

A single forced-air fan is positioned on the rear panel to provide optimum cooling for critical parts, and to prevent the drive and robotics electronics, motors and power supply from overheating.

1.2.5 Library Robotics

The DLT MiniLibrary features library robotics that can load any of the cartridges in the system into either of two TZ89N tape drives from its own removable 10-cartridge magazine.

1.2.6 Bar Code Reader

The bar code reader is mounted on the cartridge shuttle. It reads bar code labels attached to each cartridge and to the magazine, and maintains the bar code data in memory as part of the library inventory records.

1.3 Advanced Design Features

The DLT MiniLibrary incorporates many significant improvements in tape drive and library design. One of the most important is the use of highly reliable DLT technology, with media rated at better than 1,000,000 head passes.

1.3.1 Embedded Diagnostics

The DLT MiniLibrary Base Module provides three levels of embedded diagnostics. The Power-On Self Test (POST) performs various verification tests on the processor's host interface and device control functions, as well as memory tests, at power-up. The second level of diagnostics is the User Diagnostics. These include provision for changing configuration options, and diagnostics under the Demo menu to assist the user in diagnosing faults. The third level, CE Diagnostics, include more advanced diagnostics to be used by Customer Engineers for servicing the Base Module. Both the User Diagnostics and the CE Diagnostics may be selected from the front panel.

Diagnostics are described in greater detail in *Chapter 4 - Configuration* (configuration diagnostics) and *Chapter 5 - Diagnostics and Troubleshooting* (remaining user diagnostics).

1.3.2 Error Checking

The TL891 and TL892 Base Modules apply a 16-bit parity check to each record, a 64-bit CRC to each 4kB of data, and Reed-Solomon error correction code overall. In addition, there is an internal parity check on the data buffer.

1.3.3 Compression

The drives in the DLT MiniLibrary Base Module use the standard Digital Lempel-Ziv (DLZ) data compression algorithm when compression is enabled.

1.3.4 Capacity

A Base Module with its ten-cartridge magazine offers formatted capacities as shown below. When the TZ89n uses CompacTape III or IIIXT cartridges, its capacity is limited accordingly.

Table 1-1 Tape Capacities*

DENSITY	CARTRIDGE	CAPACITY PER CARTRIDGE ^A	FULL MAGAZINE COMPRESSED ^B
TZ87	CompacTape III	10 GB	200 GB
TZ88	CompacTape IIIXT	15 GB	300 GB
TZ88	CompacTape IV	20 GB	400 GB
TZ89	CompacTape IV	35 GB	700 GB

^ANative capacities, uncompressed.

^BMaximum capacities given assume average 2:1 compression. Actual compression will vary with file content. The native capacity for a full magazine is ten times the native capacity per cartridge.

* For additional tape capacity information refer to the TZ89N User Guide (EK-TZ89N-UG).

1.3.5 Media Life

The media used in the DLT MiniLibrary is rated at over 1,000,000 head passes, and a shelf life of at least 30 years.

2

Operation

This chapter describes how to utilize the front panel, control panel, display and menu features of the DLT MiniLibrary Base Module, and provides procedures for magazine and tape cartridge insertion and removal.

2.1 Front Panel

The front panel includes the power switch, the magazine door, the Magazine Security Lock, the Unlock/Open button with its Locked indicator, and the control panel which has buttons, a display and indicators. Figure 2-1 shows the front panel.

Figure 2-1 Front Panel

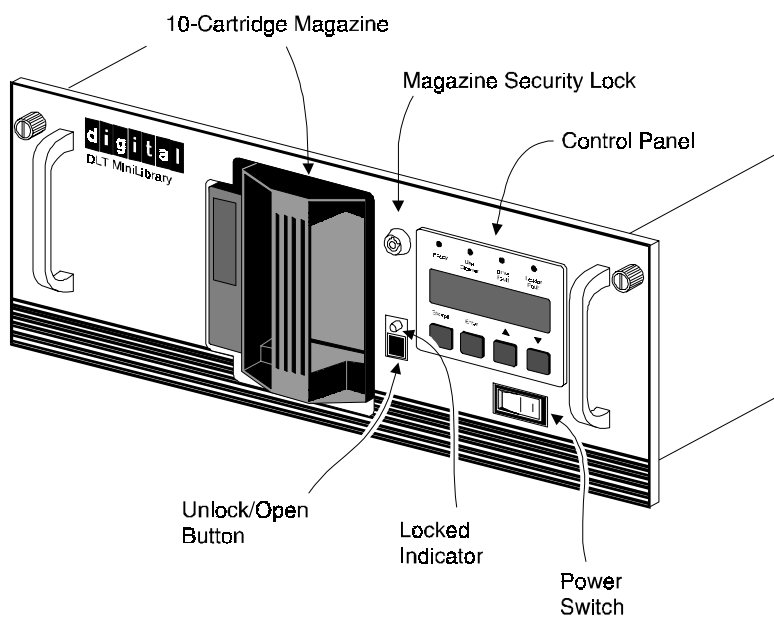

TL890-01

2.1.1 Power Switch

The power switch controls the supply of AC power to the module. It is set into a recess in the front panel to prevent accidental operation. Press **1** to turn the module ON and **0** to turn the module OFF.

2.1.2 The Magazine Security lock, the Unlock/Open Button and the Locked Indicator LED

These features are described later in this chapter under the heading 'Inserting and Removing the Magazine

.'

2.2 Control Panel

The control panel consists of four LED indicators, a four-line by 20-character backlit LCD display, and four buttons. Figure 2-2 shows the control panel.

Figure 2-2 Control Panel

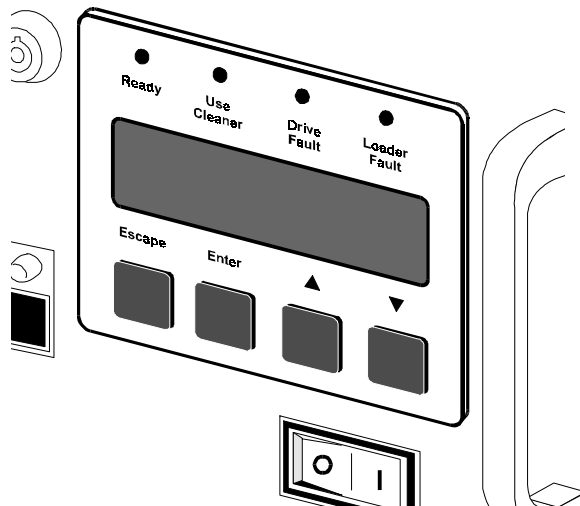

2.2.1 Indicators

There are four LED indicators on the control panel, labeled **Ready** (green), **Use Cleaner** (yellow), **Drive Fault** (red), and **Loader Fault** (red), and they function as follows:



Ready (green) - illuminated when the DLT MiniLibrary is ready to accept commands, either from the Control Panel or from the host computer. The **Ready** indicator goes out when you enter the Menu Mode.

Use Cleaner (yellow) - indicates that one or both drives require cleaning. A cleaning operation should be performed as described in **Chapter 4 - Regular Maintenance**. When the **Use Cleaner** LED comes on, you can find out which drive needs cleaning by selecting Cleaning Needed on the Drive Status submenu.

Drive Fault (red) - indicates that a hardware error occurred in either or both drives. Refer to the TZ89N DLT Tape Drive User's Guide for the drives in your MiniLibrary for Error Recovery Procedures.

Loader Fault (red) - illuminated when a Fault Screen appears on the LCD display. The Fault Screen is described later in this chapter. A list of Fault Symptom Codes (FSC) and Error Recovery Procedures (ERP) appears in **Chapter 5 - Diagnostics and Troubleshooting**.

2.2.2 Buttons

There are four buttons on the control panel, labeled **Escape**, **Enter**, , and . The buttons do not directly control specific functions or options. Instead, you use the buttons to navigate from the Default Screen through a multi-level menu structure, then select the desired option from the appropriate menu using the **Enter** button. Table 2-1 describes the effect of each of the four buttons under various conditions.





The two most important things you need to know about the buttons are:

- To enter the Menu Mode and display the Main Menu from the Default Screen, press the **Enter** button.
- To return to the Main Menu from a submenu, press the **Escape** button repeatedly until the Main Menu appears. Pressing the **Escape** button while the Main Menu is displayed exits the Menu Mode and returns you to the Default Screen. The Default Screen is shown in Figure 2-5; the Main Menu is shown in Figure 2-8.



NOTE

When you enter the Menu Mode, the **Ready** light goes out. This means that the module is *off-line*, and all medium changer commands from the host return a SCSI 'not ready' status until you exit the Menu Mode and the **Ready** light goes on. In addition, the magazine Unlock/Open button does not work when the **Ready** light is out.

Table 2-1 Control Panel Button Functions

	Escape	Enter		
At POST Screen	N/A	N/A	N/A	N/A
At Default Screen	Displays "Show Status" Menu	Enters menu mode	N/A	N/A
In Menu Mode	Rejects currently displayed choice, or Aborts control panel operation In progress, or Exits to next higher menu level, or Exits menu mode to default screen	Accepts currently displayed choice	Moves  1 line upward through list of options, or Scrolls part of display 1 line toward top of list of options	Moves  1 line downward through list of options, or scrolls part of display 1 line toward bottom of list of options
At Fault Screen	N/A	Clears soft errors	N/A	N/A

NOTE

There is an auto-repeat feature for the  and  buttons. When the user presses either button for more than one-half second, the control panel behaves as if the user were pressing and releasing the button about four times per second. This effect stops when the user releases the button.

2.3 Display Messages

The display on the control panel is capable of displaying four lines of 20 characters each, to allow the use of easy-to-understand messages. Many of these messages and their functions are described in this chapter. Those displays that are described in other chapters are cross-referenced here as well.

2.3.1 Power-On Self Test Screen

When power is first applied to the module, a series of power-on self test (POST) diagnostics are performed. During POST execution, the model number of the module, the current date and time, the firmware revision, and the status or result of the test in progress are displayed on the control panel as shown in figure 2-3.

Figure 2-3 POST Screen

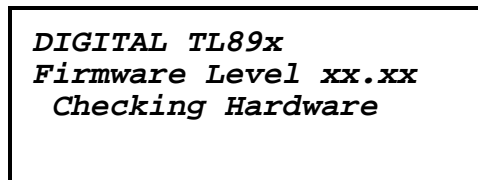

```
DIGITAL TL89x  
Firmware Level xx.xx  
Checking Hardware
```

NOTE

xx.xx represents decimal placeholders for the current firmware revision level.

2.3.2 Initialization Screens

After the POST is completed, the library robotics system is initialized. A series of screens similar to Figure 2-4 is displayed during this process.

Figure 2-4 Initialization Screen

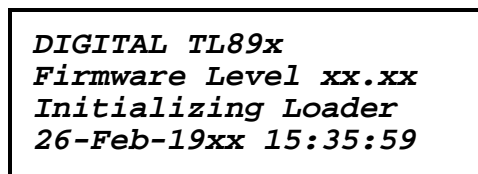

```
DIGITAL TL89x  
Firmware Level xx.xx  
Initializing Loader  
26-Feb-19xx 15:35:59
```

NOTE

xx.xx represents decimal placeholders for the current firmware revision level.

2.3.3 Default Screen

After the POSTdiagnostics have concluded successfully and initialization is complete, the default screen appears, as shown in Figure 2-5.

Figure 2-5 Default Screen

```
DLT0 Seeking
DLT1 Idle
Loader Idle
0 1 _ 3 _ 5 6 7 8 9
```

The first and second lines of the Default Screen show the status of the tape drive within the MiniLibrary. The possible status conditions of the drives are

- No Tape
- Idle
- Rewinding
- Seeking
- Reading
- Writing
- Erasing
- Cleaning

The third line of the display tells the status of the library robotics. The possible conditions of the library robotics are:

- Idle
- Fetching
- Stowing
- Moving
- Diag Active
- Diag Complete
- Taking Inventory
- Checking Drives
- Checking Labels
- Orphaned Cartridge
- Trapped Cartridge

The fourth line is a map of the magazine with numbers from 0 to 9 representing the cartridge slots. The numbers which are present on this line indicate that a cartridge is present in the corresponding slot of the magazine. An underline means that there is no cartridge present in that slot. In Figure 2-5, the cartridges from slots 3 and 5 are not in the magazine, but are in drives 0 and 1.

2.3.4 Fault Screen

When a fault is detected, a screen similar to Figure 2-6 appears. At the same time, either the Drive Fault or the Loader Fault LED is illuminated.

Figure 2-6 Fault Screen

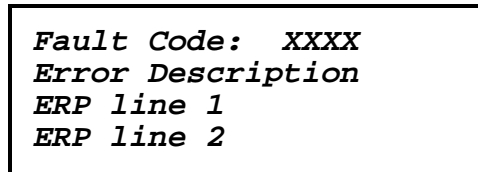

```
Fault Code: XXXX
Error Description
ERP line 1
ERP line 2
```

The first line in Figure 2-6 shows a numerical fault symptom code (FSC). The second line shows a brief description of the error, in place of the words 'Error Description.' The third and fourth lines will contain a one- or two-line message describing the initial error recovery procedure (ERP) in place of the words shown in the figure.

A list of the fault symptom codes (FSC) and error recovery procedures (ERP) appears in **Chapter 5 - Diagnostics and Troubleshooting**.

2.4 Selecting Control Panel Display Modes

As previously described, the POST Screens, the Initialization Screen and the Default Screen appear without operator or host intervention. The Fault Screens appear whenever a fault occurs. The screens which follow appear in response to operator actions.

2.4.1 The Mini-Library Menu Structure

Figure 2-7 shows the structure of the MiniLibrary menus.

Figure 2-7 MiniLibrary Menu Structure

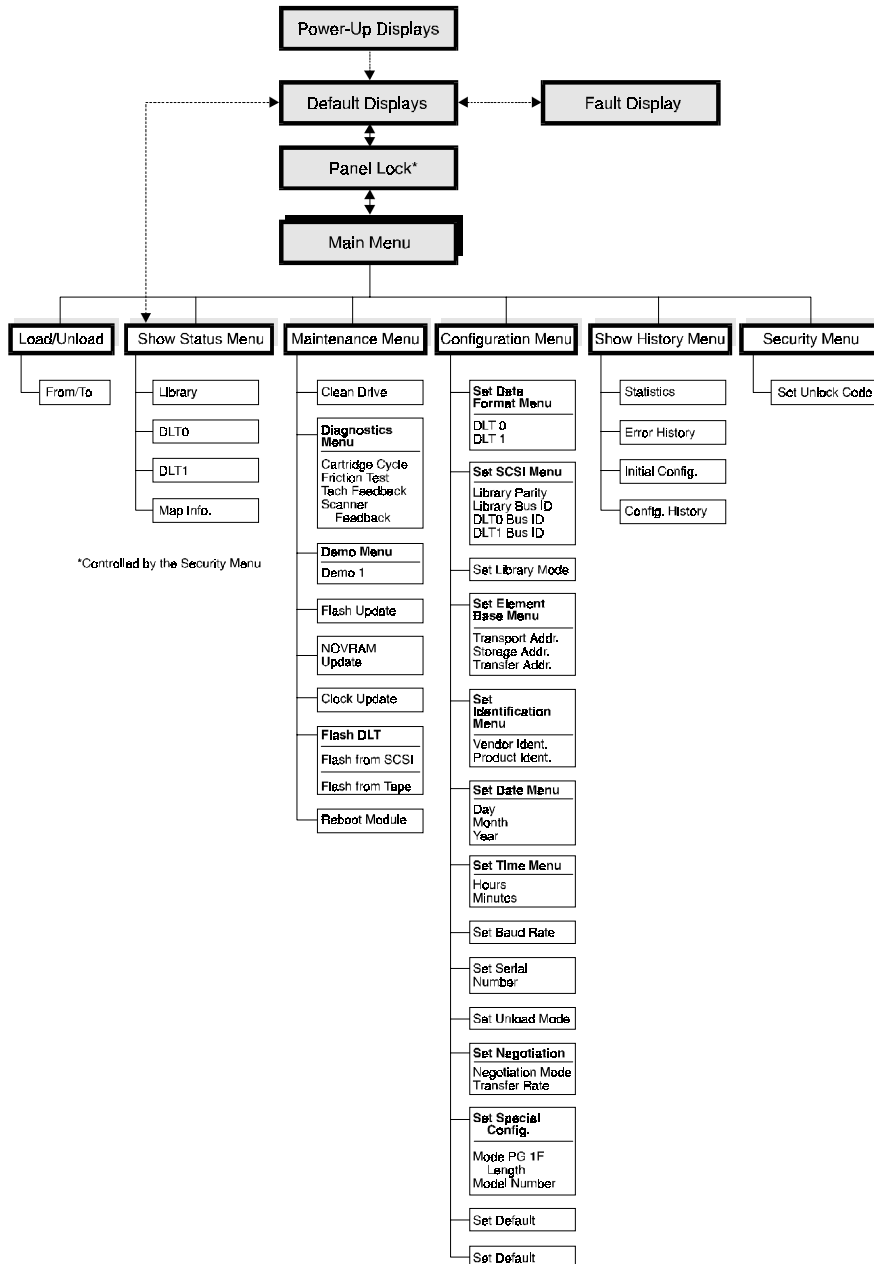

2.4.2 Entering the Menu Mode

NOTE

When you enter the Menu Mode, the **Ready** light goes out. This means that the module is *off-line*, and all medium changer commands from the host return a SCSI 'not ready' status until you exit the Menu Mode and the **Ready** light goes on.

When the Default Screen appears on the screen, you can enter the Menu Mode by pressing the **Enter** button. The Main Menu shown in Figure 2-8 appears.

Figure 2-8 Main Menu

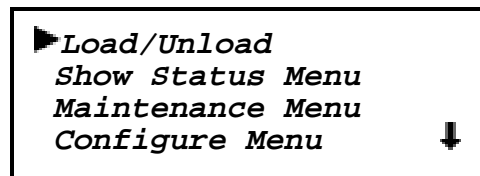

2.4.3 Exiting the Menu Mode

To leave the menu mode and return to the Default Screen, press the **Escape** button repeatedly. Each time you press the **Escape** button, the display moves to a higher menu level. When the Main Menu is visible, pressing the **Escape** button once returns to the Default Screen.

NOTE

When you see a ▶ on line 1 or a ↓ on line 4 of the display, this means that some or all of the display may be scrolled in the indicated direction to reveal more choices.

2.5 Navigating Through the Menu Structure

To select a submenu, move the **▶** on the display to the desired line using the **▲** and **▼** buttons. Then press the **Enter** button to confirm your choice and display the submenu. The **↓** at the end of the fourth line of the Main Menu means that there are one or more additional items that can be reached by scrolling, using the **▼** button. The items available on the Main Menu are:

- Load/Unload
- Show Status Menu
- Maintenance Menu
- Configure Menu
- Show History Menu

The following paragraphs describe the submenus that correspond to each of the Main Menu selections.

2.5.1 Load/Unload Submenu

The Load/Unload Submenu is described later in this chapter, under the heading 'Loading and Unloading Tapes.'

2.5.2 Show Status Submenu

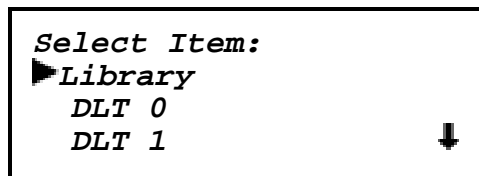

When you select Show Status, the submenu shown in Figure 2-9 appears.

Figure 2-9 Show Status Submenu



The items available on the Show Status Menu are:

- Library
- DLT0
- DLT1
- MAP Info (only if bar code reader is installed).

Move the  up or down with the  and  buttons, then press the **Enter** button to select the item.

Library Status Submenu

When you select Library, the submenu in Figure 2-10 appears.

Figure 2-10 Library Status Submenu

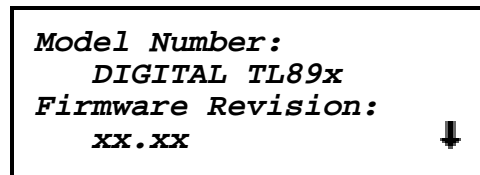

NOTE

xx.xx represents decimal placeholders for the current firmware revision level.

This screen is scrollable. The list of Library Status categories available is as follows:

- Model Number
- Firmware Revision
- Date
- Time
- Loader Status
- Library Mode
- Library Configuration
- Vendor Identification
- Product Identification
- Transport Address
- Storage Address
- Transfer Address
- Serial Number
- Wide SCSI
- SCSI Bus Parity
- SCSI Bus ID
- Negotiation Mode
- Transfer Rate
- Unload Mode
- Reserved Slots
- Mode Page 1F Length
- TUR Reporting
- Init Element Status
- Boot Version
- Flash Type
- Baud Rate
- Barcode Reader
- Label Size
- Label Alignment

Drive Status Submenu

When you select either of the drives, the submenu in Figure 2-11 appears.

Figure 2-11 Drive Status Submenu

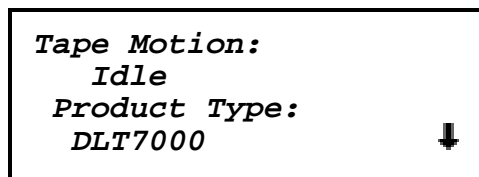

This screen is scrollable. The list of Drive Status categories available is as follows.

- Tape Motion
- Product Type
- Tape Format
- Compression
- SCSI Bus ID
- Drive Revision
- Controller Revision
- Cartridge Present
- Hardware Error
- Cleaning Needed
- Write Protected
- Operate Handle
- Serial Number

*Map Information Submenu***NOTE**

This submenu appears only if a bar code reader is installed. When you select Map Info, the screen in Figure 2-12 appears. The location being reported appears on Line 2 in place of the word 'Location.' The content of the bar code on the label, up to 8 characters, appears on Line 4.

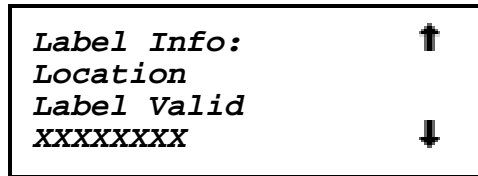
Figure 2-12 Map Info Submenu

Lines 2, 3, and 4 of this screen scroll in unison when you use the ▲ and ▼ buttons. This allows you to read the label information reported for each location in the module that contains a cartridge. The list of Label Info locations available for display on line 2 is as follows.

- DLT0
- DLT1
- Slot0
- Slot1
- Slot2
- Slot3
- Slot4
- Slot5
- Slot6
- Slot7
- Slot8
- Slot9

Depending on the report for each location, Line 3 may display either '**Label Valid,**' or '**Label Not Present.**'

For each location reported, Line 4 will display the actual bar code on the label, up to 8 characters.

2.5.3 Maintenance Menu

The Maintenance Menu and the options under it that are intended for operator use are described in several places. Drive cleaning and firmware upgrades are described in *Chapter 3 - Regular Maintenance*. User demos and system diagnostics are described in *Chapter 5 - Diagnostics and Troubleshooting*.

2.5.4 Configure Menu

The Configure Menu how to use it and the options available under it are described in *Chapter 4 - Configuration*.

2.5.5 Show History Menu

The Show History Menu enables the operator to retrieve the configuration history, the original configuration, as well as statistics on the number of operations the library robotics and the drives have performed. An example of the use of the Show History Menu is given in paragraph 2.7 *Displaying Error Logs*.

2.6 Displaying Firmware Revision

You may display the library robotics firmware revision at any time. It appears as one of the items on the Library Status submenu of the Show Status Menu. It is also displayed on line 3 of the POST Screen and the Initialization Screens.

2.7 Displaying Error Logs

To display the error history of the module, you need to use the Show History menu. Access it as follows.

1. At the Default Screen press the **Enter** button to enter the Menu Mode. The Main Menu is displayed.
2. At the Main Menu, press the **▼** button four times until the **▶** in the display is next to 'Show History Menu'
3. Press the **Enter** button to select the submenu.
4. At the Show History Submenu, press the **▼** button once so that the **▶** in the display is next to 'Error History.'
5. Press the **Enter** button to select the function. A circular list of 4-line error reports is displayed in the format shown in Figure 2-13.

Figure 2-13 Error History Screen

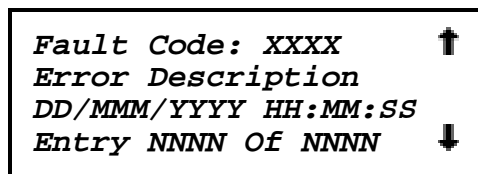

```
Fault Code: XXXX      ↑
Error Description
DD/MMM/YYYY HH:MM:SS
Entry NNNN Of NNNN   ↓
```

6. Using the **▲** and **▼** buttons, scroll the list to display the error history of the module.

The second number on the fourth line is the number of entries. The memory can hold up to 1024 events.

2.8 Inserting and Removing the Magazine

The 10-cartridge tape magazine must be removed from the module in order to insert or remove cartridges.

To insert or remove the magazine, the Magazine Security Lock must be unlocked, using the key supplied with the module. Refer to Figure 2-14. When the Magazine Security Lock is locked, the **Unlock/Open** button has no effect. If inadvertent removal of the magazine is not likely, you may elect to leave the Magazine Security Lock in the unlocked position.

The host computer can enable or disable the **Unlock/Open** button using the SCSI Prevent Allow Medium Removal command. When you press the **Unlock/Open** button, the message 'Locked by Host' will be displayed.

NOTE

When you enter the Menu Mode, the **Ready** light goes out. The magazine cannot be inserted or removed unless the **Ready** light is on. To remove the magazine when a failure prevents the Ready light from illuminating, see the paragraph headed 'Emergency Magazine Removal' later in this chapter.

2.8.1 Removing the Magazine

Whenever a magazine is in place inside the module it is locked in place to prevent tampering or accidental removal. To remove the magazine, the Default Screen must be displayed. Press the **Unlock/Open** button. The lock will release the magazine, permitting it to be pulled out. When the magazine has been removed from the module, the door closes and locks.

NOTE

If there is a cartridge in a drive, the LED on the **Unlock/Lock** button blinks and the control panel requests confirmation.

Figure 2-14 Magazine In Place

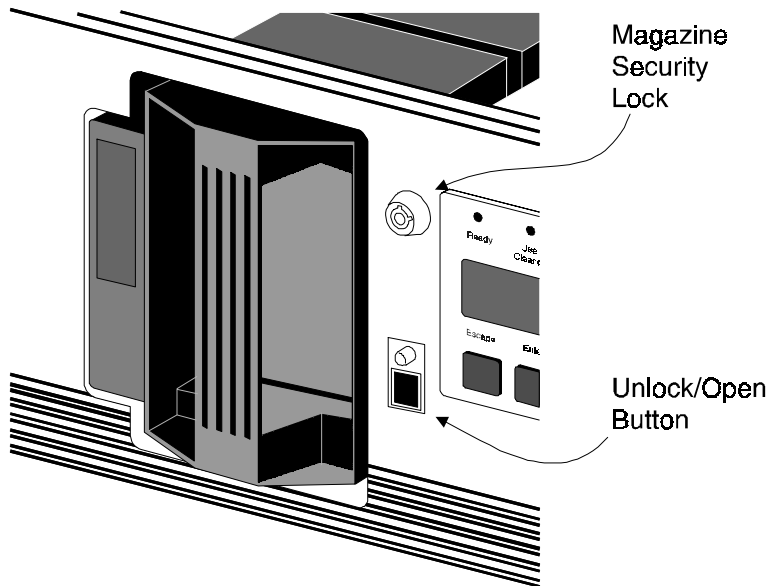

TLB80-02

2.8.2 Emergency Magazine Removal

If a fault occurs that prevents removal of the magazine, turn the power off for five seconds. Power up while continuously pressing only the ▲ button. Continue to hold the button until all of the indicators on the control panel light, then go out. Release the button. The magazine may now be removed without regard to the position of the Magazine Security Lock.

2.8.3 Inserting a Magazine Into the Base Module

Note that the magazine door on the front of the module is closed and locked whenever there is no magazine installed. To open it, press the **Unlock/Open** button on the front panel. When the door has opened, slide the magazine through the door opening, with the cartridges protruding from the left. When the magazine is fully inserted, the lock mechanism automatically locks the magazine in place.

2.8.4 Inserting Cartridges Into the Magazine

A full magazine is shown in Figure 2-15. Insert cartridges so that the label end with the write protect switch is outward, with the write protect switch toward the bottom of the magazine. After you insert the desired cartridges into the magazine, position the module so the cartridges protrude to the left, and the magazine handle is toward you, as shown in Figure 2-15. Insert the magazine into the Base Module with that orientation.

Figure 2-15 Tape Magazine With Cartridges Installed

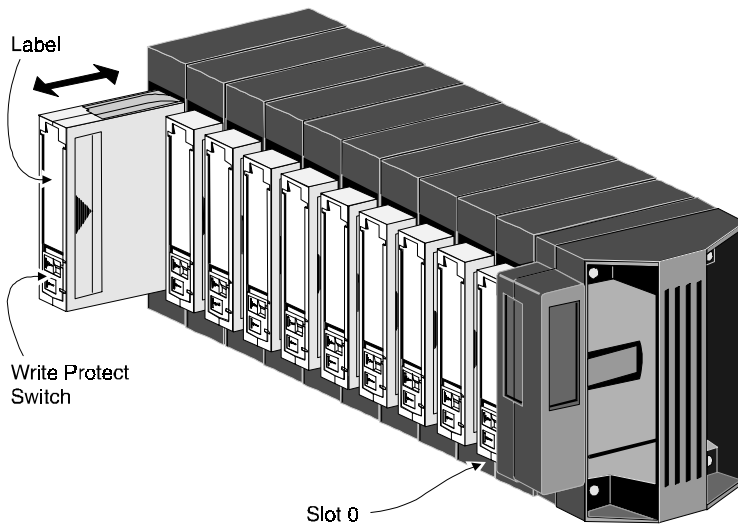

2.9 Tape Cartridge Requirements

A single DLT MiniLibrary with its ten-cartridge magazine offers formatted capacities as shown in Table 2-2. When the TZ89N uses CompacTape III or IIIXT cartridges, its capacity is limited accordingly.

Table 2-2 Tape Capacities*

DENSITY	CARTRIDGE	CAPACITY PER CARTRIDGE	FULL MAGAZINE COMPRESSED
TZ87	CompacTape III	10 GB	200 GB
TZ88	CompacTape IIIXT	15GB	300 GB
TZ88	CompacTape IV	20 GB	400 GB
TZ89	CompacTape IV	35 GB	700 GB

2.9.1 Tape Cartridge Handling and Storage

A CompacTape cartridge should be stored vertically until you select it for use. Do not expose a cartridge to moisture or direct sunlight. Maintain a clean, dust-free working and storage environment.

If a CompacTape cartridge is dropped:

- Inspect the cartridge carefully before you insert it into a MiniLibrary magazine or any drive.
- Shake the cartridge while listening for the sound of a broken part. Any rattling sound means the cartridge is unfit for use.
- Inspect the case for distortion or cracks.
- Inspect the leader by opening the cartridge door as shown in Figure 2-16. The leader should be positioned as shown in view (1), and should protrude at about a five degree angle from the case.

CAUTION!

If the leader is out of position, do not use it;
damage to the drive could result.

*For additional tape capacity information, refer to the TZ89N User Guide (EK-TZ89N-UG).

Figure 2-16 CompacTape Cartridge

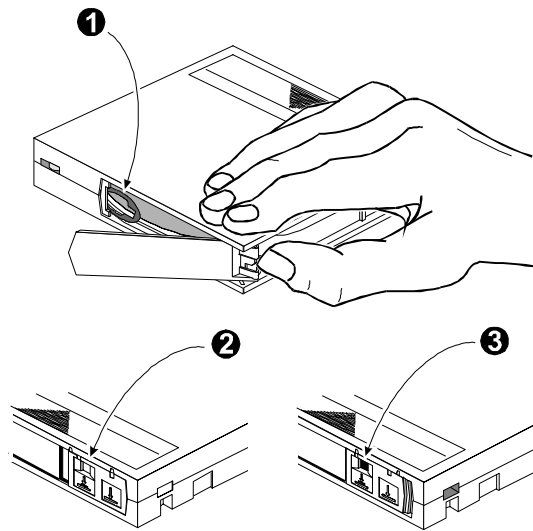

1 - Leader 2 - Write Protect OFF 3 - Write Protect ON

2.9.2 Write Protection

The write protection switch of a CompacTape cartridge is also shown in Figure 2-16. To enable data recording, slide the write protect switch to the right so that no orange color is visible through the window in the write protect switch (2). To write protect the CompacTape cartridge, slide the write protect switch to the left until the orange indicator shows through the window on the write protect switch (3).

2.9.3 Loading and Unloading Tape Cartridges

The Load/Unload submenus enable you to specify a source and a destination for a cartridge movement. As a result, you use exactly the same procedure to load and unload. To load or unload a tape from the front panel of the module, use the Load/Unload menus as follows.

Figure 2-17 Default Screen

```
Dlt0: No Tape
Dlt1: Idle
Loader Idle
0 1 _ 4 5 6 7 8 9
```

A default screen is shown in Figure 2-17. Note that DLT0 is empty, while DLT1 is idle. When a drive is idle, it has a cartridge loaded, and is awaiting instructions. From the Default Screen, enter the Menu Mode by pressing the **Enter** button. The Main Menu shown in Figure 2-18 appears.





Figure 2-18 Main Menu



```
►Load/Unload
  Show Status Menu
  Maintenance Menu
  Configure Menu ↓
```

The ► is next to the line that reads 'Load/Unload.' Press the **Enter** button to display the first Load/Unload submenu, which is shown in Figure 2-19.

Figure 2-19 Load/Unload Initial Screen

```
From:
► DLT1
To:
 *Slot3 ↓
```

In Figure 2-19, the  is next to line 2 of the display. Line 2 shows the top item in a scrollable list of sources. Note that a  has appeared on the right of the bottom line. This indicates that the  button may now be used to scroll through the list, and that the top item on the list is displayed. As soon as you press the  button, three things happen:

1. The list scrolls down one item (only line 2 scrolls)
2. A  appears on the right of line 1 of the display. This indicates that there is one or more items above the item displayed on line 2.
3. The  at the left of line 2 disappears. This is because the * indicates the current selection or the default selection, and you have scrolled the default selection offscreen, and have not yet selected an item from the list.

NOTE

The contents of the lists on line 2 and line 4 will vary as follows.

Initial Screen - 'From' Line

The list on line 2 in Figure 2-19 (the 'From' line) will include every drive and every magazine slot that has a cartridge in it (you cannot get a cartridge from a slot or drive that is empty).

Initial Screen - 'To' Line

The list on line 4 of Figure 2-19 (the 'To' line) will include all of the valid destination choices, that is, drives and slots that are empty (you can't put a cartridge into a slot or drive which already has one in it.)

Scroll List - 'To' Line

There is another limitation on the 'To' list. If you have selected a drive on the 'From' screen, the 'To' list can include only slots. If you have selected a slot on the 'From' screen, the 'To' list can contain only drives.

Let us assume that you want to load the cartridge that is in Slot 4 into any available drive. Use the  button to scroll line two to Slot 4. The display appears as shown in Figure 2-20.

Figure 2-20 Load/Unload 'From' Entry Screen

```
From:
  ▶ slot4
To:
  *DLT1
```

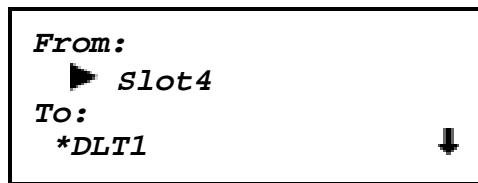

When you have scrolled to your desired source, press the **Enter** button to select it. Notice that in Figure 2-21, two changes occur in the display.

The * reappears at the beginning of line 2, indicating that you have made a selection.

The ▶ now moves to line 4, indicating that you may now select a destination.

Figure 2-21 Load/Unload 'To' Entry Screen

```
From:
  *Slot4
To:
  ▶*DLT0
```

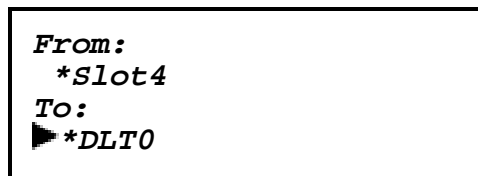

You can now simply press the **Enter** button to select DLT0 as the destination. Note that there is no ↓ at the end of line 4, nor ↑ at the end of line 1. There are no additional choices because 1) you have selected a slot as the source, so the destination must be a drive, and 2) DLT1 already has a cartridge in it, so it cannot be a valid destination. Press the **Enter** button to select DLT0. In response, the confirmation screen in Figure 2-22 appears.

Figure 2-22 Confirmation Screen

```
From: Slot4 To:DLT0
ENTER To Execute
ESCAPE To Cancel
```

As the confirmation screen indicates, to execute the load or unload, press the **Enter** button. If the confirmation screen does not show your intended source and destination, press the **Escape** button to return to the 'From' entry screen.

When you press the **Enter** button, the screen shown in Figure 2-23 appears. If the source is a drive, the word 'Unload' appears in place of 'Load' on line 4.

Figure 2-23 Load/Unload 'In Progress' Screen

```
From: Slot4 To:DLT0
Load In Progress
```

When the load or unload operation is finished, the Default Screen reappears. Note that in Figure 2-24, the screen has been updated to show that there is now a cartridge in DLT0, and Slot4 is empty.

Figure 2-24 Updated Default Screen

```
Dlt0 Idle
Dlt1 Idle
Loader Idle
0 1 2 3 _ 5 6 7 8 9
```

3

Regular Maintenance

This chapter describes the procedures for running/replacing the cleaning cartridge in the DLT MiniLibrary.

The only regular maintenance task that should be periodically performed is to run/replace the cleaning cartridge.

The Maintenance Menu offers the following options:

- Clean Drive
- Diagnostic Menu
- DemoMenu
- Flash Update
- Novram Update
- Clock Update
- Flash DLT
- Reboot Module

Of these, only **Clean Drive** and the **Demo Menu** are intended for the user. Flash Update may be performed by service personnel. Novram Update and Clock Update are used in factory setup, but these functions are duplicated by the options on the Configuration Submenu.

This chapter tells you how to clean the drives. The Diagnostic Menu and the Demo Menu are described in *Chapter 5 - Diagnostics and Troubleshooting*.

3.1 Cleaning Cartridge

The cleaning cartridge is similar in appearance to the cartridge shown in Figure 2-16, but is yellow in color. The command to run the cartridge is issued from the control panel. The procedures that follow tell you how to install a cleaning cartridge, how to clean a drive, and how to remove the cleaning cartridge.

CAUTION

The cleaning cartridge is abrasive, and should not be used unless the **Use Cleaner** LED comes on. To determine which drive requires cleaning on two-drive models, unload both drives and select 'Cleaning Needed' on the Drive Status submenu of the Show Status menu.

3.1.1 Installing a Cleaning Cartridge

1. Examine the Default Screen on the Control Panel to determine whether any cartridges are loaded into the drives. If so, then unload each as described in Chapter 2 - Operation.
2. Using the key provided (if necessary), unlock the Magazine Security Lock on the front panel.
3. Press the **Unlock/Open** Button on the front panel.
4. Remove the magazine from the Base Module.
5. Remove any cartridge present in Slot 0 (the slot farthest from the handle).
6. Insert the cleaning cartridge into Slot 0. You can use any slot, but using Slot 0 saves some keystrokes.
7. Press the **Unlock/Open** button on the front panel.
8. Insert the magazine into the Base Module.

3.1.2 Running the Cleaning Cartridge

This procedure assumes that the cleaning cartridge has been installed into Slot 0 of the magazine.

1. At the Default Screen, press the **Enter** button. The display will show the following.

Figure 3–1 Main Menu

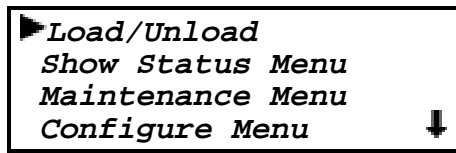

2. Press the **▼** button twice to move the **▶** next to **Maintenance**, then press the **Enter** button to select the Maintenance Menu. The display will show something similar to the following.

Figure 3–2 Maintenance Submenu



3. Press the **Enter** button once to select **Clean Drive**. The following screen appears.

Figure 3–3 Cleaning Submenu

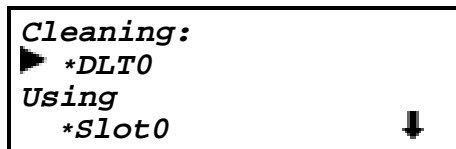

4. Lines 2 and 4 are scrollable. The choices available on Line 2 are DLT0, DLT1 and Both. Let us assume you want to clean DLT0. Press the Enter button once to accept DLT0. The **▶** moves to line 4 of the display. Press the Enter button again to use the cartridge in Slot 0. (If you cannot to use slot 0 for the cleaning cartridge, scroll to line 4 to select another slot).
5. The Cleaning Confirmation Screen appears, as shown below.

Figure 3–4 Cleaning Confirmation Screen

<i>Clean:</i>	<i>DLT0</i>
<i>Use:</i>	<i>Slot0</i>
<i>ENTER To Execute</i>	
<i>ESCAPE To Cancel</i>	

6. As the confirmation screen indicates, to execute the cleaning operation, press the **Enter** button. If the confirmation screen does not show your intended drive and cleaning cartridge, press the **Escape** button to return to the Cleaning submenu.

When you press the **Enter** button, the In Progress screen appears.

Figure 3–5 Cleaning In Progress Screen

<i>Clean:</i>	<i>DLT0</i>
<i>Use:</i>	<i>Slot0</i>
<i>Cleaning In Progress</i>	

When the cleaning operation is completed, the Default Screen reappears.

3.1.3 Removing the Cleaning Cartridge

NOTE

If the Base Module is installed in a sufficiently secure area, you may elect not to use the Magazine Security Lock. In that event, leave the lock in the unlocked position

1. Examine the Default Screen on the Control Panel to determine whether any cartridges are loaded into the drives. If so, then unload each using the Load/Unload Menu, as described in **Chapter 2 - Operation**.
2. Using the key provided (if necessary), Unlock the Magazine Security Lock on the front panel.
3. Press the **Unlock/Open** Button on the front panel.

4. Remove the magazine from the Base Module.
5. Remove the cleaning cartridge from the magazine.
6. Insert any desired data cartridge into the slot vacated by the cleaning cartridge.
7. Press the **Unlock/Open** Button on the front panel.
8. Insert the magazine into the Base Module.
9. Using the key provided, lock the Magazine Security Lock on the front panel (optional).

4

Configuration

This chapter describes how to customize configuration of the DLT MiniLibrary Base Module and defines configuration options.

The MiniLibrary Base Module is designed with several configuration options, each offering multiple settings to support a variety of applications and platforms. The setting of each option is stored in non-volatile memory in the module. For most applications, you will not need to change the factory default settings. If you need to change the configuration, go on to the next section. If you are uncertain whether you need to change a setting, contact your Technical Support representative.

To change settings, you need to use the **Control Panel**. For an overview of how the Control Panel works, and a description of the functions of the buttons, indicators and display, refer to the sections titled 'Entering the Menu Mode,' 'Exiting the Menu Mode,' and 'Navigating Through the Menu Structure' in *Chapter 2 - Operation*.

The settings can be changed using the procedure described below under "How to Customize Configuration." Before changing any configuration settings, consult your host system documentation to determine which settings may need to be changed.

4.1 How to Customize Configuration

1. Turn the module on, and wait until the **Power-On Self Test** terminates and the default screen appears on the display. Figure 4-1 shows a typical default screen. Yours may vary depending on the number of drives in your library (second line), and the number and locations of cartridges in the magazine (fourth line).

Figure 4-1 Default Screen

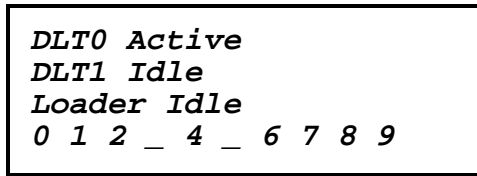

2. At the Default Screen, press the **Enter** button. The display will show the Main Menu, as in Figure 4-2.

Figure 4-2 Main Menu

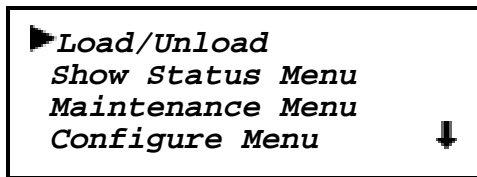

3. Press the ▼ button three times to move the ► to **Configure Menu**, then press the **Enter** button. The display will show the Configure submenu, as shown in Figure 4-3. The ↓ at the end of the fourth line means that there are additional configuration options that can be reached by scrolling with the ▼ button.

Figure 4-3 Configure Submenu

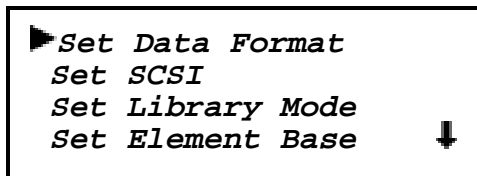

- To select a configuration option, press the ▲ or ▼ button on the control panel until the ► on the display is next to the option you want to change. In this case, let us choose Set Data Format. Press the **Enter** button to display the choices for that option. If your Base Module has two drives, the submenu in Figure 4-4 appears.

Figure 4-4 Drive Selection Submenu

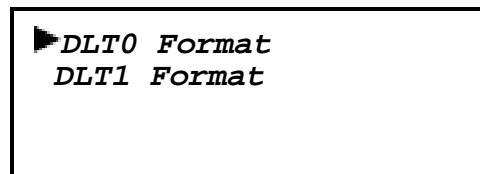

- Press the **Enter** button to select DLT0, or, to select DLT1, press the ▼ button to move the ► next to DLT1, then press the **Enter** button. A submenu for the Set Data Format option appears, as shown in figure 4-5.

Figure 4-5 DLT Set Data Format Submenu

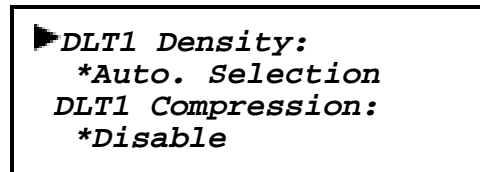

As shown in the submenu in Figure 4-5, the ► on the display is next to line 1, and line 2 is indented. This tells you that Figure 4-5 is a *two-tiered menu*. The ▲ and ▼ buttons work on two levels in this kind of menu, which is typical of many submenus of the Configure Menu. The first level is as follows: If you press the ▼ button, the ► moves to line 3. Pressing the ▼ button again has no effect. If you press the ▲ button, the ► moves back to line 1.

If you press the **Enter** button while the ► is next to line 1 (or line 3), the ▲ and ▼ buttons operate on the second level. You can tell because the ► moves next to line 2 (or line 4), and a ↓ appears at the end of line 4, indicating that there is a list of settings that can be scrolled using the ▲ and ▼ buttons.

Example:

To set the DLT1 Density would involve the following steps:

1. With the **▶** next to line 1, press the **Enter** button, moving the **▶** to line 2. Notice the **↓** appears at the end of line 4.
2. Use the **▲** and **▼** buttons to scroll line 2 to display the possible settings. After making your selection, press the **Enter** button to save the new selection. You can return to the screen in Figure 4-5 by pressing the **Escape** button. The **▶** returns to line 1.
3. This time, if you press the **▼** button instead of the **Enter** button, the **▶** moves to line 3, allowing you to set DLT1 Compression.
4. Press the **Escape** button repeatedly until the submenu in Figure 4-4 reappears.
5. Repeat this procedure for each configuration option you want to change.

4.2 Descriptions of Configuration Options

The items available on the Configuration Menu are as follows:

4.2.1 Set Data Format

This option enables you to specify DLT data *Density* and DLT data *Compression* requirements. The default for both options is Auto Selection (this will not affect the default operation of the TZ89N Tape Drive).

4.2.2 Set SCSI

This option enables you to 1) enable or disable the library robotics SCSI bus parity checking, and 2) set the SCSI addresses of the drives and the library robotics. The defaults are: parity on; DLT 0 address = 4; DLT 1 address = 5, robotics address = 0.

4.2.3 Set Library Mode

This option enables you to set the library robotics operating mode to Random, Sequential DLT0, Sequential DLT1, or Sequential Split. Random is the normal operating mode which affords complete host control of the library robotics. The Sequential modes are locally controlled modes. Sequential DLT0 begins with any cartridge loaded into DLT0. The Base Module monitors the status of DLT0, and when the cartridge is unloaded by the host, it loads the next cartridge in magazine numerical order. This operation continues to cycle until all of the cartridges have been loaded. Sequential DLT1 is the same, except that the cartridges are loaded into DLT1. Sequential Split mode provides two simultaneous sequential modes. Cartridges 0 through 4 are loaded sequentially into DLT0; cartridges 5 through 9 are loaded sequentially into DLT1.

4.2.3.1 Set Sequential Configuration

NOTE

Sequential Split mode requires two drives. The default is Random.

To operate the TL891 in Sequential Mode, the following configuration parameters must be established:

- **Library Mode**- change from Random (default) to Sequential DLT0.
- **Sequential Mode** must remain at *Normal* (default).
- **Test Unit Ready (TUR)** - change from Standard (default) to Custom.

To establish these parameters for Sequential Mode operation, proceed as follows:

1. From the Default Menu press **Enter**. The Main Menu appears (Figure 4-6)

Figure 4-6 Main Menu

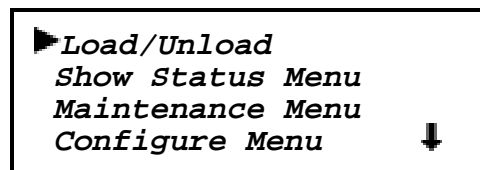

2. Press ▼ three times so that the ▶ is next to Configure Menu and press **Enter**. The Configure Submenu will appear as shown in Figure4-7.

Figure 4-7 Configure Submenu

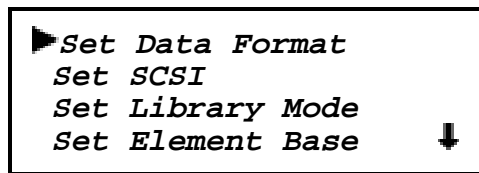

3. Press ▼ twice so that the ▶ is next to **Set Library Mode** and press **Enter**. The Library Mode Selection Menu will appear as shown in Figure 4-8.

Figure 4-8 Library Mode Selection Menu

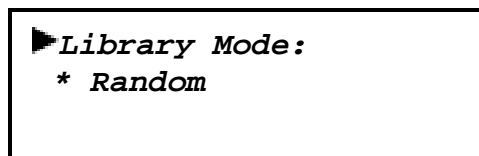

4. Press **Enter** again so the ▶ is next to *Random.

The Library Mode options are:

For a TL891 -

- Random
- Sequential DLTO

For a TL892 -

- Random
- Sequential DLTO
- Sequential DLT1
- Sequential Split

Press the ▼ button to display the desired *Sequential* option and select it by pressing **Enter**. The Sequential Mode options *Normal* and *Recirculate* will appear. To select Normal which is the default (and recommended) setting, press **Enter**.

- To set the **TUR Reporting option** - press the **Escape** key to move up one level to the Configure Submenu (Figure 4-9) and use the **▼** arrow to move the **▶** to *Set Special Config* (**11th menu item from top**) and press **Enter**.

Figure 4-9 Configure Submenu

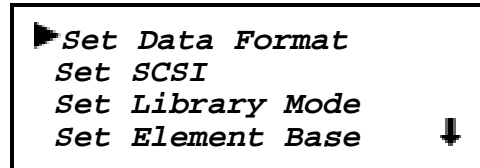

The front panel will display the Special Config Submenu (Figure 4-10).

Figure 4-10 Special Config Submenu

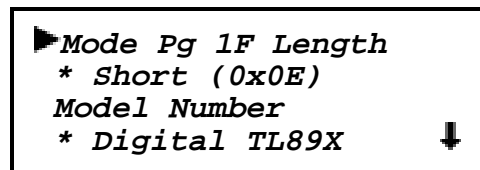

Press **▼** twice to position the **▶** next to the TUR Reporting option. Press **Enter** to move **▶** down one line to ***Standard**. Use the **▼** to change to **Custom** and press **Enter** to accept this setting. To return the module to online status, press **Escape** three times.

4.2.4 Set Element Base

This option allows you to set the base addresses of each of the three SCSI *elements* of the module. In order to identify sources and destinations in commands to the robotics, the base module is divided into elements, each of which is assigned a separate designator or *element address*. The *Transport Element* is the robotics mechanism itself; the *Storage Elements* are the 10 slots in the magazine; the *Transfer Elements* are the drives. The Base Module reports these settings in response to the SCSI Mode Sense command, in the Element Address Assignment Page. The defaults are Transport = 0000h; Storage element base = 0001h, Transfer element base = 00F0h.

4.2.5 Set Date

Enables you to set the module's calendar.

Table 4-1 summarizes the configuration settings for the DLT Mini-Library Base Module. The default settings are shown in the third column. Other possible settings are shown in the second column.

Table 4-1 Mini-Library Configuration Options

Option	Settings	Default
Data Format	Density: THZ01, THZ02, DLT2000, DLT2000XT, DLT4000, Auto Compression: Enable, Disable (Enable at 10.0 only)	Auto Selection Auto Selection
SCSI	Lib Bus Parity: Enable, Disable Lib Bus ID: (SCSI ID) DLT0 Bus ID: (SCSI ID) DLT1 Bus ID: (SCSI ID)	Enabled 0 4 5
Library Mode	Random, Seq. DLT0, Seq. DLT1, Seq. Split	Random
Element Base	Transport: NNNN (hex) Storage: NNNN (hex) Transfer: NNNN (hex)	0000 0001 00F0
Identification	Vendor ID: DEC Product ID:	DEC TL800
Date	DD, MMM, YYYY	Current date
Time	HH, MM	Current Time
Baud Rate		38400
Serial Number	NXNNNNNNNN	XXXXXXXXXX
Unload Mode	Implicit Explicit	Implicit
Negotiation	Initiate Do Not Initiate	Do Not Initiate

Continued next page

Table 4-1 Mini-Library Configuration Options - (continued)

SPECIAL CONFIGURATION OPTIONS		
Option	Settings	Default
Mode Page 1F Length	Short (0 x 0E) Long (0 x 12)	Short
Model Number	Overland LXnn DIGITAL TL89x <Vendor Unique>	DIGITAL TL89x
TUR Reporting	Standard Custom	Standard
Init Element Status	No Inventory Force Inventory Force Label Scan	No Inventory
Unit Attn Report	All One	All
Alternate Config	Stand alone Slave	Stand alone
Element Base	Zero based One based	Zero based
Label Size	8 char...1 char	8 character
Label Alignment	Left Align Right Align	Left Align
Default	Resets all options to defaults. Data and Time remain current	

4.2.6 Set Time

Enables you to set the module's clock.

4.2.7 Set Baud Rate

Enables you to set the data transmission rate of the module's trace port. This function is intended for use by CEs only. The default is 38400 bits/sec.

4.2.8 Set Serial Number

This option enables you to alter the Base Module's serial number as stored in the unit. The Base Module's robotics reports these settings in response to the SCSI Inquiry command, in the Unit Serial Number Page.

4.2.9 Set Unload Mode

This option determines whether a SCSI Move Medium command is interpreted as implicit or explicit. If implicit, when the module receives a SCSI Move Medium command for a fetch from a drive, it unloads the drive before attempting to fetch a cartridge from that drive. If explicit, the host must issue a SCSI Unload command before each Move Medium command where the source element is a drive. The default is Implicit.

4.2.10 Set Negotiation

This option allows the Base Module to initiate negotiations for synchronous data transfer and wide data transfer from the host. Only models with a fast/wide drive installed can initiate a 'wide' negotiation. The default is Do Not Initiate.

4.2.11 Set Special Configuration

This option contains predefined Digital operational configurations. Refer to the "Special Configuration Options" section within Table 4-1 for default configuration characteristics

4.2.12 Set Default

This option resets all of the preceding configuration options to their factory defaults, excepting Date and Time, which remain at their current settings.

Diagnostics and Troubleshooting

This chapter describes the procedures for diagnosing platform problems and drive errors which can cause the DLT MiniLibrary to malfunction. It also provides Fault Symptom Codes and Error Recovery Procedures to help restore operability.

5.1 Diagnosing Problems

There are two main types of problems that can cause the DLT MiniLibrary to malfunction or fail to perform correctly: platform problems and general drive errors. Some errors cause Fault Symptom Codes (FSC) to be displayed on the control panel, along with a description of the fault. Error Recovery Procedures (ERP) are available for each FSC. They are described in this chapter.

5.1.1 Platform Problems:

These errors arise out of incorrect installation and configuration. The most common characteristic of this type of error is that the drive appears to operate normally, except that no data can be interchanged. You may not get an error code on the control panel. To identify an error as this type of problem, check your installation and configuration setup, referring back to **Chapter 4 - Configuration** and **Appendix B - Installation**

5.1.2 General Drive Errors

These errors usually result from a miscommunication between the drive processors or involve a mechanical malfunction. In most cases, these types of errors report an error message and an FSC to the control panel. The only exceptions are power supply problems and display malfunctions. The FSC can be used to determine a recovery procedure.

Some error messages can be cleared by pressing the **ENTER** button on the control panel, others by cycling the power to the library. Often the module will resume normal operation. Other errors are repeated when the operation is attempted again. Such recurrent errors may require more extensive recovery procedures such as replacement of a part.

To aid you in localizing persistent errors, there are CE diagnostics available in the Maintenance Submenu and a user diagnostic available on the Demo Submenu. The diagnostics are described at the end of this chapter.

5.2 Error Recovery

Figure 5-1 is a flow chart that outlines the recommended steps for error recovery. This chart should be followed in all cases.

Error Recovery Procedures (ERP) are described in detail in Table 5-1. Fault Symptom Codes are listed in Table 5-2.

Figure 5-1 Troubleshooting Flow Chart

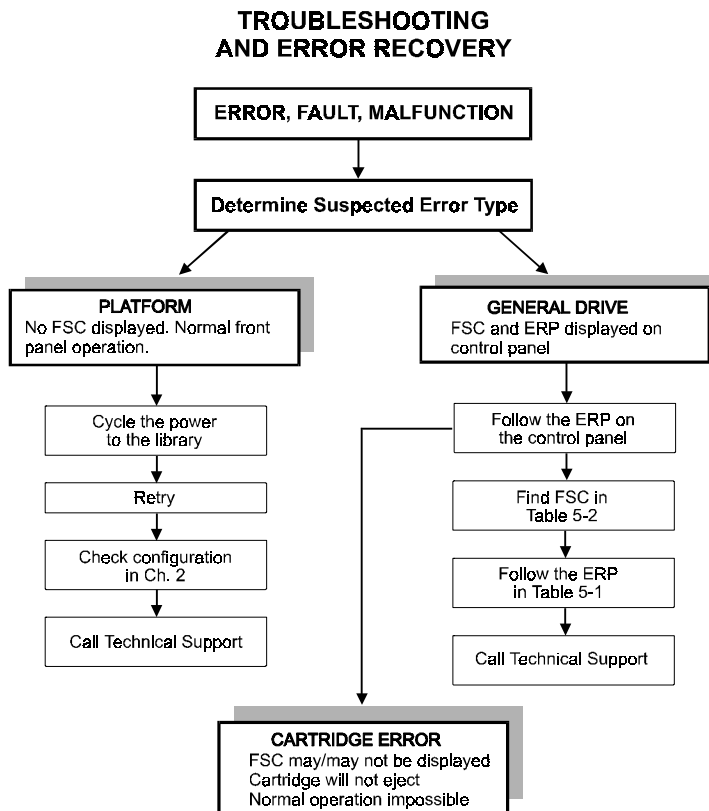

5.2.1 Error Recovery Procedures

Table 5-1 gives error recovery instructions for errors reported on the front panel. This list includes procedures that should only be performed by a qualified service technician.

Table 5–1 Error Recovery Procedures

ERP NUMBER	PROCEDURE DETAIL
A	Run the cleaning cartridge. See Chapter 3 - Regular Maintenance
B	Change the cartridge. It may be damaged or incorrectly formatted.
B3	Inspect cartridge. Check for damage and leader alignment. See Chapter 2 - Operation, Tape Requirements.
B4	Disable cartridge write-protect switch.
C	Cycle power to the drive using the AC switch on the front panel of the module. Wait 30 seconds to power on again.
D	Turn off power to the module and inspect connectors and cables.
D1	Turn off power to the module and check cabling to the DLT drives. Inspect the cables and connectors.
D2	Check cabling and configuration. See Chapter 4 - Configuration., and Appendix B - Installation.
E(x)	Run Diagnostic (x).
F	Invalid operation. Select parameters correctly and try again.
G	Call Technical Support.

5.3 Fault Symptom Codes (FSC)

Fault Symptom Codes appear in the Fault Screen described in Chapter 2. Each FSC is accompanied by a descriptive message and instructions for clearing the fault. When a fault persists, the operator should look up the FSC in Table 5-2 to determine the error recovery procedure to be followed. If you call DIGITAL Technical Support about a fault condition, be sure to furnish the FSC to aid in identifying the problem.

Table 5-2 Fault Symptom Codes

FSC	Message	ERP
0101	Unused Interrupt Power Down To Clear	D, G
0102	Enqueue'g a Null Ptr Power Down To Clear	D, G
0201	Trc Comm Open Error Power Down To Clear	D, G
0301	Novram Init Error Power Down To Clear	D, G
0302	Novram Chksum Error Press Enter To Init Novram To Def Config	G
0303	Novram Program Error Power Down To Clear	D, G
0304	Novram Downld Error Press Enter To Clear	D, G
0305	Novram Data Error Press Enter To Clear	D, G
0306	Novram Update Error Power Down To Clear	D, G
0401	Invalid Display Char Press Enter To Clear	D, G
0402	Invalid Display Line Press Enter To Clear	D, G

Continued Next Page

Table 5–2 Fault Symptom Codes (continued)

FSC	Message	ERP
0501	Barcode Comm Error Power Down To Clear	D, G
0601	Clock Init Error Power Down To Clear	D, G
0602	LP-RAM Init Error Power Down To Clear	D, G
0603	Clock Download Error Press Enter To Clear	
0701	Slv Comm Open Error Press Enter To Clear	D, G
1001	SCSI Firmware Error Press Enter To Clear	D, G
1002	SSCI FIFO Empty Press Enter To Clear	D, G
1003	SSCI FIFO Error Press Enter To Clear	D, G
1004	SSCI Gross Error Press Enter To Clear	D, G
1005	SSCI Illegal Command Press Enter To Clear	D, G
1006	SSCI Message Error Press Enter To Clear	D, G
1007	SSCI Invalid Element Press Enter To Clear	D, G
1008	SSCI No Pending Int Press Enter To Clear	D, G
1009	SSCI Invalid Int Press Enter To Clear	D, G
1020	No Active Command Press Enter To Clear	D, G

Continued Next Page

Table 5–2 Fault Symptom Codes (continued)

FSC	Message	ERP
1021	SCSI Invalid Request Press Enter To Clear	D, G
1022	SCSIInvalidSemaphore Press Enter To Clear	D, G
1023	SCSI Invalid State Press Enter To Clear	D, G
1024	SCSI Invalid Ctl Msg Press Enter To Clear	D, G
1025	Overlapped Ctl Cmds Press Enter To Clear	D, G
1026	Overlapped Ctl Msgs Press EnterTo Clear	D, G
2001	Ctl Invalid Command Press Enter To Clear	D, G
2003	Invalid Drive State Press Enter To Clear	D, G
2004	Loader Not Ready Press Enter To Clear	D, G
2005	SCSI Id Not Set Press Enter To Clear	D1, G
2006	DLT Comm Open Error Power Down To Clear	D1, G
2008	Illegal Move Press Enter To Clear	C1, C, D, G
2009	Door Open Press Enter To Clear	
200A	Menu Mode Press EnterTo Clear	
200C	Cart Unaccessible Press Enter To Clear	

Continued Next Page

Table 5–2 Fault Symptom Codes (continued)

FSC	Message	ERP
2010	Ctl Firmware Error Press Enter To Clear	
2011	Ctl Firmware Error Press Enter To Clear	
2012	Ctl Firmware Error Press Enter To Clear	
2013	Ctl Firmware Error Press Enter To Clear	
2014	Ctl Firmware Error Press Enter To Clear	
2015	Ctl Firmware Error Press Enter To Clear	
2016	Ctl Firmware Error Press Enter To Clear	
2030	DLT Timeout Error Power Down To Clear	
2031	DLT Timeout Error Power Down To Clear	
2021	DLT Timeout Error Power Down To Clear	
2033	DLT Timeout Error Power Down To Clear	
2034	DLT Timeout Error Power Down To Clear	
2040	Invalid Ctl Message Power Down To Clear	
2041	Invalid Ctl Message Power Down To Clear	
2042	Invalid Ctl Message Power Down To Clear	

Continued Next Page

Table 5–2 Fault Symptom Codes (continued)

FSC	Message	ERP
2043	Invalid Ctl Message Power Down To Clear	
2050	No Free Queues Power Down To Clear	
2051	No Free Queues Power Down To Clear	
2052	No Free Queues Power Down To Clear	
2053	No Free Queues Power Down To Clear	
2054	No Free Queues Power Down To Clear	
3001	Picker Retries Excd Power Down To Clear	
3002	Picker Tach Errors Power Down To Clear	D, G
3003	Elevator Tach Errors Power Down To Clear	D, G
3007	DLT Timeout Error Power Down To Clear	D1, G
3008	Invalid Drive State Power Down To Clear	D1, G
3009	Door Tach Errors Power Down To Clear	C1, C, D, G
300A	Door Fault Power Down To Clear	C1, C, D1, G
300B	Elev Open Tach Power Down To Clear	
300C	Picker Open Tach Power Down To Clear	

Continued Next Page

Table 5–2 Fault Symptom Codes (continued)

FSC	Message	ERP
300D	Door Open Tach Power Down To Clear	
300E	Drive Stow Error Power Down To Clear	
3010	Picker Retries Excd Power Down To Clear	
3011	Picker Retries Excd Power Down To Clear	
3012	Picker Retries Excd Power Down To Clear	
3013	Picker Retries Excd Power Down To Clear	
3014	Picker Retries Excd Power Down To Clear	
3040	Motor Firmware Error Power Down To Clear	
3041	Motor Firmware Error	
3042	Motor Firmware Error	
3100	Picker Jammed Power Down To Clear	
3101		
3102	Picker Jammed Power Down To Clear	
3103	Picker Jammed Power Down To Clear	
3104	Picker Jammed Power Down To Clear	

Continued Next Page

Table 5–2 Fault Symptom Codes (continued)

FSC	Message	ERP
3105	Picker Jammed Power Down To Clear	
3106	Picker Jammed Power Down To Clear	
3107	Picker Jammed Power Down To Clear	
3108	Picker Jammed Power Down To Clear	
3109	Picker Jammed Power Down To Clear	
310A	Picker Jammed Power Down To Clear	
310B	Picker Jammed Power Down To Clear	
3200	Elevator Jammed Power Down To Clear	
3201	Picker Jammed Power Down To Clear	
3202	Picker Jammed Power Down To Clear	
3203	Picker Jammed Power Down To Clear	
3204	Picker Jammed Power Down To Clear	
3205	Picker Jammed Power Down To Clear	
4001	ROM Crc Error Power Down To Clear	D, G

Continued Next Page

Table 5–2 Fault Symptom Codes (continued)

FSC	Message	ERP
4002	Ram Test Failed Power Down To Clear	D, G
4003	Xilinx Progr Error Power Down To Clear	D, G
4010	Comm UART Error Power Down To Clear	D, G
4011	Trace UART Error Power Down To Clear	D, G
4012	Barcode UART Error Power Down To Clear	D, G
4013	DLT 0 UART Error Power Down To Clear	D1, D,, G
4014	DLT 1 UART Error Power Down To Clear	D1, D, G
5001	No DLTs Attached Press Enter To Clear	F
5002	All DLTs/Slots Empty Press Enter To Clear	F
5003	All DLTs/Slots Full Press Enter To Clear	F
5010	No DLTs Attached Press Enter To Clear	F
5011	All Slots Empty Press Enter To Clear	F
5012	All DLTs Full Press Enter To Clear	F
5013	DLT Timeout Error Press Enter To Clear	F

Continued Next Page

Table 5–2 Fault Symptom Codes (continued)

FSC	Message	ERP
5014	DLT Already Loaded Press Enter To Clear	F
5015	Expired Clean'g Cart Press Enter To Clear	
5016	Not a Clean'g Cart Press Enter To Clear	
5020	All DLTs/Slots Empty Press Enter To Clear	F
5030	Bad Novram Setting Press Enter To Clear	
5031	Bad Calendar Setting Press Enter To Clear	
5032	Bad Setting Press Enter To Clear	
5033	Set Density Failed Press Enter To Clear	
5034	Set Compress Failed Press Enter To Clear	
6001	Comm Open Error Power Down To Clear	D, G
6002	Comm Port Send Error Press Enter To Clear	
6003	Comm Port Recv Error Press Enter To Clear	
6010	Pkt Send Error Power Down To Clear	D, G
6011	Pkt Receive Error Power Down To Clear	D, G

Continued Next Page

Table 5–2 Fault Symptom Codes (continued)

FSC	Message	ERP
6012	Status Unexpected Power Down To Clear	D, G
6013	Invalid Com Blk Type Power Down To Clear	
6014	Invalid Com Blk Type Power Down To Clear	
6015	Ack Timeout - Out Power Down To Clear	
6016	Ack Timeout - In Power Down To Clear	
6017	Ack Invalid - Out Power Down To Clear	
6018	Ack Invalid - In Power Down To Clear	
6019	Comm Port Ack Error Power Down To Clear	
6020	Command Overlap Power Down To Clear	
6021	Slave Rts Still Set Power Down To Clear	
6022	Slave Addr Invalid Power Down To Clear	
6023	Slave Req Unkmown Power Down To Clear	
6024	Slave Has No Pkts Power Down To Clear	
6040	Pkt Send Error Power DOWN TO CLEAR	

Continued Next Page

Table 5–2 Fault Symptom Codes (continued)

FSC	Message	ERP
6041	Pkt Receive Error Power Down To Clear	
6042	Status Unexpected Power Down To Clear	
6043	Invalid Com Blk Type Power Down To Clear	
6044	Invalid Com Blk Type Power Down To Clear	
6045	Command Overlap Power Down To Clear	
6046	No Pkts To Send Power Down To Clear	
6047	Invalid Direction Power Down To Clear	
B001	Boot ROM CRC Error Power Down To Clear	
B002	Boot RAM Test Failed Power Down To Clear	
B003	Boot UART Error Power Down To Clear	
B004	Boot Comm Open Error Power Down To Clear	
B005	Boot Novram Error Power Down To Clear	
B006	Boot Unused Int Power Down To Clear	
B007	Flash Init Error Power Down To Clear	

Continued Next Page

Table 5–2 Fault Symptom Codes (continued)

FSC	Message	ERP
F001	No Flash Installed Press Enter To Clear	
F002	Invalid Comm Port Press Enter To Clear	
F003	Could Not Open Comm Press Enter To Clear	
F004	Host Sync Failed Press Enter To Clear	
F005	Invalid H/W Config Press Enter To Clear	
F006	Incompatible Image Press Enter To Clear	
F010	Flash Erase Error Power Down To Clear	
F011	Flash Download Error Power Down To Clear	
F012	Flash Program Error Power Down To Clear	
F013	Flash CRC Error Power Down To Clear	

End FSC Table

5.4 Using CE Diagnostics

The system diagnostics are intended for use by a CE or other technically trained person. To use system diagnostics, proceed as follows.

1. At the **Default Screen**, press the **Enter** button. The display will show the following.

Figure 5-2 Main Menu

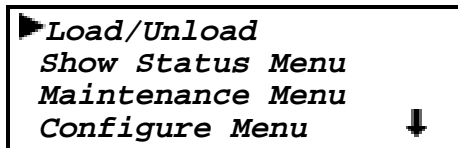

2. Press the ▼ button twice to move the ► next to **Maintenance**, then press the **Enter** button to select the *Maintenance Menu*. The display will show something similar to the following.

Figure 5-3 Maintenance Submenu

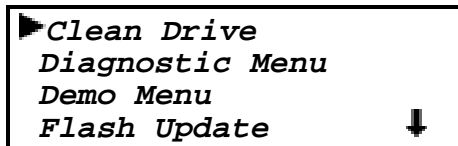

3. Press the ▼ button once to move the ► next to **Diagnostic Menu**, then press the **Enter** button to select the *Diagnostic Menu*. The following menu will appear.

Figure 5-4 Diagnostic Submenu

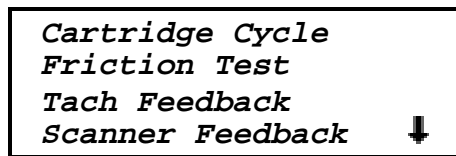

This screen is scrollable. The list of Diagnostics available is as follows.

- Cartridge Cycle
- Friction Test
- Tach Feedback
- Scanner Feedback

Of these selections, only **Cartridge Cycle** is intended for use in the field. The remaining tests are used during factory setup.

5.4.1 Cartridge Cycle Diagnostic

When you select *Cartridge Cycle*, the library robotics begin to move cartridges randomly from slot to slot in the magazine, while reporting on the front panel the number of passes.

This diagnostic will run continuously as long as the Base Module has power. To stop the test, press the **Escape** button. A flashing message appears on the display telling you that the test is paused. Pressing the **Escape** button a second time terminates the diagnostic and returns to the Maintenance Menu.

5.5 Using the Demo Submenu

The only User Diagnostic is found on the Demo submenu on the Maintenance Menu. The submenu lists five demos, numbered 1 through 5. At present, only Demo 1 is implemented. Demo 1 enables the user to fully exercise the library robotics.

When you select Demo 1, the library robotics begin to move cartridges randomly from slot to slot in the magazine, while reporting on the front panel the number of passes. If all ten slots in the magazine are full, Demo 1 will load a cartridge into DLT0 and leave it there. If you press the ▲ button while Demo 1 is running, the system will load a cartridge into DLT0, unless DLT0 is full. If you press the ▲ button again, the cartridge is unloaded from DLT0 and returned to the magazine. The ▼ button causes DLT1 to be loaded and unloaded in the same way.

Demo 1 will run continuously as long as the Base Module has power. To stop the test, press the **Escape** button. A flashing message appears on the display telling you that the test is paused. Pressing the **Escape** button a second time terminates Demo 1 and returns to the Maintenance Menu.



Specifications

This appendix provides the technical specifications for the DLT MiniLibrary Base Module.

Operational Performance Specifications

Host Interface.....	SCSI-2
Number of Cartridges, Full Magazine.....	10
Media type	
TL891 and TL892	CompacTape III, IIIXT, or IV
Number of Drives.....	1 or 2
Cartridge Transfer Load Time	10 sec (max.), including picking from slot
Cartridge Transfer Unload Time.....	10 sec (max.), including returning to slot
Rewind Time.....	45 sec (avg.)
Module Native Data Capacity (Full Magazine):	
CompacTape IV	350 GB/700 GB

Reliability Specifications (Drives)

Mean cycles between operator intervention	150,000
Data Error Rate	1 in 10 ¹⁵ bytes (?)
MTBF	280,000 hrs (unlimited duty cycle)
MTTR	15 min
Head Life	30,000 tape motion hrs
Design Life	5 years @ 3,300 power-on hrs/year

Reliability Specifications (Library Robotics)

Mean Cartridges Before Failure 500,000
Design Life Five years

Power Specifications

Voltage 100-240 VAC
Amperage 1.2-0.5 A
Line Frequency 50-60 Hertz

Mechanical Specifications

Height 6.97 in. (17.70 cm.)
Width 17.00 in. (43.18 cm.)
Depth
 overall 23.75 in. (60.35 cm.)
 behind panel 22.50 in. (57.15 cm.)
Weight
 dual drive 62 lbs. (28.18 kg.)
 single drive 48 lbs. (21.8 kg.)
Shipping Weight
 dual drive 70 lbs. (31.81 kg.)
 single drive 56 lbs. (25.45 kg.)

Environmental Specifications

Operating

Dry Bulb Temp. 50°F to 104°F (10°C to 40°C)
Temperature Gradient 1.8°F/min. (1°C/min.)
Temperature Shock 59°F (15°C) over 2 min.
Wet Bulb Temperature 78.8°F (26°C)
Relative Humidity non-condensing 15% to 85%
Humidity Gradient 10%/hour
Altitude -100 ft. to +10,000 ft (-305m to 3050m)

Non-Operating (Packed or Unpacked)

Dry Bulb Temp.	-40°F to 140°F (-40°C to 60°C)
Temp. Gradient	36°F (20°C)/hour (across the range)
Temperature Shock	27°F (15°C) (over 2 min.)
Wet Bulb Temp.....	86°F (30°C)
Relative Humidity _{non-condensing}	10% to 95%
Humidity Gradient	10%/hour
Altitude	-100 to +10,000 ft. (-305 to 3050m)

Storage/Transit

Dry Bulb Temp.	-40°F to 140°F (-40°C to 60°C)
Temp. Gradient	45°F (25°C)/hour (across the range)
Temperature Shock	27°F (15°C) (over 2 min.)
Wet Bulb Temp.....	86°F (30°C)
Relative Humidity _{non-condensing}	5% to 95%
Humidity Gradient	10%/hour
Altitude	-100 to +10,000 ft. (-305 to 15,250m)

Acoustic Emissions

Drive Condition.....	Emission Level
Both drives operating	<50 dBA
(Intermittent robot motion excepted)	

Safety

The TL89x carry the following Regulatory Agency product safety certifications:

Certification	Standard
UL Listed.....	UL 1950
TUV/Product Service	EN 60 950 GS Mark
CE Mark	EMC Directive
.....	Low Voltage Directive
Canadian UL Listed	CSA 22.2 No. 950

**Table A-1 Acoustic Noise Declaration for German Noise Declaration Labor:
Declared Values per ISO 9296 and ISO 7779**

Product	Sound Power Level		Sound Pressure Level	
	L_{WA} , B		L_{pAm} , dBA (bystander position)	
	Idle	Operate	Idle	Operate
-TL892-	6.0	6.0	48	48

NOTE

Current values for specific configurations are available from Digital representatives.
1 B = 10 dBA.

Table A-2 Schallemissionswerte - Werteangaben nach ISO 9296 und ISO 7779 /DIN EN27779:

Gerät	Schalleistungspegel		Schalldruckpegel	
	L_{WA} , B		L_{pAm} , dBA (Bediener position)	
	Leerlauf	Betrieb	Leerlauf	Betrieb
-TL892-	6.0	6.0	48	48

HINWEIS

Aktuelle Werte für spezielle Ausrüstungsstufen sind über die Digital Equipment Vertretungen erhältlich. 1 B = 10 dBA.

Electromagnetic Emission

Notice

This equipment has been tested using double shielded cables for EMI compliance. The use of unshielded cables or modifications requires system testing for EMI testing for compliance to the standard.

Industry Canada / Industrie Canada

This Class A digital apparatus meets all requirements of the Canadian Interference-causing Equipment regulations.

Cet appareil numérique de la classe A respecte toutes les exigences du Règlement sur le matériel brouilleur du Canada.

FCC Notice

This equipment has been tested and found to comply with the limits for a Class A digital device, pursuant to Part 15 of the FCC rules. These limits are designed to provide reasonable protection against harmful interference when the equipment is operated in a commercial environment. This equipment generates, uses and can radiate radio frequency energy and, if not installed and used in accordance with the instruction manual, may cause harmful interference to radio communications. Operation of this equipment in a residential area is likely to cause harmful interference in which case the user will be required to correct the interference at their own expense.



Installation

*There are three major steps to complete installation of the DLT MiniLibrary Base Module: Mechanical Installation, Cabling and Configuration. This appendix deals with the first two. Configuration, which consists of using the Configure Menu to customize the configuration options to your particular application, is described in **Chapter 4 - Configuration**.*

B.1 Mechanical Installation

The Base Module can be installed on a desktop or rackmounted in either a standard 19" EIA/RETMA rack (with a depth of 24-30") or a Storageworks Metric rack using metric conversion brackets.

Desktop Installation - No mechanical installation is required. Follow the directions in the shipping container to unpack the module and place it in the desired physical location (must be a stable, horizontal surface with at least a 2" clearance behind it to allow a free flow of cooling air from the fan). Save the packing materials for re-use in case you need to return the module for repairs.

Rackmount Installation - Mechanical installation varies slightly depending on the type of rack used. Both rack types (standard and metric) require the initial steps of *separating the rack-slides* and *attaching the mounting-brackets*. The procedures which follow first describe these *common* rackmount instructions, followed by *rack-specific* rackmount instructions, and then common cabling and configuration procedures in section B.2.

Follow the directions in the shipping container to unpack the module. Save the packing materials for re-use in case you need to return the module for repairs.

The base module comes with a slide rack set installed on either side. The slide is attached to the Base Module enclosure by means of three screws through the inner slide. Remove the packing tape from the slides, and separate each set of slides as follows:

Rack Slide Separation:

1. (Refer to Figure B-1). Pull the outer slide toward the rear, along with the intermediate slide until the inner slide lock engages the intermediate slide.
2. Continue to pull the outer slide towards the rear until the outer slide lock engages the intermediate slide. Press down on the inner slide lock to permit the intermediate slide to continue to move toward the rear. Continue to move the outer and intermediate slides toward the rear until they are separated from the inner slide.

Figure B-1 Separating a Rack Slide

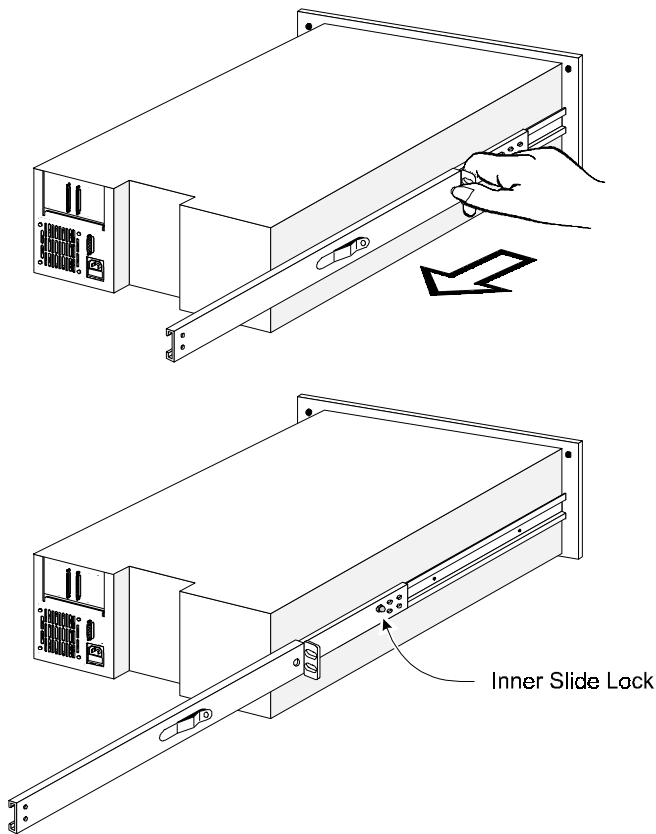

3. Identify and orient the parts of the slides and hardware needed for your specific rack type. Figure B-2 shows the parts required for Standard EIA/RETMA rackmounting and Figure B-3 shows the parts for rackmounting into a Storageworks metric rack.

NOTES:

All of the screws, washers, nutplates and/or metric conversion brackets required for rackmounting in either cabinet type are supplied with the Base Module. You will need a #2 Phillips screwdriver and a flathead screwdriver.

The left and right slides are alike, so there is no risk of confusing the parts on reassembly.

The *front of the cabinet*, and *front rails* in this text refers to where the *module face* will be exposed (typically opposite from the main power source location). The main power source location thus becomes the *rear of the cabinet*, and where the *rear rails* exist.

4. Loosely assemble a mounting bracket to each outer slide, using two 10-32 screws with washers and a nutplate for each. Select slots in the mounting brackets so the length of the assembly equals the distance between the front and rear rails of the rack.
5. Locate the screw holes in the front and rear rails of the cabinet or equipment rack where the drive is to be installed.

CAUTION!

The cooling fan at the rear of the drive must not be obstructed when the drive is installed in the rack. It is advisable to allow two inches of clearance behind the rear panel of the module.

6. From this point, the instructions vary depending on cabinet type, and you should proceed as follows:
 - **EIA/RETMA Cabinet Rackmounting - Refer to Section B.1.1.**
 - **StorageWorks Metric Rackmounting - Refer to Section B.1.2.**

B.1.1 Rackmounting in a Standard (19") EIA/RETMA Cabinet:

These procedures assume that you have already separated the slide racks and attached the mounting brackets to the slides as described in the beginning of this chapter. Next:

1. Fasten each outer slide behind the front rail of the rack using two 10-32 **low-profile** screws with washers and one nut plate. Two 10-32 clip nuts are provided to engage the captive screws on the front panel.
2. Fasten each of the mounting brackets to the front of the rear rail of the rack using two 10-32 screws and one nut plate.
3. Tighten the screws installed in step 4.
4. If they are not already locked, pull the intermediate slides toward the front (out of the rack) so that they lock in the extended position.

Figure B-2 Rack Slide Parts for Standard 19" EIA/RETMA Rackmounting

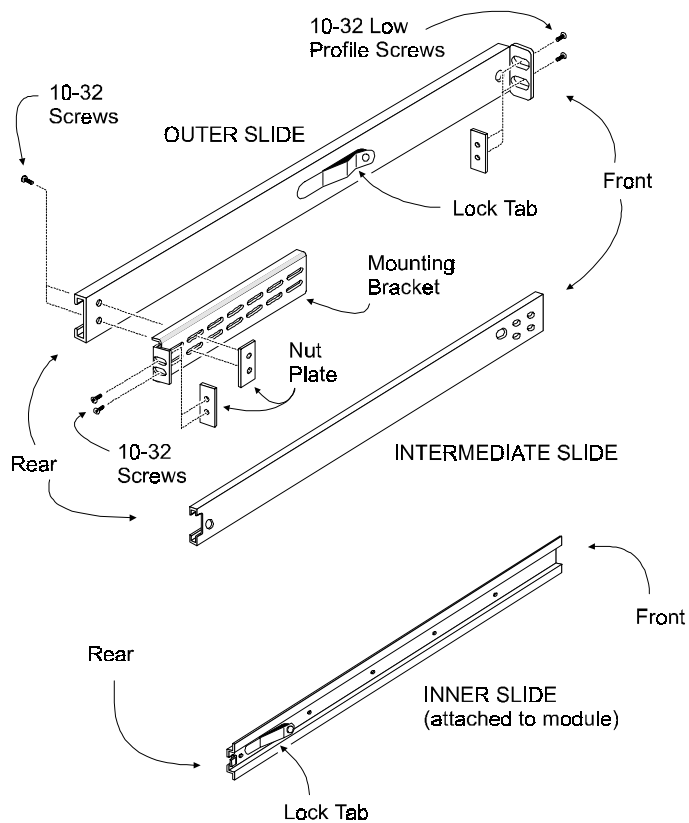

NOTE

Step 9 should be performed by two people.

CAUTION!

Make certain that when the module is fully extended that a force of 20% of the rack weight, but not more than 57 lb. Applied in any direction but upwards does not cause the rack to overbalance.

9. In front of the rack, lift the module to its installed height. Engage the inner slides mounted on the module with the intermediate slides protruding from the rack, and slide the module toward the rack until the inner slide lock engages the intermediate slide. This leaves the entire module protruding from the rack, locked in position, supported by slides.
10. Press inward (toward the module) on each of the inner slide locks to permit the intermediate slides to move toward the rack.
11. Slide the module in and out several times, ensuring that the inner and outer slide locks engage, and that the module does not bind against the slides.
12. If binding occurs, loosen the four screws that secure the slides to the front rails and the four screws that secure the slides to the rear rails.
13. If necessary, repeat steps 11 and 12 until the module does not bind against the slides.
14. If the rails on your rack are not threaded, install a clip nut on each front rail at the height of the captive screws on the front panel of the Base Module. If the rails on your rack are threaded, skip this step.
15. Slide the Base Module into the rack, and tighten the captive screws.
16. Once you have securely installed the MiniLibrary into the standard rack, proceed to **Section B.2 - Interfaces and Cabling**.

B.1.2 Rackmounting in a StorageWorks Metric Cabinet

These procedures assume that you have already separated the slide racks and have attached the mounting brackets to the slides as described in the beginning of this chapter.

If you have done so, you are now ready to install the metric conversion brackets supplied with the base module. These adapter brackets are designed to mount 4U high (IU=1.75") RETMA modules into a metric rack which enables the pass-through system to work properly.

Figure B-3 Parts List for StorageWorks Metric Rackmounting

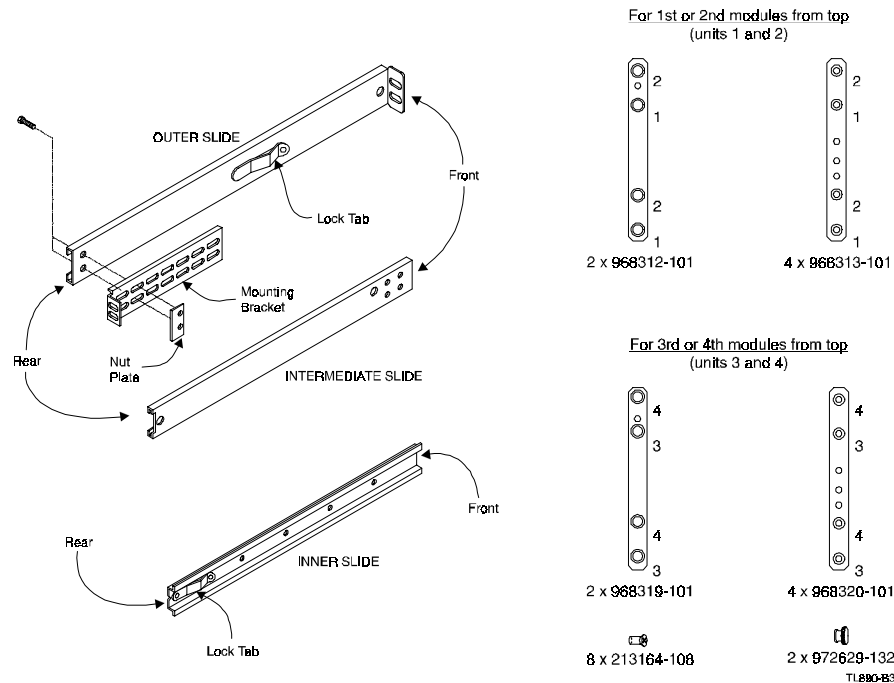

CAUTION!

The cooling fan at the rear of the drive must not be obstructed when the drive is installed in the rack. It is advisable to allow two inches of clearance behind the rear panel of the module.

Make certain that when the Module is fully extended that a force of 20% of the rack weight, but not more than 57 lb. applied in any direction but upwards does not cause the rack to overbalance.

Metric Conversion Bracket Description and Identification:

1. Refer to Figure B-3 to identify and take inventory of the metric conversion hardware included in your metric rackmount kit.
2. Determine where the module you are installing is going to be located relative to the top module.
 - b) If the module you are installing is going to be located on the top of the stack or the second from the top (unit 1 or 2), the parts which you will need to install this module are:

2 pieces	968312-101
4 pieces	968313-101
 - b) If the module you are installing is going to be located third or fourth from the top (unit 3 and 4), the parts which you will need to install this module are:

2 pieces	968319-101
4 pieces	968320-101
 - c) Sort out the appropriate adapters for your application. The part number is stamped in the middle of the part for identification.
3. Next to each mounting hole in the bracket, numbers are stamped which correspond to the module number. If you are installing the first module for example, mount the flat head screws (P/N 213164-108) through the holes marked #1.

Metric Rackmount Procedure:

1. *Reference Figure B-4, Metric Rackmount Installation Layout.* Mount the appropriate metric conversion bracket to both ends of the slide using the 10-32 nuts provided in the slide kit. Do this for both the left and right slide assembly. For modules 1 and 2, use P/N 968313-101. For modules 3 and 4, use P/N 968320-101. Make sure that these brackets are oriented so that the numbers are right side up in all corners.
2. Mounting the bracket/slide assembly to the StorageWorks:

I. If installing the first module, select a mounting location.

- a) Mount each slide/bracket assembly to the rack by aligning the two mounting holes marked #1 to holes on the rack. Start by mounting the slide/bracket assembly to the **rear** of the StorageWorks first. Hold the bracket/slide assembly in place with one hand, fasten a mounting screw to the holes marked #1.
- b) To mount the front bracket, place bracket (P/N 968312-101) **in front** of the rack with the holes marked #1 aligned to the holes on the rack.
- c) Extend the slide/bracket assembly forward to mate with the rack. Align the holes marked #1 on the slide/bracket assembly with the hole #1 on the front bracket and fasten two mounting screws through the two #1 holes.
- d) Be careful to mount all four brackets at the same height. You can use a ruler or count holes to achieve this.
- e) Tighten all four corners and the slide extension.

I. Procedure for installing modules 2, 3, or 4:

- b) Each unit is 7 inches high. To locate the mounting location of the next bracket/slide assembly, use a ruler to measure 7 inches vertical distance of the protruding stud from the bracket above to the stud of the bracket which is to be installed. The mounting holes marked for the number of the module being installed should automatically line up with the rack holes.

- b) Using mounting screws (P/N 213164-108), mount the slide bracket assembly using the two mounting holes marked 2, 3, or 4 to mount the second, third or fourth module respectively. Start by mounting the slide/bracket assembly to the rear of the StorageWorks cabinet. Hold the bracket/slide assembly in place with one hand, fasten the mounting screw to the bracket holes marked with a number that corresponds to the module number.
- c) Be careful to mount all four brackets at the same height. You can use a ruler or count the hole numbers to achieve this.
- d) Tighten all four corners and the slide extension.

Figure B-4 Metric Rackmount Installation Layout

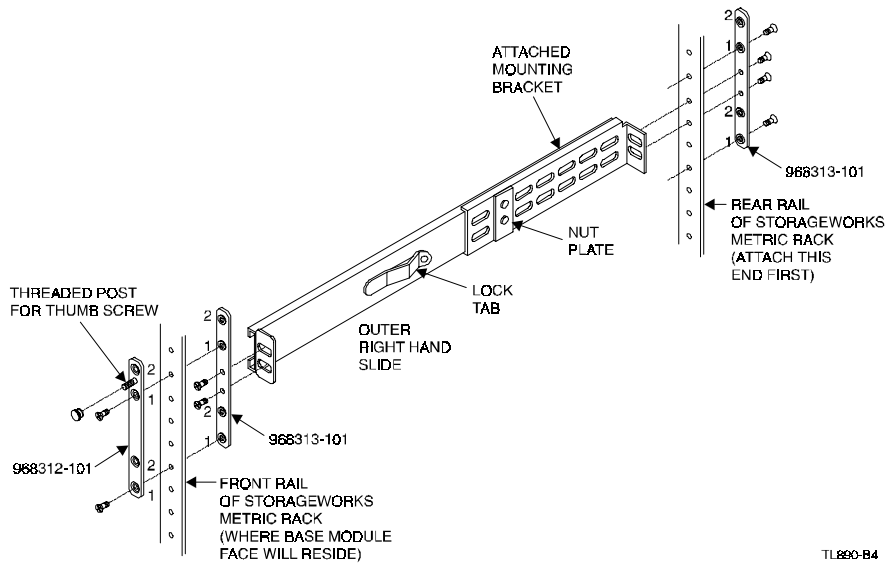

TL890-B4

B.2 Interfaces and Cabling

Cabling consists of connecting the module to the host interface and terminating the busses properly.

Refer to Figure B-5. If the Base Module is to be installed alone, that is, not as part of a multi-module subsystem, the connections required are the SCSI connection or connections to the host, and the AC power connection. The Global Control interface connector is used only when the module is used in combination with other modules as part of a DLT MiniLibrary subsystem.

Figure B-5 Rear Panel Connectors, Terminator and Cables

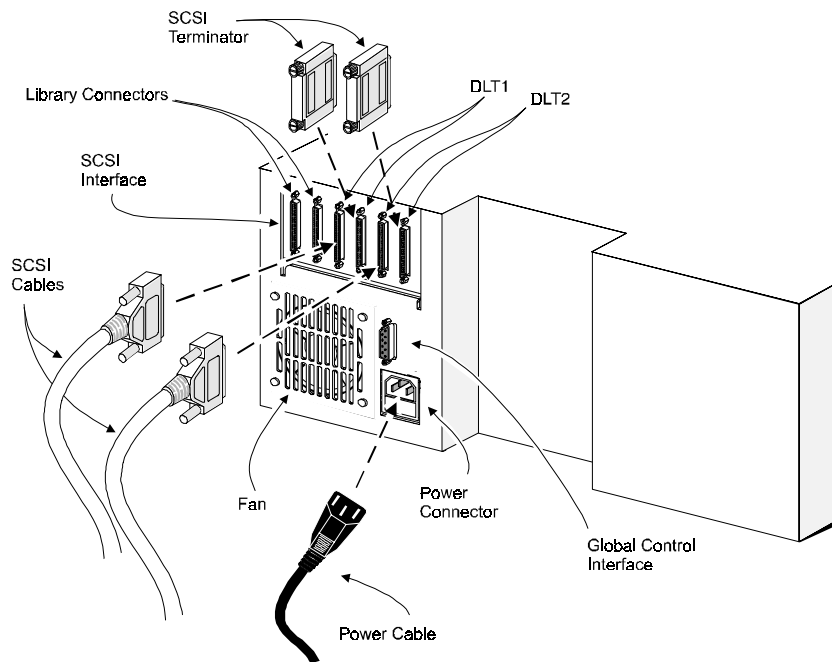

B.2.1 Power Cable

The AC power cable is a standard grounding AC cable which attaches to a connector on the rear panel. Connect the cable to the connector on the module, and connect the other end to a reliably grounded AC outlet or rack power outlet.

B.2.2 Interfaces

The DLT Mini-Library comes with a differential 68-pin HD D-series connector. Each drive has a separate bus, with a pair of SCSI-2 connectors, and the library robotics has a separate bus, with a pair of SCSI-2 connectors. In this configuration there are six SCSI-2 connectors on the rear panel. In the single-drive models, two of the six connectors are inactive (DLT2). There is no requirement that the separate SCSI busses be on the same host.

Both of the drives and the library robotics are separate SCSI devices. Each requires a unique SCSI address on the bus they are connected to. **It is recommended to configure the DLT MiniLibrary Tape Drives for independent SCSI bus interface to achieve maximum transfer performance for each device.** It is acceptable to daisy-chain Library robotics and one DLT Tape Drive without impacting system performance.

A terminator of the proper type (differential) must be installed on each unused connector of each bus, as explained below in the section headed 'Interface Cable and Terminator Installation.' Figure B-5 shows the SCSI cable, connectors and bus terminator used on the module.

In order to connect the module to a host computer system, the host system must have at least one SCSI controller and the appropriate driver software. Your Technical Support representative is available to answer your questions about installation procedures for specific host systems.

Before cabling the system, see the recommended SCSI cable specifications in Section B.3, and *Interface Cable and Terminator Installation* in Section B.3.2.

B.3 Interface Cable Specifications

The detailed requirements for SCSI cables are set forth in ANSI X3.131-1994. It is recommended that all SCSI cables used with the DLT MiniLibrary Base Module meet at least the following requirements:

- Shielded or double-shielded, as required to meet EMI specifications
- Impedance match with cable terminators of 132 ohms, ideally
- Characteristic impedance between 90 and 132 ohms, required
- 50-conductor flat cable or 25-pair twisted-pair should be used
- The maximum cable length for a single-ended SCSI bus is 19.68 feet (6 m)*
- The maximum cable length for the entire differential SCSI bus is 82 ft. (20 m)*
- Cables of different impedances should not be used together

* When calculating the overall length of the bus, be sure to include the internal cabling of the module, which is 75 inches (190 cm) in the daisy-chained option. In the independent-bus version, the lengths are 19 inches (48 cm) for drive 1, 25 inches (64 cm) for drive 2, and 33 inches (84 cm) for the robotics in the separately-wired option. The total internal wiring length of the separately-wired version is 77 inches (195 cm).

Additional specifications to assure the highest SCSI performance can be found in ANSI X3.131-1994 or later.

NOTE

This equipment has been tested for electromagnetic emissions and immunity using good quality shielded cables. The use of unshielded cables, poor quality cables or other variances from good practice may result in non-compliance with national and international rules.

B.3.1 Terminators

A terminator must be installed on the drive if the drive is to be used at either end of a SCSI bus, such as the first or last device along a daisy-chain, or as a single SCSI peripheral. The appropriate type and quantity of terminator is shipped with your module. It is packaged in the accessory bag that arrives with the module.

NOTE

It is important to use only differential terminators on a differential SCSI bus.

B.3.2 Interface Cable and Terminator Installation

To properly cable the drive:

1. Make sure that your host system has an appropriate SCSI interface card and software drivers installed.
2. Inspect the terminator and make sure it is a differential type, to match your system. SCSI terminators should be clearly marked “differential”.
3. Determine whether the module is to be connected in daisy-chain fashion with other devices, or a single bus for each device.
4. If configuring each device for a single device per bus, the host connection should be connected to the first connector for each device and the terminator installed in the adjacent connector (refer to figure B-5).
5. If configuring as a daisy-chain, the host cable connects to the first Library connector, the second Library connector is then connected to the DLT1 connector, and the terminator is connected to the adjacent DLT1 connector. If configuring a second DLT drive remove the SCSI terminator from the DLT1 connector and install supplied 1-foot SCSI cable between DLT1 connector and the first DLT2 connector. Install the SCSI terminator into the adjacent DLT2 connector. This configuration is not recommended for the two tape drive DLT MiniLibrary.
6. Make sure that the cable you use meets the specifications listed earlier in this appendix.
7. Measure the cable length to connect the module to the computer system.
8. Be sure that the length of the entire bus falls below the maximum permissible length given in the section on SCSI cable specifications



Accessories

This appendix lists the supplies available for the TL891 DLT MiniLibrary.

C.1 Data and Cleaning Cartridge Ordering Information

You can order additional CompacTape Data or Cleaning Cartridges for the TL891 by contacting your authorized Digital reseller or by calling Digital's DECdirect ordering service at 1-800-DIGITAL. Table C-1 lists cartridge ordering part numbers.

Table C-1 Data and Cleaning Cartridge Part Numbers

P/N	Description
TK85K-01	CompacTape III Data Cartridge (quantity, 1)
TK87X-01	CompacTape IIIXT Data Cartridge (quantity, 1)
TK88K-01	CompacTape IV Data Cartridge (quantity, 1)
TK85-HC	Cleaning Tape Cartridge (quantity, 1)

C.2 Bar Code Label and Magazine Ordering Information

Additional Bar Code Labels or Magazines can be ordered by calling Overland Data at **1-800-729-8725** Monday through Friday; 7:00 a.m. to 5:00 p.m. (PT) and asking for *Spares Sales*. Part numbers are provided in the following table.

Table C-2 Bar Code Label and Magazine Part Numbers

P/N	Description
106045-001	Bar Code Labels (quantity, 100)
106035-001	Magazine (quantity, 1)

Order Lead-Time: Next day if product is in stock; 10-20 working days if not stocked.

General Terms of Sale: P.O. or written order faxed to: (617) 571-3664 prior to shipping an order. Methods of Payment include COD, Credit Card, Net/30 OAC.



Regulatory Information

This appendix provides regulatory information applicable to the TL891 DLT MiniLibrary.

The following FCC and VCCI notices apply to the table top or embedded version of the TL891 drive. Other models, and expanded versions, will be covered in similar notices in documentation for the system, or storage enclosure in which the drive(s) reside.

D.1 User Manual Statement for Equipment Meeting FCC Class A Requirements

This equipment has been tested and found to comply with the limits for a Class A digital device, pursuant to Part 15 of the FCC rules. Operation is subject to the following two conditions: (1) This device may not cause harmful interference and (2) This device must accept any interference that may cause undesirable operation.

This equipment generates, uses, and can radiate radio frequency energy and, if not installed and used in accordance with the instructions, may cause harmful interference to radio communications. However, there is no guarantee that interference will not occur in a particular installation. If this equipment does cause harmful interference to radio or television reception, which can be determined by turning the equipment off and on, the user is encouraged to try to correct the interference by one or more of the following measures:

- Reorient or relocate the receiving antenna.
- Increase the separation between the equipment and receiver.
- Connect the equipment into an outlet on a circuit different from that to which the receiver is connected.
- Consult the dealer or an experienced radio/TV technician for help.

D.2 User Manual Instructions for Equipment Meeting VDE Class B Requirements (VFG 1046/84 and VFG 243/91 for Germany)

Für Bundesrepublik Deutschland
For Federal Republic of Germany
Pour la République fédéral d'Allemagne

Bescheinigung des Herstellers/Importeurs

Dieses Gerät ist Übereinstimmung mit den Bestimmungen der BMPT Vfg. 243/1991 und Vfg. 46/1992 in Verbindung mit EN55022:1987 (DIN VDE 0878-3:11.89) oder Vfg. 1046/1984 mit Vfg. 483/1986, funkentstört. Es trägt als Nachweis der EMV-Konformität entweder eine Konformitätskennzeichnung oder das freiwillige VDE-Funkschutzzeichen.

Der vorschriftsmäßige Betrieb mancher Geräte (z.B. Meßsender) kann allerdings gewissen Einschränkungen unterliegen. Beachten Sie deshalb die unten aufgeführten Hinweise.

Für Geräte die nicht mit dem VDE-Funkschutzzeichen versehen sind wurde dem Bundesamt für Zulassungen in der Telekommunikation (BZT) des Inverkehrbringen dieses Gerätes angezeigt und die Berechtigung Zur Überprüfung der Serie auf Einhaltung der Bestimmungen eingeräumt.

Betreiberhinweis

Wir sind verpflichtet, Sie auf folgende Fakten hinzuweisen (BMPT-Amtsblattverfügung 243/91 bzw. 1046/84 §2, Abschnitt 5):

Dieses Gerät wurde funktechnisch sorgfältig entstört und geprüft. Wird dieses Gerät innerhalb einer Anlage zusammen mit anderen Geräten betrieben, muß bei Inanspruchnahme der "Allgemeinen Betriebsgenehmigung" nach BMPT-AmtsblVfg. 243/91 bzw. 1046/84 die gesamte Anlage den unter §2, Abschnitt 1, genannten Voraussetzungen entsprechen.

Externe Datenkabel:

Sollte ein Austausch der von Digital spezifizierten Datenkabel nötig werden, muß der Betreiber für eine einwandfreie Funkentstörung sicherstellen, daß Austausch kabel im Aufbau und Abschirmqualität dem Digital Originalkabel entsprechen.

D.3 VCCI Notice for Japan Class I Equipment

この装置は、第一種情報処理装置（商工業地域において使用されるべき情報処理装置）で商工業地域での電波障害防止を目的とした情報処理装置等電波障害自主規制協議会（VCCI）基準に適合しております。
従って、住宅地域またはその隣接した地域で使用すると、ラジオ、テレビジョン受信機等に受信障害を与えることがあります。
取扱説明書に従って正しい取り扱いをして下さい。

Translation: This equipment is in the 1st Class category (information equipment to be used in commercial and/or industrial areas) and conforms to the standards set by the Voluntary Control Council for Interference by Information Technology Equipment aimed at preventing radio interference in commercial and/or industrial areas.

Consequently, when used in a residential area or in an area adjacent thereto, radio interference may be caused to radios and TV receivers, etc. Read the instructions for correct handling.



Product Notes for Sun

This appendix describes the installation and configuration procedures involved in enabling the TL891 DLT MiniLibrary to communicate within a Sun SPARC system (running Solaris 2.4 and 2.5.x) environment.

E.1 General Information

- Densities can only be changed at the beginning of the tape.
- To load a tape into the TL891 refer to *Section 2, Operation*.
- Compression can be enabled or disabled at any time, with the change taking effect immediately when writing TZ89 density.
- Density Codes for Solaris are listed in Table E-1.

E.2 Modifications Required for Solaris 2.4 and 2.5.x

E.2.1 Installation Procedure

In order to support the addition of this device, drive information must be supplied in the `/kernel/drv/st.conf` file as global properties that apply to each of the targets, or as properties that are applicable to one target only. The "st driver" looks for the property called "tape-config-list". For additional information, read the man page "st". We recommend the use of the *global properties* approach.

NOTE:

Internal to the TL891 MiniLibrary is the TZ89 DLT Cartridge Tape.

E.2.1.1 System Modification

Perform the following steps to modify the system to communicate with the tape drive:

1. From the command line, type:

```
cd /kernel/drv
```

2. Edit the “**st.conf**” file by adding the following before the first occurrence of “name=”:

```
# entry for TZ89 tape drive
tape-config-list = "DEC      TZ89",
"DEC 70GB Cart. DLT Streaming /w Compression", "TZ89-
data";
TZ89-data = 1,0x36,0,0x1639,4,0x82,0x83,0x84,0x85,3;
```

Where:

In the “**tape-config-list**” parameter:

- The first parameter (DEC TZ89) is the parameter returned by the TZ89 DLT Cartridge Tape Drive on a SCSI inquiry command. (There should be five spaces between “DEC” and “TZ89” elements.)
- The second parameter (DEC 70GB Cart. DLT Streaming /w compression) is a *nickname* for the drive.
- The third parameter is defined as follows:

In the “TZ89-data” string:

- The first parameter (1) is the revision level of the software and is set to 1.
- The second parameter (0x36) is the **tape type**, specifying “other” tape drive. (This is defined in /usr/include/sys/mtio.h.)
- The third parameter (0) is the block size in bytes. Zero “0” means variable block size.
- The fourth parameter (0x1639) defines the options selected. The 0x1639 value represents the following options:

ST_VARIABLE = 0x0001
ST_BSF = 0x0008
ST_BSR = 0x0010
ST_LONG_ERASE = 0x0020
ST_KNOWS_EOD = 0x0200
ST_UNLOADABLE = 0x0400
ST_LONG TIMEOUTS = 0x1000

- The fifth parameter (4) defines the number of densities. The maximum definable number of densities is 4, which is a Sun Operating System limitation.

NOTE

In our example entry we choose to use TZ88 native and compressed modes for the two lower densities and TZ89 native and compressed modes for the two higher density drivers. Because your situation may demand something other than these settings, we have included Table E-1 which lists all other valid density values. Refer to Table E-1 for other density settings.

- The sixth parameter (0x82) is the vendor-unique density code for the CT-IV, 20 GB.
- The seventh parameter (0x83) is the vendor-unique density code for CT-IV, 40 GB *compressed* mode.
- The eighth parameter (0x84) is the vendor-unique density code for the CT-IV, 35 GB.
- The ninth parameter (0x85) is the vendor-unique density code for the CT-IV, 70 GB *compressed* mode.
- The last parameter in the **TZ89-data** parameter is the default density 3, CT-IV in the 70 GB *compressed* mode.

Where:

CT-IV = CompacTape IV Data Cartridge

E.2.1.2 System Shutdown

After you have edited the “**st.conf**” file, shut down the system as follows:

```
sync
cd /
shutdown -i0 -g0 -y
```

E.2.1.3 Installation of the Tape Drive

Install the tape drive into the storage subsystem and power on the workstation. We recommend that the TZ89 DLT Cartridge Tape Drive SCSI device address be set to ID 4 or 5.

NOTE

If your SCSI host adapter is supported by the “probe-scsi-all” command, then you can use this command at the boot prompt to verify that the connected device is correctly attached to the system.

E.2.1.4 Rebooting of System

Reboot the system using the following command at the boot prompt:

```
OK>boot -rv
```

Note that the switch “**r**” forces the kernel to be re-configured, and switch “**v**” enables a display of the system configuration at boot time.

The system compiles the kernel and creates special files in **/dev** so that it can communicate with the TL891 MiniLibrary. Since you booted the system using the verbose switch, the system displays all of its SCSI targets. Verify that “DEC 70GB Cart. DLT Streaming /w Compression” is displayed as a target when the system is booting. At this time, the tape drive is configured in the **/dev** directory in two ways: **rmt** format, and **rst** format.

“rmt” format

In this format, the drive is configured with various options. For further explanations, see the man pages on “st” (the modes are *x*, *xl*, *xm*, *xh*, *xc*, and *xu*, where *x* is the **rmt** number).

- Options *x*, *xu*, and *xc*, correspond to the 0x85 (CT-IV, *compressed*) density mode.
- Option *xl*, corresponds to the 0x82 (CT-IV) density mode.
- Option *xm* corresponds to 0x83 (CT-IV) density mode.
- Option *xh* corresponds to 0x84 (CT-IV, *native*) density mode.
- Option *b* associates with the BSD behavior and is for backward compatibility on all of the above options. For further information, refer to the man pages of “mtio”.
- The *n* option provides access to the device with **no rewind**, similar to *nrst* (below), and is also applicable to all of the above options.

Where:

CT-IV = CompacTape IV Data Cartridge

“rst” format

Special files “**rst**” (rewind on close) and “**nrst**” (no rewind on close) are also built and reside in the **/dev** directory. For example, if the SCSI target ID for the drive is 4 and the drive is connected to the native SCSI bus, then “**rst**” will be “*rst4, rst12, rst20, and rst28*” and *nrst* will be “*nrst4, nrst12, nrst20, and nrst28*”.

- *rst4* and *nrst4* correspond to the 0x82 density mode (CT-IV, *native* format)
- *rst12* and *nrst12* correspond to the 0x83 density mode (CT-IV, *compressed* format)
- *rst20* and *nrst20* correspond to the 0x84 density mode (CT-IV, *native* format)
- *rst28* and *nrst28* correspond to the 0x85 density mode (CT-IV, *compressed* format)

Where:

CT-IV = CompactTape IV Data Cartridge

E.2.1.5 Test

NOTE:

Verify that a cartridge is loaded into the tape drive before running test.

To test the TL891 MiniLibrary, back up the “**passwd**” file to tape using the “**tar**” command, as follows:

```
tar cvf /dev/rst4 /etc/passwd
```

The system responds with:

```
a /etc/passwd 1 blocks
```

Note that, depending on the size of the file, a different number of blocks may be reported.

E.2.1.6 Verification of Password and Connectivity

Verify that the “**passwd**” file was saved to tape using the following command:

```
tar tvf /dev/rst4
```

The system responds with

```
/etc/passwd
```

The installation and verification procedure is now complete.

Verify the connectivity of the TL891 MiniLibrary device by typing the following:

```
OK>probe-scsi-all
```

If the TL891 MiniLibrary is correctly installed, the console will display a listing which will include the following:

```
< varied text >
```

```
Target 0
```

```
Unit 0 Removable Device Type 8 DEC TL800 (c) DEC031427-Jun-97
```

```
Target 4
```

```
Unit 0 Removable Tape DEC TZ89 (c) DEC183797A002
```

```
<varied text>
```

NOTE:

The actual target-id displayed may differ depending on the SCSI-id setting on the device.

C.2.2 Dump Parameters for the Tape Drive

The parameters that should be used when running the **ufsdump** utility with the tape drive are as follows:

density (d) = 85937 (BPI)

blocking factor = 126

Example,

The following parameter is an example of how to back up the entire disk partition (/dev/rdisk/c0t3d0s6) onto the tape drive:

```
ufsdump 0dbf 85937 126
/dev/rst4/dev/rdisk/c0t3d0s6
```

Table E-1 Density Codes for Solaris

Density Code	Meaning
00h	Use default density
17h	CT-III – 42500 bpi FMF serial cartridge tape X3B5/91-1174, 2.6 GB
18h	CT-III – TZ86 – Same as TK85 except with 56 track pairs versus 24, 6 GB
19h	CT-III – 62500 bpi, 64 track pairs, serial cartridge tape, 10 GB
1Ah	CT-III – 81633 bpi, 64 track pairs, serial cartridge tape, 20 GB (without compression)
7Fh	No change from previous density (Mode Select)
80h	CT-IV – 62500 bpi, 64 track pairs, serial cartridge tape, 10 GB (without compression)
81h	CT-IV – 62500 bpi, 64 track pairs, serial cartridge tape, 20 GB (with compression)
82h	CT-IV – 81633 bpi, 64 track pairs, serial cartridge tape, 20 GB (without compression)
83h	CT-IV – 81633 bpi, 64 track pairs, serial cartridge tape, 40 GB (with compression)
84h	CT-IV – 85937 bpi, 52 quad tracks, serial cartridge tape, 35 GB (without compression)
85h	CT-IV – 85937 bpi, 52 quad tracks, serial cartridge tape, 70 GB (with compression)

Where:

CT-III = CompacTape III Data Cartridge

CT-IV = CompacTape IV Data Cartridge

Reader's Comments

Manual Order Number:
EK-TL891-UG. A01

Digital is committed to providing the best products and services. Since our manuals are important components of our products, we value your comments, corrections, and suggestions for improvements. Please take a few minutes to fill out and return this form. Attach additional sheets, if necessary. Thank you.

Manual Rating	Excellent	Good	Fair	Poor
Accuracy (correct presentation of facts)	[]	[]	[]	[]
Completeness (adequate information)	[]	[]	[]	[]
Clarity (easy to understand)	[]	[]	[]	[]
Organization (logical sequence of information)	[]	[]	[]	[]
Layout (easy to follow subject matter)	[]	[]	[]	[]
Indexing (easy to locate desired information)	[]	[]	[]	[]

Errors Noted (include page, paragraph, table or figure number) _____

Most-Liked Features: _____

Least-Liked Feature _____

Suggestions for Improvement _____

<p>Return Address: Digital Equipment Corporation Customer Research Response Center 334 South Street, SHR3-2/W3 Shrewsbury, MA 01545</p>	Name Phone
	Title
	Company
	Street Address
	Mail Stop
	City State ZIP
	Country (if other than USA)

