

This document describes the SW82x Series Cabinet Storage Sets. It shows the location of the controller shelf, SBB shelves, and SCSI cable routing of each storage set. See the appropriate user's guide for detailed information about the cabinet, the shelves, or the I/O modules.

## Description

The three SW82x series configurations are:

- SW820** Five split bus configuration storage sets. Each storage set consists of one controller shelf, three SBB shelves, with an 8-bit I/O module in each SBB shelf. All shelves have a redundant power supply.
- SW821** Seven split bus configuration storage sets. Each storage set consists of one controller shelf, two SBB shelves, with an 8-bit I/O module in each SBB shelf. All shelves have a redundant power supply.
- SW822** Three single bus configuration storage sets. Each storage set consists of one controller shelf, six SBB shelves, with an 8-bit I/O module in each SBB shelf. All shelves have a redundant power supply.

The locations of the 8-bit I/O modules and power supplies are always as shown in Figure 1 and Figure 2.

Figure 1 Typical SBB Shelf with 8-Bit I/O Module

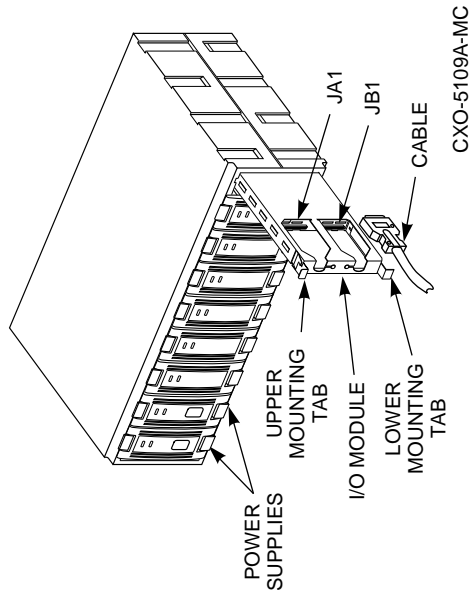
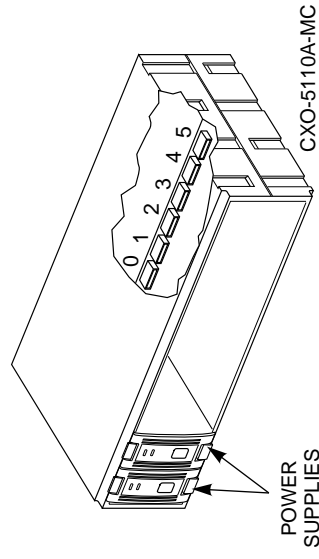

Figure 2 Typical Controller Shelf



# SW820 Storage Cabinet

The five SW820 storage sets cable connections are shown in Figure 3 through Figure 7.

**Figure 3 SW820 Storage Set 1**

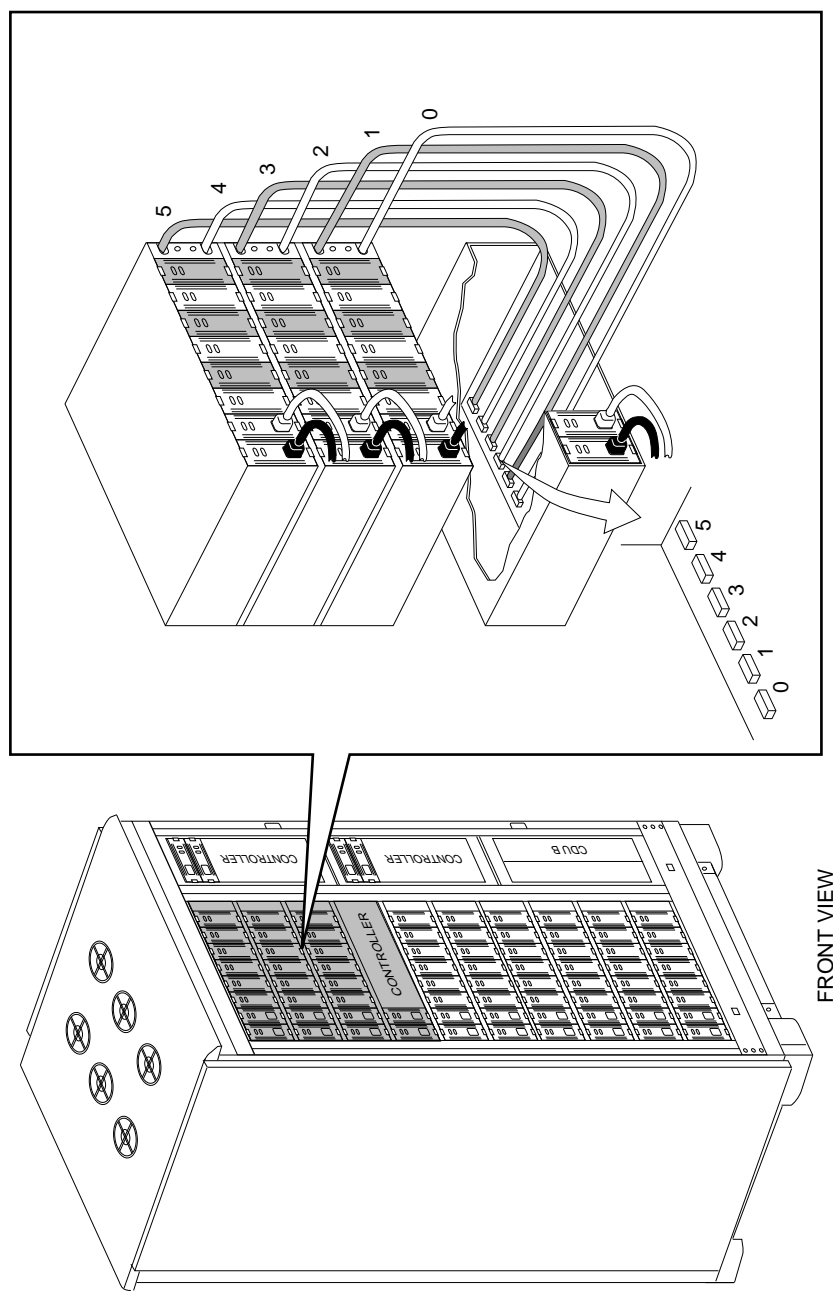

FRONT VIEW

CXO-5094A-MC

Figure 4 SW820 Storage Set 2

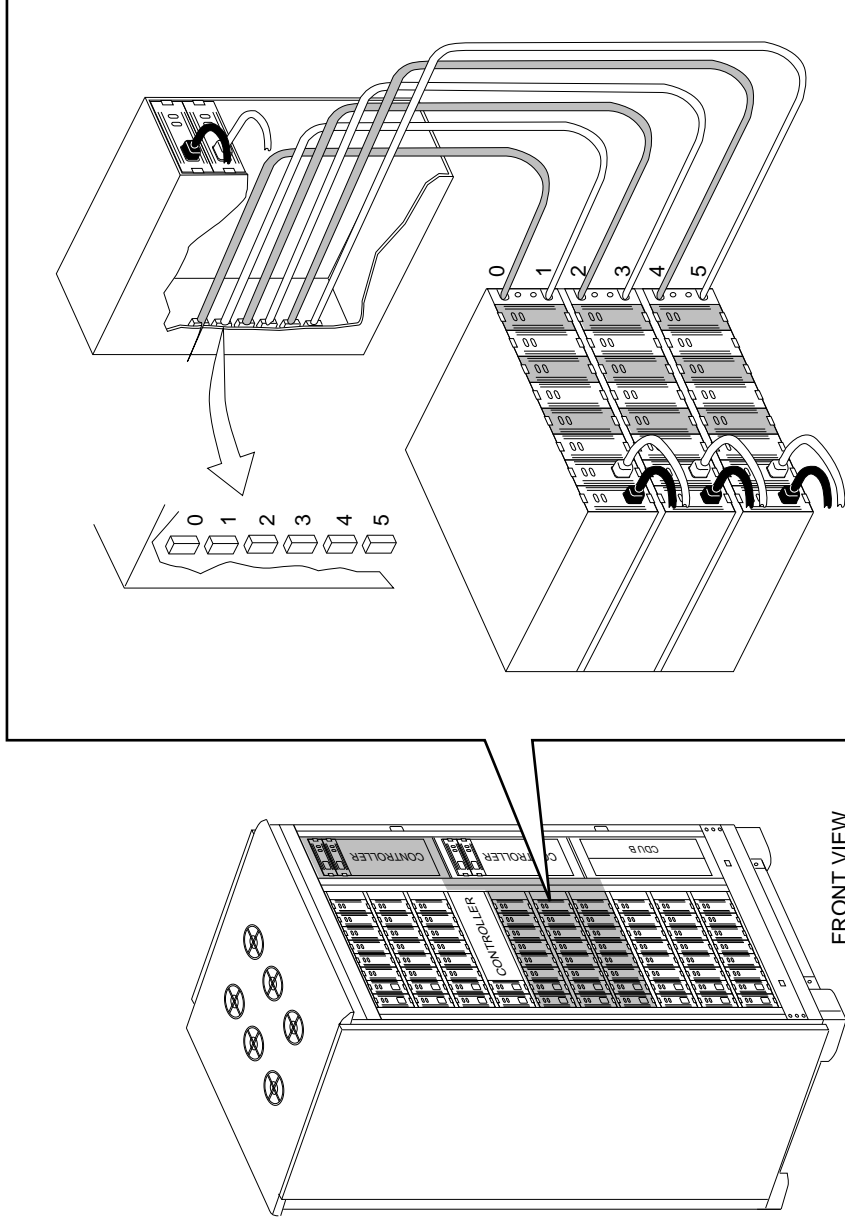

FRONT VIEW

CXO-5095A-MC

Figure 5 SW820 Storage Set 3

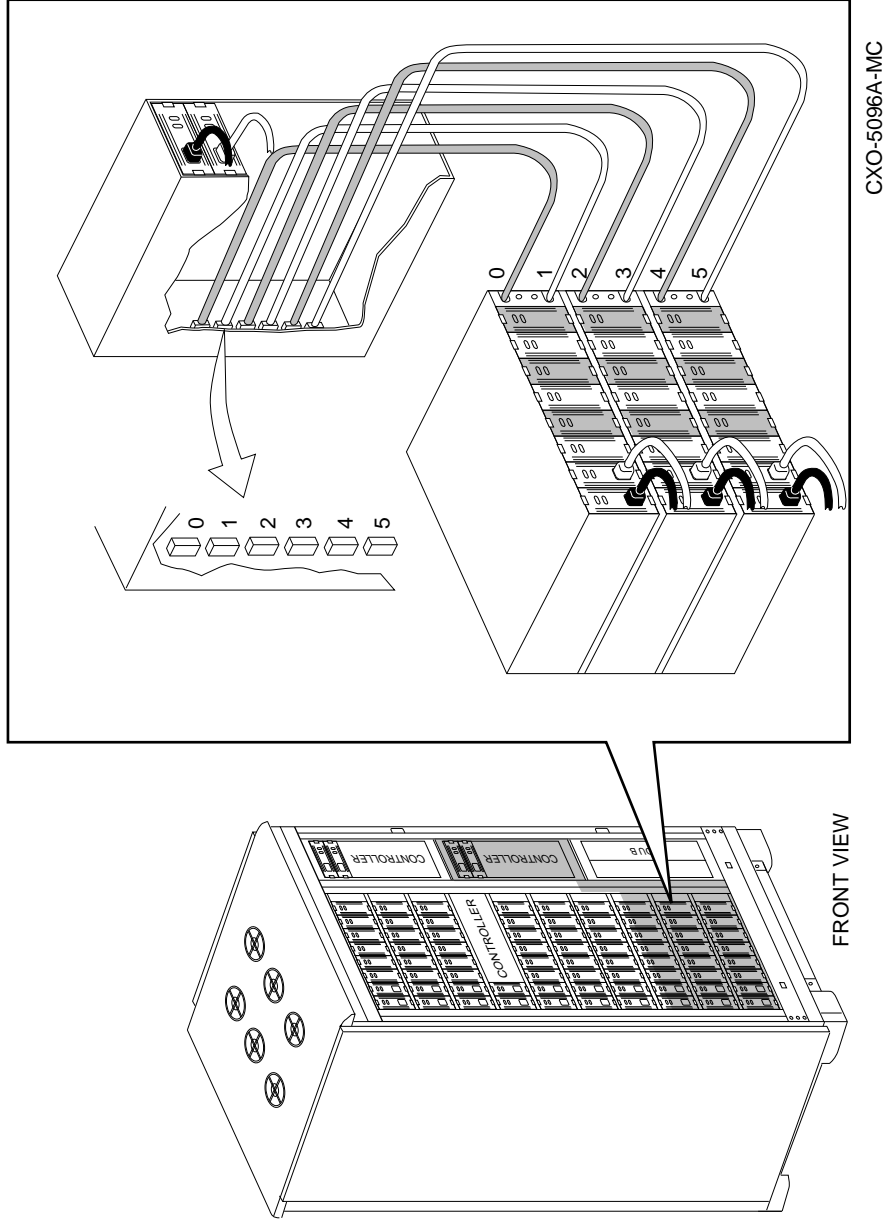
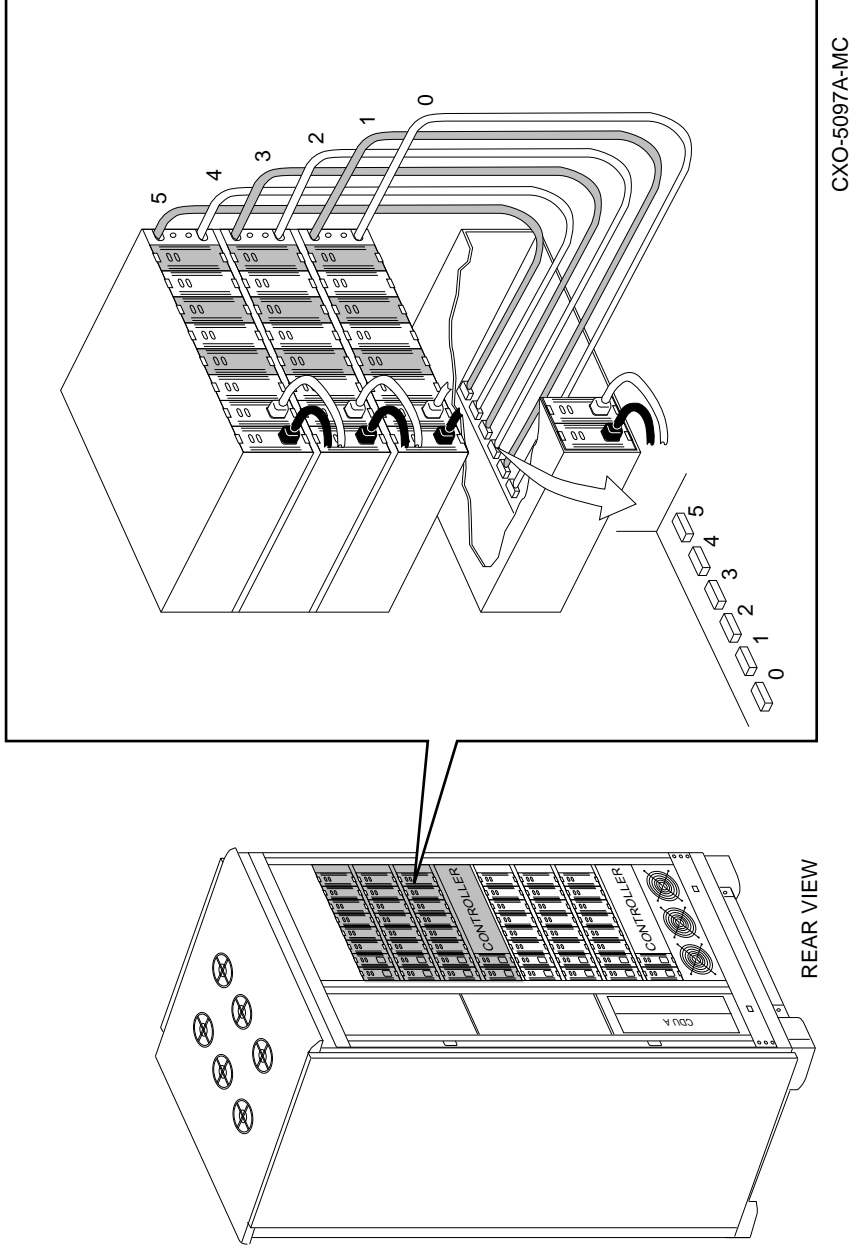
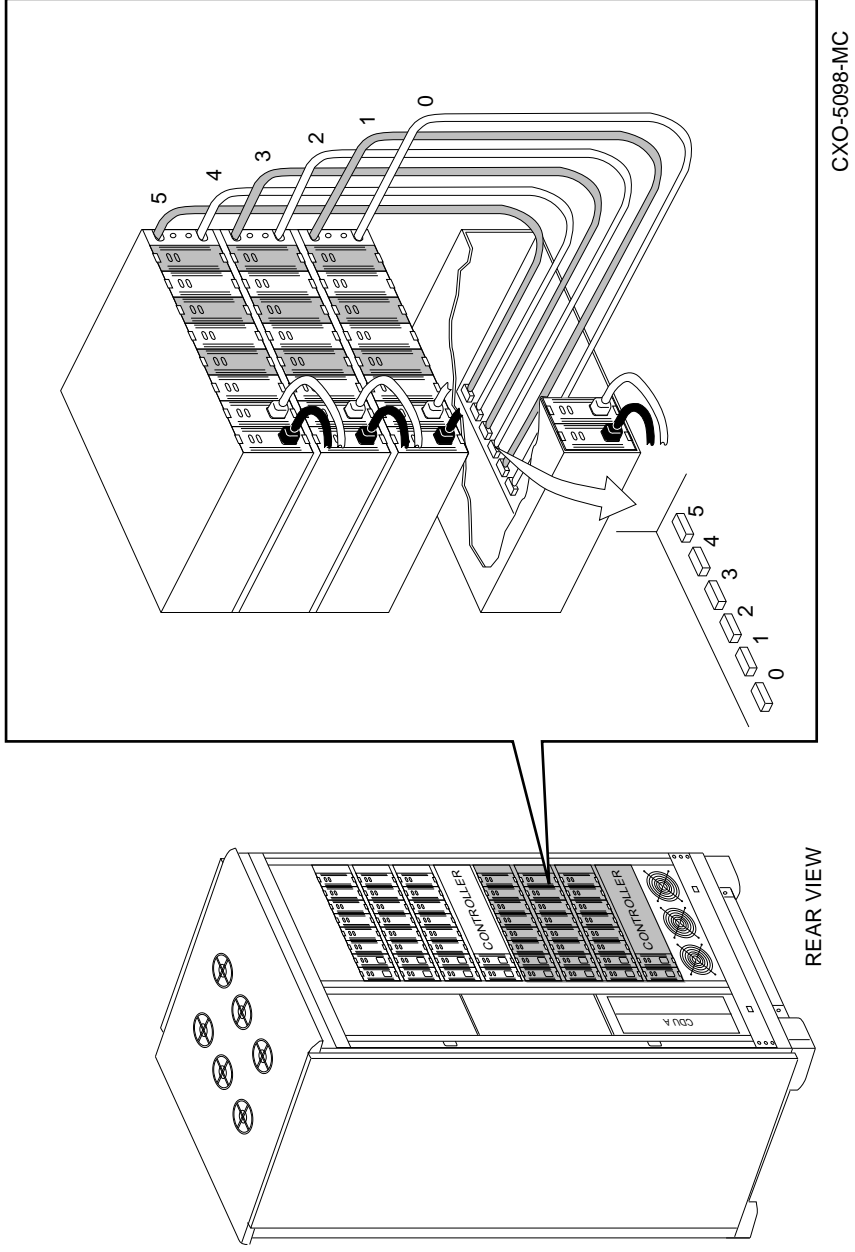

Figure 6 SW820 Storage Set 4



REAR VIEW

Figure 7 SW820 Storage Set 5



## SW821 Storage Cabinet

The seven SW821 storage sets cable connections are shown in Figure 8 through Figure 14.

**Figure 8 SW821 Storage Set 1**

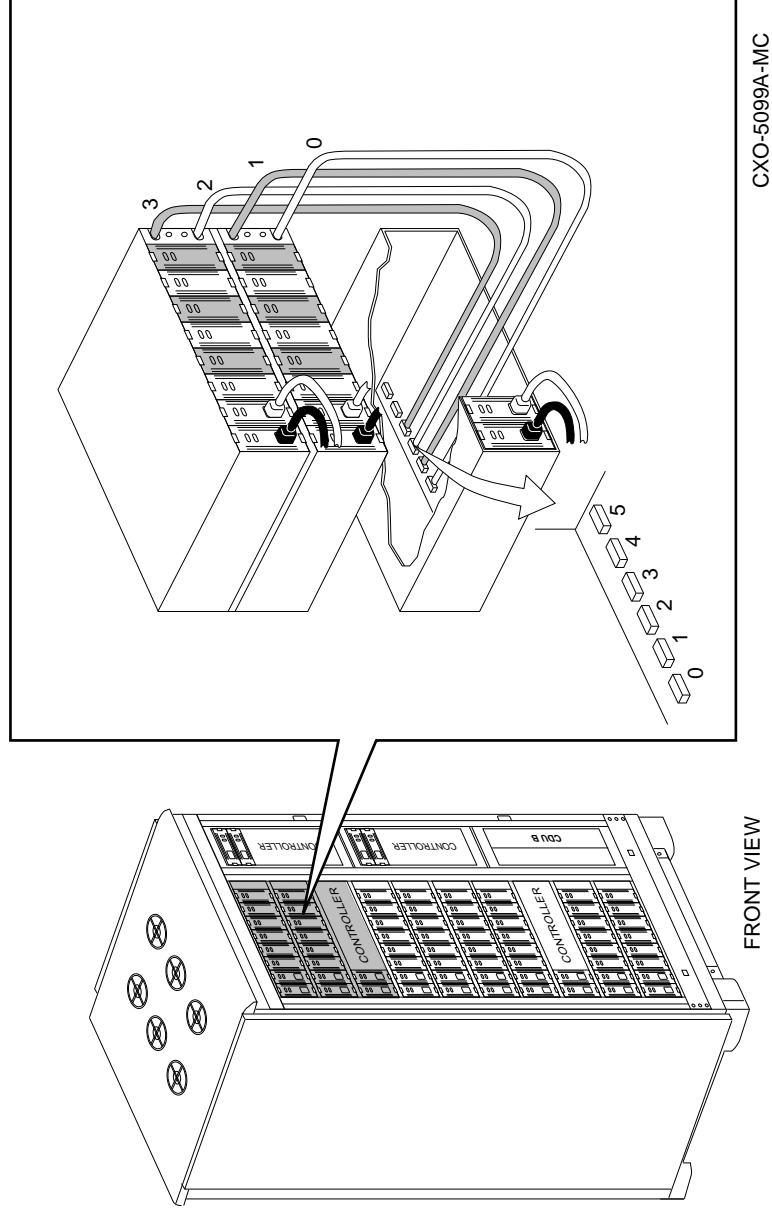
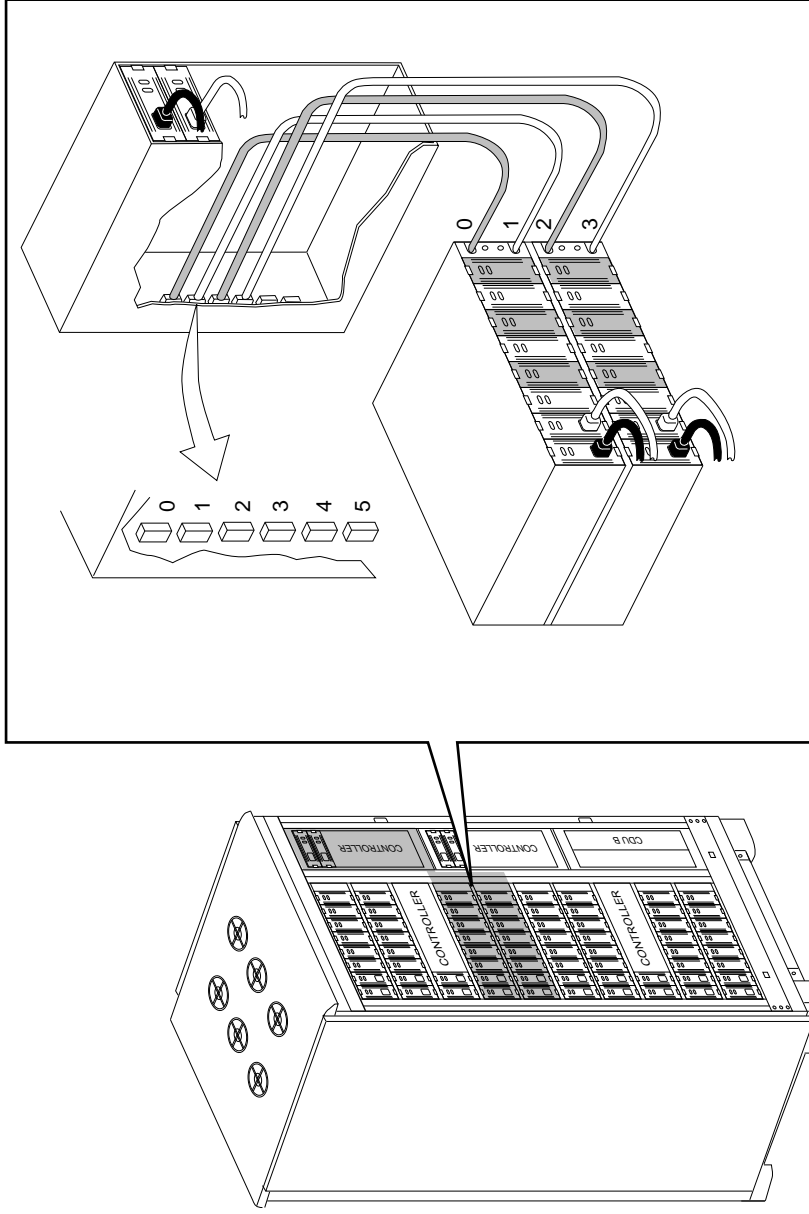

Figure 9 SW821 Storage Set 2



FRONT VIEW

CXO-5100A-MC



Figure 10 SW821 Storage Set 3

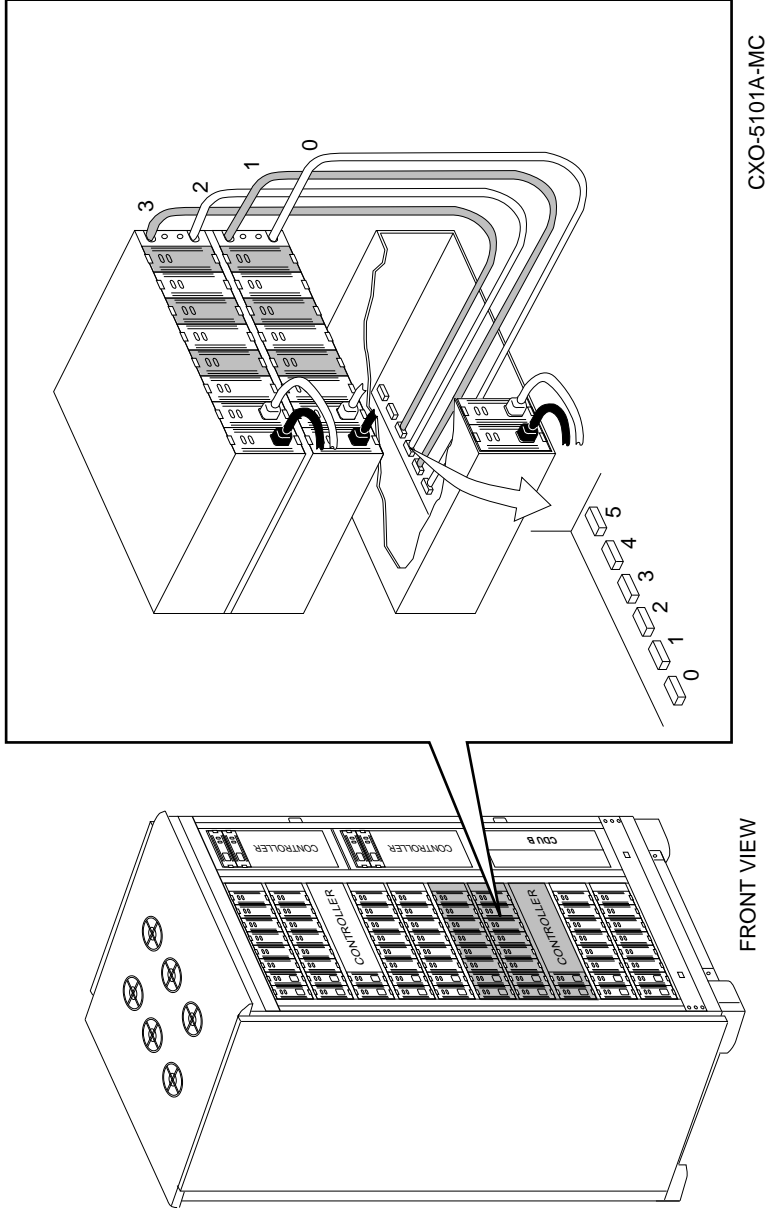

Figure 11 SW821 Storage Set 4

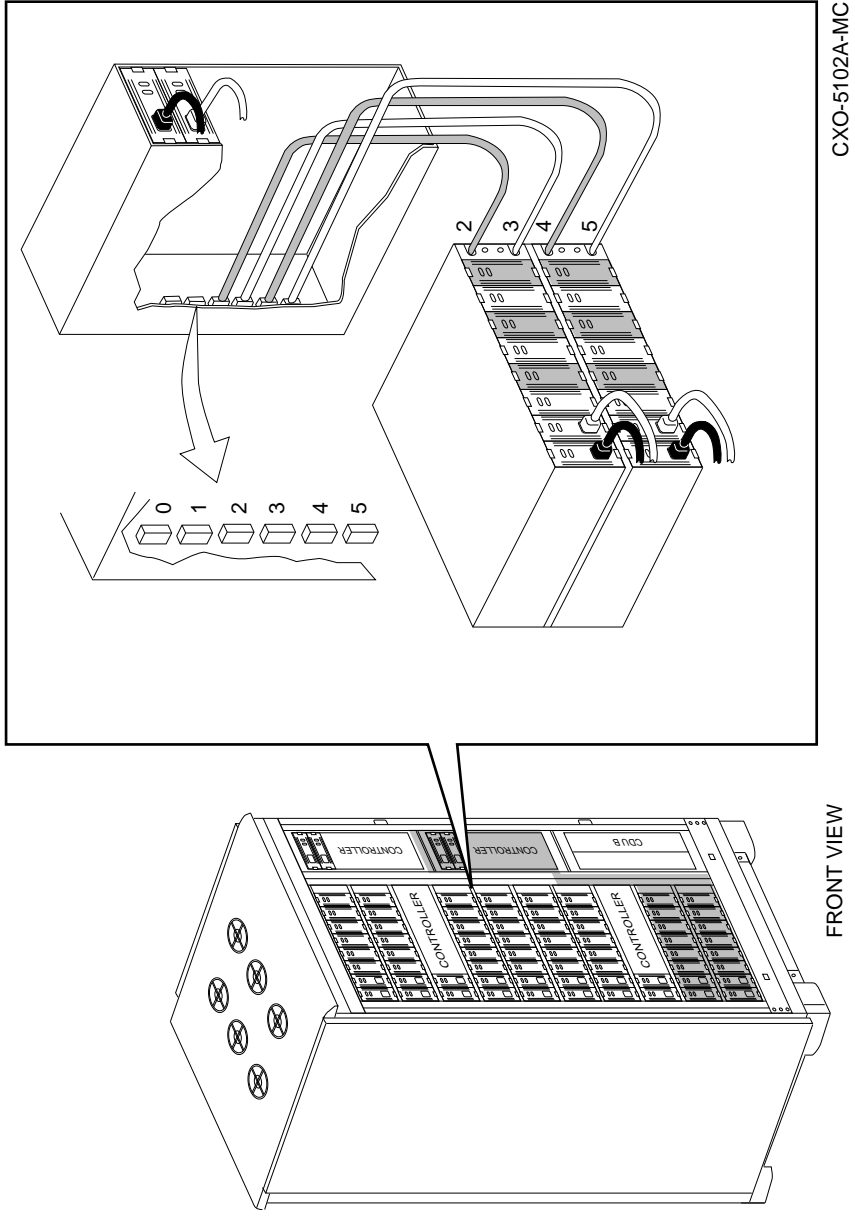

Figure 12 SW821 Storage Set 5

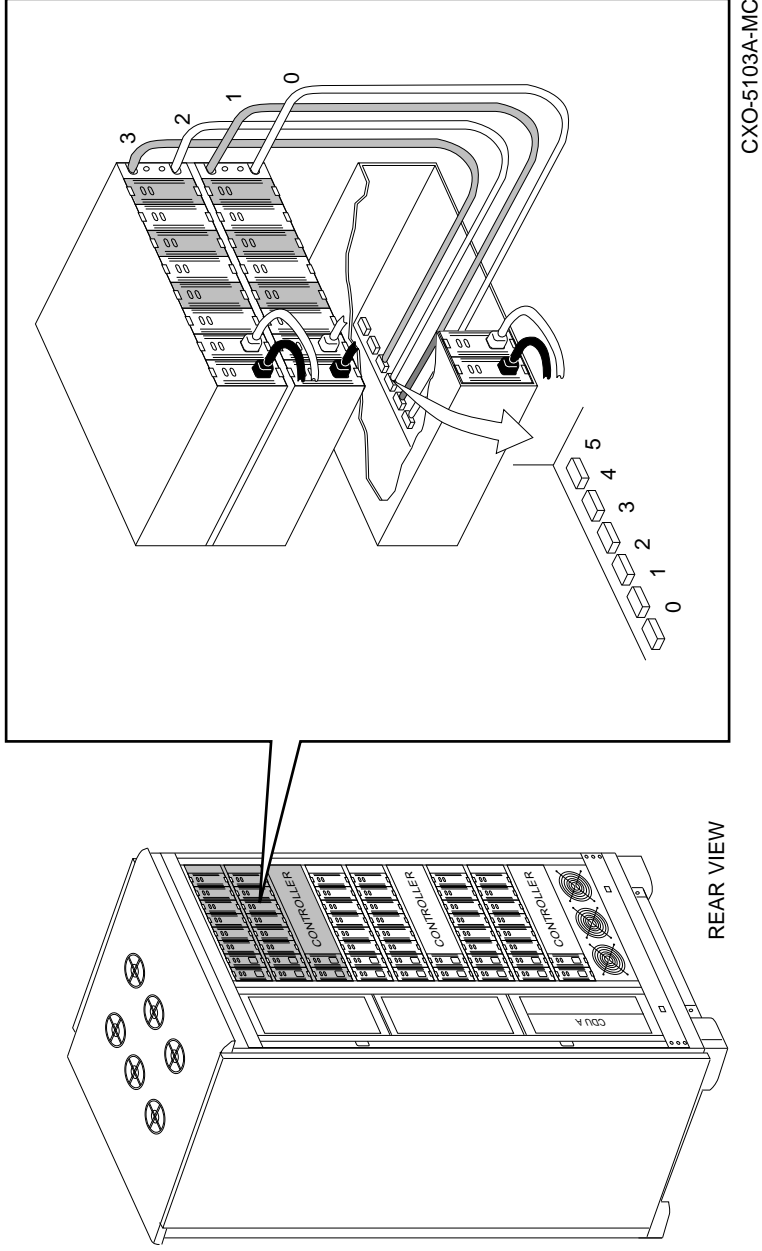

Figure 13 SW821 Storage Set 6

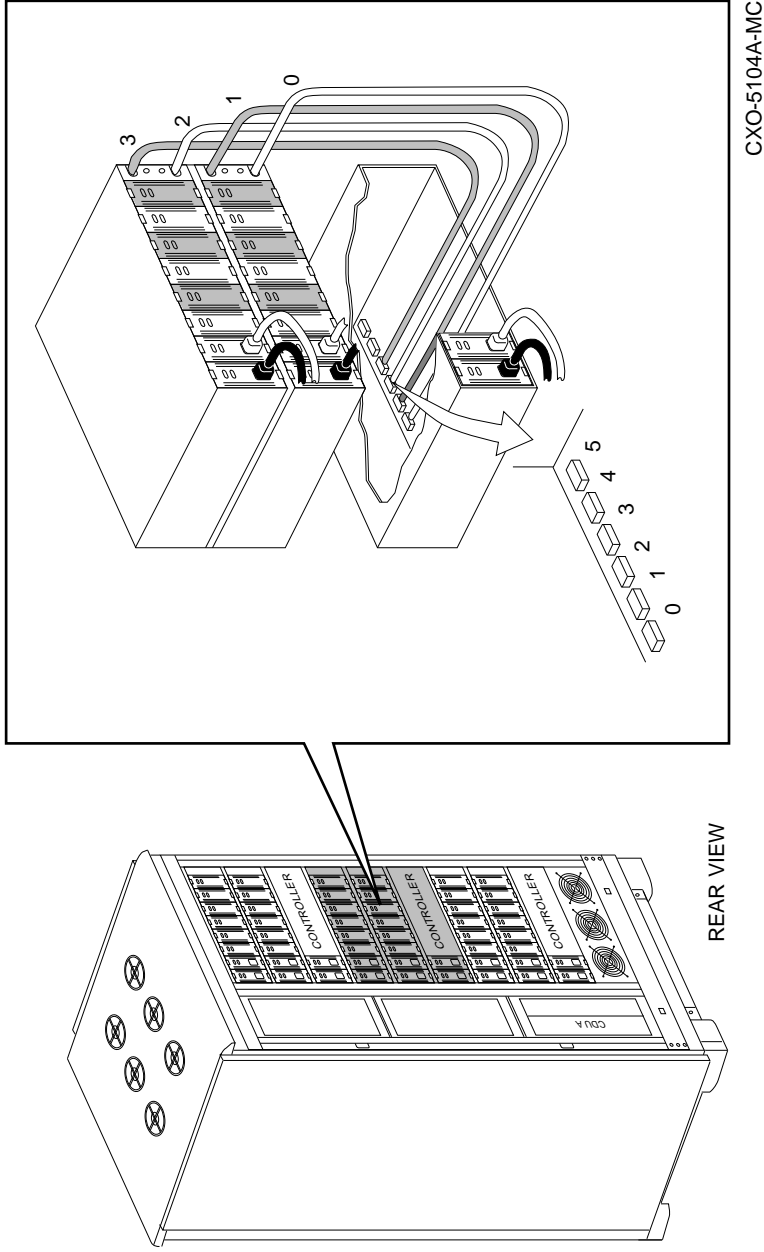
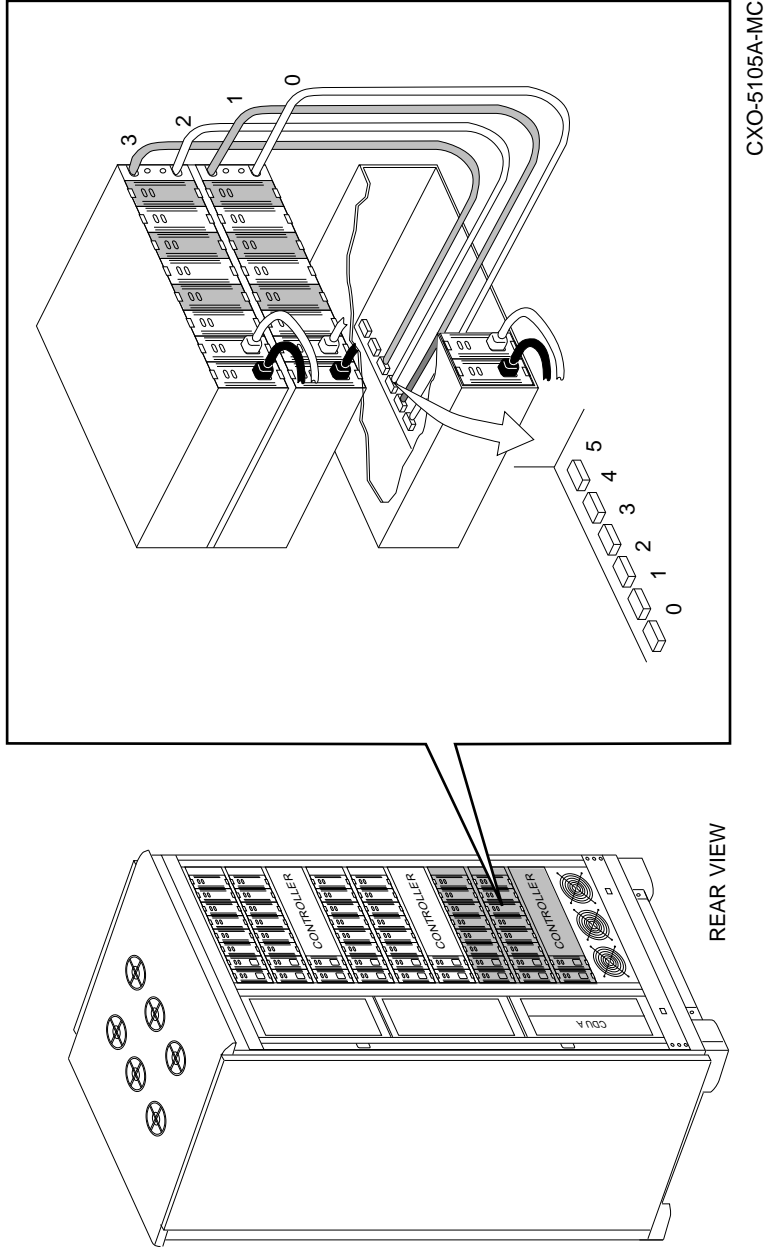

Figure 14 SW821 Storage Set 7



# SW822 Storage Cabinet

The three SW822 storage sets cable connections are shown in Figure 15 through Figure 17.

Figure 15 SW822 Storage Set 1

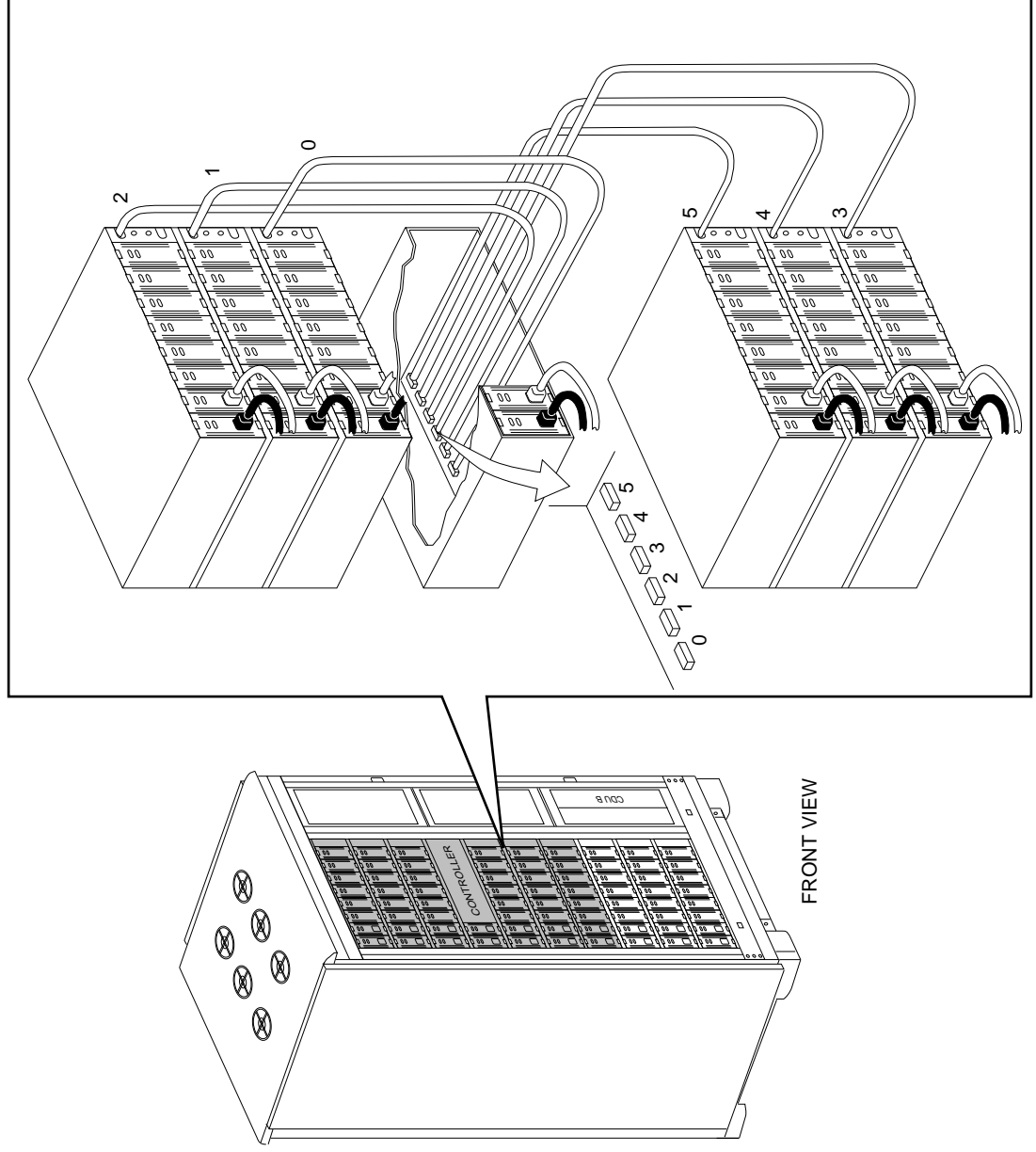

Figure 16 SW822 Storage Set 2

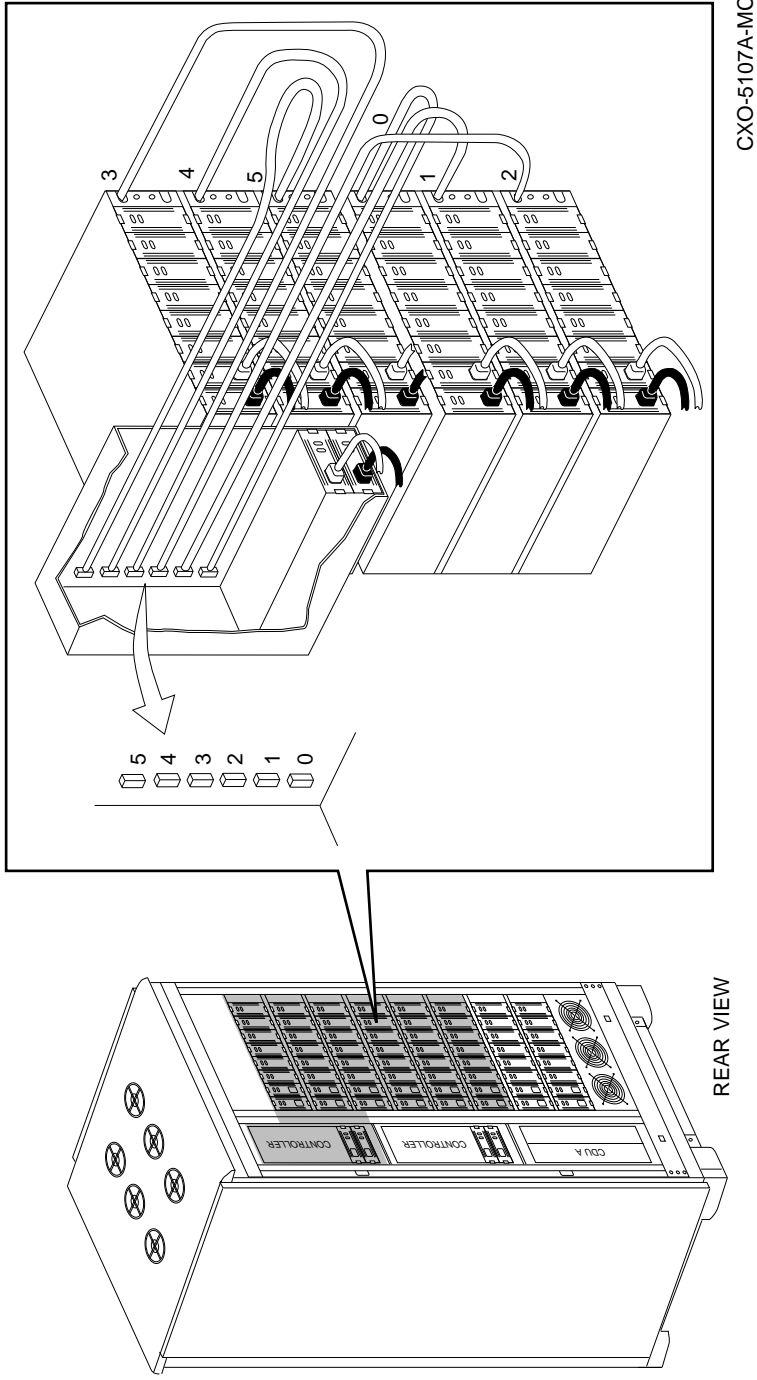
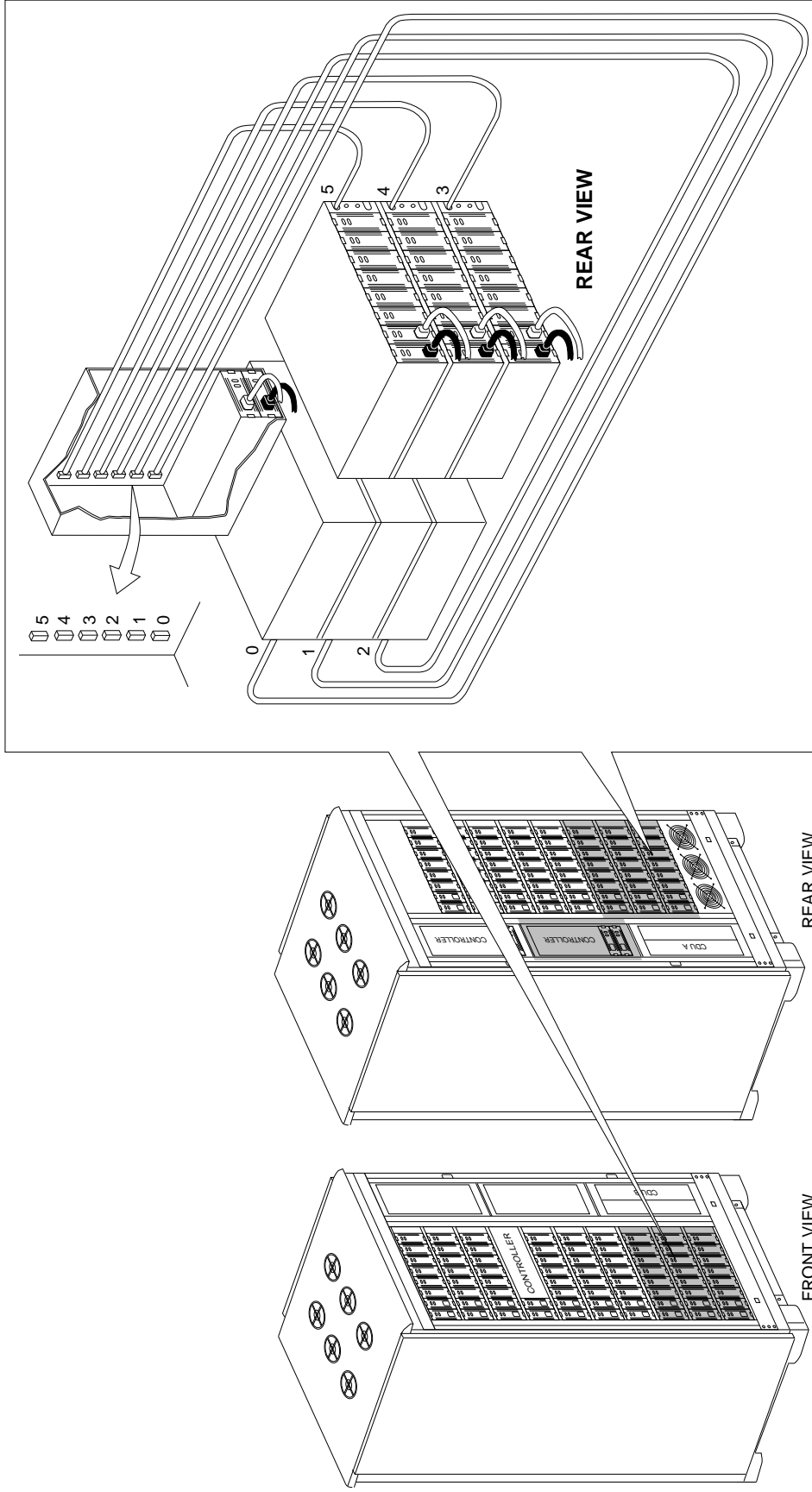

Figure 17 SW822 Storage Set 3



CXO-5108A-MC