

HSZ10-AA Controller

Site Preparation Guide

Order Number: EK-HSZ10-IN-B01

Revision/Update Information: This new document supersedes the *HSZ10-AA Controller Site Preparation Guide*, Version 1.0.

May 1993

First Printing, November 1992

The information in this document is subject to change without notice and should not be construed as a commitment by Digital Equipment Corporation. Digital Equipment Corporation assumes no responsibility for any errors that may appear in this document.

Restricted Rights: Use, duplication, or disclosure by the U.S. Government is subject to restrictions as set forth in subparagraph (c)(1)(ii) of DFARS 252.227-7013, or in FAR 52.227-19 or FAR 52.227-14, Alt. III, as applicable.

© Digital Equipment Corporation 1993.

All Rights Reserved.
Printed in the U.S.A.

The equipment described in this manual generates, uses, and may emit radio frequency energy. The equipment has been type tested and found to comply with the limits for a class A computing device pursuant to Part 15 of FCC Rules, which are designed to provide reasonable protection against such radio frequency interference when operated in a commercial environment. Operation of this equipment in a residential area may cause interference, in which case the user at his own expense may be required to take measures to correct the interference.

The postpaid READER'S COMMENTS form on the last page of this document requests the user's critical evaluation to assist in preparing future documentation.

The following are trademarks of Digital Equipment Corporation:

BA350, DEC, DECnet, DECnet-DOS, DEC RAID, DECserver, DECstation, DECwindows, OpenVMS, StorageWorks, VAX, VAXcluster, VAX DOCUMENT, VAXstation, VMS, VT, and the DIGITAL logo.

The following are third-party trademarks:

ASPI is a registered trademark of Adaptec, Inc.
DPT, SmartCache, and SmartROM are registered trademarks of Distributed Processing Technology.
Intel is a registered trademark of Intel Corporation.
MS-DOS and Microsoft are registered trademarks of Microsoft Corporation.
Novell and NetWare are registered trademarks of Novell, Inc.
RAID Manager is a trademark of NCR Corporation.
SCO is a registered trademark of The Santa Cruz Operation, Inc.
UNIX is a registered trademark of AT&T.
Windows is a trademark of Microsoft Corporation.
X Window System is a trademark of the Massachusetts Institute of Technology.

All other trademarks and registered trademarks are the property of their respective holders.

This document was prepared using VAX DOCUMENT, Version 2.1.

Contents

Preface	v
1 Introduction	
1.1 Product Description	1-1
1.2 Setting the SCSI ID on the Controller for the Array Channel ...	1-4
1.3 Setting the SCSI ID on the Controller for the Host Channel	1-4
2 How to Replace an HSZ10-AA Controller	
3 How to Add an Additional Controller	
Figures	
1-1 Diagram of the BA350-EA Shelf	1-2
1-2 Physical Layout of the HSZ10-AA Controller	1-3
1-3 SW1—SCSI ID Settings	1-4
1-4 SCSI ID Setting Examples	1-5
2-1 Removing the Front Bezel	2-2
2-2 HSZ10-AA in a BA350-EA Shelf	2-3
2-3 Removing the HSZ10-AA Controller	2-4
2-4 LED Indicators	2-5
2-5 LED Indicators for the Fully Functional State.....	2-6

Preface

Purpose

This guide describes the installation or replacement of the HSZ10-AA controller and setting the SCSI ID switches on the controller.

Intended Audience

This guide is intended for use by customers, system administrators, and Digital Customer Service Engineers responsible for installing and maintaining the HSZ10-AA controller.

Structure

This guide is organized as follows:

Chapter 1, Introduction, describes the HSZ10-AA controller, setting the SCSI ID on the controller for the array channel, setting the SCSI ID on the controller for the host channel.

Chapter 2, How to Replace an HSZ10-AA Controller, describes how to remove and replace an HSZ10-AA controller.

Chapter 3, How to Add an Additional Controller, describes how to add an additional HSZ10-AA controller.

Related Documents

The following is a list of documents that contain information related to this product:

Document Title	Order Number
<i>DEC RAID Subsystem User's Guide</i>	EK-SZ200-UG
<i>DEC RAID Utilities User's Guide</i>	EK-DECRA-UG
<i>DEC RAID OpenVMS VAX Utility User's Guide</i>	AA-PYZLA-TE
<i>DEC RAID OpenVMS VAX Utility Release Notes and Installation Guide</i>	AA-PYZUA-TE
<i>StorageWorks Shelf Building Block Subsystem Configuration Guide</i>	EK-BA350-CG
<i>BA350-EA Modular Storage Shelf Subsystem User's Guide</i>	EK-350EA-UG
<i>BA350-SA Modular Storage Shelf User's Guide</i>	EK-350SA-UG
<i>BA35X Vertical Mounting Kit User's Guide</i>	EK-BA350SV-UG

Documentation Conventions

The following is a list of the conventions used in this manual.

Convention	Description
boldface type	Indicates the first instance of terms being defined in text.
<i>italic type</i>	Indicates emphasis and complete manual titles.

1

Introduction

The HSZ10-AA controller (disk array controller board) is factory-installed and shipped in the BA350-EA shelf. The SCSI ID switches located on the HSZ10-AA controller are preset to the default setting shown in Section 1.3.

This guide describes how to do the following:

- Remove the HSZ10-AA controller.
- Set the SCSI ID switches.
- Replace the controller in the BA350-EA shelf.
- Add a controller.

This chapter contains the following information:

- Product description
- SCSI ID for the drive channels
- SCSI ID for the host channel

1.1 Product Description

The HSZ10-AA controller is an intelligent SCSI disk array controller that supports the following characteristics:

- RAID levels 0, 1, 3, and 5
- Host SCSI support: fast (10 Mbytes per second), wide (16 bits), differential SCSI-2
- Drive support: 5 Mbytes per second SCSI-2 (5 channels)
- Dimensions (form factor): 7.75 inches by 12.5 inches

Introduction
1.1 Product Description

The physical standard dimensions (form factor) of the controller are designed to fit in a BA350-EA shelf shown in Figure 1-1 in either controller slot. If there is only one controller, it should go into the top slot (or left slot if the unit is mounted in a BA35X-VA kit) shown in Figure 1-1 as "Controller 1."

Figure 1-1 Diagram of the BA350-EA Shelf

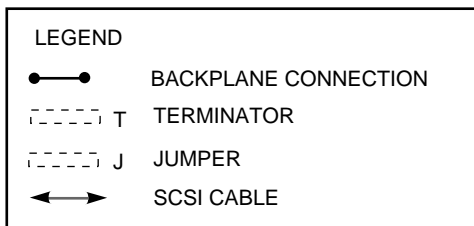
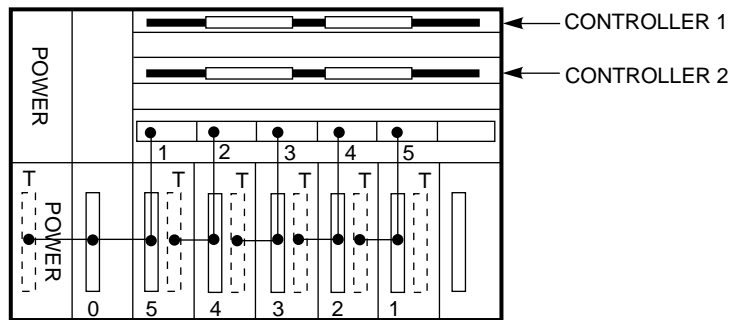

CXO-3589A-MC

The five drive SCSI buses are directly connected to the BA350-EA backplane through connectors shown as J3, J4, and J5 as shown in Figure 1-2.

Figure 1–2 Physical Layout of the HSZ10-AA Controller

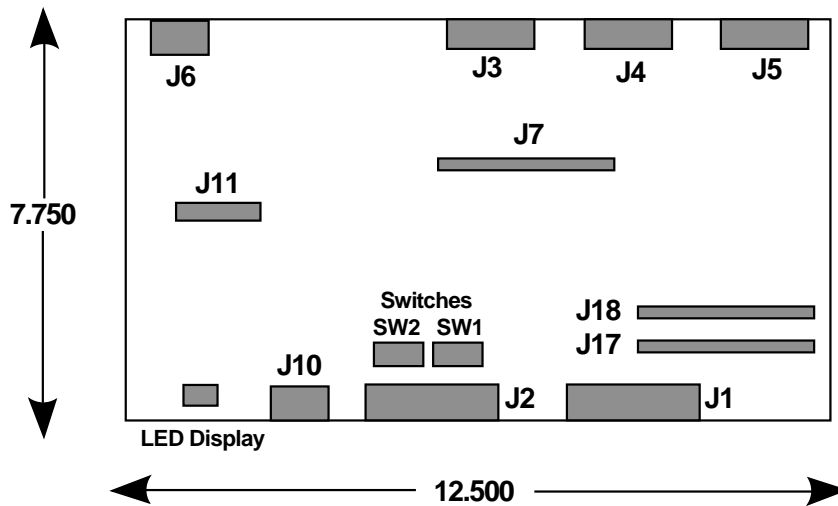

Legend			
J1	68 pin host connector	J7	drive fault signals (reserved)
J2	68 pin host connector	J10	RS232 port (reserved)
J3	2 array SCSI channels	J11	diagnostic port (reserved)
J4	2 array SCSI channels	J17	processor test port (reserved)
J5	1 array SCSI channel	J18	processor test port (reserved)
J6	subsystem signals		
	SW1	SCSI switches	
	SW2	manufacturing switches (reserved)	

SHR–XR3003–GRA

Connection to the host SCSI bus is through the 68-pin P-cable SCSI connections. Either the J1 or the J2 connector can be used. Whichever connector is not used is available for either daisy chaining to another HSZ10-AA controller or terminating the SCSI bus with the terminator provided.

An LED display is used for status information for the controller. A handle is provided for shielding as well as user convenience during removal and insertion of the HSZ10-AA controller.

Two captive screws secure the controller into the BA350-EA shelf.

Introduction

1.2 Setting the SCSI ID on the Controller for the Array Channel

1.2 Setting the SCSI ID on the Controller for the Array Channel

The SCSI ID of the controller used on the drive bus is determined by the controller slot of the BA350-EA shelf backplane. If the controller is placed in the Controller 1 slot, then the SCSI ID is 7. If the controller is placed in the Controller 2 slot, then the SCSI ID is 6.

1.3 Setting the SCSI ID on the Controller for the Host Channel

The SCSI ID on the host channel is set by using SW1 as shown in Figure 1-3.

Figure 1-3 SW1—SCSI ID Settings

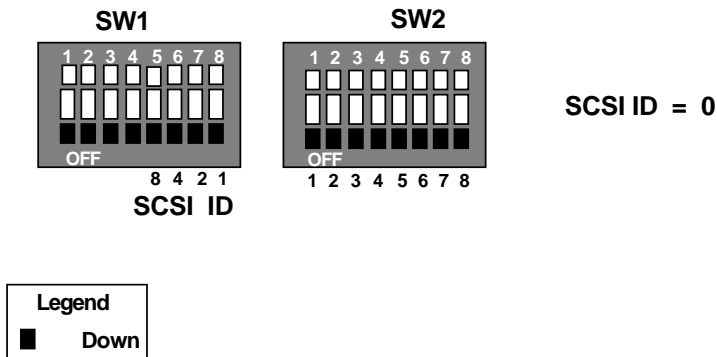

SHR-XR3020-GRA

By default, the switch is set to SCSI ID 0, as shown in Figure 1-3. The SCSI ID can be set to any value between 0 and 15. To change the default SCSI ID, you must remove the HSZ10-AA controller from the BA350-EA shelf, and then set the SCSI ID. The procedure for removing the controller is described in Chapter 2.

Figure 1-4 shows examples of SCSI ID 4, 6, and 12.

1.3 Setting the SCSI ID on the Controller for the Host Channel

Figure 1-4 SCSI ID Setting Examples

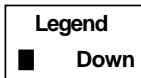
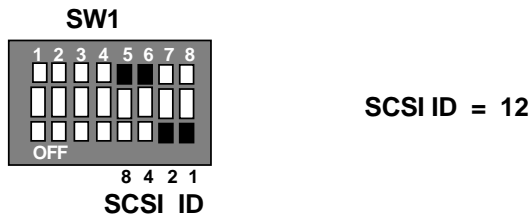
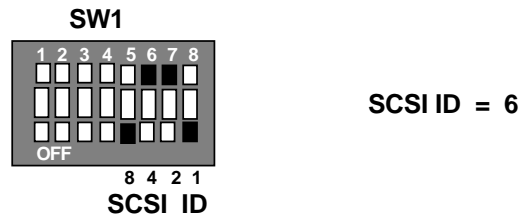
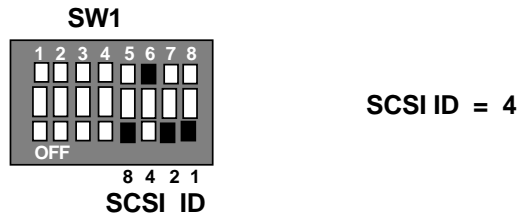

SHR-XR3021-GRA

Note

If the HSZ10-AA controller is to be used with 8-bit devices on the host SCSI bus, then the SCSI IDs of the controller should be restricted to between 0 and 7.

2

How to Replace an HSZ10-AA Controller

Do following steps to replace an HSZ10-AA controller board.

Caution

To avoid unnecessary static damage, follow adequate antistatic procedures when handling HSZ10-AA controllers.

If the unit is mounted as a part of a vertical mounting kit (BA35X-VA), then the cabinet door and front bezel should be removed as shown in Figure 2-1. The procedure is described in the *BA35X-VA Vertical Mounting Kit User's Guide*. After you open the cabinet door, press down on the plastic clips at the base of the bezel and pull the bezel toward you.

How to Replace an HSZ10-AA Controller

Note that Figure 2-1 shows the removal of the front drive bezel. Remove the front shelf bezel in the same way that you would remove the drive bezel.

Figure 2-1 Removing the Front Bezel

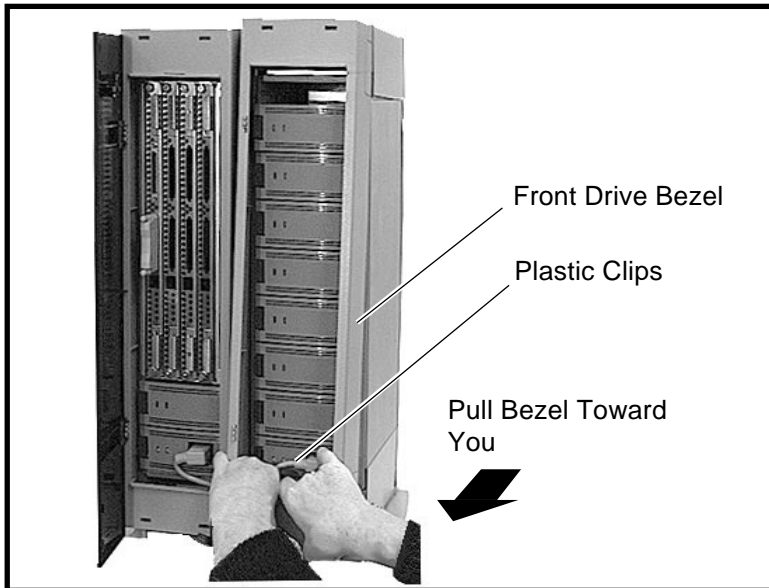

SHR-XR3003-VIF

1. Power down the subsystem.
2. Loosen the captive slotted screws shown in Figure 2-2 on the host connector cable and remove the cable from the HSZ10-AA controller.

How to Replace an HSZ10-AA Controller

Figure 2-2 HSZ10-AA in a BA350-EA Shelf

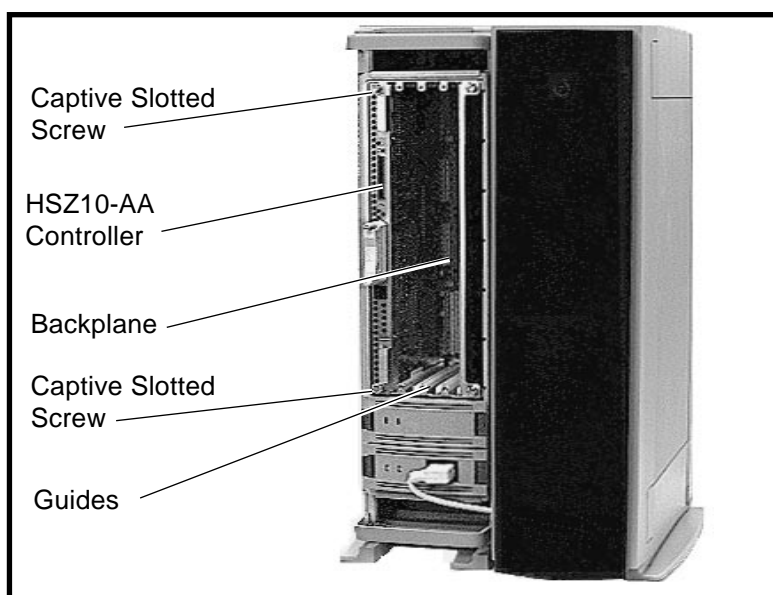

3. Use a screwdriver to loosen the large captive screws at the top and bottom of the panel on the BA350-EA shelf to free the HSZ10-AA controller board. You do not have to remove the terminator by unscrewing its thumb screws. That is optional.
4. Carefully remove the new controller board from the antistatic bag.

_____ **Warning** _____

The surfaces of the board are rough and the edges are sharp. Place the board down gently.

5. The existing controller board was loosened in Step 2. Remove the HSZ10-AA controller board by pulling the handles straight toward you and sliding the board along the guide inside the cabinet shown in Figure 2-3.

How to Replace an HSZ10-AA Controller

Figure 2-3 Removing the HSZ10-AA Controller

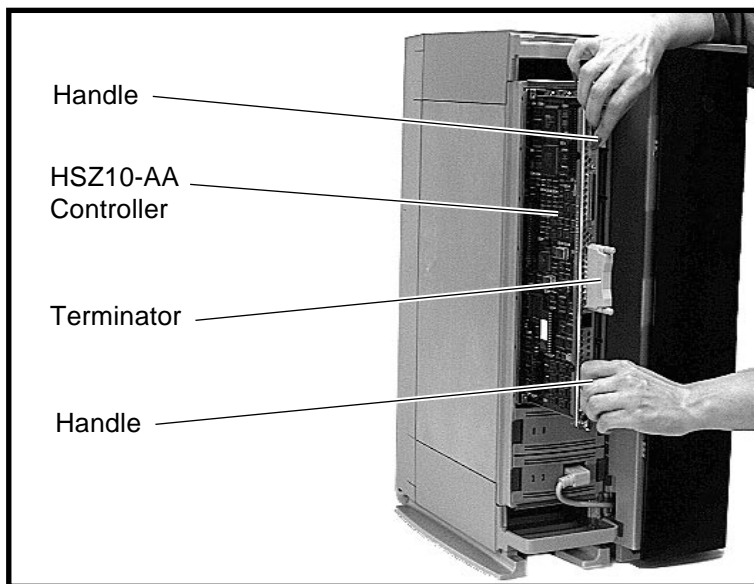

SHR-XR3004-VIF

Note that the controller board fits tightly within the shelf. When the board is free of the cabinet, make note of the SCSI ID of the original controller board.

You can put the original board in the empty antistatic bag that came with the new controller board. If you are replacing the HSZ10-AA controller board because of a defect, place the board in the shipping box and send it to your Digital Customer Service Center for repair or credit.

6. Set the SCSI ID of the replacement controller board to that of the original controller. Slide the new controller into the slot that the original controller came out of using the guides provided. The board must be properly seated. It should snap into place and sit flush within the cabinet before you start to secure the controller by tightening the captive screws.
7. Re-attach the host SCSI cable and terminator as necessary.
8. Power on the subsystem.

How to Replace an HSZ10-AA Controller

9. If the power is on, then the controller shows the green power light and the "Heartbeat" LED next to it and at the other end of the LED indicator is an LED value of 5. See Figure 2-4.

Figure 2-4 LED Indicators

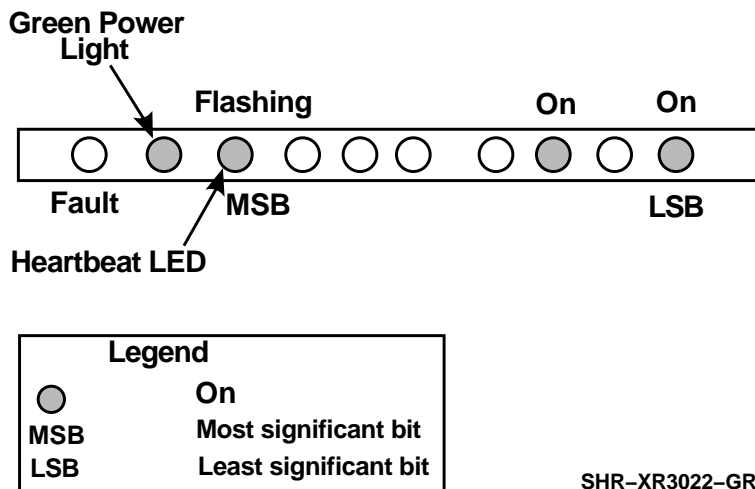

How to Replace an HSZ10-AA Controller

Figure 2-5 shows the new LED indicators.

Figure 2-5 LED Indicators for the Fully Functional State

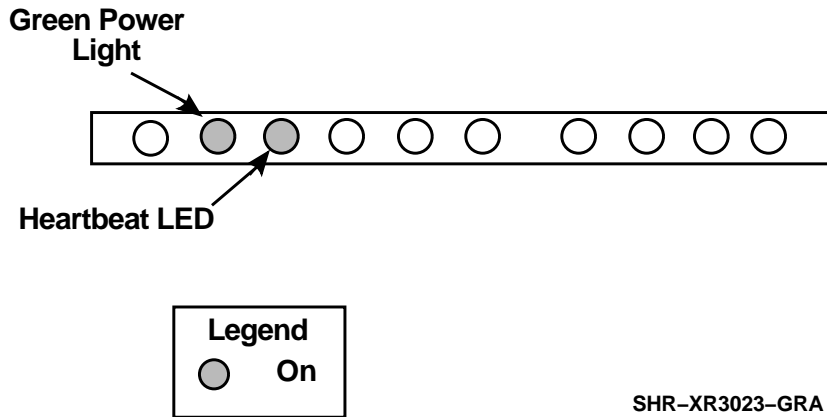

If the LED does not appear as shown in Figure 2-5, then refer to Chapter 6, *Operations* and Chapter 8, *Error Handling/Troubleshooting* in the *DEC RAID Subsystem User's Guide*.

10. If the unit is contained in a vertical mounting kit, then replace the bezel. Refer to the *BA35X-VA Vertical Mounting Kit User's Guide* for details.

3

How to Add an Additional Controller

Follow these steps to add a controller:

1. If two controllers are to be daisy chained together on the same SCSI bus, then set the SCSI ID of the new controller so that it does not conflict with the existing controller.
2. Slide the controller into the empty slot shown as “Controller 2” in Figure 1–1 and secure it in place using the thumb screws.
3. Connect to the existing controller and/or to the host using the appropriate cable provided.

Note

An additional controller will be in a *passive* state.

The additional controller can only be taken out of this state by using a host adapter/operating system environment that can use a redundant controller configuration. Such a configuration is not yet supported.
