

# DIGITAL VNswitch 900XA

---

## Installation and Configuration

Part Number: EK-DVNXA-IN. A01

**August 1997**

This manual describes how to install and configure the DIGITAL VNswitch 900XA.

**Revision/Update Information:** This is a new document.

Digital Equipment Corporation makes no representations that the use of its products in the manner described in this publication will not infringe on existing or future patent rights, nor do the descriptions contained in this publication imply the granting of licenses to make, use, or sell equipment or software in accordance with the description.

Possession, use, or copying of the software described in this publication is authorized only pursuant to a valid written license from DIGITAL or an authorized sublicensor.

© Digital Equipment Corporation 1997. All rights reserved. Printed in U.S.A.

The following are trademarks of Digital Equipment Corporation: clearVISN, the clearVISN logo, DEC, DECconnect, DEChub, DIGITAL, and the DIGITAL logo.

All other trademarks and registered trademarks are the property of their respective holders.

**FCC Notice** — Class A Computing Device:

This equipment generates, uses, and may emit radio frequency energy. The equipment has been type tested and found to comply with the limits for a Class A digital device pursuant to Part 15 of FCC rules, which are designed to provide reasonable protection against such radio frequency interference.

Operation of this equipment in a residential area may cause interference in which case the user at his own expense will be required to take whatever measures may be required to correct the interference. Any modifications to this device - unless expressly approved by the manufacturer - can void the user's authority to operate this equipment under part 15 of the FCC rules.

**VCCI Notice** — Class 1 Computing Device:

This equipment is in the 1st Class category (information equipment to be used in commercial and/or industrial areas) and conforms to the standards set by the Voluntary Control Council for Interference by Data Processing Equipment and Electronic Office Machines aimed at preventing radio interference in commercial and/or industrial areas. Consequently, when used in a residential area or in an adjacent area thereto, radio interference may be caused to radios and TV receivers. Read the instructions for correct handling.

**CE Notice** — Class A Computing Device:

**Warning!**

This is a Class A product. In a domestic environment, this product may cause radio interference, in which case the user may be required to take adequate measures.

**Achtung!**

Dieses ist ein Gerät der Funkstörgrenzwertklasse A. In Wohnbereichen können bei Betrieb dieses Gerätes Rundfunkstörungen auftreten, in welchen Fällen der Benutzer für entsprechende Gegenmaßnahmen verantwortlich ist.

**Avertissement!**

Cet appareil est un appareil de Classe A. Dans un environnement résidentiel cet appareil peut provoquer des brouillages radioélectriques. Dans ce cas, il peut être demandé à l'utilisateur de prendre les mesures appropriées.

# Contents

---

## Preface

Overview .....	ix
Purpose of This Manual .....	ix
Intended Audience .....	ix
Organization .....	x
Conventions and Terms .....	xi
Conventions .....	xi
Terms Used in This Manual .....	xi
Associated Documents .....	xii
Correspondence .....	xiv
Documentation Comments .....	xiv
Online Services .....	xiv
How to Order Additional Documentation .....	xv

## Safety

Overview .....	xvii
Precautions .....	xviii

## 1 Product Introduction

Overview .....	1-1
Introduction .....	1-1
In This Chapter .....	1-1
What Is the DIGITAL VNswitch 900XA? .....	1-2
Features .....	1-3
Hot Swap .....	1-3
Configuration and Management .....	1-3
Bridging .....	1-4
Ethernet .....	1-4
ATM .....	1-4

SNMP . . . . .	1-5
VLAN Secure Domain . . . . .	1-6

## 2 Installing Modular Media Interface Cards

Overview . . . . .	2-1
Introduction . . . . .	2-1
In This Chapter . . . . .	2-1
Installation Preparation . . . . .	2-2
Required Tools . . . . .	2-2
Removing the Slot Cover . . . . .	2-3
Installing the Card . . . . .	2-4
Removing the Card . . . . .	2-6

## 3 Installing the DIGITAL VNswitch 900XA

Overview . . . . .	3-1
Introduction . . . . .	3-1
In This Chapter . . . . .	3-1
Module Components . . . . .	3-2
Front Panel Components . . . . .	3-3
Back Panel Components . . . . .	3-6
How to Install the Module . . . . .	3-8
Task 1: Compare the Power Ratings . . . . .	3-8
Task 2: Seat the Module . . . . .	3-9
Task 3: Verify Initial LED Operation . . . . .	3-10
Task 4: Connect the LDM Port Cable . . . . .	3-11

## 4 Installing the Setup Port Cable

Overview . . . . .	4-1
Introduction . . . . .	4-1
In This Chapter . . . . .	4-1
Setup Port Signaling Standards . . . . .	4-2
Setup Port Device Cabling . . . . .	4-3
Connecting to the Setup Port . . . . .	4-4

## 5 Configuring the Module in a DEChub ONE

Overview .....	5-1
Introduction.....	5-1
In This Chapter .....	5-1
Assigning an IP Address .....	5-2
Using Menus to Configure the Module .....	5-3
[1] Restart with Factory Defaults.....	5-4
[2] Restart with Current Settings .....	5-5
[3] Show Current Settings .....	5-6
[4] Configure IP .....	5-7
[1] Set SNMP Read/Write Community .....	5-8
[2] Set In-Band Interface IP Address .....	5-9
[3] Set Out-of-Band Interface IP Address .....	5-10
[4] Set Default Gateway .....	5-11
[5] Go to Local Console.....	5-12
[6] Product-Specific Options .....	5-13

## 6 Configuring the Module in a DIGITAL MultiSwitch 900

Overview .....	6-1
Introduction.....	6-1
In This Chapter .....	6-1
Assigning an IP Address .....	6-2
DEChub 900 MultiSwitch INSTALLATION MENU.....	6-3
[9] Start Redirect Mode .....	6-4
Using Menus to Configure the Module .....	6-5
[1] Restart with Factory Defaults.....	6-6
[2] Restart with Current Settings .....	6-7
[3] Show Current Settings .....	6-8
[4] Configure IP .....	6-9
[1] Set SNMP Read/Write Community .....	6-10
[2] Set In-Band Interface IP Address .....	6-11
[3] Set Out-of-Band Interface IP Address .....	6-12
[4] Set Default Gateway .....	6-13
[5] Go to Local Console.....	6-14
[6] Product-Specific Options (VNswitch 900XA).....	6-15
[10] Product-Specific Options (DIGITAL MultiSwitch 900) .....	6-16

## 7 Removing the Module

Overview . . . . .	7-1
Introduction . . . . .	7-1
In This Chapter . . . . .	7-1
Removing the Cables . . . . .	7-2
Unseating the Module . . . . .	7-3

## A Problem Solving

Overview . . . . .	A-1
Introduction . . . . .	A-1
In This Appendix . . . . .	A-1
Normal Power-Up . . . . .	A-2
LED Descriptions . . . . .	A-3
Problem Solving Using LEDs . . . . .	A-5

## B Connectors and Adapters

Overview . . . . .	B-1
Introduction . . . . .	B-1
In This Appendix . . . . .	B-1
Connectors and Pin Assignments . . . . .	B-2
10BaseT (8-pin MJ) Straight-Through Connector . . . . .	B-2
Adapters . . . . .	B-3
H8571-J Adapter . . . . .	B-3
H8575-A Adapter . . . . .	B-3

## C Product Specifications

Overview . . . . .	C-1
Introduction . . . . .	C-1
In This Appendix . . . . .	C-1
Product Specifications . . . . .	C-2
Acoustical Specifications . . . . .	C-3
Connectors . . . . .	C-4

## Figures

2-1	Removing the Slot Cover . . . . .	2-3
2-2	Installing the Card . . . . .	2-5
2-3	Removing the Card . . . . .	2-7
3-1	Front Panel LEDs and Connectors . . . . .	3-5
3-2	Back Panel Layout . . . . .	3-7
3-3	Power Ratings . . . . .	3-8
3-4	Seating the Module . . . . .	3-9
3-5	LDM Port Cable Connection . . . . .	3-11
4-1	Setup Port Cabling Components . . . . .	4-5
7-1	Removing the LDM Port Cable . . . . .	7-2
7-2	Unseating the Module . . . . .	7-3
B-1	100BaseTX 8-Pin MJ Connector . . . . .	B-2
B-2	H8571-J Adapter . . . . .	B-3
B-3	H8575-A Adapter . . . . .	B-3

## Tables

3-1	Front Panel LEDs and Connectors . . . . .	3-3
3-2	Back Panel Components . . . . .	3-6
A-1	Module LED States . . . . .	A-3
A-2	Problem Solving Using the LEDs . . . . .	A-5
B-1	8-pin MJ Straight-Through Connector Pin Assignments . . . . .	B-2
C-1	Product Specifications . . . . .	C-2
C-2	English Acoustical Specifications . . . . .	C-3
C-3	German Acoustical Specifications . . . . .	C-3
C-4	Connectors . . . . .	C-4





---

# Preface

---

## Overview

### Purpose of This Manual

This manual describes how to install and set up the DIGITAL VNswitch 900XA module and install ATM Modular PHY (modPHY) cards and 100 Mb/s Fast Ethernet Modular Media Interface (MM-100) cards. It also provides problem solving, connector and adapter, and pin assignment information.

### Intended Audience

This manual is intended for use by personnel who will install and set up the VNswitch 900XA module.

## Organization

This manual is organized as follows:

<b>Section</b>	<b>Description</b>
Chapter 1	Provides an overview of the VNswitch 900XA module and describes its features.
Chapter 2	Provides information on installing and removing Modular Media Interface (MMI) cards.
Chapter 3	Provides instructions for installing the VNswitch 900XA in a DIGITAL MultiSwitch 900 (formerly DEChub 900 MultiSwitch).
Chapter 4	Provides instructions for installing the setup port cable on the DEChub ONE docking station and the DIGITAL MultiSwitch 900 (formerly DEChub 900 MultiSwitch).
Chapter 5	Provides information on setting up and configuring the VNswitch 900XA in a DEChub ONE docking station.
Chapter 6	Provides information on how to configure when the VNswitch 900XA is installed in a DIGITAL MultiSwitch 900 (formerly DEChub 900 MultiSwitch).
Chapter 7	Provides information on how to remove the VNswitch 900XA from the DIGITAL MultiSwitch 900 (formerly DEChub 900 MultiSwitch).
Appendix A	Provides installation-specific problem solving information using the LEDs.
Appendix B	Provides information about connectors, adapters, and pin assignments for the VNswitch 900XA module.
Appendix C	Provides product specifications.

---

---

## Conventions and Terms

### Conventions

This manual uses the following conventions:

Convention	Description
<b>NOTE</b>	Contains information of special interest.
<i>Special Type</i>	Indicates system output in examples.
<b>Boldface</b>	Indicates user input in examples.
<Return>	Indicates that you should press the Return key.

### Terms Used in This Manual

This book uses the following terms:

Term	Definition
ATM	Asynchronous Transfer Mode, a data transmission technology viable for both local and wide area networks (WANs). Provides high-speed data transmission rates.
Ethernet	The DIGITAL term for its product compatibility with ISO 8802-3/ANSI/IEEE 802.3 standards and the Ethernet standards for CSMA/CD local area networks (LANs).
modPHY	ATM Modular Media Interface, front-insertable, hot-swappable, single-slot option interface card.
ScTP Cable	A 100 ohm cable that supports 10BaseT- and 100BaseT-compliant products.
SNMP	Simple Network Management Protocol, an industry-standard protocol for network management

---

## Associated Documents

The following documents provide information relating to the VNswitch 900XA. To order any of the following documents, refer to the directions in the How to Order Additional Documentation section.

<b>Title and Order Number</b>	<b>Description</b>
<i>DEChub 900 MultiSwitch Owner's Manual</i> EK-DH2MS-OM	Provides installation, use, security, and troubleshooting information for the DEChub 900 MultiSwitch <sup>1</sup> .
<i>DEChub ONE Installation</i> EK-DEHU2-IN	Provides installation and operation guidelines for standalone module configuration, including mounting options and cabling.
<i>DEChub ONE-MX Installation</i> EK-DEF1H-IN	Provides installation and operation guidelines for standalone module configuration, including mounting options and cabling.
<i>clearVISN Installation</i>	Provides pre- and post-installation information, as well as actual installation procedures for each application.
<i>clearVISN Overview</i>	Provides an overview of the clearVISN software, an explanation of each application, and descriptions of all concepts necessary to understand and use the application efficiently.
<i>clearVISN User's Guide</i>	Provides information for starting and configuring each application, and general use information.
<i>VNswitch 900 Series Technical Overview</i>	Provides a technical overview of the VNswitch 900 family of high-density switching products.
<i>VNswitch 900 Series Switch Management</i>	Describes how to configure, monitor, and manage a VNswitch 900 module.
<i>OPEN DECconnect Applications Guide</i> EC-G2570-42	Provides information to help plan and install networking systems based on the DIGITAL OPEN DECconnect System and networking products.

## Associated Documents

<b>Title and Order Number</b>	<b>Description</b>
<i>Event Logging System Messages Guide</i>	Describes messages logged by the Event Logging System.
<i>Bridge and Extended LAN Reference</i> EK-DEBAM-HR	Describes how bridges are used to create extended local area networks (LANs). The descriptions include the use of bridges in extended LAN configurations, information on LAN interconnections, overall bridge operation, spanning tree, bridge management, and solving bridge-related problems in a network.
<i>ATM Modular PHY Cards Installation</i> EK-DAGGM-IN	Provides installation and operating guidelines for installing, verifying, and removing Modular PHY cards. Describes cabling and light-emitting diode (LED) information.
<i>100 Mb/s Fast Ethernet Modular Media Interface Cards Installation</i> EK-MBITM-IM	Provides installation and operating guidelines for installing, verifying, and removing MM-100 Modular Media Interface cards. Describes cabling and LED information.

1. The title of this book will change to reflect the product name change from DEChub 900 MultiSwitch to DIGITAL MultiSwitch 900.

## Correspondence

### Documentation Comments

If you have comments or suggestions about this document, send them to the Network Products Business Organization.

Attn: Documentation Project Manager  
FAX: (508) 486-6093  
E-MAIL: doc\_feedback@lkg.mts.dec.com

### Online Services

To locate product-specific information, refer to the following online services:

**BBS** To read the Bulletin Board System, set your modem to 8 bits, no parity, 1 stop bit and dial 508-486-5777 (U.S.).

**WWW** The Digital Equipment Corporation Network Products Business Home Page on the World Wide Web is located at the following addresses:

**North America:** <http://www.networks.digital.com>

**Europe:** <http://www.networks.europe.digital.com>

**Australia:** <http://www.digital.com.au/networks>

---

## How to Order Additional Documentation

To order additional documentation, use the following information:

---

<b>To Order:</b>	<b>Contact:</b>
By Telephone	Continental U.S.A.: 1-800-DIGITAL (1-800-344-4825) Canada: 1-800-267-6215 Alaska, New Hampshire, and Hawaii: 1-603-884-6660
Electronically (U.S.A. only)	Dial 1-800-DEC-DEMO (For assistance, call 1-800-DIGITAL)
By Mail (U.S.A. and Puerto Rico)	DIGITAL EQUIPMENT CORPORATION P.O. Box CS2008 Nashua, New Hampshire 03061 (Place prepaid orders from Puerto Rico with the local DIGITAL subsidiary: 809-754-7575)
By Mail (Canada)	DIGITAL EQUIPMENT CORPORATION LTD. 940 Belfast Road Ottawa, Ontario, Canada K1G 4C2 Attn: A&SG Business Manager
Internationally	DIGITAL EQUIPMENT CORPORATION A&SG Business Manager c/o local DIGITAL subsidiary or approved distributor
Internally	U.S. Software Supply Business (SSB) DIGITAL EQUIPMENT CORPORATION 8 Cotton Road Nashua, New Hampshire 03063

---





---

# Safety

---

## Overview

The cautions that must be observed for the hardware described in this manual are listed in this section in English, German, French, and Spanish. Any warning or caution that appears in this manual is defined as follows:

<b>WARNING</b>	Contains information to prevent personal injury.
<b>CAUTION</b>	Contains information to prevent damage to equipment.
<b>VORSICHT</b>	Enthält Informationen, die beachtet werden müssen um den Benutzer vor Schaden zu bewahren.
<b>ACHTUNG</b>	Enthält Informationen, die beachtet werden müssen um die Geräte vor Schaden zu bewahren
<b>DANGER</b>	Signale les informations destinées à prévenir les accidents corporels.
<b>ATTENTION</b>	Signale les informations destinées à prévenir la détérioration du matériel.
<b>AVISO</b>	Contiene información para evitar daños personales.
<b>PRECAUCIÓN</b>	Contiene información para evitar daños al equipo.

---

## Precautions

---

<b>CAUTION</b>	This action deletes all configured settings and replaces them with factory default values. All configuration settings will be lost.
<b>ACHTUNG</b>	Bei diesem Vorgang werden alle Konfigurationseinstellungen gelöscht und die Werkseinstellungen wieder eingesetzt. Alle Konfigurationsdaten gehen verloren.
<b>ATTENTION</b>	Cette action supprime tous les paramètres de configuration et les remplace par des valeurs prédéfinies. Tous les paramètres de configuration seront perdus.
<b>PRECAUCIÓN</b>	Esta intervención borrará todos los parámetros de configuración y los sustituirá por valores por defecto definidos de fábrica. Se perderán todos los parámetros de configuración.

---

<b>CAUTION</b>	Static electricity can damage modules and electronic components. DIGITAL recommends using a grounded antistatic wrist strap and a grounded work surface when handling any modules.
<b>ACHTUNG</b>	Module und elektronische Komponenten können durch elektrostatische Entladungen beschädigt werden. Benutzen Sie immer eine antistatische Gelenkmanschette und eine geerdete Arbeitsunterlage, wenn Sie am offenen Gerät arbeiten.
<b>ATTENTION</b>	Les charges excessives d'électricité statique peuvent endommager les modules et les composants électroniques. DIGITAL conseille l'utilisation d'un bracelet de masse et d'un plan de travail mis à la terre lors de la manipulation des modules.
<b>PRECAUCION</b>	La electricidad estática puede dañar los componentes electrónicos y los módulos. DIGITAL recomienda que se utilicen cintas de pasadores y superficies de trabajo conectadas a tierra al trabajar con cualquier módulo.

---

# Chapter 1

---

## Product Introduction

---

### Overview

#### Introduction

This chapter describes the features of the DIGITAL VNswitch 900XA module.

For further technical information on the VNswitch 900XA, refer to the *VNswitch 900 Series Switch Management* and the *VNswitch 900 Series Technical Overview*.

#### In This Chapter

This chapter consists of the following topics:

Topic	Page
What Is the DIGITAL VNswitch 900XA?	1-2
Features	1-3

What Is the DIGITAL VNswitch 900XA?

---

## What Is the DIGITAL VNswitch 900XA?

The VNswitch 900XA (also referred to in this manual as the module) is a high-throughput, Simple Network Management Protocol (SNMP) manageable, multiport network switch for linking Fast Ethernet and Asynchronous Transfer Mode (ATM) networks. It transparently converts Media Access Control (MAC) frames into ATM cells and vice versa.

The module supports the front-insertable Fast Ethernet (MM-100) and ATM (modPHY) cards, which are part of the Modular Media Interface (MMI) family. The MM-100 card supports both 100BaseTX (UTP-5 with 8-pin MJ connectors) and 100BaseFX (multimode fiber-optics with SC connectors) Fast Ethernet media standards. The ATM 155 Mb/s modPHY card offers multimode fiber, single-mode fiber, or UTP-5 connectors.

The module is auto-configured to connect to the 400 Mb/s VNbus, which provides interoperability across the backplane with other VNswitch modules while maintaining front panel connectivity.

The VNswitch 900XA network module is a true backbone network switch that supports complete filtering capabilities (including source address, destination address, protocol type, and VLAN) for greater network control, increased security and bandwidth utilization, and reduced propagation of network problems.

The module includes a large address table (approximately 8,000 entries) and is fully IEEE 802.1d standards-compliant, ensuring high performance and packet integrity required in large switched networks.

The VNswitch 900XA module also offers nonvolatile flash memory for easy, non-disruptive upgrades of the device firmware using the Trivial File Transfer Protocol (TFTP) load protocol. This eliminates the need to replace or upgrade hardware in the future, and avoids the associated costs and disruption to network users. You can install and configure the module in a DIGITAL MultiSwitch 900 (formerly DEChub 900 MultiSwitch), also referred to in this manual as a MultiSwitch 900, or as a standalone unit in a DEChub ONE or DEChub ONE-MX docking station. (See the *DEChub ONE Installation* manual or the *DEChub ONE-MX Installation* manual.) The module is fully interoperable with other modules when installed in the DEChub 900 (including both MultiSwitch 900 and DEChub 90 modules).

The VNswitch 900XA does not support the Fiber Distributed Data Interface (FDDI) features of the DEChub ONE-MX.

---

## Features

This section describes the features of the VNswitch 900XA. For further information, refer to the *VNswitch 900 Series Technical Overview*.

### Hot Swap

With hot-swapping capabilities, you can perform the following functions without turning off the power:

- Install or remove the module from a DIGITAL MultiSwitch 900
- Install or remove MM-100 and ATM modPHY<sup>1</sup> cards from the module

### Configuration and Management

The following configuration and management options are available:

- Auto-configuring at power-up.
- Support for up to 256 internal addresses for management and other purposes.
- Manageable via SNMP or the Command Line Interface (CLI) management via Telnet or an attached terminal device, or both.
- Upgradeable device firmware (in nonvolatile flash memory) using TFTP with clearVISN Flash Loader or in the DEChub ONE through the OBM port with any TFTP server.
- Features a built-in SNMP management agent. It supports a comprehensive graphical user interface (GUI), using the DIGITAL clearVISN MultiChassis Manager, that is identical for both in-band and out-of-band management.
- Support for up to approximately 8,000 network addresses.
- Support of a Load/Dump/Management (LDM) port that allows upline dumps and downline loads of operational images.
- Provides user-configured rate limiting for broadcast and multicast packets by address and specified protocol.
- Supports backplane LANs by allowing the ATM ports to be directed (through management software, such as clearVISN MultiChassis Manager) to the MultiSwitch 900 backplane.
- May be used with other VNswitch 900 modules to create various configurations involving Ethernet, Fast Ethernet, FDDI, and ATM by connecting over the 400 Mb/s VNbus.

---

1. Refer to the VNswitch 900 Series Modules release notes for information on the support of this feature.

## Features

### Bridging

The following bridging features and options are available:

- High-speed, local traffic filtering and forwarding
- Full line-rate bridge forwarding – up to 750,000 packets-per-second per module
- Spanning tree loop detection protocol, IEEE 802.1d compliant
- Support for multiple spanning trees with the ability to turn off spanning tree algorithm on individual switch ports on a per-port basis

### Ethernet

The VNswitch 900XA provides half- and full-duplex operation over all Fast Ethernet ports.

### ATM

The following ATM features are available:

- Support for ATM 155 Mb/s port to be directed to chassis backplane or front panel modPHY
- Supports up to 16 ATM Forum LAN Emulation (LANE) clients (also called emulated LAN or ELANs)
- Supports up to 16 virtual ports over the ATM physical port for various combinations of LANE and bridge tunnels
- Supports flow control over the ATM link (using FLOWmaster)<sup>2</sup>
- Supports up to 1024 Virtual Circuits per physical ATM port (UNI 3.0 and 3.1)
- Supports 4 ATM Virtual Paths (VPI=0, plus three non-zero VPs) for connection to public ATM networks<sup>2</sup>

---

<sup>2</sup>. Refer to the VNswitch 900 Series Modules release notes for information on the support of this feature.

## SNMP

The VNswitch 900XA has a built-in SNMP agent and manageability that uses any generic SNMP management application.

- The following MIBs are supported:
  - MIB-II (RFC 1213)
  - Interfaces Group of MIB-II (RFC 1573)
  - Bridge MIB (RFC 1493)
  - Draft of IETF 802.3 MAU MIB
  - DEC VLAN V1 MIB
  - DIGITAL/Proteon Comet MIB
  - DEChub 900 Public Common MIB
  - DEChub Internal Common MIB
  - DIGITAL Extended LAN MIB
  - DS3/E3 MIB (RFC1407)
  - Ethernet MIB (1643)
  - SONET MIB (RFC 1595)
  - AToM MIB (RFC 1695)
  - LAN Emulation Client MIB
  - ATM Interim Local Management Interface MIB
  - DIGITAL ATM Extensions
  - DIGITAL ATM Bridge Tunnel MIB
- SNMP support for GETs and for the following standard traps, along with many proprietary traps:
  - coldStart
  - warmStart
  - linkUp
  - linkDown
- Manageability using any generic SNMP management application that supports the MIBs previously listed.

## Features

### **VLAN Secure Domain**

The VLAN Secure Domain (VSD) support has the following features:

- Ability to group ports into VSDs
- Ability to join VSDs in the MultiSwitch 900 with ATM emulated LANs
- Ability to join VSDs in different VNswitch modules across the VNbus
- Support of port groups within a MultiSwitch 900 to create larger distributed multicast domains
- Support for as many as 63 port-based VSDs across each VNbus
- Support for multiple spanning trees per module, one per VSD

For further information, refer to the *clearVISN User's Guide*, the *clearVISN Overview* manual, or the *VNswitch 900 Series Technical Overview* manual.



## Chapter 2

---

# Installing Modular Media Interface Cards

---

## Overview

### Introduction

This chapter explains how to install a 100 Mb/s Fast Ethernet Modular Media Interface (MM-100) card or an ATM Modular PHY (modPHY) card into the module. The installation and removal instructions in this chapter are applicable to all cards.

For detailed information on available cards, refer to either the *100 Mb/s Fast Ethernet Modular Media Interface Cards Installation* manual or the *ATM Modular PHY Cards Installation* manual.

### In This Chapter

Topic	Page
Installation Preparation	2-2
Removing the Slot Cover	2-3
Installing the Card	2-4
Removing the Card	2-6

## Installation Preparation

To prepare to install the card into the module, first complete the following steps:

---

Step	Action
1	Remove the contents from the box and be sure to keep all original packing materials. The card comes packed in protective antistatic material. You should not remove the card from the material until you are ready to install.
2	Check the shipment for damage and missing parts. In case of damaged or missing parts, contact your delivery agent and your DIGITAL sales representative.
3	Make sure you have the proper Modular Media Interface (MMI) card for your module. ATM modPHY, Fast Ethernet MM-100, and Mod-FDDI cards are not interchangeable.
4	Check the VNswitch 900 Series release notes shipped with the module for important information not included in this manual.

---

## Required Tools

DIGITAL recommends the use of, but does not supply, the following tools to install the cards:

- Phillips-head screwdriver
- Antistatic grounding strap

---

### CAUTION

Static electricity can damage modules and electronic components. DIGITAL recommends using a grounded antistatic wrist strap and a grounded work surface when handling any modules.

---

---

## Removing the Slot Cover

To remove the slot cover from the module (Figure 2-1), complete the following steps:

---

Step	Action
1	Use a Phillips-head screwdriver to loosen the two screws that hold the slot cover in place.
2	Save the screws and slot cover for future use.

---

**Figure 2-1: Removing the Slot Cover**

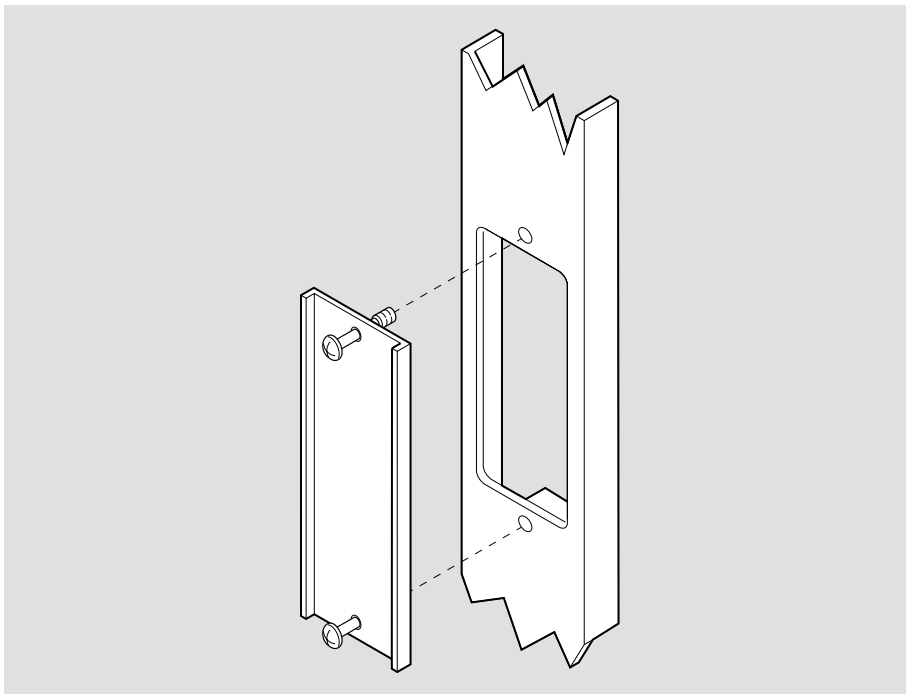

LKG-09986-96F

---

## Installing the Card

To install a card into the module (Figure 2-2), complete the following steps:

---

Step	Action
1	Attach one end of an antistatic wrist strap to your wrist and the other end to the chassis ground. <b>CAUTION:</b> Static electricity can damage modules and electronic components. DIGITAL recommends using a grounded antistatic wrist strap and a grounded work surface when handling any modules.
2	Hold the card by the edges of the bezel so that it is parallel with the slot opening.
3	Insert the card into the slot opening and slide the card along the card guides until the bezel is flush with the module. <u>Note:</u> To prevent the screws from interfering with the card insertion, make sure that the captive screws on the bezel are partially threaded into the bezel threads.
4	Firmly fasten the card to the module with the two captive screws.

---

**Figure 2-2: Installing the Card**

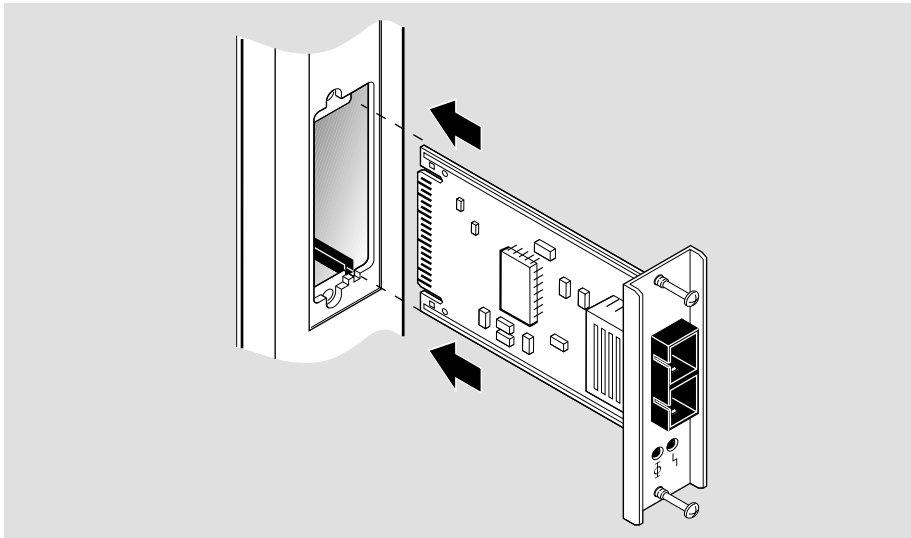

NPB-0904-97F

Depending on the type of MMI card you are installing into the module, differences exist in the way cables are attached and removed.

For cable connection information:

<b>For this card...</b>	<b>Refer to this manual...</b>
MM-100s	<i>100 Mb/s Fast Ethernet Modular Media Interface Cards Installation</i>
modPHYs	<i>ATM Modular PHY Cards Installation</i>

## Removing the Card

To remove a card from the module (Figure 2-3), complete the following steps:

---

Step	Action
1	Attach one end of an antistatic wrist strap to your wrist and the other end to the chassis ground. <b>CAUTION:</b> Static electricity can damage modules and electronic components. DIGITAL recommends using a grounded antistatic wrist strap and a grounded work surface when handling any modules.
2	Disconnect all cables from the card. Refer to the card's documentation for cable removal information.
3	Use a Phillips-head screwdriver to loosen the two captive screws that hold the card in place.
4	Grasp the captive screws and disconnect the card from the host module by pulling on the screws.
5	Gently slide the card out of the slot.
6	Replace the dust caps on the card, if necessary.
7	Place the card into a static-proof bag.
8	If the slot is to be unused, reinstall the slot cover.

---

Removing the Card

Figure 2-3: Removing the Card

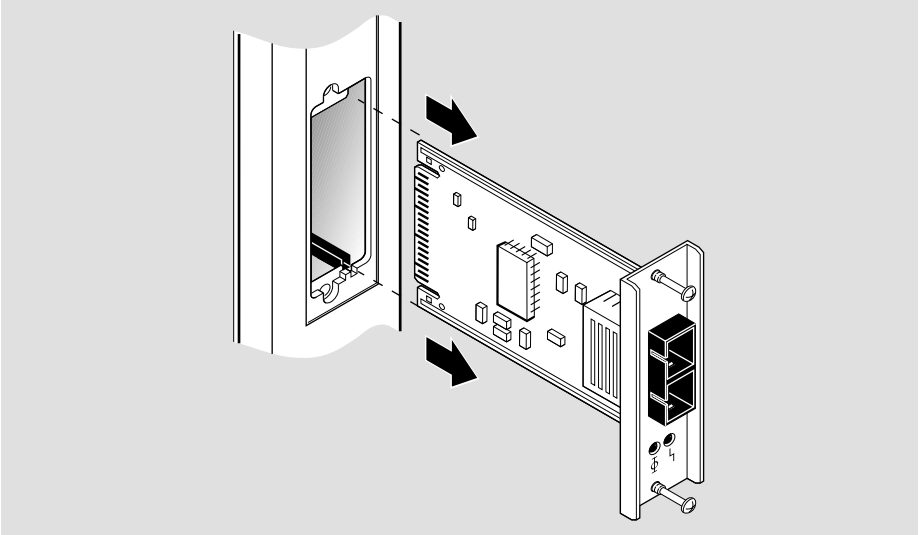

NPB-0905-97F





## Chapter 3

---

# Installing the DIGITAL VNswitch 900XA

---

## Overview

### Introduction

This chapter describes the front and back panel components of the DIGITAL VNswitch 900XA module and provides instructions for installing the module into a DIGITAL MultiSwitch 900 (formerly DEChub 900 MultiSwitch).

To install a module in a DEChub ONE or DEChub ONE-MX docking station, refer to the *DEChub ONE Installation* manual or the *DEChub ONE-MX Installation* manual.

### In This Chapter

Topic	Page
Module Components	3-2
How to Install the Module	3-8

## Module Components

### Introduction

This section describes the front and back panel components of the VNswitch 900XA.

Table 3-1 describes the front panel components, including the icons, that are on the module illustrated in Figure 3-1.

Table 3-2 describes the back panel components, illustrated in Figure 3-2.







For more information about the module's LEDs, refer to Appendix A.

For detailed information on the LEDs associated with the cards, refer to either the *100 Mb/s Fast Ethernet Modular Media Interface Cards Installation* manual or the *ATM Modular PHY Cards Installation* manual.

## Front Panel Components

Table 3-1 describes the front panel components that are illustrated in Figure 3-1.

**Table 3-1: Front Panel LEDs and Connectors**

Item	Icon	Name	Description
1		Power LED	Lights when the module has power.
2		Module OK LED	Lights when the module passes self-test.
3		VNbus Status LED	Shows if the module is properly attached to a VNbus backplane. <sup>1</sup>
4		VNbus Activity LED	Indicates network traffic. <sup>1</sup>
5		Load/Dump/Management (LDM) Port Status LED	Indicates the link status of the Load/Dump/Management port.
6		LDM Activity LED	Indicates when the LDM port is transmitting or receiving packets.
7		LDM Port	Dedicated 10BaseT Ethernet port. Supports loads and upline dumps of an operational image. This port is wired as a straight-through connector.

*(continued on next page)*

<sup>1</sup> The VNbus Status and Activity LEDs have different indications during a load state. Refer to the VNswitch 900 Series Modules release notes for current descriptions.

## Module Components





Item	Icon	Name	Description
8		Reset/Dump Button	Used to either reset the module or perform an upline dump of the operational image, followed by a reset. If this button is depressed as operational code initializes, the module will reset to current settings.  If the module is in operation mode, hold the button for 5 seconds. Use a non-conductive device to press the button.
9		Address Label	Contains the lowest of 256 consecutive Media Access Control (MAC) addresses that corresponds to port 1.
10		MM-100 Port Status LEDs	Show the status of the MM-100 cards. Indicates whether the ports are enabled or disabled and receiving a valid link.
		MM-100 Port Activity LEDs	Indicates network traffic level.
11		Fast Ethernet MM-100 card slots	Supports physical interfaces that can provide an MII interface to the MAC. The card has a dual pair of color LEDs, FRU and PHY LEDs, that indicate state.
12		ATM Port Status LED	Shows the status of the ATM card. Indicates whether the port is enabled or disabled and receiving a valid link.
		ATM Port Activity LED	Indicates network traffic level.
13		ATM modPHY card slot	Supports a variety of ATM modPHYs. For supported options, check the latest release notes.

Figure 3-1: Front Panel LEDs and Connectors



NPB-0822-97F

## Module Components

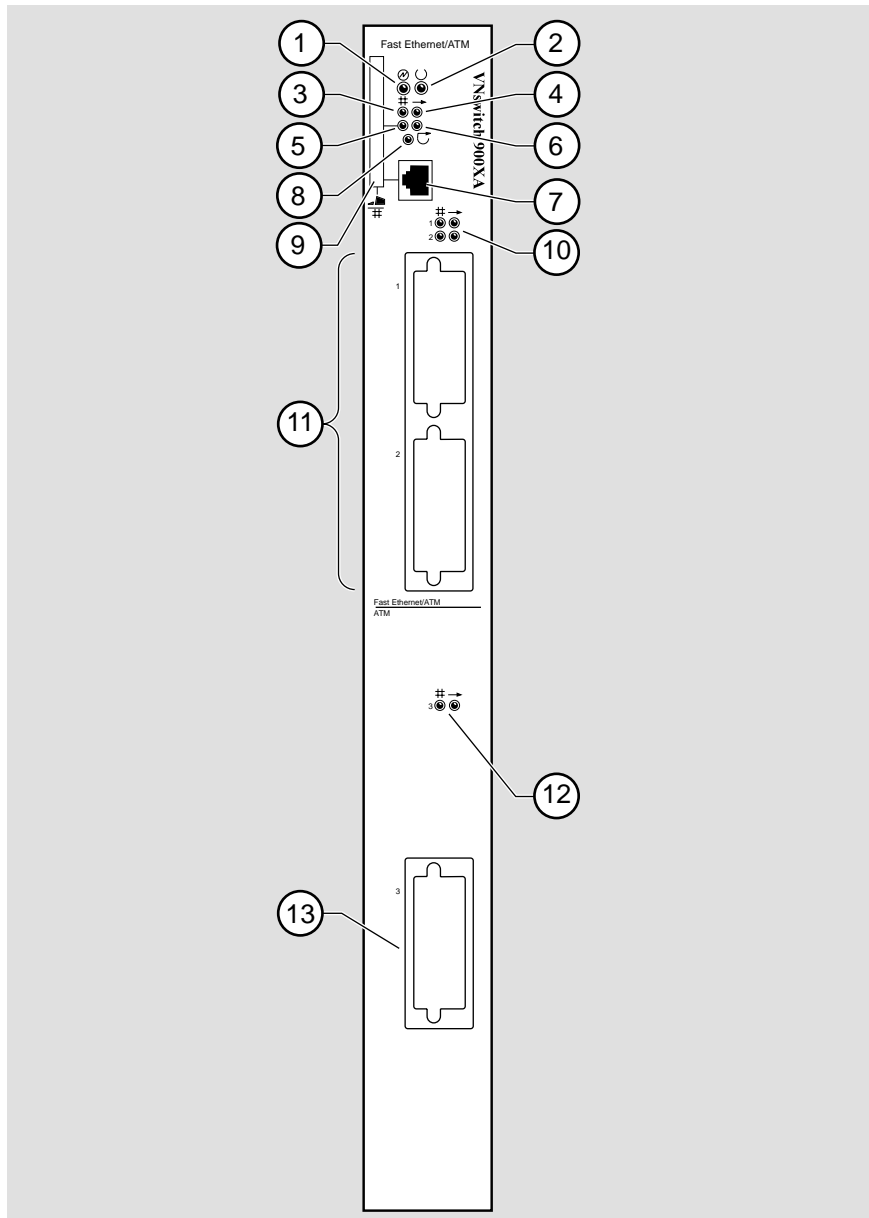
### Back Panel Components

Table 3-2 describes the back panel components that are illustrated in Figure 3-2.

**Table 3-2: Back Panel Components**

Item	Name	Description
1	Locking tab	Locks the module into a MultiSwitch 900 backplane or into a DEChub ONE docking station. Contains the hot-swap switch lever.
2	48-pin connector	Provides network and power connections to the module when the module is installed in a MultiSwitch 900 chassis or DEChub ONE docking station.
3	Grounding bolt	Provides a chassis grounding connection between the module and the MultiSwitch 900 or the DEChub ONE docking station.
4	Manufacturing label	Lists the module's part number, serial number, revision level, and power requirements.
5	160-pin connector	Provides network and power connections to the module when the module is installed into a MultiSwitch 900 or a DEChub ONE docking station.
6	Mounting tab	Secures the module when it is installed into a MultiSwitch 900 or a DEChub ONE docking station.
7	Grounding fingers	Provide additional chassis grounding between the module and a MultiSwitch 900 or a DEChub ONE docking station.

Figure 3-2: Back Panel Layout

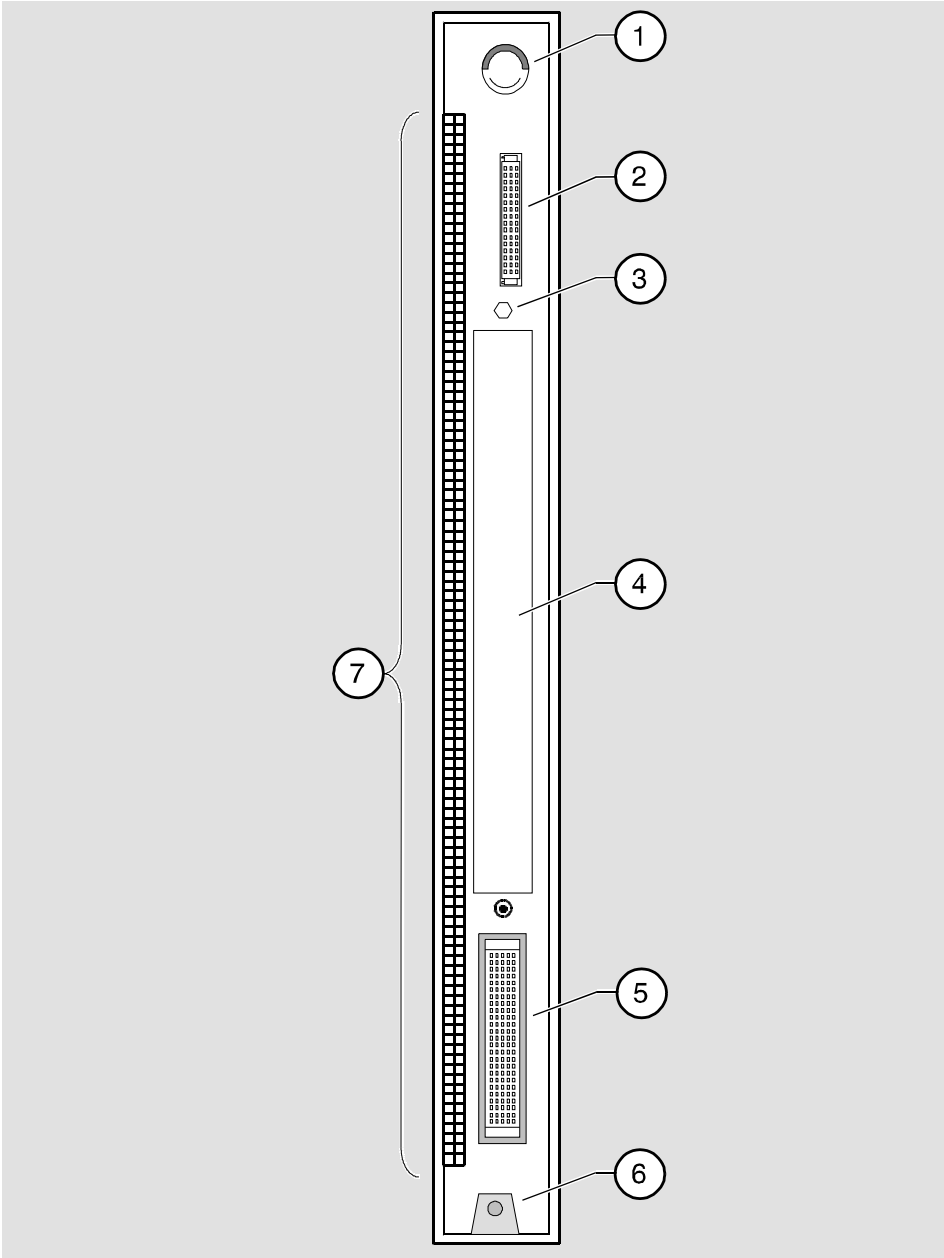

NPG-9723-95F

---

## How to Install the Module

The hot-swap feature allows you to install the module into the DIGITAL MultiSwitch 900 without turning off power. Seating the module initiates the power-up.

To install the module, complete the following tasks.

### Task 1: Compare the Power Ratings

Compare your module's power requirements (1) with the values shown in the Chassis Manager (2) status display (Figure 3-3).

If any of the module's power requirements exceed the values shown in the status display, add another power supply. (See the *DEChub 900 MultiSwitch Owner's Manual*. Note that the title of this manual will change to reflect the product name change from DEChub 900 MultiSwitch to DIGITAL MultiSwitch 900.)

**Figure 3-3: Power Ratings**

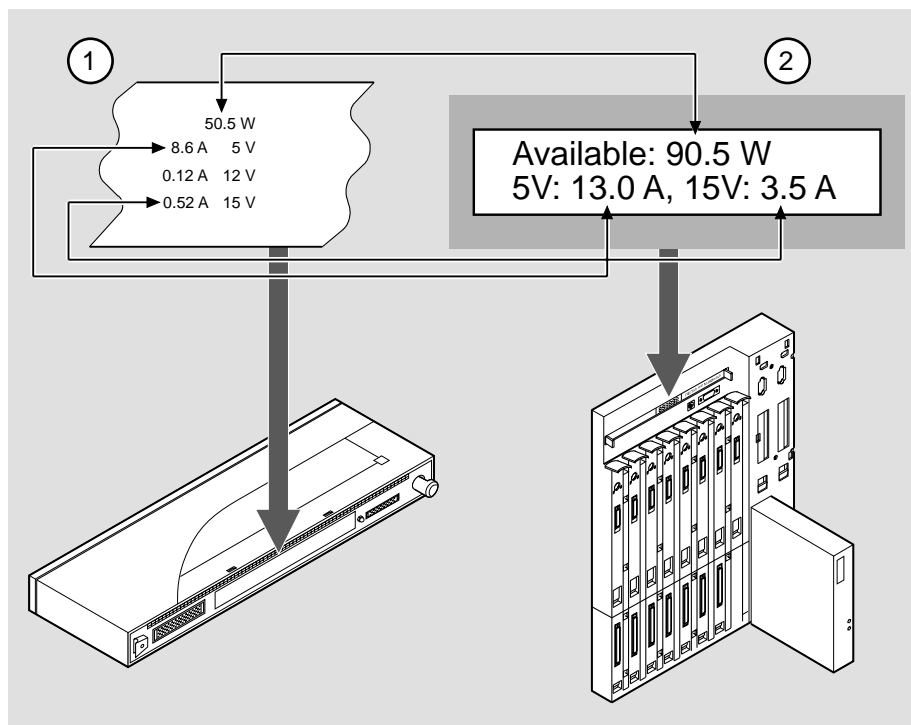

NPB-0823-97F



## Task 2: Seat the Module

To seat the module into a DIGITAL MultiSwitch 900 (Figure 3-4), complete the following steps:

Step	Action
1	Place the module's mounting tab (1) into a mounting slot on the DIGITAL MultiSwitch 900.
2	Pull up the release lever (2) to its unlocked position.
3	Pivot the module on the mounting tab, align the connectors, and firmly push the module onto the backplane connectors.
4	Press down the release lever (3) to ensure that it is locked.

Figure 3-4: Seating the Module

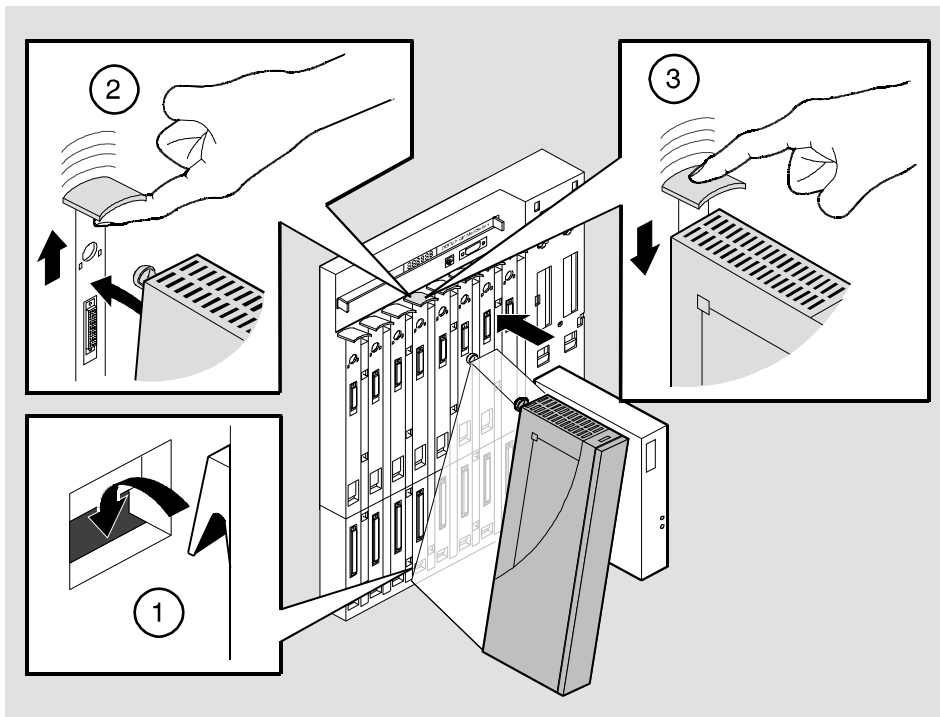

NPG-0004-95F

## How to Install the Module

### Task 3: Verify Initial LED Operation

If...	Then...
This is a new installation	Turn on the power to the MultiSwitch 900.
The module was installed while the MultiSwitch 900 was powered up	Seating the module will initiate the module's power-up sequence. If the LEDs do not operate as described, refer to Appendix A, Problem Solving. To locate the module's LEDs, refer to Figure 3-1.

To verify initial LED operation, check the following stages:

Stage	Description
1	When the module receives power, the Power LED lights and remains lit.
2	The module runs a self-test. <u>Note:</u> The self-test takes approximately 3 minutes to complete.
3	After the module completes self-test, the Module OK LED lights.
4	The Chassis Manager status display identifies the module as the VNSwitch 900XA.

### Task 4: Connect the LDM Port Cable

To perform a remote load/dump, the LDM cable must be connected to the LDM port. The LDM port uses a straight-through, 10BaseT, 8-pin MJ connector.

To connect the LDM port cable to the LDM port (Figure 3-5), complete the following steps:

Step	Action
1	Align the release tab on the cable plug (1) with the keyway on the module's 10BaseT port connector.
2	Insert the plug into the connector (2) ensuring that the release tab snaps into the locked position.

Figure 3-5: LDM Port Cable Connection

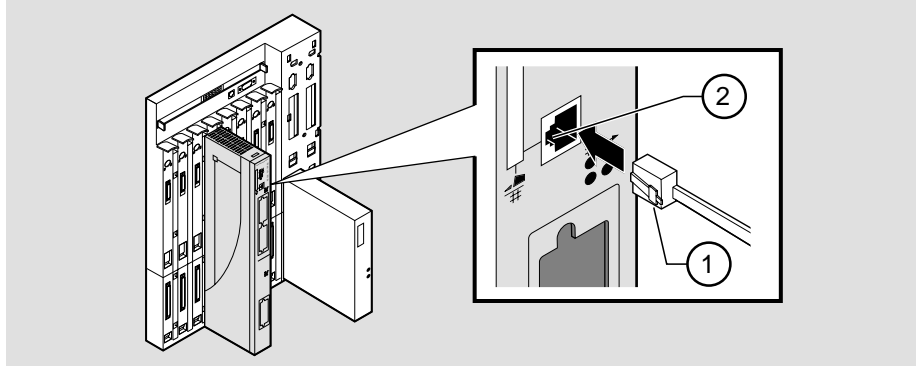

NPB-0824-97F



## Chapter 4

---

# Installing the Setup Port Cable

---

## Overview

### Introduction

The setup port on the DIGITAL MultiSwitch 900 (formerly DEChub 900 MultiSwitch) or the DEChub ONE docking station allows you to access and set DIGITAL VNswitch 900XA parameters. This chapter describes how to access the module from either port and how to set those parameters.

### In This Chapter

Topic	Page
Setup Port Signaling Standards	4-2
Setup Port Device Cabling	4-3
Connecting to the Setup Port	4-4

## Setup Port Signaling Standards

Signals from the MultiSwitch 900 Chassis Manager setup port and from the DEChub ONE docking station setup port conform to the EIA-232D signaling standard at 9600 baud. To the user, the port appears as a data terminal equipment (DTE) device.

The MultiSwitch 900 Chassis Manager setup port is compatible with devices that use the EIA-423 signaling standard.

---

## Setup Port Device Cabling

The setup port (Figure 4-1) on the DIGITAL MultiSwitch 900 or the DEChub ONE docking station can be connected to a setup port device (a terminal or personal computer) by using the following cables and adapters:

---

<b>If the setup port device is...</b>	<b>Use cable...</b>	<b>With adapter...</b>
PC with a 9-pin D-sub communications port	BN24H-xx <sup>1</sup>	H8571-J
Terminal with a 25-pin D-sub connector	BN24H-xx <sup>1</sup>	H8575-A
Terminal with a 6-pin MMJ connector	BN24H-xx <sup>1</sup>	Not required

---

<sup>1</sup> xx indicates cable length in meters

## Connecting to the Setup Port

To connect to the setup port (Figure 4-1), complete the following steps:

Step	Action
1	Ensure that the transmit and receive baud rates on the setup port device are set to 9600 baud.
2	Connect the setup port device to the setup port connector on either the DIGITAL MultiSwitch 900 or the DEChub ONE docking station (Figure 4-1).

The following legend identifies the setup port cabling in Figure 4-1.

Item	Description
1	Out-of-Band Management (OBM) Port
2	Setup Port
3	Setup Port Device



**Figure 4-1: Setup Port Cabling Components**

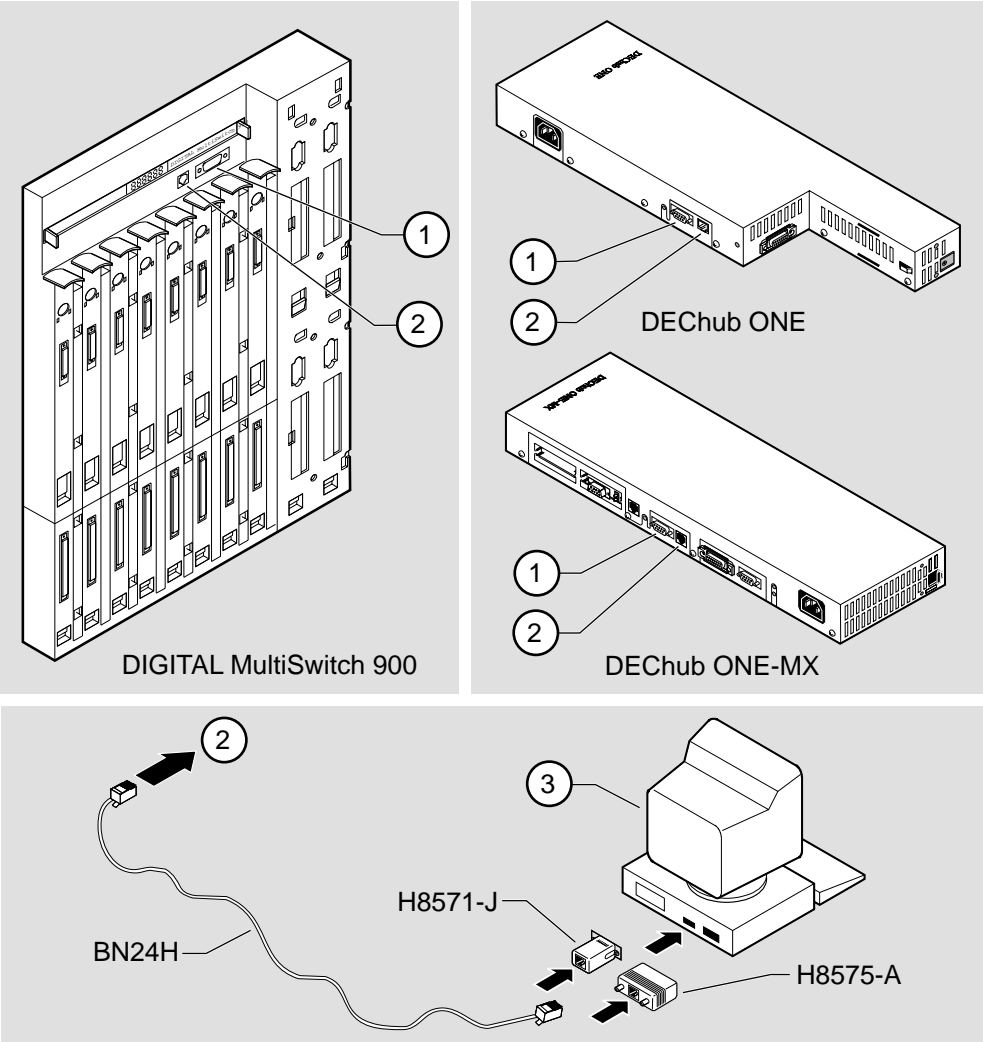

NPG-0020-95F

After all cables are connected, go to one of the following chapters:

To...	Go to...
Configure the module in a DEChub ONE	Chapter 5
Configure the module in a MultiSwitch 900	Chapter 6



## Chapter 5

---

# Configuring the Module in a DEChub ONE

---

## Overview

### Introduction

This chapter describes how to configure your DIGITAL VNswitch 900XA module when it is installed in a DEChub ONE docking station.

For further configuration information, refer to the *VNswitch 900 Series Switch Management*.

### In This Chapter

---

Topic	Page
Assigning an IP Address	5-2
Using Menus to Configure the Module	5-3
[1] Restart with Factory Defaults	5-4
[2] Restart with Current Settings	5-5
[3] Show Current Settings	5-6
[4] Configure IP	5-7
[5] Go to Local Console	5-12
[6] Product-Specific Options	5-13

---

## Assigning an IP Address

After installing the module in a DEChub ONE docking station, connecting the cables, and assigning an IP address, you need to configure the module. Do this using one of the following methods:

- A Telnet session to access the command line interface
- Through the command line interface, which is accessed through a terminal connected to the setup port on the DEChub ONE docking station
- Through clearVISN MultiChassis Manager

The setup port provides menus that allow you to access the VNswitch 900XA. These menus allow you to set up the module for basic connectivity. After setup, you can configure the module's software by using commands. You can access these commands remotely via TCP/IP Telnet, or locally through the setup port on a DEChub ONE.

To perform a Telnet session, you must assign an IP address. To do this, complete the following steps:

---

<b>Step</b>	<b>Action</b>
<b>1</b>	Install the module into a DEChub ONE.
<b>2</b>	Select the IP Configuration option from the menu.
<b>3</b>	Set the in-band IP address.
<b>4</b>	Set the default gateway, if necessary.
<b>5</b>	Return to the VNswitch 900XA INSTALLATION MENU and select [2] Restart with Current Settings.
<b>6</b>	Open a Telnet session into the module from the management station for further configuration.  To access the configuration menus, press Return on the setup port device until the VNswitch 900XA INSTALLATION MENU appears.  For further configuration information, refer to the <i>VNswitch 900 Series Switch Management</i> .

---

---

## Using Menus to Configure the Module

This section describes the options that are available from the VNswitch 900XA INSTALLATION MENU when the module is installed in the DEChub ONE docking station. Depending on the configuration state of the module, some options may vary.

To modify the configuration, select [5] Go To Local Console.

```
VNswitch 900XA
=====
          VNswitch 900XA INSTALLATION MENU
          [1] Restart with Factory Defaults
          [2] Restart with Current Settings
          [3] Show Current Settings
          [4] Configure IP ...
          [5] Go to Local Console
          [6] Product-Specific Options ...
=====
Enter selection:  5 <Return>
```

[1] Restart with Factory Defaults

---

## [1] Restart with Factory Defaults

This option initializes the module's configuration to factory default values by resetting the module's nonvolatile configuration storage parameters and restarting the module. To restart the module without losing the settings, use option [2] Restart with Current Settings.

---

### CAUTION

This action deletes all configured settings and replaces them with factory default values. All configuration settings will be lost.

---

The following example shows the dialog associated with this option:

```
VNswitch 900XA
=====
                        RESTART WITH FACTORY DEFAULTS

* * * * *
      IMPORTANT!   IMPORTANT!   IMPORTANT!
* * * * *
This selection will delete the current configuration
settings and reset the system with the factory default
settings. All configuration settings will be lost.
* * * * *
=====
      Press Y to confirm [N]:  <Return>

      Press Return for Main Menu...
```

---

## [2] Restart with Current Settings

This option resets the module but leaves the module's configured nonvolatile configuration storage parameters at their current values.

---

### NOTE

Allow approximately 1 minute for the module to restart.

---

The following example shows the dialog associated with this option:

```
VNswitch 900XA
=====
                RESTART WITH CURRENT SETTINGS

This selection will reset your system with the current
configuration settings.
=====
Press Y to confirm [N] : <Return>
Press Return for Main Menu...
```

### [3] Show Current Settings

---

## [3] Show Current Settings

This option shows the module's current settings. If the module is being configured for the first time, some fields will be blank.

The following example shows the dialog associated with this option:

```
VNswitch 900XA
=====
VNswitch 900XA, 2 FastEth 100MPBS, 1 ATM , HW=v1.2,RO=v0.4,#525 SW=v1.7
SysUpTime           : 6 days 00:03:18   2 resets
SNMP Read/Write Community : public
Default Gateway:    : Not Configured

Interface      IP Address      Subnet Mask      Other Info
In-Band          16.20.216.91     255.255.255.0     08-00-2B-A6-0E-05
OBM Port         16.20.66.156    255.255.255.0     Speed 9600 bps
=====
Press Return for Main Menu...
```



---

## [4] Configure IP

This option provides you with IP configuration selections.

---

### NOTE

For any of the IP Configuration menu options to take effect, the module needs to be reset. Use [2] Restart with Current Settings from the VNswitch 900XA INSTALLATION MENU. Allow approximately one minute for the module to restart and complete self-test.

---

The following example shows the dialog associated with this option:

```
VNswitch 900XA
=====
                        IP CONFIGURATION
* * * * *
Configuration will not take effect until module is
restarted
* * * * *

    [1] Set SNMP Read/Write Community
    [2] Set In-Band Interface IP Address
    [3] Set Out-of-Band Interface IP Address
    [4] Set Default Gateway
    [5] Return to Main Menu

=====
Enter selection number : [n] <Return>
```

The following pages describe the IP Configuration options:

---

Topic	Page
[1] Set SNMP Read/Write Community	5-8
[2] Set In-Band Interface IP Address	5-9
[3] Set Out-of-Band Interface IP Address	5-10
[4] Set Default Gateway	5-11

---

[4] Configure IP

### [1] Set SNMP Read/Write Community

This option prompts you to enter the module's read/write community name. The community name can be used for read/write access control. The read/write community name is case sensitive. The default is `public`.

The following example shows the dialog associated with this option:

```
VNswitch 900XA
=====
                SET SNMP READ/WRITE COMMUNITY

Format:  The format for a community name is a string,
         consisting of 4 to 31 printable ASCII characters, that
         describes the relationship between an SNMP agent and
         one or more SNMP managers. The string defines the
         authentication mechanism that is employed to validate
         the use of the community by the sending SNMP entity.
=====

Enter the community string [public] : <Return>

SNMP Read/Write community string set.

Press Return for IP Configuration Menu...
```

## [2] Set In-Band Interface IP Address

This option prompts you to change or enter the module's in-band IP address, subnet mask, and default gateway for the in-band interface. If an IP address was previously configured, the screen displays an in-band IP address. The factory default setting is no in-band address.

You do not need to configure the module with a subnet mask for SNMP communications with management stations located on the same subnet as the module.

The following example shows the dialog associated with this option:

```

VNswitch 900XA
=====
                IN-BAND INTERFACE IP ADDRESS CONFIGURATION

Format: The standard 4 octet dotted decimal notation in which
each octet of the address is represented as a decimal
value, separated by a '.' character.

                example: 16.20.40.156

To delete the IP address, enter 0 in the appropriate
address field.

Interface      IP Address      Subnet Mask      Other Info
-----
In-Band        16.20.216.91    255.255.255.0    08-00-2B-A3-CD-08
OBM Port       16.20.66.156    255.255.255.0    Speed 9600 bps
=====

Enter the IP address [16.20.126.24] : 16.20.54.156 <Return>
Enter the Subnet Mask [255.0.0.0] : 255.255.0 0 : <Return>

                Press Return for IP Configuration Menu...
    
```

#### [4] Configure IP

### [3] Set Out-of-Band Interface IP Address

This option prompts you to change or enter the IP address and subnet mask for the out-of-band interface. The module does not need to be configured with a subnet mask for SNMP communications when management stations are on the same subnet as the module.

The format for these values is the standard 4-octet dotted decimal notation, where each octet of the address is represented as a decimal value, separated by a decimal point (.).

If the module is in a DEChub ONE, the OBM feature allows you to manage your module through the OBM port located on the DEChub ONE. To enable out-of-band management, you need to assign an OBM IP address.

The following example shows the dialog associated with this option:

```
VNswitch 900XA
=====
                OUT-OF-BAND INTERFACE IP ADDRESS CONFIGURATION

Format: The standard 4 octet dotted decimal notation in which
        each octet of the address is represented as a decimal
        value, separated by a '.' character.

                example: 16.20.40.156

        To delete the IP address, enter 0 in the appropriate
        address field.

=====
Interface      IP Address      Subnet Mask      Other Info
-----
In-band        16.20.216.91    255.255.255.0    08-00-2B-A3-CD-08
OBM Port       16.20.66.156    255.255.255.0    Speed 9600 bps
=====
Enter the IP address [16.20.66.156] : 16.20.54.155 <Return>
Enter the Subnet Mask [255.255.255.0] : 255.255.192.0 <Return>

Press Return for IP Configuration Menu...
```

## [4] Set Default Gateway

This option sets the default gateway, if necessary, for the in-band interface. This is the address of a router that the module uses when communicating with a remote host. The default gateway address must be an address in the same subnet as your in-band address.

The following example shows the dialog associated with this option:

```
VNswitch 900XA
=====
      SET IN-BAND INTERFACE DEFAULT GATEWAY ADDRESS

Format: The standard 4 octet dotted decimal notation in which
each octet of the address is represented as a decimal
value, separated by a '.' character.

      example: 16.20.40.156

      To delete the address, enter 0 in the appropriate
      address field.

=====

Default Gateway [ ] : 16.126.16.254 <Return>

Default Gateway Address Set.

      Press Return for IP Configuration Menu...
```

[5] Go to Local Console

---

## [5] Go to Local Console

To perform additional configurations on the module, select [5] Go To Local Console from the VNswitch 900XA INSTALLATION MENU.

The system will display the copyright statements and the following prompt:

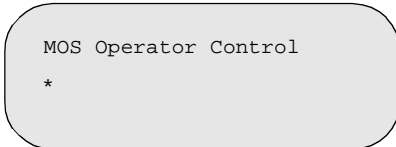
A screenshot of a terminal window showing the prompt "MOS Operator Control" followed by an asterisk "\*" on the next line. The text is displayed in a monospaced font within a light gray rounded rectangular box.

```
MOS Operator Control
*
```

From the \* prompt, you can perform additional configuration. Refer to *VNswitch 900 Series Switch Management* for further configuration information.

---

## [6] Product-Specific Options

To view or clear the module's error log entries, select [6] Product-Specific Options... from the VNswitch 900XA INSTALLATION MENU:

```
VNswitch 900XA
=====
VNswitch 900 Product Specific Options

    [1] Clear CRASH and DIAGNOSTIC Error Logs
    [2] List CRASH and DIAGNOSTIC Error Logs
    [3] Return to Main Menu

=====

Enter selection:  n <Return>
```

If you select [2] List CRASH and DIAGNOSTIC Error Logs, the screen shows the list of messages recorded to both logs. Select option [1] to clear the information in the logs. Select option [3] to return to the VNswitch 900XA INSTALLATION MENU.





## Chapter 6

---

# Configuring the Module in a DIGITAL MultiSwitch 900

---

## Overview

### Introduction

This chapter describes how to configure your DIGITAL VNswitch 900XA when it is installed in a DIGITAL MultiSwitch 900 (formerly DEChub 900 MultiSwitch).

For further configuration information, refer to *VNswitch 900 Series Switch Management*.

### In This Chapter

---

Topic	Page
Assigning an IP Address	6-2
DEChub 900 MultiSwitch INSTALLATION MENU	6-3
[9] Start Redirect Mode	6-4
Using Menus to Configure the Module	6-5
[1] Restart with Factory Defaults	6-6
[2] Restart with Current Settings	6-7
[3] Show Current Settings	6-8
[4] Configure IP	6-9
[5] Go to Local Console	6-14
[6] Product-Specific Options (VNswitch 900XA)	6-15
[10] Product-Specific Options (DIGITAL MultiSwitch 900)	6-16

---

## Assigning an IP Address

After installing the module in a DIGITAL MultiSwitch 900, connecting the cables, and assigning an IP address, you need to configure the module. Do this using one of the following methods:

- A Telnet session to access the command line interface
- Through the command line interface, which is accessed through a terminal connected to the setup port on the MultiSwitch 900
- Through clearVISN MultiChassis Manager

To perform a Telnet session, you must assign an IP address. To do this, complete the following steps:

---

Step	Action
1	Install the module into a slot on the DIGITAL MultiSwitch 900.
2	Redirect the DIGITAL MultiSwitch 900 Chassis Manager setup port to the VNswitch 900XA slot.
3	Select the IP Configuration option from the menu.
4	Set the in-band IP address.
5	Set the default gateway, if necessary.
6	Return to the VNswitch 900XA INSTALLATION MENU and select [2] Restart with Current Settings.
7	Open a Telnet session into the module from the management station for further configuration. The system displays copyright statements and the following prompt:

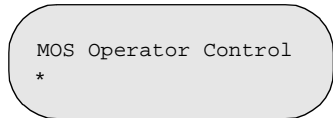
A screenshot of a terminal window showing the prompt "MOS Operator Control" followed by an asterisk "\*" on the next line. The text is displayed in a monospaced font within a rounded rectangular border.

```
MOS Operator Control
*
```

After the system prompt (\*) appears, refer to *VNswitch 900 Series Switch Management* for further configuration information.

---

---

## DEChub 900 MultiSwitch INSTALLATION MENU

The following example shows the DEChub 900 MultiSwitch INSTALLATION MENU.

---

### NOTE

This menu name will change to DIGITAL MultiSwitch 900 in a future version of the Chassis (formerly Hub) Manager firmware to reflect the product name change.

---

To access the module's installation menu, you must choose option [9] Start Redirect Mode.

```
DEChub 900 MultiSwitch
=====
DEChub 900 MultiSwitch INSTALLATION MENU

[1] Restart with Factory Defaults
[2] Restart with Current Settings
[3] Show Current Settings
[4] Configure IP...
[5] Dump Error Log
[6] Downline Upgrade
[7] Configure Out-of-Band Port...
[8] Start Event Display Mode
[9] Start Redirect Mode
[10] Product-Specific Options...

=====
Enter selection number: 9 <Return>
Press Return for Main Menu...
```

## [9] Start Redirect Mode

---

### [9] Start Redirect Mode

The `Start Redirect Mode` option redirects the DIGITAL MultiSwitch 900 Chassis Manager setup port to the setup port of any network module (such as the VNswitch 900XA) that is installed into the MultiSwitch 900. This option allows you to configure or obtain status of an installed network module by accessing the specified network module's installation menu.

After you choose the `Start Redirect Mode` option from the `DEChub 900 MultiSwitch INSTALLATION MENU`, the screen prompts you for a slot number, as shown in the following example. After you enter the number of the slot in which the VNswitch 900XA is installed, the console is redirected to this slot.

---

#### NOTE

The slot number may change to reflect the slot number in which your module is installed.

---

The following example shows you how to redirect the console to a specific slot:

```
Enter the slot number for redirection (1-8): 3 <Return>
Console redirected to 3: VNswitch 900XA
Attempting connection [Ctrl/C to Abort]...
Connection successful!
```

If the redirection is successful, after you press `Return`, the `VNswitch 900XA INSTALLATION MENU` appears on your screen. If redirection is not successful, for example, you entered a number for an empty slot, you can press `Return` to start again at the `DEChub 900 MultiSwitch INSTALLATION MENU`.

---

## Using Menus to Configure the Module

The following screen shows the options available from the VNswitch 900XA INSTALLATION MENU when the module is operating in a MultiSwitch 900 configuration. Depending on the configuration state of the module, some options may not appear.

Note that when your module is installed in the MultiSwitch 900, the slot number where the module is installed appears at the top of the menu.

```
VNswitch 900XA - slot 3
=====
          VNswitch 900XA INSTALLATION MENU

          [1] Restart with Factory Defaults
          [2] Restart with Current Settings
          [3] Show Current Settings
          [4] Configure IP
          [5] Go to Local Console
          [6] Product-Specific Options...

          [Ctrl/C] Return to Hub Manager Installation Menu
          =====

          Enter selection:  n  <Return>
```

[1] Restart with Factory Defaults

---

## [1] Restart with Factory Defaults

This option initializes the module's configuration to factory default values by resetting the module's nonvolatile configuration storage parameters and restarting the module. To restart the module without losing the settings, use option [2] Restart with Current Settings.

---

### CAUTION

This action deletes all configured settings and replaces them with factory default values. All configuration settings will be lost.

---

The following example shows the dialog associated with this option:

```
VNswitch 900XA - slot 3
=====
                        RESTART WITH FACTORY DEFAULTS

* * * * *
      IMPORTANT!   IMPORTANT!   IMPORTANT!
* * * * *

This selection will delete the current configuration
settings and reset the system with the factory default
settings. All configuration settings will be lost.
* * * * *

=====
Press Y to confirm [N]:  <Return>

Press Return for Main Menu...
```

---

## [2] Restart with Current Settings

This option resets the module but leaves the module's configured nonvolatile configuration storage parameters at their current values.

---

### NOTE

Allow approximately 1 minute for the module to restart.

---

The following example shows the dialog associated with this option:

```
VNswitch 900XA - slot 3
=====
                        RESTART WITH CURRENT SETTINGS

This selection will reset your system with the current
configuration settings.
=====
Press Y to confirm [N]: <Return>
Press Return for Main Menu...
```

[3] Show Current Settings

---

## [3] Show Current Settings

This option shows the module's current settings. If the module is being configured for the first time, some fields will be blank. The read/write community name is case sensitive.

The following example shows the display associated with this option:

```
VNswitch 900XA - slot 3
=====
VNswitch 900XA, 2 FastEth 100MBPS 1 ATM, HW=v1.2,RO=v0.4,#525 SW=v1.7
SysUpTime           : 6 days 00:03:18   2 resets
SNMP Read/Write Community : public
Default Gateway:    : Not Configured

Interface      IP Address      Subnet Mask      Other Info
In-Band          16.20.216.91     255.255.255.0     08-00-2B-A6-0E-05
OBM Port         16.20.66.156    255.255.255.0     Speed 9600 bps
=====

Press Return for Main Menu...
```



---

## [4] Configure IP

This option provides you with IP configuration selections.

---

### NOTE

For any of the IP Configuration menu options to take effect, the module needs to be reset. Use [2] Restart with Current Settings from the VNswitch 900XA INSTALLATION MENU. Allow approximately 1 minute for the module to restart and complete self-test.

---

The following example shows the dialog associated with this option:

```

VNswitch 900XA
=====
                        IP CONFIGURATION
* * * * *
Configuration will not take effect until module is
restarted
* * * * *

    [1] Set SNMP Read/Write Community
    [2] Set In-Band Interface IP Address
    [3] Set Out-of-Band Interface IP Address
    [4] Set Default Gateway
    [5] Return to Main Menu

=====
Enter selection number: [n] <Return>

```

The following pages describe the IP Configuration options:

Topic	Page
[1] Set SNMP Read/Write Community	6-10
[2] Set In-Band Interface IP Address	6-11
[3] Set Out-of-Band Interface IP Address	6-12
[4] Set Default Gateway	6-13

---

#### [4] Configure IP

### [1] Set SNMP Read/Write Community

This option prompts you to enter the module's read/write community name. The community name can be used for read/write access control. The read/write community name is case sensitive. The default is `public`.

The following example shows the dialog associated with this option:

```
VNswitch 900XA - slot 3
=====
                        SET SMNP READ/WRITE COMMUNITY

Format:  The format for a community name is a string,
         consisting of 4 to 31 printable ASCII characters, that
         describes the relationship between an SNMP agent and
         one or more SNMP managers. The string defines the
         authentication mechanism that is employed to validate
         the use of the community by the sending SNMP entity.
=====

Enter the community string [public]: <Return>

SNMP Read/Write community string set.

Press Return for IP Configuration Menu...
```

## [2] Set In-Band Interface IP Address

This option prompts you to change or enter the module's in-band IP address, subnet mask, and default gateway for the in-band interface. If an IP address was previously configured, the screen displays an in-band IP address. The factory default setting is no in-band address.

You do not need to configure the module with a subnet mask for SNMP communications with management stations located on the same subnet as the module.

The following example shows the dialog associated with this option:

```

VNswitch 900XA - slot 3
=====
                IN-BAND INTERFACE IP ADDRESS CONFIGURATION

Format: The standard 4 octet dotted decimal notation in which
        each octet of the address is represented as a decimal
        value, separated by a '.' character.

        example: 16.20.40.156

        To delete the IP address, enter 0 in the appropriate
        address field.

Interface      IP Address      Subnet Mask      Other Info
-----
In-Band        16.20.216.91    255.255.255.0    08-00-2B-A3-CD-08
OBM Port       16.20.66.156    255.255.255.0    Speed 9600 bps
=====

Enter the IP address [16.20.126.24] : 16.20.54.156 <Return>
Enter the Subnet Mask [255.0.0.0] : 255.255.255.0 <Return>

        Press Return for IP Configuration Menu...
    
```

#### [4] Configure IP

### [3] Set Out-of-Band Interface IP Address

This option prompts you to change or enter the IP address and subnet mask for the out-of-band interface. The module does not need to be configured with a subnet mask for SNMP communications when management stations are on the same subnet as the module.

The format for these values is the standard 4-octet dotted decimal notation, where each octet of the address is represented as a decimal value, separated by a decimal point (.).

If the module is in a MultiSwitch 900, the OBM feature allows you to manage your module through the OBM port located on the MultiSwitch 900. To enable out-of-band management, you need to assign an OBM IP address.

The following example shows the dialog associated with this option:

```
VNswitch 900XA - slot 3
=====
OUT-OF-BAND INTERFACE IP ADDRESS CONFIGURATION

Format: The standard 4 octet dotted decimal notation in which
each octet of the address is represented as a decimal
value, separated by a '.' character.

example: 16.20.40.156

To delete the IP address, enter 0 in the appropriate
address field.

=====
Interface      IP Address      Subnet Mask      Other Info
-----
In-band        16.20.216.91    255.255.255.0    08-00-2B-A3-CD-08
OBM Port       16.20.66.156    255.255.255.0    Speed 9600 bps
=====
Enter the IP address [16.20.66.156] : 16.20.54.155 <Return>
Enter the Subnet Mask [255.255.255.0] : 255.255.192.0 <Return>

Press Return for IP Configuration Menu...
```

## [4] Set Default Gateway

This option sets the default gateway, if necessary. This is the address the module uses when communicating with a remote host. The default gateway address must be in the same subnet as your in-band address.

The following example shows the dialog associated with this option:

```
VNswitch 900XA - slot 3
=====
      SET IN-BAND INTERFACE DEFAULT GATEWAY ADDRESS

Format: The standard 4 octet dotted decimal notation in which
each octet of the address is represented as a decimal
value, separated by a '.' character.

      example: 16.20.40.156

      To delete the address, enter 0 in the appropriate
      address field.

=====

Default Gateway [] : 16.126.16.254 <Return>

Default Gateway Address Set.

      Press Return for IP Configuration Menu...
```

[5] Go to Local Console

---

## [5] Go to Local Console

To perform additional configurations on the module, select [5] Go To Local Console from the VNswitch 900XA INSTALLATION MENU.

The system will display the copyright statements and the following prompt:

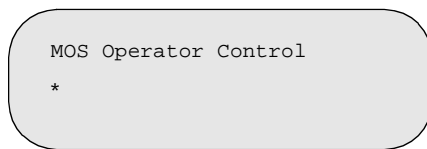

```
MOS Operator Control
*
```

From the \* prompt, you can perform additional configuration. Refer to the *VNswitch 900 Series Switch Management* for further configuration information.

To return to the DEChub 900 MultiSwitch INSTALLATION MENU from the \* prompt, press Ctrl/C.

## [6] Product-Specific Options (VNswitch 900XA)

---

### [6] Product-Specific Options (VNswitch 900XA)

To view or clear the module's error log entries, select [6] Product-Specific Options... from the VNswitch 900XA INSTALLATION MENU:

```
VNswitch 900XA- slot 3
=====
VNswitch 900 Product Specific Options

    [1] Clear CRASH and DIAGNOSTIC Error Logs
    [2] List CRASH and DIAGNOSTIC Error Logs
    [3] Return to Main Menu

=====

Enter selection:  n <Return>
```

If you select [2] List CRASH and DIAGNOSTIC Error Logs, the screen shows the list of messages recorded to both logs. Select option [1] to clear the information in the logs. Select option [3] to return to the VNswitch 900XA INSTALLATION MENU.

[10] Product-Specific Options (DIGITAL MultiSwitch 900)

---

## [10] Product-Specific Options (DIGITAL MultiSwitch 900)

This option provides product-specific selections when you are using a DIGITAL MultiSwitch 900. When selected, the option allows you to enable and disable the automatic VNbus connection. Please note that this menu name will change to DIGITAL MultiSwitch 900 in a future revision of the Chassis Manager firmware to reflect the product name change.

```
DEChub 900 MultiSwitch
=====
                PRODUCT-SPECIFIC OPTIONS
    [1] Enable/Disable Automatic VNbus Connection
    [2] Return to Main Menu

    Enter selection:
```

If you select the option [1] Enable/Disable Automatic VNbus Connection the following menu appears:

```
DEChub 900 MultiSwitch
=====
                ENABLE / DISABLE AUTOMATIC VNbus CONNECTION

    Enabling Automatic VNbus Connection means that certain backplane
    channels will be reserved for a VNbus. The channels will be
    reserved as soon as this feature is Enabled, and will remain
    reserved until this feature is Disabled. When a VNswitch module
    is inserted into the hub, it will connect automatically to the
    VNbus. The Enable function will return an error if backplane channels
    cannot be reserved due to existing conditions.

    Disabling Automatic VNbus Connection means that no backplane channels
    will be reserved for a VNbus. Inserting VNswitch modules will not
    create connections to a VNbus. If any VNswitch modules are
    connected to a VNbus when the Disable mode is selected, the VNbus
    will remain until the last VNswitch module is removed from the hub.

    =====
    Automatic VNbus connection is Enable. Would you like to Disable it? [N]

    Press Return for Product-Specific Options Menu...
```



# Chapter 7

---

## Removing the Module

---

### Overview

#### Introduction

This chapter describes how to remove the DIGITAL VNswitch 900XA module from a DIGITAL MultiSwitch 900 (formerly DEChub 900 MultiSwitch).

To remove the VNswitch 900XA module from a DEChub ONE or a DEChub ONE-MX docking station, refer to the *DEChub ONE Installation* manual or the *DEChub ONE-MX Installation* manual.

#### In This Chapter

Topic	Page
Removing the Cables	7-2
Unseating the Module	7-3

---

---

## Removing the Cables

Before the module is unseated, the load/dump/management (LDM) cable must be removed from the module. To remove the cable (Figure 7-1), complete the following steps:

---

Step	Action
1	Push in the release tab (1) on the side of the connector.
2	Pull out the (2) cable.

---

**Figure 7-1: Removing the LDM Port Cable**

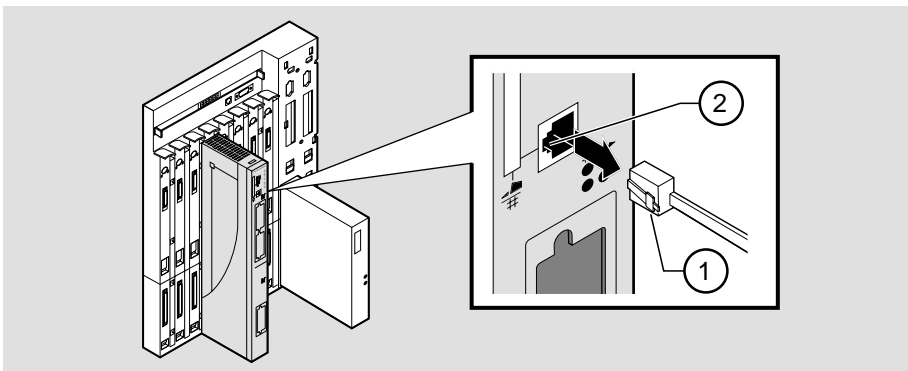

NPB-0825-97F

Depending on the type of Modular Media Interface (MMI) card and its connections, differences exist in the way cables are removed.

For cable removal information:

---

For this card ...	Refer to this manual...
MM-100s	<i>100 Mb/s Fast Ethernet Modular Media Interface Cards Installation</i>
modPHYs	<i>ATM Modular PHY Cards Installation</i>

---

## Unseating the Module

To unseat the module from the DIGITAL MultiSwitch 900 (Figure 7-2), complete the following steps:

Step	Action
1	Lift the release lever (1) at the top of the DIGITAL MultiSwitch 900 slot.
2	While holding up the release lever (2), pivot the module back on its bottom mounting tab.
3	Lift the module (3) from the backplane.

Figure 7-2: Unseating the Module

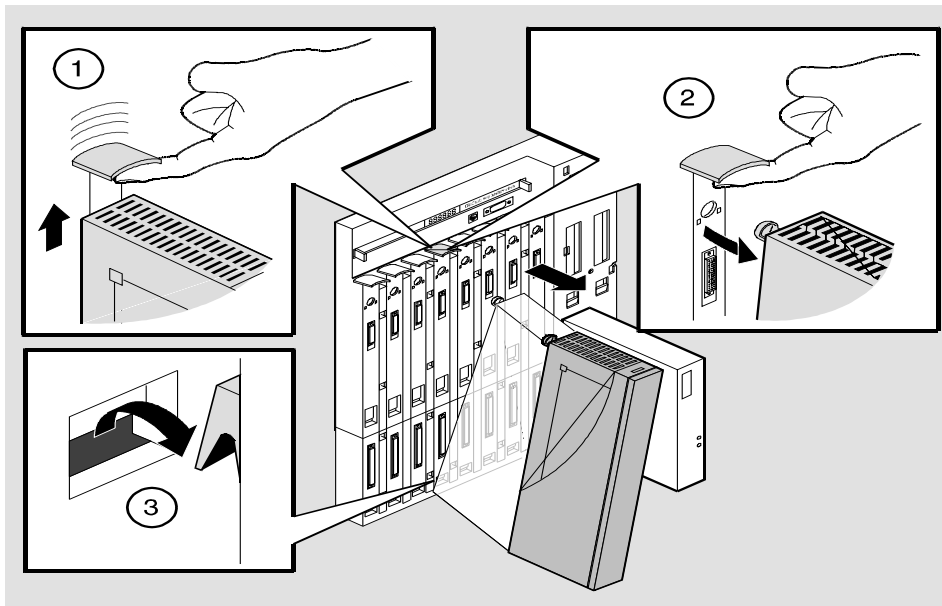

NPG-0008-95F



# Appendix A

---

## Problem Solving

---

### Overview

#### Introduction

This appendix describes how to diagnose and solve problems with the module using the light-emitting diode (LED) displays.

For detailed information on the LEDs associated with a Modular Media Interface (MMI) card, refer to the appropriate manual.

---

<b>For this card...</b>	<b>Refer to this manual...</b>
MM-100s	<i>100 Mb/s Fast Ethernet Modular Media Interface Cards Installation</i>
modPHYs	<i>ATM Modular PHY Cards Installation</i>

---

#### In This Appendix

---

<b>Topic</b>	<b>Page</b>
Normal Power-Up	A-2
LED Descriptions	A-3
Problem Solving Using LEDs	A-5

---

## Normal Power-Up

---

### Normal Power-Up

When the module's power is initially turned on, the following events occur:

Event	Description
1	The module's Power LED lights as soon as power is applied to the unit.
2	The module initiates its built-in self-test. Flashing Port State LEDs and Port Activity LEDs indicate that the module is running various subroutines as part of the self-test.
3	After the successful completion of self-test (within 3 minutes after power is applied), the Module OK LED becomes lit.
4	The remaining LEDs now indicate their operational status.

Refer to Table A-1 for a list of states that are possible for each of the module's LEDs.

For detailed information on the cards LEDs, refer to either the *100 Mb/s Fast Ethernet Modular Media Cards Interface Installation* manual or the *ATM Modular PHY Cards Installation* manual.





## LED Descriptions

The module's LEDs provide dynamic indications of the module's status. The LEDs can be in various states (on, off, or flashing), and can change color (green or yellow) depending on the operational status of the module or the level of activity on the network.

For detailed information on cards LEDs, refer to either the *100 Mb/s Fast Ethernet Modular Media Cards Interface Installation* manual or the *ATM Modular PHY Cards Installation* manual.

Table A-1 shows the states that are possible for each of the module's LEDs.

**Table A-1: Module LED States**

LED Name	Off	On (Green)	On (Yellow)	Flashing
Power LED 	No power or not enough power available in the MultiSwitch900 (formerly DEChub 900).	Module is receiving power.	N/A	N/A
Module OK LED 	Self-test has failed or is in progress.	Module passed self-test	N/A	Indicates a downline load or a nonfatal failure.
VNbus Status LED 	No connection.	Module is properly attached to one of the backplane VNbuses.	See release notes. <sup>1</sup>	<b>(Green)</b> VNbus is disconnected by management software.
VNbus Activity LED 	No traffic.	N/A	Heavy traffic. See release notes. <sup>1</sup>	<b>(Yellow)</b> Port is receiving/transmitting traffic on the backplane.
LDM Port Status LED 	No link established.	Proper link established.	N/A	Disabled.

<sup>1</sup> The VNbus Status and Activity LEDs have different indications during a load state. Refer to the VNswitch 900 Series Modules release notes for current descriptions.

## LED Descriptions

LED Name	Off	On (Green)	On (Yellow)	Flashing
LDM Activity LED →	N/A	Indicates high traffic.	N/A	Transmitting or receiving packets.
Port Status LEDs 	No valid link being received on the port. No cable is attached. Port is broken.	Port is enabled and is receiving a valid link.	Port failure.	<b>(Green)</b> Port is management disabled for forwarding but is still receiving a valid link.
Port Activity LEDs →	No traffic is being received/transmitted to the port.	Port is enabled onto the front panel and is receiving a valid link.	Port is enabled onto the backplane channel and is receiving a valid link. (In a DEChub ONE docking station or DIGITAL MultiSwitch 900).	<b>(Green)</b> Port is receiving/transmitting traffic on the front panel. <b>(Yellow)</b> Port is receiving/transmitting traffic on the backplane channel.



---

## Problem Solving Using LEDs

When diagnosing a problem with the module, note that the problem is often indicated by the combined states of the module LEDs. Table A-2 lists the typical combined states of the LEDs for various error conditions that can occur during initial installation of the device, along with probable causes and corrective actions to take.

---

### NOTE

If any of the following problems persist after taking corrective action, either replace the module or contact your DIGITAL service representative.

---

**Table A-2: Problem Solving Using the LEDs**

Symptom	Probable Cause	Corrective Action
Power LED is off.	The module is not receiving +5 Vdc.	<p>Check the power status on the Chassis Manager status display.</p> <p>If the Chassis Manager status display indicates that power is available for this module, press the release lever and reseal or remove the module.</p> <p>Inspect the module's 48- or 160-pin connector for bent or broken pins. If any are bent or broken, replace the module.</p>
Module OK LED is off.	Self-test failed.	If the LED does not light within 3 minutes, lift and reseal the release lever momentarily to repeat the self-test.

*(continued on next page)*

## Problem Solving Using LEDs

Symptom	Probable Cause	Corrective Action
Module OK LED is flashing, but module continues to operate normally.	A nonfatal error occurred.	Contact your service representative.
VNbus Status LED is off.	No connection.	Check that the module is properly attached to one of the backplane VNbuses and that the VNbus is connected by management software.
VNbus Activity LED is off.	There is low traffic activity or no traffic activity.	Ensure that there is traffic activity. If the VNbus traffic LED fails to turn on, then turn the module off momentarily by removing it from the power supply. Check that the VNbus Traffic LED blinks momentarily during the LED power-up self-test.
	The module or any other unit in the MultiSwitch 900 may not be connected to an active VNbus channel.	Connect a known active VNbus channel to any unit in the MultiSwitch 900.
	If the module is connected to an active VNbus and the VNbus Traffic LED is off, the module is defective.	Replace the module.
LDM Port Status LED is off.	No link established.	Check that a proper link has been established.
Port Status LEDs are off.	No cable attached or port is broken.	Check cable type.

## Problem Solving Using LEDs

<b>Symptom</b>	<b>Probable Cause</b>	<b>Corrective Action</b>
Port Activity LEDs are off.	There is low or no port activity.	Ensure that the port is present. If the Port Activity LED still fails to turn on, then turn the module off momentarily by removing it from the power supply. Check that the Port Activity LEDs blink momentarily during the LED power-up self-test.
	Ensure that the cable has activity on it. If the LED still fails to turn on, the module is defective.	Replace the module.



# Appendix B

---

## Connectors and Adapters

---

### Overview

#### Introduction

This appendix shows detailed illustrations of the connectors, their pin assignments, and adapters used on the DIGITAL VNswitch 900XA module.

#### In This Appendix

Topic	Page
Connectors and Pin Assignments	B-2
Adapters	B-3

---

## Connectors and Pin Assignments

The VNswitch 900XA uses a straight-through connector for its LDM port.

### 10BaseT (8-pin MJ) Straight-Through Connector

Figure B-1 shows the 8-pin MJ straight-through port connector and its pin assignments.

**Figure B-1: 8-Pin MJ Straight-Through Connector**

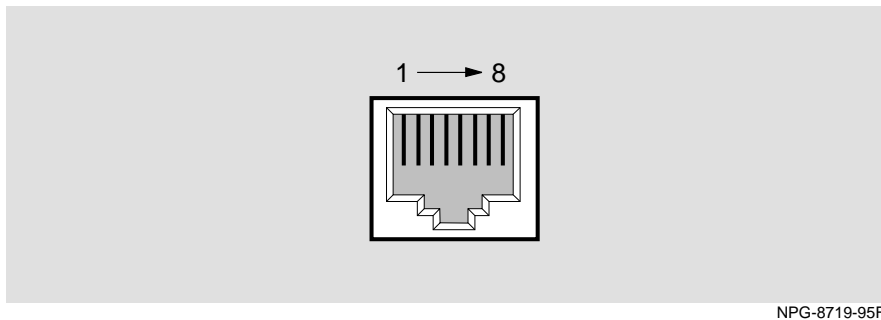

NPG-8719-95F

Table B-1 lists the pin assignments for the 8-pin MJ straight-through connector.

**Table B-1: 8-pin MJ Straight-Through Connector Pin Assignments**

Pin	Assignment	Pin	Assignment
1	TX+	5	NC
2	TX-	6	RX-
3	RX+	7	NC
4	NC	8	NC

## Adapters

### H8571-J Adapter

Figure B-2 shows the H8571-J adapter (6-pin MMJ connector to 9-pin D-sub connector) and its pin assignments.

**Figure B-2: H8571-J Adapter**

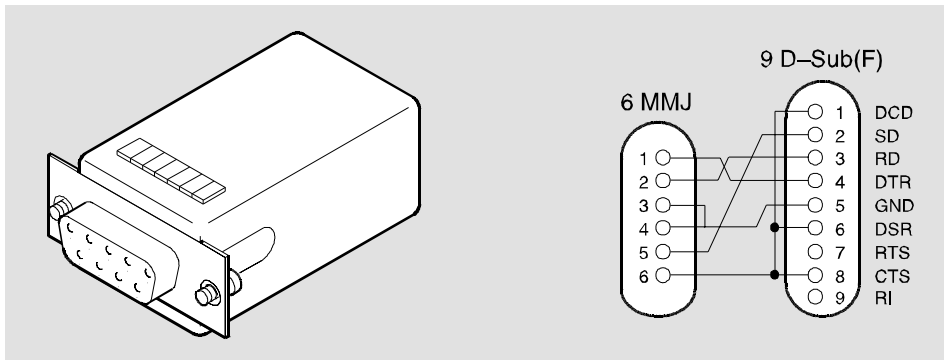

NPG-5342-95F

### H8575-A Adapter

Figure B-3 shows the H8575-A adapter (6-pin MMJ connector to 25-pin D-sub connector) and its pin assignments.

**Figure B-3: H8575-A Adapter**

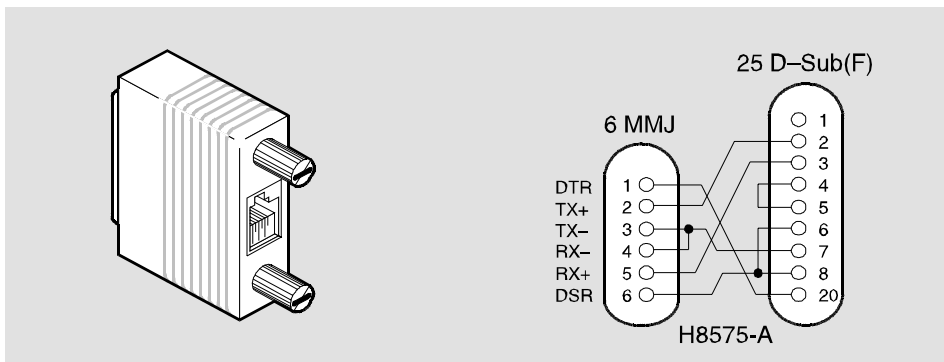

NPG-8793-95F





# Appendix C

---

## Product Specifications

---

### Overview

#### Introduction

This appendix lists the product and acoustical specifications for the DIGITAL VNswitch 900XA module. It also provides a list of connectors on the VNswitch 900XA module, the DIGITAL MultiSwitch 900 (formerly DEChub 900 MultiSwitch), and the DEChub ONE and DEChub ONE-MX docking stations.

#### In This Appendix

Topic	Page
Product Specifications	C-2
Acoustical Specifications	C-3
Connectors	C-4

---

## Product Specifications

Table C-1 lists the product specifications for the module.

**Table C-1: Product Specifications**

<b>Parameter</b>	<b>Specification</b>
<b>Environment</b>	
Operating temperature <sup>1</sup>	5°C to 50°C (41°F to 122°F)
Relative Humidity	10% to 95% noncondensing
Altitude	
• Operating	Sea level to 4267 m (14,000 ft)
• Nonoperating	Sea level to 12192 m (40,000 ft)
<b>Power</b>	50.5 W, total power 8.6 A, 5 Vdc 0.12 A, 12 Vdc 0.52 A, 15 Vdc
<b>Physical</b>	
Height	44.45 cm (17.5 in)
Width	4.45 cm (1.75 in)
Depth	15.25 cm (6 in)
Weight	1.82 kg (4.0 lb)
<b>Shock (Class A/B for products weighing under 100 lb)</b>	10 G / 10 ms half sine pulse in three orthogonal axes
<b>Vibration (Class C)</b>	5 to 200 Hz sine sweep @ 0.25 G limited by 0.5mm (0.02 in) displacement DA* 200 to 500 Hz sine sweep @ 0.10 G
<b>Certification</b>	CE, CSA, FCC, TÜV, UL, VCCI

<sup>1</sup> For sites above 2400 m (8,000 ft), decrease the operating temperature specification by 1.8°C for each 1000 m or 3.2°F for each 3200 ft.

## Acoustical Specifications

Table C-2 and Table C-3 list the acoustical specifications for the module in English and German.

**Table C-2: English Acoustical Specifications**

Declared Values per ISO 9296 and ISO 7779<sup>1</sup>

Product	Sound Power Level	Sound Pressure Level
	$L_{WA,d}$ , B	$L_{pAm}$ , dBA (bystander positions)
	Idle/Operate	Idle/Operate
DVNXA	5.1	37
DVNXA + DEHUA	5.4	40
DVNXA + DEF1H	5.3	40

<sup>1</sup> Current values for specific configurations are available from Digital Equipment Corporation representatives. 1 B = 10 dBA.

**Table C-3: German Acoustical Specifications**

Schallemissionswerte Werteangaben nach ISO 9296 und ISO 7779/DIN EN27779<sup>2</sup>

Produkt	Schalleistungspegel	Schalldruckpegel
	$L_{WA,d}$ , B	$L_{pAm}$ , dBA (Zuschauerpositionen)
	Leerlauf/Betrieb	Leerlauf/Betrieb
DVNXA	5, 1	37
DVNXA + DEHUA	5, 4	40
DVNXA + DEF1H	5, 3	40

<sup>2</sup> Aktuelle Werte für spezielle Ausrüstungsstufen sind über die Digital Equipment Vertretungen erhältlich. 1 B = 10 dBA.

---

## Connectors

Table C-4 provides a list of connectors for VNswitch 900XA module, the DIGITAL MultiSwitch 900, and the DEChub ONE and DEChub ONE-MX docking stations.

**Table C-4: Connectors**

Connectors	Quantity
<b>VNswitch 900XA</b>	
8-pin MJ (10BaseT twisted pair)	1
<b>MultiSwitch 900</b>	
8-pin MJ (setup port)	1
DB-9 (OBM)	1
<b>DEChub ONE</b>	
8-pin MJ (setup port)	1
DB-9 (OBM)	1
15-pin D-Sub (AUI Connector)	1
<b>DEChub ONE-MX</b>	
8-pin MJ (setup port)	1
6-pin MJ (OBR)	1
DB-9 (OBM)	1
15-pin D-Sub (AUI)	1
Redundant power connector (D-sub)	1
Mod PMD slots	2

For information on connectors for the 100 Mb/s Fast Ethernet (MM-100) card, refer to the *100 Mb/s Fast Ethernet Modular Media Interface Cards Installation* manual.

For information on connectors for the ATM Modular PHY (modPHY) card, refer to the *ATM Modular PHY Cards Installation* manual.