

Z-Family™ GPS Receivers

Technical Reference Manual



Z-Xtreme Receiver



ZX-Sensor

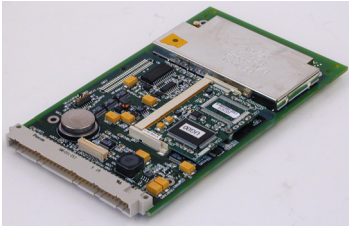

ZX-Eurocard

Thales Navigation
471 El Camino Real
Santa Clara, CA USA 95050-4300

Phone and Fax Numbers

- **Main**
 - Voice: +1 408-615-5100
 - Fax: +1 408-615-5200
- **Sales**
 - US: 1-800-922-2401
 - International: +1 408-615-3970
 - Fax: +1 408-615-5200
- **Europe (France)**
 - Voice: +33 2 28 09 38 00
 - Fax: +33 2 28 09 39 39
- **South America**
 - Voice: +56 2 234 56 43
 - Fax: +56 2 234 56 47
- **Support**
 - US: 1 800-229-2400
 - International: +1 408-615-3980
 - Fax: +1 408-615-5200

Internet

- ashtechsupport@thalesnavigation.com
- <http://www.ashtech.com>
- <http://www.thalesnavigation.com>



Copyright Notice

Copyright © 2002 Thales Navigation. All rights reserved.

No part of this publication or the computer programs described in it may be reproduced, translated, stored in a retrieval system, or transmitted in any form or by any means, electronic, mechanical photocopying, recording, or otherwise, without prior written permission of Thales Navigation. Your rights with regard to this publication and the computer programs are subject to the restrictions and limitations imposed by the copyright laws of the United States of America (“U.S.A.”) and/or the jurisdiction in which you are located.

Printed in the United States of America.

Part Number: 630203-01 Revision C

July 2002

Trademarks

Z-Xtreme™, Instant-RTK™, Z-Tracking™, Z-Surveyor™, Z-FX™, Z-Sensor™, Z-Euro-card™, ZX-Sensor™, ZX-Eurocard™, GPS Topo™, and the Thales Navigation logo are trademarks of Thales Navigation. Ashtech® is a registered trademark of Thales Navigation. All other products and brand names are trademarks or registered trademarks of their respective holders.

SOFTWARE LICENSE AGREEMENT

IMPORTANT: BY OPENING THE SEALED DISK PACKAGE CONTAINING THE SOFTWARE MEDIA, YOU ARE AGREEING TO BE BOUND BY THE TERMS AND CONDITIONS OF THE LICENSE AGREEMENT (“AGREEMENT”). THIS AGREEMENT CONSTITUTES THE COMPLETE AGREEMENT BETWEEN YOU (“LICENSEE”) AND THALES NAVIGATION (“LICENSOR”). READ THE AGREEMENT CAREFULLY. IF YOU DO NOT AGREE WITH THE TERMS, RETURN THIS UNOPENED DISK PACKAGE AND THE ACCOMPANYING ITEMS TO THE PLACE WHERE YOU OBTAINED THEM FOR A FULL REFUND.

LICENSE. LICENSOR grants to you a limited, non-exclusive, non-transferable, personal license (“License”) to (i) install and operate the copy of the computer program contained in this package (“Program”) in machine acceptable form only on a single computer (one central processing unit and associated monitor and keyboard) and (ii) to make one archival copy of the Program for use with the same computer. LICENSOR and its third-party suppliers retain all rights to the Program not expressly granted in this Agreement.

OWNERSHIP OF PROGRAMS AND COPIES. This License is not a sale of the original Program or any copies.

LICENSOR and its third-party suppliers retain the ownership of the Program and all copyrights and other proprietary rights therein, and all subsequent copies of the Program made by you, regardless of the form in which the copies may exist. The Program and the accompanying manuals (“Documentation”) are copyrighted works of authorship and contain valuable trade secret and confidential information proprietary to the LICENSOR and its third-party suppliers. You agree to exercise reasonable efforts to protect the proprietary interests of LICENSOR and its third-party suppliers in the Program and Documentation and maintain them in strict confidence.

USER RESTRICTIONS. The Program is provided for use in your internal commercial business operations and must remain at all times upon a single computer owned or leased by you. You may physically transfer the Program from one computer to another provided that the Program is operated only on one computer at a time. You may not operate the Program in a time-sharing or service bureau operation, or rent, lease, sublease, sell, assign, pledge, transfer, transmit electronically or otherwise dispose of the Program or Documentation, on a temporary or permanent basis, without the prior written consent of LICENSOR. You agree not to translate, modify, adapt, disassemble, decompile, or reverse engineer the Program, or create derivative works of the Program or Documentation or any portion thereof.

TERMINATION. The License is effective until terminated. The License will terminate without notice from LICENSOR if you fail to comply with any provision of this Agreement. Upon termination, you must cease all use of the Program and Documentation and return them and any copies thereof to LICENSOR.

GENERAL. This Agreement shall be governed by and construed in accordance with the Laws of the State of California and the United States without regard to conflict of laws and provisions thereof and without regard to the United Nations Convention on Contracts for the International Sale of Goods.

Unless modified in writing and signed by both parties, this warranty is understood to be the complete and exclusive agreement between the parties, superseding all prior agreements, oral or written, and all other communications between the parties relating to a warranty of the Product. No employee of Thales Navigation or any other party is authorized to make any warranty in addition to those made in this document. This warranty allocates the risks of product failure between Thales Navigation and the buyer. This allocation is recognized by both parties and is reflected in the price of the goods. The buyer acknowledges that it has read warranty, understands it, and is bound by its terms.

This limited warranty is governed by the laws of the State of California, without reference to its conflict of law provisions or the U.N. Convention on Contracts for the International Sale of Goods.



To the extent the foregoing provisions differ from the terms of the sales contract between the buyer and Thales Navigation, the sales contract will take precedence. The sales contract contains procedural qualifications and other contractual terms relating to the foregoing provisions.

DISCLAIMER OF WARRANTIES AND LIMITATION OF LIABILITY

LICENSOR AND ITS THIRD-PARTY SUPPLIERS MAKE NO WARRANTIES OR REPRESENTATIONS, EXPRESS OR IMPLIED, REGARDING THE PROGRAM, MEDIA, DOCUMENTATION, RESULTS OR ACCURACY OF DATA AND HEREBY EXPRESSLY DISCLAIM ANY WARRANTIES OF MERCHANTABILITY AND FITNESS FOR A PARTICULAR PURPOSE AND NONFRINGEMENT. LICENSOR AND ITS THIRD PARTY SUPPLIERS DO NOT WARRANT THE PROGRAM WILL MEET YOUR REQUIREMENTS OR THAT ITS OPERATION WILL BE UNINTERRUPTED OR ERROR-FREE.

LICENSOR, its third-party suppliers, or anyone involved in the creation or delivery of the Program or Documentation to you shall have no liability to you or any third-party for special, incidental, indirect or consequential damages (including, but not limited to, loss of profits or savings, downtime, damage to or replacement of equipment or property, or recovery or replacement of programs or data) arising from claims based in warranty, contract, tort (including negligence), strict liability, or otherwise even if LICENSOR and its third-party have been advised of the possibility of such claim or damages. The liability of LICENSOR and its third-party suppliers for direct damages shall not exceed the actual amount paid for the program license.

Some States do not allow the exclusion of limitation of implied warranties or liability for incidental or consequential damages, so the above limitations or exclusions may not apply to you.

MANUAL DISCLAIMER

THIS MANUAL IS PROVIDED "AS IS"; Thales Navigation MAKES NO WARRANTIES TO ANY PERSON OR ENTITY WITH RESPECT TO THE SUBJECT MATTER OR USE OF INFORMATION CONTAINED HEREIN OR ANY DERIVATIVES THEREOF OR ANY SERVICES OR LICENSES. Thales Navigation DISCLAIMS ALL IMPLIED WARRANTIES, INCLUDING, WITHOUT LIMITATION, WARRANTIES OF MERCHANTABILITY AND FITNESS FOR A PARTICULAR PURPOSE AND NONINFRINGEMENT. FURTHER, Thales Navigation DOES NOT WARRANT, GUARANTEE, OR MAKE ANY REPRESENTATIONS REGARDING THE USE, OR THE RESULTS OF THE USE, OF THIS MANUAL IN TERMS OF CORRECTNESS, ACCURACY, RELIABILITY, OR OTHERWISE. THIS PUBLICATION AND FEATURES DESCRIBED HEREIN ARE SUBJECT TO CHANGE WITHOUT NOTICE.

U.S. GOVERNMENT RESTRICTED RIGHTS

The Program and Documentation are provided with RESTRICTIVE RIGHTS. Use, duplication, or disclosure by the Government is subject to restrictions as set forth in subdivision (c)(1)(ii) of the Rights in Technical Data and Computer Software clause at DFARS 252.227-7013 or subdivision 9(c)(1) and (2) of the Commercial Computer Software - Restricted Rights 48 CFR 52.227.19, as applicable.

Should you have any questions concerning the License Agreement or the Limited Warranties and Limitation of Liability, please contact Thales Navigation in writing at the following address: 471 El Camino Real, Santa Clara, CA 95050-4300

Table of Contents

Chapter 1. Introduction	1
Performance Specifications	2
Receiver Options	2
[B] RTCM Base	3
[U] RTCM Remote	3
[E] Event Marker	4
[M] Remote Monitoring	4
[F] Fast Data Output	4
[G] Reserved For future option	4
[H] 5 Hz Synchronized RTK	4
[N] Reserved for Future Option	4
[T] Point Positioning	4
[3] Observables—1, 2, 3	5
[J] RTK Rover	5
[K] RTK Base	5
[I] Instant RTK	5
Chapter 2. Operation	7
Receiver Initialization	7
Setting Receiver Parameters	7
Saving Parameter Settings	8
Data Recording (Z-Xtreme, Z-Surveyor, Z-FX only)	8
Setting the Data Recording Interval	8
PCMCIA Card	9
Formatting the PC Card	10
PCMCIA File Structure	11
Data Modes	12
Downloading the Data	13
Data Logging through Serial Port	13

Elevation Masks	13
Secondary Elevation Mask	14
Zenith Elevation Mask	15
Session Programming	15
Position Mode	17
ALT Fix Mode	17
Daisy Chain Mode	18
Point Positioning	18
Remote Monitoring	18
Event Marker	19
Time Tagging the Shutter Signal	20
Closed-Loop Technique (Advanced Trigger)	20
1PPS Out	21
Data Output	21
Transferring Data Files	22
Synchronization to GPS Time	22
Default Parameters	23
Multipath Mitigation	27
Evaluating Correlator Performance	28
Signal-to-Noise Ratio	30
Antenna Reduction	30
Chapter 3. Differential and RTK Operations	33
Base Stations	33
Setting Up a Differential Base Station	33
Setting Up an RTK Base Station	34
RTCM 18 & 19	34
RTCM 20 & 21	35
Ashtech DBEN Format	36
CMR Format	37
Setting Up a Combined Differential & RTK Base Station	38
Advanced Base Station Operation	39
Recommended Advanced Parameter Settings for Base Stations	39
Antenna	39
Message Rate	39
Required Differential Update Rates	40
Mask Angle	43
Base Station Position	43
Base Station Antenna Offset	43
Using Reference Station ID	44
Reference Station Health	44
Other RTCM Messages	44
Using a PC Interface	45

Using a Handheld Interface	45
Remote Stations	46
Setting Up a Differential Remote Station	46
Setting Up an RTK Remote Station	46
Using RTCM Messages	46
Using Ashtech DBN or CMR Messages	47
Advanced Remote Station Operation	48
Base Station Data	48
Base Data Latency	49
Differential Accuracy vs. Base Data Latency	50
Choosing Between Fast RTK and Synchronized RTK	50
Float and Fixed Solutions	52
Carrier Phase Initialization	53
Mask Angles	54
Auto Differential Mode	54
RTCM Messages	55
Chapter 4. Understanding RTK/CPD	57
Monitoring the CPD Rover Solution	57
How to Tell If the Integer Ambiguities are Fixed	58
Data Link Monitor	58
CPD Solution Output and Storage	58
Real-time Solution Output.	59
Vector Solution Output	59
Solution Storage	60
Troubleshooting	62
System Performance Optimization	64
Ambiguity Fix: \$PASHS,CPD,AFP	64
Dynamics: \$PASHS,CPD,DYN.	65
Fast CPD: \$PASHS,CPD,FST	66
Multipath: \$PASHS,CPD,MTP	66
DBN Message Interval: \$PASHS,CPD,PED and CPD Update Rate:	
\$PASHS,CPD,PER	66
Initialization: \$PASHS,CPD,RST	67
Base Position Coordinates Selection: \$PASHS,CPD,UBS.	67
Base Station Elevation Mask: \$PASHS,ELM	67
Universal RTCM Base Station	67
Instant-RTK.	68
CMR Format	69
Setting Up Your Receivers to Use CMR Format	69
Chapter 5. Coordinate Transformation.	71
Background	71
Datum to Datum	72

Datum to Grid	74
Projection Types	76
Elevation Modeling	78
Chapter 6. Command/Response Formats	81
Receiver Commands	83
Set Commands	83
Query Commands	83
ALH: Almanac Messages Received	88
ALT: Set Ellipsoid Height	88
ANA: Post-Survey Antenna Height	88
ANH: Set Antenna Height	89
ANR: Set Antenna Reduction Mode	89
ANT: Set Antenna Offsets	90
BEEP: Beeper Set-up	92
CLM: Clear/Reformat PCMCIA Card	92
CSN: Satellite Signal to Noise	93
Table 6.8 describes each parameter in the CSN message.	93
CTS: Port Protocol Setting	94
DOI: Data Output Interval	94
DRI: Data Recording Interval	95
DSC: Store Event String	95
DSY: Daisy Chain	95
ELM: Recording Elevation Mask	96
EPG: Epoch Counter	96
FIL,C: Close a File	96
FIL,D: Delete a File	97
FIX: Altitude Fix Mode	97
FLS: Receiver File Information	97
FSS: File System Status	99
HDP: HDOP Mask	100
INF: Set Session Information	100
INI: Receiver Initialization	104
ION: Set Ionospheric Model	106
ION: Query Ionospheric Parameters	106
LPS: Loop Tracking	108
LTZ: Set Local Time Zone	108
MDM: Set Modem Parameters	109
MDM,INI: Initialize Modem Communication	110
MET: Meteorological Meters Set-up	111
MET,CMD: Meteorological Meters Trigger String	111
MET,INIT: Meteorological Meters Initialization	112
MET,INTVL : Meteorological Meters Interval	112

MST: Minimum SVs for Kinematic Survey	112
MSV: Minimum SVs for Data Recording	113
OUT,MET: Start Meteorological Meters Process	113
OUT, TLT: Start Tiltmeter Process	113
PAR: Query Receiver Parameters	114
PDP: PDOP Mask	117
PEM: Position Elevation Mask	117
PHE: Photogrammetry Edge (Event Marker Edge)	117
PJT: Log Project Data	118
PMD: Position Mode	119
POS: Set Antenna Position	119
POW: Battery Parameters	121
PPO: Point Positioning	122
PPS: Pulse Per Second	122
PRT: Port Setting	123
PWR: Sleep Mode	125
RCI: Recording Interval	125
REC: Data Recording	125
RID: Receiver ID	126
RNG: Data Type	127
RST: Reset Receiver to default	127
RTR: Real-Time Error	127
SAV: Save User Parameters	128
SEM: Secondary Elevation Mask	128
SES: Session Programming	129
SID: Serial Number	133
SIT: Set Site Name	134
SPD: Serial Port Baud Rate	134
STA: Satellite Status	135
SVS: Satellite Selection	135
TLT : Tiltmeter Set-up	136
TLT,CMD: Tiltmeter Trigger String	136
TLT,INIT : Tiltmeter Initialization	137
TLT,INTVL: Tiltmeter Interval	137
TMP: Receiver Internal Temperature	138
TST:Output RTK Latency	138
UNH: Unhealthy Satellites	139
USE: Use Satellites	139
VDP: VDOP Mask	139
WAK: Warning Acknowledgment	139
WARN: Warning Messages	139
WKN: GPS Week Number	144
Raw Data Commands	145

Set Commands	145
Query Commands	146
CBN: CBEN Message	148
CMR: CMR Message	153
Compact Measurement Record Packet	156
Observables (Message Type 0)	156
L2 Data	158
DBN: DBEN Message	159
EPB: Raw Ephemeris	164
MBN: MBN Message	167
OUT: Enable/Disable Raw Data Output	172
PBN: Position Data	172
RAW: Query Raw Data Parameter	175
RWO: Raw Data Output Settings	177
SAL: Almanac Data	177
SNV: Ephemeris Data	178
NMEA Message Commands	181
Set Commands	181
Query Commands	183
ALL: Disable All NMEA Messages	185
ALM: Almanac Message	185
CRT: Cartesian Coordinates Message	187
DAL: DAL Format Almanac Message	190
DCR: Delta Cartesian Message	194
DPO: Delta Position Message	195
GDC: User Grid Coordinate	198
GGA: GPS Position Message	202
GLL: Latitude/Longitude Message	206
GRS: Satellite Range Residuals	207
GSA: DOP and Active Satellite Messages	209
GSN: Signal Strength/Satellite Number	210
GST: Pseudo-range Error Statistic Message	213
GSV: Satellites in View Message	213
GXP: Horizontal Position Message	215
MSG: Base Station Message	217
NMO: NMEA Message Output Settings	222
PER: Set NMEA Send Interval	223
POS: Position Message	223
PTT: Pulse Time Tag Message	225
RMC: Recommended Minimum GPS/Transit	226
RRE: Residual Error	228
SAT: Satellite Status	231
TAG: Set NMEA Version	232

TTT: Event Marker	233
UTM: UTM Coordinates	234
VTG: Velocity/Course	236
XDR: Transducer Measurements	238
ZDA: Time and Date	239
RTCM Response Message Commands	242
Set Commands	242
Query Commands	242
Query: RTCM Status	243
AUT: Auto Differential	246
BAS: Enable Base Station	246
EOT: End of Transmission	246
INI: Initialize RTCM	246
IOD: Ephemeris Data Update Rate	247
MAX: Max Age	247
MSG: Define Message	247
MSI: Query RTCM Message Status	247
OFF: Disable RTCM	249
QAF: Quality Factor	249
REM: Enable Remote RTCM	249
SEQ: Check Sequence Number	250
SPD: Base Bit Rate	250
STH: Station Health	250
STI: Station ID	251
TYP: Message Type	251
CPD Commands	253
Set Commands	253
Query Commands	253
CPD: RTK Status	256
AFP: Ambiguity Fixing	259
ANT: Antenna Parameters	259
CMR: CMR Received Mode	260
DLK: Data Link Status	260
DYN: Rover Dynamics	265
ENT: Use Current Position	265
EOT: End of Transmission	265
FST: Fast CPD Mode	266
INF: CPD Information	266
MAX: Max Age for CPD Correction	268
MOD: CPD Mode	268
MTP: Multipath	269
OBN: Vector Solution Information	270
OUT: Solution Output	273

PEB: Base Broadcast Interval	273
PED: DBEN/CMR Transmission Period	274
PER: CPD Update Interval	274
POS: Set Base Position	275
PRO: Select RTK Format	275
PRT: Port Output Setting	276
RST: Reset CPD	276
STS: CPD Solution Status	276
UBP: Use Base Position	277
UCT Commands	278
DTM: Datum Selection	279
FUM: Fix UTM Zone	279
FZN: Set UTM Zone to Fix	280
GRD: Datum-to-Grid Transformation Selection (Map Projection)	280
HGT: Height Model Selection	280
UDD: User-Defined Datum	281
UDG: User-Defined Datum-to-Grid Transformation	283
Appendix A. Reference Datums & Ellipsoids	289
Appendix B. Global Product Support	293
Solutions for Common Problems	294
Corporate Web Page	294
Repair Centers	294
Index	295

List of Figures

Figure 2.1.	File Naming Convention	11
Figure 2.2.	Secondary Elevation Mask (SEM) Zone	14
Figure 2.3.	ZEN (Zenith) Elevation Mask Zone	15
Figure 2.4.	Event Marker Time Measurement	19
Figure 2.5.	Closed Loop Technique.	20
Figure 2.6.	Relative Performance of Multipath Mitigation Techniques.	28
Figure 2.7.	Detailed View of Multipath Mitigation Performance	29
Figure 3.1.	Combined Differential/RTK Base Station and Remote Operation . .	49
Figure 3.2.	DGPS Accuracy.	50
Figure 4.1.	Ambiguity Fix Test Results	65
Figure 5.1.	Rotation and Translation Between Coordinate Systems	74
Figure 5.2.	Mercator	76
Figure 5.3.	Transverse Mercator	77
Figure 5.4.	Oblique Mercator.	77
Figure 5.5.	Stereographic	78
Figure 5.6.	Lambert Conformal Conic	78

List of Tables

Table 1.1.	Accuracy as Function of Mode.	2
Table 1.2.	Options.	3
Table 2.1.	Recording Modes.	12
Table 2.2.	File Types	13
Table 2.3.	Position Modes	17
Table 2.4.	Default Values	24
Table 3.1.	Differential Base Station Commands.	34
Table 3.2.	RTK Base Station Commands - Types 18 and 19.	35
Table 3.3.	RTK Base Station Commands - Types 20 and 21.	35
Table 3.4.	RTK Base Station Commands - DBEN	36
Table 3.5.	RTK Base Station Commands - CMR Format	37
Table 3.6.	Base Station Commands - Combined Differential and RTK.	38
Table 3.7.	Message Size for RTCM Messages 18 & 19 or 20 & 21	40
Table 3.8.	Message Size For Ashtech DBN Messages	41
Table 3.9.	Minimum Baud Rates for RTCM Messages 18 & 19 or 20 & 21	41
Table 3.10.	Minimum Baud Rates for Ashtech DBN Messages	41
Table 3.11.	Maximum Number of Satellites Above a 4° Mask Angle	42
Table 3.12.	Differential Remote Station Commands.	46
Table 3.13.	RTK Remote Station Command	47
Table 3.14.	RTK Remote Station Commands.	48
Table 3.15.	Auto Differential Modes and Position Output.	55
Table 3.16.	RTCM Message Types	56
Table 4.1.	Troubleshooting Tips	62
Table 4.2.	CPD optimization commands.	64
Table 4.3.	Default RTCM Message Schedules.	68
Table 4.4.	Percentage of Ambiguity Initialization Using a Single Epoch.	68
Table 5.1.	User Coordinate Transformation Functionalities	72
Table 5.2.	Ellipsoid Parameters for WGS-72 and WGS-84	73
Table 6.1.	Command Parameter Symbols	82

Table 6.2.	Receiver Commands	84
Table 6.3.	ALH Parameter Table	88
Table 6.4.	ANR Message Structure	89
Table 6.5.	Antenna Offsets Settings	90
Table 6.6.	ANT Message Structure	90
Table 6.7.	CLM Message Structure	93
Table 6.8.	CSN Message Structure	93
Table 6.9.	DSY Parameter Table	95
Table 6.10.	FIX Parameter Settings	97
Table 6.11.	FLS Message Structure	98
Table 6.12.	Typical FLS Message	99
Table 6.13.	FSS Message Structure	100
Table 6.14.	INF Parameter Table	100
Table 6.15.	INF Message Structure	102
Table 6.16.	INI Parameter Description Table	104
Table 6.17.	Baud Rate Codes	104
Table 6.18.	Reset Memory Codes	104
Table 6.19.	ION Message Structure	106
Table 6.20.	LPS Message Structure	108
Table 6.21.	MDM Setting Parameters and Descriptions	109
Table 6.22.	Baud Rate Codes	109
Table 6.23.	MDM Message Structure	110
Table 6.24.	MET,CMD Message Structure	111
Table 6.25.	MET,INIT Message Structure	112
Table 6.26.	MET,INTVL Message Structure	112
Table 6.27.	MST Parameter Table	113
Table 6.28.	OUT,MET Message Structure	113
Table 6.29.	OUT,TLT Message Structure	114
Table 6.30.	PAR Parameter Table	115
Table 6.31.	PHE Parameter Table	117
Table 6.32.	PHE Message Structure	118
Table 6.33.	PJT Parameter Table	118
Table 6.34.	PMD Parameter Table	119
Table 6.35.	POS Parameter Table	119
Table 6.36.	POW Parameter Table	121
Table 6.37.	POW Message Structure	121
Table 6.38.	PPO Parameter Table	122
Table 6.39.	PPS Message Structure	122
Table 6.40.	PPS Response Structure	123
Table 6.41.	PRT Response Structure	123
Table 6.42.	Baud Rate Codes	124
Table 6.43.	REC Message Structure	126
Table 6.44.	RID Message Structure	126

Table 6.45.	RNG Data Modes	127
Table 6.46.	RTR Message Structure	128
Table 6.47.	SES,PAR Message Structure	129
Table 6.48.	SES,SET Message Structure	130
Table 6.49.	SES Message Structure	132
Table 6.50.	SSN Message Structure	133
Table 6.51.	SPD Baud Rate Codes	134
Table 6.52.	STA Message Structure	135
Table 6.53.	TLT,CMD Message Structure	137
Table 6.54.	TLT,INIT Message Structure	137
Table 6.55.	TLT,INTVL Message Structure	137
Table 6.56.	TMP Message Structure	138
Table 6.57.	TST Message Structure	138
Table 6.58.	WARN Message Structure	140
Table 6.59.	Receiver Warning Messages	140
Table 6.60.	WKN Message Structure	144
Table 6.61.	Raw Data Types and Formats	146
Table 6.62.	Raw Data Commands	148
Table 6.63.	CBN Message Structure (ASCII Format)	149
Table 6.64.	Solution Type Flag Table (ASCII Format)	150
Table 6.65.	CBN Message Structure (Binary Format)	150
Table 6.66.	Solution Type Flag Structure (Binary Format)	153
Table 6.67.	Compact Measurement Record Structure	154
Table 6.68.	Compact Measurement Record Packet Definition	156
Table 6.69.	CMR Type 0 Message Header	156
Table 6.70.	CMR Type 0 Message Observables Block	158
Table 6.71.	CMR Type 0 Message Observables Block (L2)	159
Table 6.72.	RPC Message Structure	160
Table 6.73.	RPC Packed Parameter Descriptions	160
Table 6.74.	DBEN Message Sizes	162
Table 6.75.	BPS Message Structure	162
Table 6.76.	BPS Status Byte Definition	164
Table 6.77.	EPB Response Format	165
Table 6.78.	MPC Measurement Structure (Binary Format)	167
Table 6.79.	MPC Message Structure (ASCII Format)	169
Table 6.80.	Warning Flag Settings	170
Table 6.81.	Measurement Quality (Good/Bad Flag)	171
Table 6.82.	OUT Message Structure	172
Table 6.83.	PBN Message Structure (ASCII Format)	173
Table 6.84.	PBN Message Structure (Binary Format)	173
Table 6.85.	RAW Message Structure	175
Table 6.86.	RWO Message Structure	177
Table 6.87.	ALM Message Structure	178

Table 6.88.	SNV Message Structure	179
Table 6.89.	NMEA Data Message Commands	183
Table 6.90.	ALM Response Message	185
Table 6.91.	Typical ALM Response Message	187
Table 6.92.	CRT Message Structure	189
Table 6.93.	DAL Message Structure	190
Table 6.94.	Typical DAL Message	193
Table 6.95.	DCR Message Structure	195
Table 6.96.	DPO Message Structure	197
Table 6.97.	GDC Message Structure	198
Table 6.98.	Typical GDC Response Message	201
Table 6.99.	GGA Message Structure	202
Table 6.100.	Typical GGA Message	205
Table 6.101.	GLL Message Structure	206
Table 6.102.	Typical GLL Message	207
Table 6.103.	GRS Message Structure	208
Table 6.104.	Typical GRS Message	208
Table 6.105.	GSA Message Structure	209
Table 6.106.	Typical GSA Message	210
Table 6.107.	GSN Message Structure	211
Table 6.108.	Typical GSN Message	211
Table 6.109.	GST Message Structure	213
Table 6.110.	GSV Message Structure	214
Table 6.111.	Typical GSV Message	215
Table 6.112.	GXP Message Structure	216
Table 6.113.	Typical GXP Message	216
Table 6.114.	Common Fields of Type 1, 2, 3, 6, 16, 18, 19, 20 and 21	218
Table 6.115.	Remainder of Type 1 Message	218
Table 6.116.	Remainder of Type 2 Message	219
Table 6.117.	Remainder of Type 3 Message	219
Table 6.118.	Remainder of Type 16 Message	219
Table 6.119.	Remainder of Type 18 and 20 Messages	220
Table 6.120.	Remainder of Type 19 and 21 Messages	220
Table 6.121.	NMO Message Structure	222
Table 6.122.	POS Message Structure	224
Table 6.123.	Typical POS Message	225
Table 6.124.	PTT Message Structure	226
Table 6.125.	Typical PTT Response Message	226
Table 6.126.	RMC Message Structure	227
Table 6.127.	Typical RMC Response	228
Table 6.128.	RRE Message Structure	229
Table 6.129.	Typical RRE Message	229
Table 6.130.	SAT Message Structure	231

Table 6.131.	Typical SAT Message	232
Table 6.132.	NMEA Message Format Codes	233
Table 6.133.	\$PASHR,TTT Message Structure	234
Table 6.134.	UTM Message Structure	235
Table 6.135.	Typical UTM Response Message	236
Table 6.136.	VTG Message Structure.	237
Table 6.137.	Typical VTG Message	238
Table 6.138.	XDR Message Structure	239
Table 6.139.	ZDA Message Structure	240
Table 6.140.	Typical ZDA Response Message.	241
Table 6.141.	RTCM Commands	243
Table 6.142.	RTC Response Parameters	244
Table 6.143.	EOT Parameters	246
Table 6.144.	RTC,MSI Message Structure	249
Table 6.145.	Available Bit Rate Codes	250
Table 6.146.	RTC,STH Health of Base Station.	251
Table 6.147.	RTC,TYP Message Types	252
Table 6.148.	CPD Commands	254
Table 6.149.	CPD Status Message Structure	256
Table 6.150.	CPD,AFP Parameter Table	259
Table 6.151.	CPD,ANT Parameter Table	259
Table 6.152.	CPD,ANT Message Structure	260
Table 6.153.	CPD,DLK Message Structure	261
Table 6.154.	CPD,DLK Response Message Example - Rover Station.	263
Table 6.155.	CPD,DLK Response Message Example - Base Station	263
Table 6.156.	CPD,DYN Parameter Table	265
Table 6.157.	CPD,EOT Parameter Table	265
Table 6.158.	INF Message Structure	266
Table 6.159.	CPD,MOD Parameter Table	268
Table 6.160.	CPD,MOD Message Structure.	269
Table 6.161.	MTP Parameter Table	269
Table 6.162.	OBEN Message Structure (Binary Format)	270
Table 6.163.	CPD,OUT Parameter Table	273
Table 6.164.	CPD,PEB Parameter Table	273
Table 6.165.	CPD,PED Parameter Table	274
Table 6.166.	CPD,PER Parameter Table	274
Table 6.167.	CPD,POS Parameter Table	275
Table 6.168.	CPD,PRO Parameter.	276
Table 6.169.	CPD,STS Message Structure	277
Table 6.170.	CPD,UBP Parameter Table	277
Table 6.171.	UCT Commands	278
Table 6.172.	UDD Message Structure	281
Table 6.173.	UDG Structure for Equatorial Mercator	283

Table 6.174.	UDG Structure for Transverse Mercator	283
Table 6.175.	UDG Structure for Oblique Mercator	284
Table 6.176.	UDG Structure for Stereographic (Polar and Oblique).	284
Table 6.177.	UDG Structure for Lambert CC SPC83 (2 std parallels)	284
Table 6.178.	UDG Structure for Lambert Conic Conformal for SPC27.	286
Table 6.179.	UDG Structure for Transverse Mercator for SPC27.	287
Table 6.180.	UDG Structure for Transverse Mercator SPC27 Alaska Zone 2-9287	
Table A.1.	Available Geodetic Datums	289
Table A.2.	Reference Ellipsoids	291

Introduction

This manual provides detailed technical reference information for the Ashtech Z-Family of GPS receivers. This group includes the Z-Xtreme receiver, Z-Surveyor, Z-FX, Z-Sensor, Z-Eurocard, ZX-Sensor, and ZX-Eurocard. For specific information about physical characteristics, description, performance, and detailed operation of your particular receiver, please refer to the operation manual for that receiver.

This manual assumes you have the following:

- A good working knowledge of surveying techniques
- A basic understanding of the Global Positioning System
- An operational receiver

If you are totally unfamiliar with GPS and/or surveying techniques, you may need more information than this manual, or the receiver operation manual, provides. We suggest that you read some of the many books and magazines on the subject of GPS surveying in order to learn the basics. We encourage you to take a moment now to read the system warranty and to send in your warranty registration card. By doing so, you are assured of receiving news of all updates. If you have any questions about your receiver, please contact your local distributor.

Performance Specifications

One of the most important functions of the receiver is providing real-time position solutions with accuracy ranging from centimeter level to 100 meters. Table 1.1 summarizes the positioning modes and expected accuracy.

Table 1.1. Accuracy as Function of Mode

Positioning Mode	Typical Horizontal Accuracy (2drms), 5 SVs, PDOP<4	Maximum Update Rate	Maximum Operating Range
Autonomous	100 meters with SA on	5Hz (10Hz optional)	Anywhere
RTCM code differential	1.0 meters + 10 ppm	5Hz (10Hz optional)	Several hundred kilometers (depending upon datalink)
Static (post-processed)	5mm + 1ppm	5Hz (10Hz optional)	Several hundred kilometers (depending upon satellite geometry)
Real-time carrier phase differential in RTCM-RTK format or DBEN format	1.6cm +2ppm	5Hz (10Hz optional)	<15 kilometers (depending upon datalink)



All accuracies were computed from multiple trials of live satellite data collected in the San Francisco Bay area with receivers and Geodetic III antennas under average multipath conditions.

Receiver Options

Table 1.2 lists the available options. Each option is represented by a letter or number presented in a certain order. With the Z-Xtreme, Z-Surveyor, or the Z-FX, you can verify the installed options by going to the options table under the System Information (SYSINFO) menu through the front panel.

You can also verify the installed options by issuing the following command to the receiver using an external handheld controller or PC, as described in Chapter 6, *Command/Response Formats*.

```
$PASHQ,RID
```

The command displays the options on the external handheld controller or PC. For example:

```
$PASHR,RID,UZ,30,ZC00,BUEXMFT3JKIGHN,0A16*0B
```

If the letter or number is displayed in the response message, the option is available. If the letter/number is not displayed, the option is not available.

Table 1.2. Options

Option	Description
B	RTCM differential base
U	RTCM differential remote
E	Event marker
M	Remote monitor option
F	Fast data output (10Hz)
T	Point positioning
1,2,3	Observables
J	RTK rover
K	RTK base
I	Instant RTK
G	Reserved
H	5 Hz synchronized RTK
N	Reserved

[B] RTCM Base

The receiver can be set as an RTCM differential base station and can output real-time differential corrections when this option is enabled. The output is in RTCM-104, Version 2.3 format message types 1,3,6, 16 and 22 as well as RTCM Carrier Differential 18, 19, 20, and 21. For messages 18, 19, 20, and 21, the K option is also required.

[U] RTCM Remote

Real-time differential corrections are available when this option is enabled. The receiver decodes the RTCM-104, Version 2.3 format message types 1,3,6,9, 16, and 22 as well as types 18, 19, 20 and 21. For messages 18, 19, 20, and 21, the J option is also required.

[E] Event Marker

The [E] option enables storage of event times created from a trigger signal. The receiver measures and records event times with high accuracy (down to one microsecond). The receiver stores an event time at the rising edge of the trigger signal (or the falling edge on command) and the time is recorded in the receiver's PC memory card and/or output in the TTT NMEA message.

[M] Remote Monitoring

The remote monitoring option allows you to use the REMOTE.EXE to access and control the receiver via a modem from a remote location. This option is required for GPSTopo™.

[F] Fast Data Output

This option enables the receiver to be programmed to output both raw position data and NMEA messages or record data (if a PCMCIA card is present in the receiver) at user-selectable frequencies up to 10Hz. Without this option, only frequencies up to 5Hz are available.

[G] Reserved For future option

[H] 5 Hz Synchronized RTK

The [H] option enables the receiver to output synchronized or matched time tag RTK positions at rate of up to 5 Hz (5 positions per second). 5 Hz Synchronized RTK allows the better accuracy of matched time tag RTK with nearly the same productivity of Fast CPD. This feature is only available when using DBEN or CMR format data.

[N] Reserved for Future Option

[T] Point Positioning

The [T] option allows you to put the receiver into point positioning mode using the \$PASHS,PPO command. Point positioning mode improves the accuracy of an autonomous position of a static point.

[3] Observables—1, 2, 3

This option determines the observables available in the receiver, where:

- 1—CA code and P-code on L1/L2 (No carrier)
- 2—CA code and carrier, P-code on L1/L2 (No carrier)
- 3—CA code and carrier, P-code on L1/L2 and carrier

[J] RTK Rover

The [J] option allows the receiver to act as a rover station that utilizes the carrier phase differential (both DBEN and RTCM message 18, 19, 20, and 21) data transmitted from the base to compute differentially corrected positions. This option requires the observables option to be 3. For RTCM messages type 18, 19, 20, and 21, the U option is required in addition to the J option.

[K] RTK Base

The [K] option allows the receiver to act as a real-time Z base station which will output carrier phase differential data. This option requires the observables option to be 3. For RTCM 18/19 or 20/21, the B option is also required.

[I] Instant RTK

The I option, an extension of the J option, allows the receiver to use the new RTK system - Instant RTK™ which uses a new data processing strategy for integer ambiguity initialization. The initialization time using Instant RTK typically requires a single epoch of data if there are 6 or more satellites available with reasonable open sky and low multipath. The baseline length should be 7 km or less.

2

Operation

This chapter describes receiver operations other than those available through the front panel.

Receiver Initialization

It is good practice to reset your receiver prior to operating it for the first time or when a system malfunction occurs. A reset of the internal memory clears the memory and restores the factory defaults. This reset does not affect data stored on the PCMCIA card. Send the following command to execute the initialization:

```
$PASHS,INI,5,5,5,5,1,0
```

For more information about this command, refer to Chapter 6, **Command/Response Formats**.

Setting Receiver Parameters

All user parameters may be set or changed by sending commands to the receiver serial port. Refer to Chapter 6, **Command/Response Formats** for more information about these commands. In the Z-Xtreme, Z-Surveyor and the Z-FX receivers, many parameters are accessible through the front panel LED display. Refer to your particular receiver operation manual for more information.

Saving Parameter Settings

Ordinarily, receiver parameters that have been changed will return to their default status after a power cycle. The Z-Family of receivers allows you to save changed receiver settings so they will be saved through a power cycle. Perform the following steps to save receiver settings:

1. Send the receiver command: \$PASHS,SAV,Y.
2. This command saves any parameters that have been modified from their default values before the command is issued. For more information about this command, refer to “SAV: Save User Parameters” on page 128.

Data Recording (Z-Xtreme, Z-Surveyor, Z-FX only)

All data recording in the receiver (those that have memory capacity) is done on the PCMCIA data card also known as a PC card. The PC card is a compact and convenient way to store a lot of data. The amount of data that can be stored depends upon the size of the card. PC cards, available in sizes ranging from 2 to 85MB, are normally factory formatted, but they must be formatted by the receiver using the \$PASHS,CLM command before using the card. Insert the PC card correctly in the PC card slot in the memory compartment to record data. If the receiver is tracking satellites, and the PC card is correctly inserted, data automatically record on the card.

While data is recording on the PC card, a LED inside the PC card compartment will flash red, indicating that the PC card is actively in use. Do not remove the PC card while the card is actively in use. Loss of data and possible card corruption may result. If you need to remove the card for any reason while recording data, use the STOP SESSION function in the SESSIONS menu of the display. This will stop data recording so the card may be removed and the same or a new card inserted. Data recording will resume as soon as the card is inserted. If for any reason data recording does not resume or if the card was not removed, use the START SESSION function in the SESSIONS menu of the display. The stop session and start session functions can also be achieved with the serial port commands \$PASHS,REC,S and \$PASHS,REC,R, respectively.

Setting the Data Recording Interval

The default recording interval is 20.0 seconds, an interval adequate for many static surveying operations. Changing the recording interval is normally done via the LED display interface, using the parameter REC. INT: in the Survey Configuration (SurvConf) menu. The data recording interval can also be changed using the serial

port command \$PASHS,RCI. The \$PASHS,RCI controls both the rate of data recorded to the PCMCIA card as well as the output of raw data from the serial port.

It is also possible to set one rate of data recording for the PCMCIA card and a different rate of raw data output to the serial port. This is done using the \$PASHS,DRI and the \$PASHS,DOI commands. \$PASHS,DRI sets the PCMCIA card data recording rate. \$PASHS,DOI sets the rate of raw data output for the serial port. The default of both these commands is 20.0 seconds. Be aware that setting the \$PASHS,RCI command or changing the REC INT in the LED display will override any parameter previously set in the DRI or DOI command. For more information about serial port commands, see Chapter 6, Command/Response Formats.

PCMCIA Card

All data recording in the receiver is done on a PCMCIA data card (also known as a PC card). The PC card is a compact and convenient way to store a lot of data. The amount of data that can be stored depends upon the size of the card. PC cards are available in sizes ranging from 2 to 128 MB.

To work properly, the PCMCIA card must be formatted prior to use. Most PCMCIA cards come pre-formatted for PC compatibility (if not, use the DOS format command), but they also must be formatted by the receiver itself. **It is also strongly recommended that the PCMCIA card be reformatted in the receiver on a consistent basis to minimize the chance for card malfunction.** Over time files on the card become fragmented and could interfere with data recording. Reformat the card at least biweekly when using the receiver regularly. See below for formatting procedures.

Data recording to the PC card is automatic, if the card is correctly installed and the receiver is tracking satellites. While data is recording on the PC card, the Memory Storage Indicator LED will flash green, indicating that the PC card is actively in use. Do not remove the PC card while the card is actively in use. Loss of data and possible card corruption may result. If you need to remove the card for any reason while recording data, use the STOP SESSION function in the SESSION menu of the LED display. This will stop data recording so the card may be removed and the same or a new card inserted. (NOTE: card removal does not apply to Z-FX receivers.) Use the START SESSION function in the SESSION of the LED display to resume recording. The stop session and start session functions can also be achieved with the serial port commands \$PASHS,REC,S and \$PASHS,REC,R respectively. See the Operations and Reference manual for more information about PCMCIA card removal and installation, and the LED display.

In addition, be aware that the receiver uses a file system mounting procedure that creates a backup of the file allocation table. Upon power up, the receiver will

compare the backup table with the table on the disk, if there is a discrepancy, the table is rebuilt. This may take about 40 seconds for a 16 MB card and 2-3 minutes for a 85 MB card. During this time, the receiver's file system is inaccessible. However, the status of the file mounting progress may be monitored through the serial port using the \$PASHS,FSS command. The file mounting will happen occasionally during routine power up, and will always happen if a different PC card is inserted, or during a receiver initialization or \$PASHS,CLM command that reformats the PC card.

Formatting the PC Card

PCMCIA cards are typically factory formatted for PC compatibility. If the PC card is not formatted, format it with the PCMCIA drive in the PC using the DOS format command.

Prior to use in the receiver, the PCMCIA card must also be receiver formatted, and should be reformatted on a regular basis. PC cards should be reformatted biweekly for receivers in continual use. Regular reformatting prevents file fragmentation on the card that could cause data problems.

The PCMCIA card can be formatted in one of the following two methods. However, prior to first use, the \$PASHS,CLM method should always be used.

- Issue the serial command \$PASHS,CLM which formats all tracks in the PC card one by one, including the FAT (file allocation table), the directory, and the data area. This process requires approximately 7-8 seconds per MB, including both the reformatting and the file system mounting time. This is the optimum and recommended method.
- Issue the serial command \$PASHS,FIL,D,999 or select the DELETE ALL option in the SESSION menu on the front panel LED display. Both of these techniques format only the FAT and the directory area in the PC

card, and does not physically clear the data area. This process takes just a few seconds to complete, regardless of PC card size.

PCMCIA File Structure

The receiver stores files in the root directory and creates a single file per session. Sessions are created after

- Cycling the receiver power
- Selecting the NEW SESSION option in the SESSIONS menu of the front panel display
- Issuing the \$PASHS,FIL,C command
- Selecting the STOP/START option in the SESSIONS menu of the front panel display
- Issuing the \$PASHS,REC,S/R command

Although the receiver is capable of creating a number of different records that cover a wide variety of information, the session file, U-file, contains all available type of data records (almanac records, ephemeris records, raw data records, position records, site information records, site attribute records, event marker records). The U-file decodes into different files during the download process (see "Downloading the Data" on page 13 for more information).

The files are automatically named according to a naming convention that includes the site name, session, and day of the year. Figure 2.1 outlines the file naming convention. The one exception are almanac files that are named ALMyy.ddd where yy are the last two digits of the year and ddd is the day of the year.

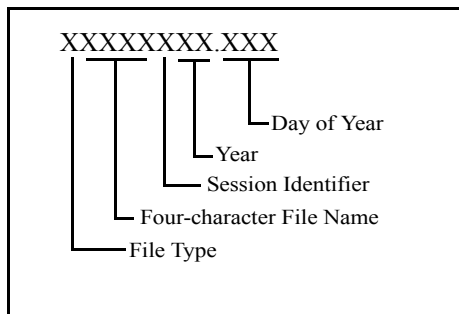

Figure 2.1. File Naming Convention

- The first letter is the file type (in this case always U).
- The next 4 characters indicate the SITE information. If the user has not entered a SITE, then these 4 characters are replaced by underscores("_____"). If the user has not entered a SITE during the course

of the session, the last SITE information entered in the previous session is used. If the SITE has been entered several times during the course of the session, the last entered SITE information is used.

- The next character is the session identifier. This field automatically increments from A to Z, with each new session. After 26 sessions are created, the session identifier resets back to A and the first character of the year changes to A. Then, once again the session identifier increments from A to Z with each new session.
- The next two characters indicate the last two digits of the year when the session was terminated (e.g. 99).
- The file extension indicates the day of the year when the session was terminated (e.g. Jan. 1 is day 001; Dec. 31 is day 365).

Data Modes

The receiver can record data in three different modes, called data modes or data types. Each mode records different combination of data records and can only be changed using the serial port command \$PASHS,RNG. Table 2.1 describes these modes. The default is mode 0.

Table 2.1. Recording Modes

Recording Mode	Typical Application	Records Created	File Type After Conversion
0	Raw data, full code and carrier phase	Raw data	B-file
		Ephemeris	E-file
		Session information	S-file
		Almanac	ALMyy.ddd
2	Position data only	Position	C-file
		Session	S-file
		Almanac	ALMyy.ddd
4	Raw data, full code and carrier phase, position data file	Raw data	B-file
		Position	C-file
		Ephemeris	E-file
		Session information	S-file
		Almanac	ALMyy.ddd

Downloading the Data

The data on the PC card can be either downloaded from the receiver via the serial port or read from the PCMCIA drive into the PC. In both cases, use the **Download** application. **Download** handles the protocol required to transfer data from the receiver via the serial port into the PC memory.

When transferring PC data from the receiver or the PCMCIA drive into the PC, **Download** reads the U-files records from the PC card and converts them into different data files, creating one set of data files per each session. Data files are named using the U-file name for that session, however the first letter corresponds to the file type. The one exception are almanac files which are named ALMyy.ddd where YY are the last two digits of the year and ddd is the day of the year. Table 2.2 lists the file types.

Table 2.2. File Types

File Type	Generated From	Format
B-file	Raw data - generally code and carrier phase, position, and SITE data	Binary
E-file	Satellite ephemeris data	Binary
S-file	Site information data	ASCII
C-file	Position data	ASCII
M-file	Event marker files (photogrammetry)	ASCII
D-file	Site attribute files	ASCII
ALMyy.ddd	Almanac data	Binary

Data Logging through Serial Port

An alternative way to record data is to record data directly onto your PC. This method is useful if your data card does not have enough space or if you wish to bypass the download process. To record data directly onto the PC, use the DATALOGR.EXE program. DATALOGR will collect B and E-files in real time onto your computer.



Data logging through a serial port is also possible with Z-Sensor and Z-Eurocard.

Elevation Masks

Because data from GPS satellites near the horizon are often excessively noisy and can degrade position computation and post-processing, GPS receivers use elevation masks to filter out the unwanted signals. The receiver has 2 main

elevation masks, a data elevation mask and a position elevation mask. Data for satellites below the data recording elevation mask will not be recorded or output. Satellite data below the position elevation mask will not be used for position computation.

The default for both the data elevation mask and the position elevation mask is 10 degrees. The data elevation mask may be changed using the \$PASHS,ELM command. The position elevation mask may be changed using the \$PASHS,PEM command. For receivers with an LED display, the data elevation mask may also be changed in the Survey Configuration (SurvConf) menu setting the ELEV MASK: parameter.

Secondary Elevation Mask

In some cases, noisy atmospheric conditions may exist at higher elevations only in a certain sector of the sky, interfering with satellite data in that part so that position quality is degraded. For example, ionospheric activity may be especially active to the north, affecting all satellites in that quadrant. To correct this problem, a secondary elevation mask has been created. This secondary elevation mask is set using the command \$PASHS,SEM. The parameters for the \$PASHS,SEM include a first and a second azimuth that are used to define the part of the sky to be masked, and an elevation mask value that applies only to the area within those azimuth values (Figure 2.2). Note that the \$PASHS,SEM command only applies to position computation and does not affect data recording or output.

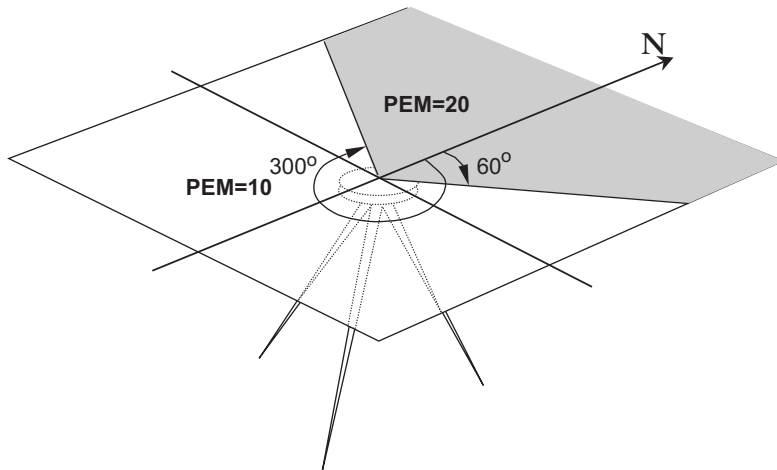

Figure 2.2. Secondary Elevation Mask (SEM) Zone

Zenith Elevation Mask

Towers or other heavy metal equipment that are directly over the GPS antenna may cause intermittent data collection and areas of extreme multipath at very high elevation angles, creating poor quality data from certain satellites and degrading position computation. To remove these satellites, a zenith elevation mask has been created. Whereas the normal elevation mask disregards satellites between the horizon and the mask angle, the zenith elevation mask ignores satellites between the mask angle and the zenith (90°), as shown in Figure 2.3. Rather than create a separate command, an additional, optional zenith elevation mask parameter has been added to the \$PASHS,ELM data elevation mask and the \$PASHS,PEM position elevation mask commands.

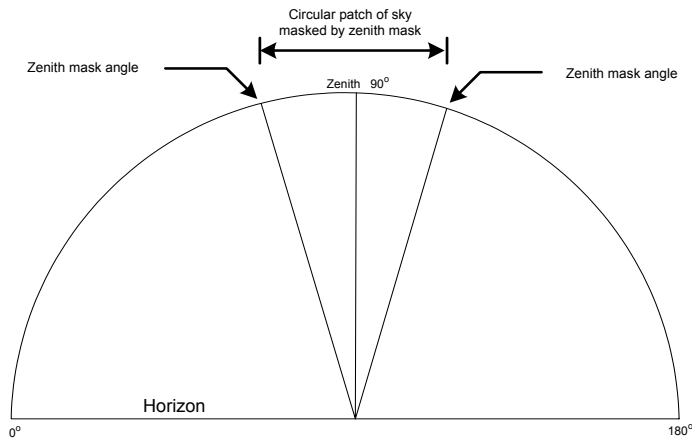

Figure 2.3. ZEN (Zenith) Elevation Mask Zone

Session Programming

The Session Programming feature allows you to pre-set up to 26 observation sessions in the receiver. The receiver can then run unattended and will collect data on the data card only during the times that have been preset. Once set, the sessions will collect data during the preset session times every day. Or if desired, a session time offset can be programmed in that will shift the session start and end times by a set amount every day.

Session programming can also be used to put the receiver into sleep mode. When the receiver is in sleep mode, most of the receiver functions are shut down which will conserve power when data is not being collected. Using the session start

times that have been preset, the receiver will automatically wake up in time to collect data for the next session and go back to sleep when the session is over.

Session programming is enabled by using either *Receiver Communications Software* or the REMOTE.exe program, with either the <ALT-P> option, or else by sending the \$PASHS,SES commands through the serial port. Regardless of which method is used, you will need to enable the individual sessions and set session parameters such as the desired start/stop time, the recording interval, elevation mask, minimum number of satellites, and the data type for each session to be recorded.

In addition, you will need to set the mode (session in use switch), the session reference day, and any desired session offset. The mode is either Yes, No, or Sleep. If the mode is NO, then session programming is not enabled, even if individual session are set. If the mode is Yes, then session programming is enabled, and any enabled individual sessions will be activated. If the mode is Sleep, then the receiver will go into sleep mode once an activated session is completed, and will wake up just prior to the next session.

The session reference day is a mandatory parameter that both determines the start day of session programming data collection and is used in conjunction with the Offset to determine the session start and end times. The reference day must be set to equal to or earlier than the current day, or else the sessions will not run. If the reference day is later than the current day, then the session start and end times will decrement by the Offset multiplied by the numbers of days between the current day and the reference day. For example, suppose you wish to collect data every day for 7 days observing the identical satellite window on each day. Since the GPS window moves backwards 4 minutes per day, you would set the Offset to 0400 and set the reference day equal to the current day. For each subsequent day of data collection, all sessions will start and end 4 minutes earlier than the previous day. By the seventh day, the sessions will start and end 28 minutes earlier than on day 1.

If a file name with the same name and session ID as the current session programming session ID exists, new data will be appended to the end of this file.



Position Mode

The receiver performs a position fix computation in four modes. The \$PASHS,PMD command is used to select the mode. Table 2.3 describes these four modes.

Table 2.3. Position Modes

Mode	Description
0	At least four satellites with elevation equal to or above elevation mask are needed to compute a position. All three polar coordinates are computed in this mode.
1	At least three satellites with elevation equal to or above position elevation mask are needed to compute a position. Only latitude and longitude are computed if three satellites are locked and altitude is held. If more than three satellites are locked, this mode is similar to mode 0.
2	At least three satellites with elevation equal to or above position elevation mask are needed to compute a position. Only latitude and longitude are computed, and altitude is always held, regardless of number of satellites.
3	At least three satellites with elevation equal to or above position elevation mask are needed to compute a position. Only latitude and longitude are computed, and altitude is held if only three satellites are locked. If more than three satellites are used and HDOP is less than the specified HDOP mask, all three polar components are computed. If HDOP is higher than the specified HDOP mask, receiver automatically goes into altitude hold mode.

ALT Fix Mode

Two modes define what altitude is selected when the receiver is in altitude hold mode. The \$PASHS,FIX command can be used to select between these modes.

In mode 0, the most recent altitude is used. This is either the one entered by using the \$PASHS,ALT command or the one computed when four or more satellites are used in the solution, whichever is most recent. If the last altitude is the one computed with four or more satellites, it is used only if VDOP is less than the VDOP mask.

In mode 1, only the last altitude entered is used in the position fix solution.

On initial power-up, or a receiver initialization, the most recent antenna altitude is 0.

Daisy Chain Mode

The Daisy Chain mode establishes a communication link through the GPS receiver, between a PC/handheld and a peripheral device. When the GPS receiver is in Daisy Chain mode, all commands entered in one serial port are passed back out through another serial port. The commands are not interpreted by the GPS receiver. The command \$PASHS,DSY enables the Daisy Chain mode and allows the user to assign which serial ports to be used. A typical example of the use of Daisy Chain mode is communicating with a radio through a handheld. The radio and handheld are not directly connected but are both connected to the GPS receiver via separate serial ports. By enabling the Daisy Chain mode between the two serial ports used by the handheld and radio, the handheld can communicate with the radio through the GPS receiver. Refer to “DSY: Daisy Chain” on page 95.

Point Positioning

The Point Positioning option improves the accuracy of a stand-alone absolute position of a stationary receiver from about 50 meters to less than five meters over a period of four hours, and can typically get down to a couple meters level after ten hours. Point positioning uses an averaging technique to reduce the effects of Selective Availability (SA) and other fluctuating errors. Point positioning mode can be set using the \$PASHS,PPO command. Refer to Chapter 6, **Command/Response Formats** for more details about this command. The Point Positioning receiver option [T] must be set in the receiver for this command to work.

Remote Monitoring

Remote monitoring allows a user to control a remotely located receiver through a PC and a modem link. You can then:

- monitor operational status
- configure receiver parameter settings
- download data

This function is useful in situations where a receiver is operating in a difficult to access location.

The receiver must have the Remote Monitor [M] option enabled. Use the REMOTE.exe software to perform remote monitoring.

Event Marker

When the Event Marker [E] option is installed, the receiver can measure and record event times with high accuracy. In order to store an event time in the receiver's memory, a trigger signal must be applied to the appropriate connector located on the rear panel of the receiver (refer to your individual receiver manual for pinout information). The event marker feature allows the event time to be stored in memory and downloaded using the DOWNLOAD program as an M-file, or output by using the \$PASHS,NME,TTT command.

At the rising or falling edge (selectable) of the trigger signal, the time is recorded in the receiver's PC card. The trigger signal can be set to the falling edge using the \$PASHS,PHE command.

The measured time is accurate down to 1 microsecond. This is GPS time (UTC + 12 seconds as of 1 July, 1997) and is recorded as the time since the start of the GPS week (00:00 a.m. Sunday). The output includes day number, hours, minutes, seconds, and fractional seconds up to seven digits. With each event time, the receiver also records the site name. One example of the record is:

TEXA 4 21:30:19:4309643

The event time is measured relative to the receiver's GPS time. It measures only the first event during the period between 2 GPS epochs (1ms). Refer to Figure 2.4. This allows use of mechanical switches without concern for contact bounces.

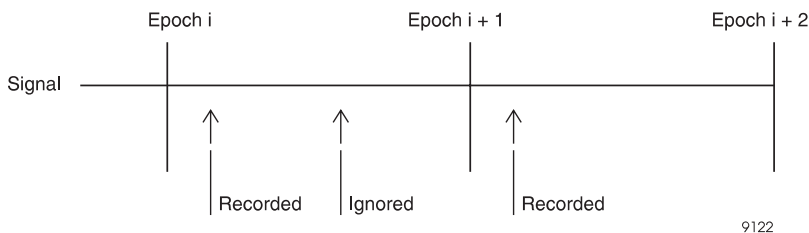

Figure 2.4. Event Marker Time Measurement

The receiver stores only one event time per nav processing cycle (0.5 sec for ZB00 and 0.1 sec for ZC00 or later). If more than one event time is measured within a data collection period, the receiver records only the first one.

The trigger pulse may be TTL-compatible or open collector. Minimum pulse duration is 100 nanoseconds when the signal is not terminated at the receiver input. The impedance is approximately 2K ohms.

Use a coaxial cable with BNC connectors to connect the camera trigger output to the photogrammetry input connector of the sensor.

Time Tagging the Shutter Signal

In this technique, the signal generated by the camera shutter is fed to a GPS unit for accurate time-tagging which can then be post-processed with the GPS observations. Since the time of the picture is not synchronized with the time that the GPS measurement is taken, the two position computations before and after the shutter time are interpolated to compute the position of the camera at the time the picture was taken.

For example, suppose the GPS measurements are recorded at the rate of one per second while the distance that the aircraft moves in $\frac{1}{2}$ second is about 100 meters. The induced error between the position of the camera at the time the picture was taken and the GPS position fixes can be as much as 50 meters. To minimize the errors discussed above, the closed loop technique is recommended.

Closed-Loop Technique (Advanced Trigger)

The closed-loop technique combines PPS synchronization and shutter timing as shown in Figure 2.5.

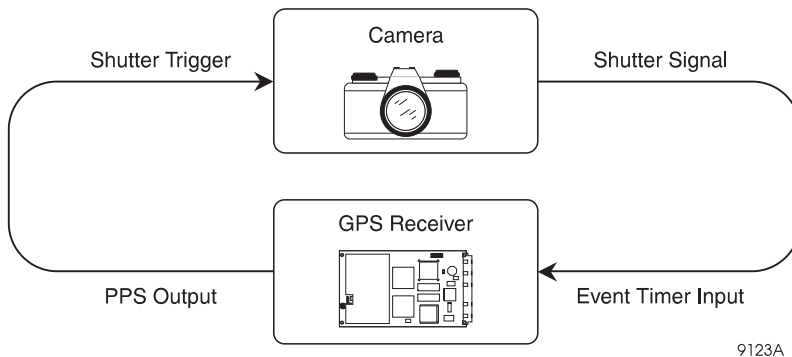

Figure 2.5. Closed Loop Technique

In this technique, the 1PPS output of the receiver triggers a camera shutter. The camera shutter generates a signal that is fed to the receiver for accurate time tagging.

The delay between the camera receiving the pulse and triggering the photogrammetry port should be calculated. This may then be applied so as to advance the 1PPS from the receiver so that the shutter time exactly matches the GPS system time for the epoch. No interpolation between the shutter time and the GPS position time will be needed.

This input is asserted by bringing it to ground with a low-impedance driver, a contact closure, or an open-collector transistor. The maximum voltage to guarantee assertion is 0.75 volts, and the current when grounded will be no more than 350 microampere.

The input has an internal pull-up, so it is not necessary to drive it high to make it inactive. The signal will be de-bounced internally, so only the first falling edge in a pulse train of up to 100 milliseconds will be detected.

1PPS Out

By default, the receiver generates a TTL-level pulse every second within one microsecond of the GPS time for synchronization of external equipment. Refer to your individual receiver manual to determine signal location on the pinouts of the ports. This pulse can be offset using the \$PASHS,PPS command (refer to “PPS: Pulse Per Second” on page 122). It can also synchronize either the rising edge (default) or the falling edge to the GPS time. The receiver can generate this signal with a different period (0.1 to 60 seconds). Setting the period to 0 disables the PPS pulse.

You may output the time tag of the pulse to a serial port via the \$PASHS,NME,PTT,c,ON (where c is the output port). This message will be sent within 100ms of the pulse. It has been designed to minimize the latency when the offset is 0.0 (within 30ms of the pulse when Fast CPD is off).

This output is driven by a 3.3 volt CMOS gate through a 150 ohm resistor, and is intended to drive a high-impedance TTL or CMOS input. The minimum allowable input resistance to guarantee TTL input levels is 250 ohms.

Data Output

Real time data output is only available through the four RS-232 ports. Refer to Chapter 6 for more details. There are two types of messages:

- NMEA

NMEA is a standard data transfer format developed to permit ready and satisfactory data communication between electronic marine instruments, navigation equipment and communications equipment when interconnected via an appropriate system. This is data in printable ASCII form and may include information such as position, speed, depth, frequency allocation, etc. Typical messages might be 20 to a maximum of 79 characters in length and generally require transmission no more often than once per second.



Due to the extra resolution required for RTK operation, some NMEA messages are actually longer than the specified 80 characters.

- Proprietary

When specific information was needed, and the NMEA standard did not contain a suitable message, Ashtech created proprietary messages.

Messages are available in ASCII.

With the Fast Data output [F] option installed, the highest output rate supported is 10Hz. This is valid for every setting except for RTK Differential mode, if Fast CPD mode is set to off, in which case the highest rate is 1 Hz (if Fast CPD mode is on, 10 HZ is available). Also, if the [F] option is not installed, the highest output rate supported is 5Hz.

Transferring Data Files

GPS data stored on the PC Card may be transferred to a computer for post-processing by three different methods using **Download**. **Download** reads the session file (U-file), converts the file into the different data files (B-, C-, D-, E-, M-, S-, and almanac files), and transfers the converted files to the specified directory.

- Download data directly through one of the receiver serial ports into any directory on the computer.
- Load the PCMCIA card into a PCMCIA drive and download the data to any directory on the computer.
- Load the PCMCIA card into a PCMCIA drive in your computer, and copy the file **MICRO_Z.BIN** to your hard disk. Then use **Download** to convert the file into usable data files.



The U-file is a compressed file format and is not usable until converted using **Download**.

For more information on using **Download**, refer to the *Receiver Communication Software User's Guide*.

Synchronization to GPS Time

All GPS receivers contain internal clocks. These clocks are of varying quality, and for cost reasons, are not generally accurate enough to be precisely synchronized to GPS system time (or “true GPS time”). The effect of receiver clock error shows up in two places. First, it affects the instant in time when measurement snapshots

are taken, and second, it introduces errors in the values of the measurements themselves. This means that two receivers at the same location (zero-baseline), but with different clock errors, will, among other things, provide different position measurements. Similarly, if two receivers are moving together, their position measurements would be different, because each receiver will report a position for a snapshot taken at a different time.

Fortunately, if a receiver obtains measurements from four or more satellites it can determine its own internal clock error. In order to reduce the effects mentioned previously, most receivers use the computed clock error to periodically reset the internal receiver clock to remain close to GPS system time (within a millisecond). This method does not entirely remove the effects mentioned above and furthermore causes jumps in the raw measurements obtained by the receiver; all of which the user must account for when processing the data.

The receiver offers a GPS Time Sync Mode, which almost completely removes the effects of the receiver clock error. For example, the jumps in the raw measurements do not appear in GPS Time Sync Mode, and also in zero baseline tests, two Ashtech receivers in GPS Time Sync Mode will provide very closely matching pseudo-range measurements.

Default Parameters

During the normal course of receiver operation, a typical user will often change one or more receiver parameters such as recording interval, port baud rate, or elevation mask. To save new settings, the user must save the current setting to memory or else all parameters (with a few exceptions) will be reset to the default values during a power cycle. The exceptions are session programming parameters, modem setting parameters, MET (meteorological) and TLT (tilt) parameters, and the POW (power) parameters. Saving parameters to memory can be done in two ways; either by enabling the SAVE option in the SETTINGS menu of the LED interface (only for the Z-Xtreme, Z-Surveyor and Z-FX), or by issuing a \$PASHS,SAV,Y command to the serial port. When parameters are saved to the memory, they are maintained until a memory reset or a receiver initialization is performed which will reset all parameters back to their default.



Only the parameters modified prior to issuing the SAV command are saved in memory. Any parameter modified after SAV is issued reverts to default after power cycle.

The following table lists the default values of all user parameters.

Table 2.4. Default Values

Parameter	Description	Default
SVS	Satellite Tracking Selection	Y for all
PMD	Position Mode Selection	0
FIX	Altitude Hold Fix Mode Selection	0
PEM	Position Elevation Mask	10
ZEN_PEM	Zenith position elevation mask	90
FUM	Use of UTM Coordinates	N
FZN	UTM Zone Selection	01
PDP	Position Dilution of Precision Mask	40
HPD	Horizontal Dilution of Precision Mask	04
VDP	Vertical Dilution of Precision Mask	04
UNH	Use of Unhealthy Satellite's	N
ION	Enable Ionosphere Model	N
PPO	Enable point Positioning Mode	N
SAV	Save parameters in Battery Backup Memory	N
ANR	Antenna Noise Reduction	CPD
LAT	Antenna Latitude	00N
LON	Antenna Longitude	00W
ALT	Antenna Altitude	+00000.000
DTM	Datum Selection	W84
UDD	Datum Users Defined Parameters	Semi Mayor Axis = 6378137.000 Inverse Flattening = 298.257224 Remaining parameters = 0
HGT	Height Model Selection	ELG
GRD	Datum to Grid Transformation Selection	NON
PHE	Photogrammetry Edge Selection	R
PPS	Pulse per Second Default Parameters	Period = 1 second Offset = 000.0000 Edge = R
POW parameters	Power Capacity of External Battery	ALL 0'S

Table 2.4. Default Values (continued)

Parameter	Description	Default
Session Programming	Session Programming Default Parameters	INUSE flag = N REF day = 000 OFFSET = 00:00 For all Sessions: Session Flag = N Start Time = 00:00:00 End Time = 00:00:00 RCI = 20 MSV = 3 ELM = 10 RNG = 0
MDM	Modem Parameters	MODE=OFF TYPE = 0 (US Robotics) PORT = B BAUD RATE = 38400
BEEP	LED display and warning beep	On (Remote User's Guide and Z-FX) Off (Z-Sensor)
CTS	Clear to send port setting	On
LPS	Loop parameter setting	01, 2, 3
MET	meteorological parameter setting	All ports off INIT-STR:No TRIG-CMD:*0100P9 INTVL:5
TLT	Tilt Meter parameter setting	All ports OFF INIT-STR:No TRIG-CMD:*0100XY INTVL:1
NMEA messages	NMEA Message Output Status	OFF in all ports
TAG	NMEA Message Format	ASH
PER	NMEA Messages Output Rate	001.0
RCI	Raw Data Output Rate/Recording Rate	020.0
DOI	Data Output Interval	20
DRI	Data Recording Interval	20
MSV	Minimum Number of Satellite's for Data Recording/Output	03
ELM	Elevation Mask for Data Recording/Output	10
ZEN_ELM	Zenith Elevation Mask	90
REC	Record Data Flag	Y

Table 2.4. Default Values (continued)

Parameter	Description	Default
MST	Minimum Number of Satellite's for Kinematic Operation	0
ANH	Antenna Height (before session)	00.0000
ANA	Antenna Height (after session)	00.0000
SIT	Site ID Name	????
EPG	Kinematic Epoch Counter	000
RNG	Ranger Mode Selection	0
RAW data	Raw Data Output Status	OFF in all ports
Raw data format	Raw Data Output Format	ASCII in all ports
Serial Port Baud Rate	Serial Ports Baud Rate Selection	9600 in all ports
RTCM MODE	RTCM Differential Mode Selection	OFF
RTCM PORT	RTCM Differential Mode Port Selection	A
AUT	Automatic Differential/Autonomous Switching when RTCM Differential Mode Enabled	N
RTCM SPD	RTCM Differential BPS Speed Setting	0300
STI	RTCM Base or Remote Station ID Setting	0000
STH	RTCM Base Station Health Setting	0
MAX	Maximum Age for old RTCM Corrections to be Used	0060
QAF	RTCM Communication Quality Setting	100
SEQ	Use Sequence Number of RTCM Correction in Remote Station	N
TYPE	RTCM differential Messages Enabled and Output Frequency of the Enabled Messages	1 = 99, 6 = ON Remaining messages 00
RTCM EOT	End of Character Selection for RTCM Corrections	CRLF
MSG	Text for RTCM type 16 message	empty
IOD	IODE Update Rate	30
CPD MODE	CPD Mode Selection	Disabled
PED	DBEN Output Transmission Period	001.0

Table 2.4. Default Values (continued)

Parameter	Description	Default
DBEN PORT	Output Port For DBEN messages in the Base	B
CPD EOT	End of Character Selection for CPD Corrections	CRLF
AFP	Setting of Ambiguity Fixing Confidence Level	099.0
MAX AGE	Maximum age of corrections for CPD	30
DYN	CPD Rover Mode Dynamic Operation	WALKING
MTP	Level of multipath Selection	MEDIUM
CPD POS	Reference Position of the other Receiver	RECEIVED
FST	Fast CPD Mode Selection	ON
CPD PER	CPD Update Interval	01
ANT radius	Radius of the Antenna	0.0000
ANT offset	Distance from Antenna Phase Center to Antenna Edge	00.0000
ANT horizontal azimuth	Azimuth measured from Reference Point to Antenna Phase Center	00000.00
ANT horizontal distance	Distance from Reference Point to Antenna Phase Center	00.0000

Multipath Mitigation

Multipath occurs when GPS signals arrive at the receiver after being reflected off some object. The reflected signals always travel a longer path length than the direct signal. This leads to measurement errors in the receiver which is trying to measure the direct path length to the satellite. The techniques for rejecting the reflected signals are known as multipath mitigation.

The receiver implements the latest advances in Ashtech Multipath Rejection Technology: the Enhanced Strobe Correlator™.

This correlator drastically improves multipath mitigation over the traditional correlator schemes such as standard (1-chip) correlator spacing or narrow (1/10 chip) correlator spacing.

The Enhanced Strobe Correlator™ works well in any kind of multipath environment, specular as well as diffuse, regardless of the number of multipath signals present, its ability to track is not significantly impacted in low SNR

environment and it does not give away other receiver performance, such as noise performance.

A detailed description of Enhanced Strobe Correlation performance is given in “*Enhanced Strobe Correlator Multipath Rejection for Code & Carrier*”, Lionel Garin, Jean-Michel Rousseau, Proceedings of ION-GPS'97 Sept. 16-19 1997, Kansas City, Missouri.

Evaluating Correlator Performance

Theoretical analysis of the different multipath mitigation techniques is a straightforward analysis of how much error hypothetical multipath signals would cause. A plot of multipath mitigation performance is made by assuming a reflected signal with a certain power (usually half the power of the direct signal) and a certain delay. The induced error on the range measurement is then calculated and plotted. Figure 2.6 shows the error envelopes induced by a multipath signal half the strength of the direct signal, for the Standard Correlator, the very well known Narrow Correlator and the new Ashtech Enhanced Strobe Correlator. The x-axis shows the multipath delay, which is the extra distance that the reflected signal travels compared to the direct signal. The y-axis shows the induced range error caused by a multipath signal with the indicated delay. As the multipath delay increases, the error oscillates between the positive and negative error envelope.

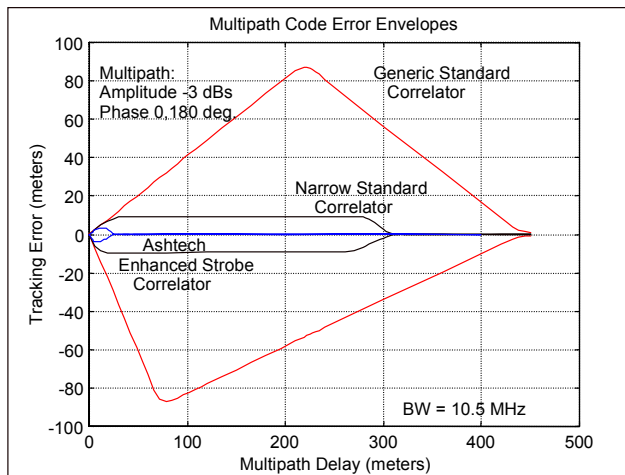

Figure 2.6. Relative Performance of Multipath Mitigation Techniques

In a real situation, multipath is usually a combination of many reflections, all with different delays and different power. Real-life multipath is often described as either close-in multipath or far multipath. Close-in multipath occurs when the reflecting surface is close to the satellite antenna direct line, and the delay is small; usually, these reflections come from a surface near the antenna, for example, an antenna on a tripod on the ground would pick up close-in multipath from reflections off the ground below and around the tripod.

Figure 2.7 is a blow up of Figure 2.6 and shows that Enhanced Strobe Correlation techniques prove much better than usual techniques, especially for close-in multipath that is attenuated by a factor of 3. Very close-in multipath causes only a small change in the ideal correlation function, so it is usually almost impossible for the correlator-base multipath integration to completely compensate for this error.

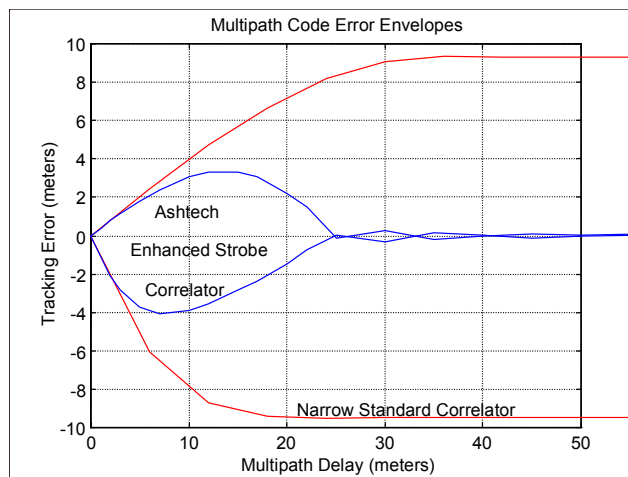

Figure 2.7. Detailed View of Multipath Mitigation Performance

In order to completely compensate for close-in multipath, we suggest to use Choke-ring antennas along with the Enhanced Strobe Correlation technique.

Far multipath can cause very large errors if a good multipath mitigation technique is not used.

Far multipath occurs when there is a reflecting surface at some distance from the antenna, such as a building, a mast, a mountain, etc. Metal surfaces cause the strongest reflections. Far multipath signals can be very nearly eliminated by good correlator-based multipath mitigation techniques.

Signal-to-Noise Ratio

The signal-to-noise ratio or C/No as given by the receiver is the ratio of the total signal power to the noise power in a 1 Hz bandwidth otherwise known as the carrier-to-noise ratio or C/No. The reference point of the reading is the antenna connector located on the receiver's back panel. It is expressed in units of dB.Hz. It is important to realize that the displayed C/No includes the degradation caused by many factors before reaching the receiver, including: antenna gain, antenna temperature, and LNA noise figure. The C/No at the output of the antenna element will be degraded by the noise produced by the first amplifier, known as the low-noise amplifier (LNA) which is built into most Ashtech antenna assemblies. When using different antennas with the receiver it should be noted that differences in C/No can be seen as a result of the above mentioned factors. If calibrating the C/No reading of the receiver with a satellite constellation simulator at room temperature, realize that the noise figure of the LNA will degrade the C/No reading by the amount equal to the noise figure of the LNA.

$$(C/No)_{\text{reading}} = (C/No)_{\text{simulator}} - NF$$

where:

- NF is the preamplifier Noise Figure in dBs,
- (C/No)reading is the carrier-to-noise ratio displayed by the receiver in dB.Hz,
- (C/No)simulator is the carrier-to-noise ratio at the output of the GPS simulator in dBHz.

 If you select to display C/No for the C/A code (or C/No for P1 code), the displayed figure relates to the ratio of the power of the C/A code only (or P1 code only) to the noise power in a 1Hz bandwidth.

Antenna Reduction

Unless requested by the user, the position solution provided by a receiver is the one of the antenna phase center. The receiver provides a means of obtaining the position of the surveyed point rather than the antenna phase center through two commands: \$PASHS,ANT and \$PASHS,ANR.

The ANT command allows the user to specify the antenna parameters (such as the distance between the antenna phase center and the surveyed point). Since the antenna phase center cannot be accurately accessed, this distance can be entered as antenna radius (distance between phase center and the side of the ground plate) and antenna slant (distance between the side of the ground plate and the surveyed point). The receiver will compute antenna height based on these two parameters.

The antenna radius is usually provided by the antenna manufacturer while the antenna slant can be obtained with a measuring rod.

Once these parameters are entered, the user can select to use them through the \$PASHS,ANR,x command with x indicating the following:

where x is N—no antenna reduction is performed. The solution provided is the antenna phase center.

where x is Y—Antenna reduction is performed. The solution provided is the surveyed point (if no antenna parameters were entered, the solution will be the antenna phase center)

where x is CPD—Antenna reduction is performed only for the CPD solution, not for the stand-alone or RTCM code phase differential.

Differential and RTK Operations

Real-time differential positioning involves a reference (base) station receiver computing the satellite range corrections and transmitting them to the remote stations. The reference station transmits the corrections in real time to the remote receivers via a telemetry link. Remote receivers apply the corrections to their measured ranges, using the corrected ranges to compute their position.

RTK (Real-time kinematic) positioning can be used in lieu of real-time differential positioning. RTK uses the carrier signal in addition to the code signal and is much more accurate. Although messages transmitted and calculations performed vary, RTK is essentially a special form of differential positioning. A base station receiver is required to transmit RTK data to remote receivers. The remote receivers use the RTK data to compute a corrected position.

As stand-alone, the receiver can compute a position to around 100 meters. Differential GPS achieves sub-meter precision at a remote receiver, and RTK positioning achieves centimeter accuracy at a remote receiver.

A communication link must exist between the base and remote receivers. The communication link can be a radio link, telephone line, cellular phone, communications satellite link, or any other medium that can transfer digital data.



RTK is also referred to as Carrier Phase Differential (CPD) in this manual.

Base Stations

Setting Up a Differential Base Station

You must have the Base option [B] installed on the receiver.

Send the commands listed in Table 3.1 to the receiver to generate RTCM differential corrections using message type 1.

Table 3.1. Differential Base Station Commands

Command	Description
\$PASHS,RST	Reset the receiver to factory defaults
\$PASHS,PEM,4	Set the base differential mask to four degrees
\$PASHS,POS,ddmm.mmm,d,dddmm.mmm,d,saaaaa.aa	Enter the phase center of the antenna if ANR is OFF or CPD, or the ground mark if ANR is ON.
\$PASHS,RTC,BAS,x	Turn on RTCM corrections on port x When this command is sent, a base station automatically sends RTCM message type 1 continuously.
\$PASHS,RTC,SPD,9	Set internal bit-rate for corrections to burst mode.
\$PASHS,SAV,Y	Save settings



Do not try to transmit corrections on the same receiver serial port you are using to set up the receiver from your PC.

The receiver is set as a base station which transmits RTCM message type 1 continuously. Following a power cycle the receiver automatically starts transmitting these corrections again (because you have saved the settings with the \$PASHS,SAV,Y command). To change the message type or rate, use the \$PASHS,RTC,TYP command.

Setting Up an RTK Base Station

An RTK base station supports three different types of messages:

- RTCM standard 18 & 19 (plus 3 & 22)
- RTCM standard 20 & 21 (plus 3 & 22)
- Ashtech standard DBN

RTCM 18 & 19

You must have both **[B]** and **[K]** options installed on the receiver.

Send the commands listed in Table 3.2 to the receiver to generate RTCM RTK message types 3,18,19 and 22.

Table 3.2. RTK Base Station Commands - Types 18 and 19

Command	Description
\$PASHS,RST	Reset the receiver to factory defaults
\$PASHS,ELM,9	Set the RTK Base mask to nine degrees
\$PASHS,POS,ddmm.mmm,d,dddmm.mmm,d,saaaaa.aa	Enter the phase center of the antenna if ANR is OFF or the ground mark if ANR is ON or CPD.
\$PASHS,RTC,BAS,B	Turn on RTCM corrections on port B. When this command is sent, a base station automatically sends RTCM message type 1 continuously.
\$PASHS,RTC,TYP,1,0	Turn off RTCM message type 1.
\$PASHS,RTC,TYP,3,1	Turn on RTCM message type 3.
\$PASHS,RTC,TYP,18,1	Turn on RTCM message type 18 & 19.
\$PASHS,RTC,TYP,22,1	Turn on RTCM message type 22.
\$PASHS,RTC,SPD,9	Set internal bit-rate for corrections to burst mode.
\$PASHS,SAV,Y	Save settings

The receiver is set as a base station which transmits RTCM messages types 18 and 19 every second, and types 3 and 22 every minute. Following a power cycle, the receiver automatically starts transmitting these messages again (because you have saved the settings with the \$PASHS,SAV,Y command). To change the message type or rate, use the \$PASHS,RTC,TYP command.

RTCM 20 & 21

You must have both **[B]** and **[K]** options installed on the receiver.

Send the commands listed in Table 3.3 to the receiver to generate RTCM RTK message types 3,20, 21, and 22.

Table 3.3. RTK Base Station Commands - Types 20 and 21

Command	Description
\$PASHS,RST	Reset the receiver to factory defaults
\$PASHS,ELM,9	Set the RTK Base mask to nine degrees
\$PASHS,POS,ddmm.mmm,d,dddmm.mmm,d,saaaaa.aa	Enter the phase center of the antenna if ANR is OFF or the ground mark if ANR is ON or CPD.

Table 3.3. RTK Base Station Commands - Types 20 and 21 (continued)

Command	Description
\$PASHS,RTC,BAS,B	Turn on RTCM corrections on port B. When this command is sent, a base station automatically sends RTCM message type 1 continuously.
\$PASHS,RTC,TYP,1,0	Turn off RTCM message type 1.
\$PASHS,RTC,TYP,3,1	Turn on RTCM message type 3.
\$PASHS,RTC,TYP,20,1	Turn on RTCM message type 20 & 21.
\$PASHS,RTC,TYP,22,1	Turn on RTCM message type 22.
\$PASHS,RTC,SPD,9	Set internal bit-rate for corrections to burst mode.
\$PASHS,SAV,Y	Save settings

The receiver is set as a base station which transmits RTCM messages types 20 and 21 every second, and types 3 and 22 every minute. Following a power cycle it will automatically start transmitting these messages again (because you have saved the settings with the \$PASHS,SAV,Y command). To change the message type or rate, use the \$PASHS,RTC,TYP command.

Ashtech DBEN Format

You must have the [K] option installed on the receiver.

Send the commands listed in Table 3.4 to the receiver to generate the Ashtech DBN message.

Table 3.4. RTK Base Station Commands - DBEN

Command	Description
\$PASHS,RST	Reset the receiver to factory defaults
\$PASHS,ELM,9	Set the RTK Base mask to nine degrees
\$PASHS,POS,ddmm.mmm,d,dddmm.mmm,d,saaaaa.aa	Enter the phase center of the antenna if ANR is OFF or the ground mark if ANR is ON or CPD.
\$PASHS,CPD,MOD,BAS	Set the receiver as an RTK base station with Ashtech DBN message generated once per second.
\$PASHS,CPD,PRT,B	Send DBN message through port B.
\$PASHS,SAV,Y	Save settings

The receiver is set as a base station which transmits DBN messages every second. Following a power cycle it will automatically start transmitting these

messages again (because you have saved the settings with the \$PASHS,SAV,Y command). To change the message rate, use the \$PASHS,CPD,PED command.

The receiver also transmits a BPS message (base position) every 30 seconds by default (the periodicity can be set with the \$PASHS,CPD,PEB command).



DBN messages are shorter than their RTCM equivalent, so they provide lower latency. If the data link is not very reliable, use RTCM messages because they can be used partially, unlike DBN messages, so in that configuration, the chances of obtaining a reasonable position solution are higher with RTCM than with DBN.

CMR Format

You must have the [K] option installed in the receiver.

Send the commands listed in Table 3.5 to the receiver to generate the CMR (compact measurement record) format message.

Table 3.5. RTK Base Station Commands - CMR Format

Command	Description
\$PASHS,RST	Reset receiver to factory defaults
\$PASHS,ELM,9	Set base elevation mask to 9 degrees
\$PASHS,POS,ddmm.mmmm,d,dddmm.mmmm,d,saaaa.aa	Enter the latitude, longitude, and height of the survey mark. (NOTE: If this is the position of the antenna phase center, set \$PASHS,ANR to OFF.)
\$PASHS,CPD,MOD,BAS	Set receiver as an RTK base station
\$PASHS,CPD,PRO,CMR	Set receiver to transmit CMR format data
\$PASHS,CPD,PRT,B	Send CMR messages through port B
\$PASHS,SAV,Y	Save settings to memory

The receiver is now set as a base station which transmits CMR messages every second. Following a power cycle, the receiver will automatically start transmitting these messages again (because you saved the settings with the \$PASHS,SAV,Y command).

The receiver also transmits a CMR base position message every 30 seconds by default. This rate can be changed with the \$PASHS,CPD,PEB command.

Setting Up a Combined Differential & RTK Base Station

You must have both the [B] and [K] installed in your receiver.

Send the commands listed in Table 3.6 to the receiver.

Table 3.6. Base Station Commands - Combined Differential and RTK

Command	Description
\$PASHS,RST	Reset the receiver to factory defaults
\$PASHS,PEM,4	Set the Base differential mask to four degrees
\$PASHS,ELM,9	Set the RTK base elevation mask to nine degrees
\$PASHS,POS,ddmm.mmm,d, dddmm.mmm,d,saaaaa.aa	Enter the phase center of the antenna if ANR is OFF or the ground mark if ANR is ON. Do not set ANR to CPD in this case.
\$PASHS,RTC,BAS,x	Turn on RTCM corrections on port x
\$PASHS,RTC,SPD,9	Set internal bit-rate for corrections to burst mode
\$PASHS,RTC,TYP,1,1 \$PASHS,RTC,TYP,3,1 \$PASHS,RTC,TYP,22,1	Turn on type 1 message differential correction message once per second Turn on base station position messages 3 & 22 once per minute
\$PASHS,RTC,TYP,18,1	Turn on Code and Carrier phase messages, once per second
\$PASHS,SAV,Y	Save settings

 **Type 1 is on continuously by default.**

The receiver is set as a base station which transmits RTCM Differential corrections (type 1) every second, RTCM messages types 18 and 19 every second, and types 3 and 22 every minute. Following a power cycle it automatically starts transmitting these messages again (because you have saved the settings with the \$PASHS,SAV,Y command). You can also set up the Base Station to use messages 20 & 21 instead of 18 & 19. You can not use DBN and RTCM messages on the same serial port. You can generate DBN from one port while generating RTCM from a different port.

Advanced Base Station Operation

Recommended Advanced Parameter Settings for Base Stations

Many parameters control the operation of the receiver. Leave most at the default values, except for the settings identified in Table 3.1 through Table 3.6.

Antenna

Locate the antenna with a clear view of the sky.

The antenna position, entered with the \$PASHS,POS command, is the WGS84 phase center of the antenna if the antenna reduction mode (ANR) is OFF. It is the ground mark position if ANR is ON (or CPD if the receiver is set as CPD base). Do not use ANR = CPD when setting up a combined Differential and RTK base since the position entered is interpreted differently (for more information, see “Antenna Reduction” section on page 30). If you do not have a surveyed position on which to locate your antenna you may use the command \$PASHS,CPD,ENT along with Ashtech DBN messages. This sets the base station position to the autonomous position calculated by the receiver. The relative accuracy of the remote receiver positions is the same, with respect to the base station, as if you had entered the true position of the antenna. The absolute accuracy translates by the difference between the nominal base station position (from \$PASHS,CPD,ENT) and the true WGS84 position. That is, if the nominal base station position is one meter north of the true position, then all remote positions will be translated north by exactly one meter.

Message Rate

To improve Differential and RTK performance, minimize base station data latency by using the highest possible data rates that your data link supports. There are three different settings that affect data rates:

- RTCM message bit rate. \$PASHS,RTC,SPD. This is the internal bit rate used to generate the RTCM messages. This should be as high as possible without exceeding the baud rate of the serial port. Recommended bit rate setting is burst mode (9), which automatically adjusts the bit rate to the fastest possible rate based on the serial port baud rate:

\$PASHS,RTC,SPD,9

- Serial port baud rate. This should be as high as possible.
- RTCM message rate. This is the rate at which messages are generated.
 - RTK messages (RTCM 18 & 19, RTCM 20 & 21, Ashtech DBN) are the most important. They should be generated as fast as possible, ideally once per second. If they are generated slower then the effect

on the remote receiver depends on the mode. The slowest allowable setting for type 18 and 19 is once per 5 seconds.

- Fast RTK mode: accuracy will degrade by approximately 1cm for each second of latency (example: type 18 and 19 generated every 5 seconds, fast RTK accuracy of 5cm, horizontal 1s. Fast RTK update rate is unaffected.
- Synchronized RTK mode: accuracy is unaffected. Update rate is limited to the update rate of messages 18 and 19.
- Differential messages (1) are next most important, ideally once per second. If the data rate does not support this, these messages may be generated slower, with a corresponding decrease in differential accuracy (Figure 3.2 to see the accuracy sensitivity to lower update interval).
- RTK base station position (RTCM 3 & 22 or Ashtech BPS) are least important. They affect the RTK initialization time following power on of the remote receiver, (the remote receiver cannot provide an RTK position until it has received messages 3 and 22 once or until receiving the \$PASHS,CPD,POS command), but the rate at which these messages are generated does not affect RTK accuracy.

Required Differential Update Rates

For RTK operation there is a minimum radio baud rate that is acceptable. The required radio rate depends on which messages are being generated at the base station, and the message period. The slowest rate at which one should send RTK data is once every 5 seconds. The remote receivers can fix integers with base station data arriving once every 5 seconds or faster.

Message size

Table 3.7 lists the message size for RTCM messages 18 & 19 or 20 & 21.

Table 3.7. Message Size for RTCM Messages 18 & 19 or 20 & 21

Number of Satellites	Number of RTCM Words in Message Type 18/20 (30 bits/word)	Number of RTCM Words in Message Type 19/21 (30 bits/word)
7	$(2+1+7)*2 = 20$	$(2+1+7)*2 = 20$
9	$(2+1+9)*2 = 24$	$(2+1+9)*2 = 24$
12	$(2+1+12)*2 = 30$	$(2+1+12)*2 = 30$

Table 3.8 lists the message size for Ashtech DBN messages.

Table 3.8. Message Size For Ashtech DBN Messages

Number of Satellites	Number of Bits in DBN Message	Number of bytes in DBN Messages
7	$17*8+\text{ceil}((94+72*2*7)/16)*16 = 1240$	155
9	$17*8+\text{ceil}((94+72*2*9)/16)*16 = 1528$	191
12	$17*8+\text{ceil}((94+72*2*12)/16)*16 = 1960$	245

$$\text{ceil}(3.1) = 4$$

Required Radio Rate

For RS232 communications, 1 start bit and 1 stop bit is required for each byte. The required number of bits is 10/8 times the number of message bits.

For RTCM, the data is packed in 6/8 format. The required number of bits is 8/6 times the number of bits in the message.

For RTCM data on an RS232 link, the required number of bits is 8/6*10/8 times the number of bits in the message.

Table 3.9 lists the minimum baud rates for a receiver sending RTCM 18 & 19 or 20 & 21 messages only.

Table 3.9. Minimum Baud Rates for RTCM Messages 18 & 19 or 20 & 21

Number of Satellites	Minimum baud rate (message period = T)	Minimum standard baud rate (T = 5 sec)	Minimum standard baud rate (T = 1 sec)
7	$20*30*2*8/6*10/8*1/T$	600 bps	2400 bps
9	$24*30*2*8/6*10/8*1/T$	600 bps	2400 bps
12	$30*30*2*8/6*10/8*1/T$	600 bps	4800 bps

For Ashtech DBN messages, the required minimum baud rate is the DBN rate multiplied by 10/8. Table 3.10 lists the required baud rates.

Table 3.10. Minimum Baud Rates for Ashtech DBN Messages

Number of Satellites	Minimum baud rate (message period = T)	Minimum standard baud rate (T = 5 sec)	Minimum standard baud rate (T = 1 sec)
7	$1240*10/8*1/T$	600 baud	2400 baud

Table 3.10. Minimum Baud Rates for Ashtech DBN Messages (continued)

Number of Satellites	Minimum baud rate (message period = T)	Minimum standard baud rate (T = 5 sec)	Minimum standard baud rate (T = 1 sec)
9	$1528 \cdot 10 / 8 \cdot 1 / T$	600 baud	2400 baud
12	$1960 \cdot 10 / 8 \cdot 1 / T$	600 baud	4800 baud

Table 3.9 and Table 3.10 list the minimum baud rates, assuming no other data is sent on the data link. If other messages are transmitted, then the minimum standard baud rate may increase.

The recommended optimal setting is to transmit type 18 and 19 messages once every second on a high-speed link.

If a high speed data link is not available, you have *indirect* control over the number of satellites used, by setting elevation mask angles. The elevation angle for any particular satellite changes by 1° for every 100 km of baseline length. For baselines of less than 100 km, you should set the base station elevation mask at 1° less than the remote receiver elevations masks to guarantee that the base station sends data for all satellites the remote might use, while not sending data for low elevation satellites that the remote does not use.

Recommended mask angle settings for RTK:

Remote: 10° (Default)

Base: 9°

Use the Mission Planning software to determine the maximum number of satellites visible above a given mask angle. Table 3.11 shows the maximum number of satellites above a 4° mask angle, with the constellations available August 11, 1997, (25 GPS satellites) using a 24-hour simulation at 0° longitude. GPS geometry is primarily a function of latitude, and varies only slightly with longitude for a constant latitude.

Table 3.11. Maximum Number of Satellites Above a 4° Mask Angle

Latitude	Maximum Number of GPS SVs
0°	11
10°	12
20°	11
30°	11
40°	11
50°	10

Table 3.11. Maximum Number of Satellites Above a 4° Mask Angle (continued)

Latitude	Maximum Number of GPS SVs
60°	11
70°	12
80°	11
90°	12

Mask Angle

The base station mask angle for RTK messages 18, 19, 20, & 21 is controlled by \$PASHS,ELM. The base station mask angle for differential corrections (type 1) is controlled by \$PASHS,PEM. If your data link bandwidth is large enough, then you can set both mask angles to zero degrees for base stations. This ensures that the base station will send data for all satellites that it can “see” above the horizon.

If your bandwidth limits the number of satellites for which you can transmit base station data, then you may raise the mask angle. On baselines less than 100 km, the remote station sees satellites at approximately the same elevation angles as the base station sees them, the base station mask angle should be set one degree lower than the remote mask angle. On long baselines the elevation angle changes by approximately 1° for every 100 km. So for baselines of $x \times 100$ km the base station should not have a mask angle higher than the remote station mask minus $x \times 1^\circ$.

The two different controls allow you, for a combined RTK/Differential base station, to set the mask angles higher for RTK (which typically operates on short baselines) than Differential (which often operates on longer baselines).

Base Station Position

The RTCM messages 3 and 22 broadcast the base station position to the rover. In case DBN is used, the position is broadcast via \$PASHR,BPS. The base station position may also be entered directly into the remote unit, using the \$PASHS,CPD,POS and \$PASHS,UBP commands. This reduces bandwidth requirements by obviating the need for messages 3 and 22.

Base Station Antenna Offset

If you set up the base station antenna over a known, surveyed point, you may enter the position of the surveyed point and the offset from this point to the antenna phase center. Or you may enter the phase center directly.

If you are using 3 & 22, or BPS:

- At the base station, enter the phase center of the antenna directly using \$PASHS,POS and setting \$PASHS,ANR,OFF, or
- At the base station, enter the surveyed reference point using \$PASHS,POS and enter the antenna offset using \$PASHS,ANT and \$PASHS,ANR, ON (or keep it at CPD if running CPD mode only, not combined).

If you are entering the base station position directly at the remote:

- At the remote, enter the phase center of the base station antenna directly using \$PASHS,CPD,POS and setting \$PASHS,ANR,OFF, or
- At the remote, enter the surveyed base station reference point using \$PASHS,CPD,POS and enter the base station antenna offset using \$PASHS,CPD,ANT, and set \$PASHS,ANR,ON

Using Reference Station ID

You may monitor which reference or base station the remote receiver uses by setting a reference station ID at the base station. For RTCM, set the reference station ID using the command \$PASHS,RTC,STI. For Ashtech DBN, use \$PASHS,SIT.

For RTCM, you may also control which reference station the remote receiver uses by setting the desired station ID at the remote receiver, or the remote receiver to use corrections from any base station.

Reference Station Health

You may set the reference station to "unhealthy", which causes all remote receivers to ignore the messages they receive from that base station.

Other RTCM Messages

Message 2

These are automatically generated when the base station is transmitting differential corrections and a new ephemeris is downloaded from the satellites.

Filler: Message 6 Null Frame

This message is provided for datalinks that require continuous transmission of data, even if there are no corrections to send. As many Messages 6 are sent as required to fill in the gap between two correction messages. Messages 6 are not sent in the burst mode (\$PASHS,RTC,SPD,9)

Special Message: Message 16

This message allows you to transmit an ASCII message from the base station.

Using a PC Interface

If you are using Evaluate software to interface to your receiver you may use initialization files (*.gps) to send the base station setting commands for you. *Receiver Communication Software* can be used as well.

To monitor the corrections from a PC, turn on the MSG message

```
$PASHS,NME,MSG,port,ON
```

This generates an ASCII echo of the RTCM messages being transmitted by the base station. Use different receiver serial ports for MSG and the actual transmitted RTCM messages.

Using a Handheld Interface

If you are using Ashtech software on a handheld computer, differential set-up is controlled via a series of menus designed to free you from knowing or entering commands. Handheld software allows you to monitor and control most receiver functionality.

Remote Stations

Setting Up a Differential Remote Station

You must have the Differential remote option **[U]** installed on your receiver. You must have a source of differential corrections, usually a radio receiving a transmission from a base station. Connect this radio to one of the receiver serial ports.

Send the following commands to the receiver. The receiver will accept RTCM differential corrections in message types 1 or 9. You do not have to tell the receiver which message types to expect, it will automatically use whatever it receives on serial port c.

Table 3.12. Differential Remote Station Commands

Command	Description
\$PASHS,RST	Reset the receiver to factory defaults
\$PASHS,RTC,REM,c	Set the receiver as a remote station, receiving corrections on serial port c
\$PASHS,SPD,c,d	Set the baud rate of serial port c to the same as the radio providing the corrections.
\$PASHS,SAV,Y	Save settings

You have now set up the remote station. Turn on the GGA, GLL, POS or PBN message to obtain position.

Setting Up an RTK Remote Station

The receiver can operate in RTK remote mode using any one of the following three modes:

- RTCM Standard 18, 19, 3, and 22
- RTCM Standard 20, 21, 3, and 22
- Ashtech Standard DBN

Using RTCM Messages

Operating an RTK remote using RTCM messages is almost identical to operating a Differential remote receiver. The main differences are:

1. The data from the base station is RTCM Types (18 & 19) or (20 & 21) and 3 & 22, instead of 1 or 9.

2. The accuracy is approximately 100 times better.

You must have both the Differential remote option, [U], and the Phase differential option, [J], installed in your receiver.

You must have a source of RTK data, usually a radio receiving a transmission from an RTK base station. Connect this radio to one of the receiver's serial ports.

Send the following commands to the receiver. The receiver accepts RTCM RTK data in message types 18 (carrier phase data) and 19 (Code phase data), 20 (carrier phase corrections) and 21 (code phase corrections), 3 and 22 (base station position).

Table 3.13. RTK Remote Station Command

Command	Description
\$PASHS,RST	Reset the receiver to factory defaults
\$PASHS,RTC,REM,c	Set the receiver as a remote station, receiving corrections on serial port c
\$PASHS,SPD,c,d	Set the baud rate of serial port c to the same as the radio providing the corrections.
\$PASHS,CPD,MOD,ROV	Set the receiver as an RTK remote
\$PASHS,SAV,Y	Save settings



Make sure to issue command \$PASHS,RTC,REM,c before the \$PASHS,CPD,MOD,ROV command. Doing so in reverse order disables the CPD mode.

The receiver is set up as a RTK remote station. Turn on the GGA, GLL, or POS message to obtain position. PBN does not provide RTK position, only stand-alone or code differential.



RTK (Real Time Kinematic) and CPD (Carrier Phase Differential) are synonyms.

Using Ashtech DBN or CMR Messages

You must have the [J] option installed in your receiver.

Send the commands listed in Table 3.14

Table 3.14. RTK Remote Station Commands

Command	Description
\$PASHS,RST	Reset the receiver to factory defaults
\$PASHS,SPD,c,d	Set the baud rate of serial port c to the same as the radio providing corrections
\$PASHS,CPD,MOD,ROV	Set the receiver as an RTK remote
\$PASHS,SAV,Y	Save settings

The receiver automatically detects which port is receiving the DBEN or CMR messages and uses them in the RTK solution.

Advanced Remote Station Operation

Base Station Data

Both differential remote stations and RTK stations automatically extract the messages needed from the data coming in to the designated serial port. So you can set up a combined Differential/RTK base station (see “Setting up a Combined Differential and RTK Base Station” on page 31), and operate DGKPS remote receivers and RTK remote receivers. You can also send RTCM messages from one serial port, while sending Ashtech DBN messages from another port. You cannot send RTCM and DBN from the same port.

Any combination of RTCM messages can be sent out of the serial port designated by \$PASHS,RTC,BAS,c. One radio can then be used to support both RTK and differential operation, as illustrated in Figure 3.1.

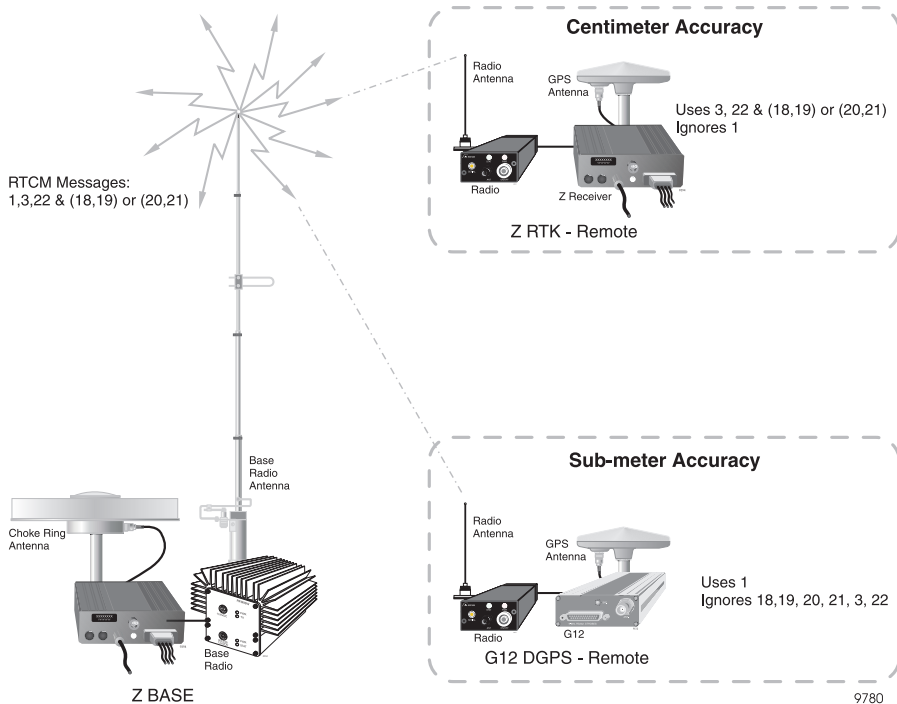

Figure 3.1. Combined Differential/RTK Base Station and Remote Operation

Ashtech remote receivers (both Differential and RTK) operate with any base station that generates the industry standard RTCM messages.

Base Data Latency

Both Differential and RTK operation are better the lower the latency of the Base-Remote data link. To minimize latency set the baud rate of the radios as high as possible, and use radios that are optimized for low latency GPS operation, such as the Ashtech SSRadio.

Maximum acceptable base-remote data latency is controlled by \$PASHS,RTC,MAX for code differential mode and by \$PASHS,CPD,MAX for RTK mode.

The latency is indicated in the “age of correction” field of the GGA message. The age increments when the correction message is not received or if it is invalid (bad checksum). When the age reaches max age, the differential position does not output anymore (for more information see, “Auto Differential Mode” section on page 54).



In the case of CPD with RTCM 18 & 19 or 20 & 21, if the message is partially received, for enough satellites to compute a position, the age increments, but a position solution is still derived, and continues to be output even if MAX AGE is reached.

Differential Accuracy vs. Base Data Latency

Figure 2 shows the growth of position error with increasing latency for DGPS.

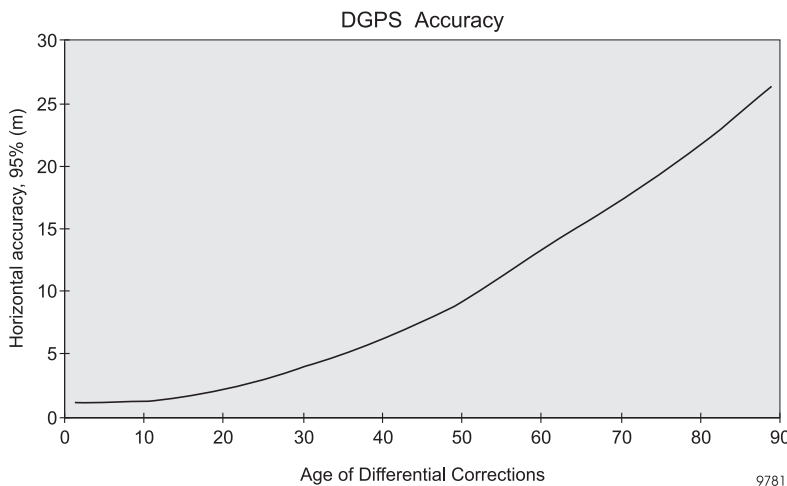

Figure 3.2. DGPS Accuracy

Choosing Between Fast RTK and Synchronized RTK

With an RTK remote receiver you can choose between three modes of RTK position computation:

1. Synchronized RTK
2. Fast RTK (F option required)
3. 5 Hz synchronized RTK (H option required)

Choosing the right mode for your application is a decision based upon a trade-off between frequency of position output and accuracy of position.

Synchronized RTK

Synchronized RTK (also called matched time tag RTK) means that the remote receiver will compute and output an RTK position for each DBEN, RTCM 18/19 or 20/21, or CMR message it receives from the base receiver. In normal synchronized RTK, the maximum transmission rate from the base receiver is 1 Hz.. Therefore, the maximum position output rate at the remote receiver is also 1 Hz. If there is an interruption at the base receiver or interference in the data link

that blocks transmission of data from the base receiver, this frequency may decrease. The rover will only provide an RTK position when it receives data from the base receiver. Therefore, with synchronized RTK, the latency of the rover position is approximately equal to the latency of the base-remote data link. However, because the time tags of the base and rover observables are matched and because the data latency is low, the positions are consistently very accurate. The accuracy of synchronized data is typically 0.5 cm + 1ppm.

Fast RTK

In Fast RTK (also known as Fast CPD) mode, the rover receiver can output centimeter level RTK positions at rates up to 10 Hz. Fast CPD works by using a single base station carrier phase message to compute additional rover RTK positions. In this mode, positions are more independent of the rate at which it receives DBEN, RTCM 18/19 or 20/21, or CMR messages from the base receiver. Fast CPD should be used when regular and high frequency position updates are required (such as in machine control), and when consistent position accuracy is not the highest priority. The accuracy is a function of the latency. The typical accuracy in centimeters is equal to the base-remote data latency in seconds (1s horizontal) for data latency of up to 10 seconds. After 10 seconds, the position is no longer centimeter level accuracy. Any degradation in position, either because of latency or cycle slips can be monitored in the RRE message. Because Fast RTK is running synchronized RTK in the background, any degradation is usually temporary. Cycle slips are typically fixed at the next synchronized epoch.

5 Hz Synchronized RTK

5 Hz Synchronized RTK is a new feature that combines the accuracy of synchronized RTK with position output rates that approach those of Fast CPD. Data is transmitted at a faster rate from the base receiver, allowing the rover to compute more frequent matched time tag RTK positions. In this mode, the rover is capable of outputting RTK positions up to 5 times per second.

Assuming that the [H] option is installed, the receivers are set up in 5 Hz synchronized RTK mode by setting the base receiver to transmit data at a 5 Hz rate and the rover to output RTK positions at 5 Hz. Note that the 5 Hz synchronized RTK only works for DBEN and CMR messages.

Enable the base station to transmit data at 5 Hz by sending the following command to the base receiver: `$PASHS,CPD,PED,0.2 <enter>`.

Enable the rover to output RTK positions at 5 Hz by sending the following command to the rover receiver: \$PASHS,CPD,PER,0.2.

Even if the \$PASHS,CPD,PER or \$PASHS,RCI message is set to 0.1, the rover can only output positions at a maximum interval of 0.2 seconds when 5 Hz synchronized RTK is running. Also, it is strongly recommended that Fast CPD not be enabled when running 5 Hz RTK. Lastly, be aware that when CPD is outputting positions higher than 1 Hz, the receiver will only use the 10 highest satellites for CPD position computation.

Position Latency

Base data latency, discussed above, is the delay between when a base station measures the GPS signals and when the remote receiver receives the RTCM or DBN messages. *Position latency* is the delay between when the remote receiver measures the GPS signals and when the position is available at the serial port. In other words, position latency is the delay in providing the user's actual position to the user. Position latency is typically less than 50 milliseconds, it varies with the number of satellites in view.

Float and Fixed Solutions

When the receiver is in RTK mode the crucial difference from Differential mode is that it uses the carrier phase measurement to generate the range measurements to centimeter accuracy. The receiver can measure the fractional part of the carrier phase to centimeter accuracy, it derives the integer number of full carrier phase wavelengths by processing both the carrier and code phase measurements. This process of deriving the integer numbers is known as integer ambiguity resolution or carrier phase initialization. This carrier phase initialization is only necessary following power-on, or after the receiver has lost lock on the satellites (e.g. after passing under a bridge). The receiver performs carrier phase initialization automatically. The receiver does not have to be stationary while initializing. Once the receiver is initialized it will provide centimeter-level accuracy, while moving, in real time. The time for carrier phase initialization is a few seconds up to several minutes, depending on baseline length, number of satellites in view, and required reliability; these are discussed in the next section.

During the carrier phase initialization the receiver is said to be in "float" mode, once initialization is complete the receiver is said to be in "fixed" mode. This terminology derives from computer terminology: floating-point numbers (real numbers) and fixed numbers (integers).

When in float mode the accuracy will range from Differential accuracy (1m) down to sub-decimeter. The longer the receiver has been in float mode the higher the accuracy. Convergence time is a function of baseline length and number of satellites in view. When the receiver fixes integers, accuracy makes a quantum change to centimeter level.

The POS and GGA messages have fields which indicate whether the receiver is in float or fixed mode.

Carrier Phase Initialization

The time required for carrier phase initialization is a function of base-remote baseline length, number of satellites in view, satellite geometry, and required reliability. With a large number of satellites in view (Š7), initialization time can be as low as a few seconds. With fewer satellites in view, the receiver takes as long as necessary to guarantee the required reliability.

Reliability

The process of carrier phase initialization has a non-zero probability of error. If an error is made the receiver will fix the integers to the wrong value. This will result in floating point accuracy (typically between 10cm and 1m). After an error in fixing integers the receiver automatically detects and corrects the error when the satellite geometry changes. This may be as soon as a new satellite comes into view, or, in the worst case, when the satellites move by a few degrees in the sky, which can take from one to more than 10 minutes.

You can control the reliability that the receiver provides, this indirectly controls the speed of carrier phase initialization. The higher the reliability the longer it takes to fix integers.

The receiver offers three modes for ambiguity fixing:

- a. Fixed solution, formal reliability = 90%
- b. Fixed solution, formal reliability = 95%
- c. Fixed solution, formal reliability = 99% (default)
- d. Fixed solution, formal reliability = 99.9%

The command \$PASHS,CPD,AFP controls the ambiguity fix parameter.

The four choices of formal reliability for fixed solution are provided to allow you to trade off speed with reliability. The AFP setting controls the internal thresholds of the receiver so that the expected statistical reliability of getting correctly fixed integers is 90%, 95%, 99%, or 99.9% respectively. The receiver fixes integers faster with AFP=99 than with AFP=99.9. While the receiver is busy fixing integers, it gives a float solution.

Operation under trees, or in other areas with frequent blockage of satellites signals will lead to significantly degraded results.

Monitoring Accuracy

Besides fixed/float status, position accuracy is the most important consideration when using the receiver for real time carrier phase positioning. The primary means of monitoring CPD “fixed” and CPD “float” accuracy is the RRE message

(see NMEA section for full description). The RRE gives an indication of the overall quality (precision) of the CPD position by displaying the RMS value of the error of all the range inputs to the position solution. The RRE message also gives a real-time estimate of the actual error in the CPD position in horizontal error and vertical error. The actual position error of the system will be less than the standard deviations displayed in the RRE approximately 68% of the time. If you multiply the standard deviations by 2, the result is a conservative estimate of actual accuracy about 95% of the time.

The quality of the RRE estimates improve with increasing number of satellites. The RRE estimates may be very unreliable with only 5 satellites in view. The horizontal estimates are derived from:

$$\sqrt{(LatError)^2 + (LonError)^2}$$

GST estimates of latitude, longitude, and altitude accuracy automatically account for DOP, SNR, and many other factors. These parameters are built into the GST estimate already and do not have to be recomputed by the user.

Required Number of Satellites

The receiver requires five or more satellites to fix integers, following power on, or obstruction and re-acquisition. If the solution is fixed with five or more satellites, and the number of satellites falls below five but stays above three, the solution stays fixed and accuracy remains at the centimeter-level. Positions are always three-dimensional when in RTK mode. Two-dimensional positions, using previously calculated altitudes, are not possible.

Mask Angles

At the remote station the position elevation mask is always controlled by \$PASHS,PEM, whether the receiver is in Differential mode or RTK mode.

Auto Differential Mode

When a user operates a rover receiver in differential mode (either code phase or carrier phase), a failure at the base station or in the data link causes the rover receiver to cease outputting differentially corrected positions. Auto differential mode allows the user to output an autonomous position at the rover receiver if differential data from the base station is unavailable. Auto differential mode is

enabled by entering the command \$PASHS,RTC,AUT,Y. Table 3.15 describes how auto differential mode affects position output at the rover receiver.

Table 3.15. Auto Differential Modes and Position Output

Mode	Position Output
Code differential Auto Differential Off (Default code mode)	Differential position output if the age of corrections is less than maximum age (maximum age as defined in the rover by \$PASHS,RTC,MAX). No position otherwise.
Code differential Auto Differential On	Differential position is output if the age of corrections is less than maximum age, otherwise an autonomous position is output.
Carrier differential Fast CPD On Auto Differential Off (Default carrier mode)	Once the rover mode has been enabled, autonomous position outputs until it has computed the first CPD position. A CPD position solution continues to output until the age of corrections is greater than the maximum age.
Carrier differential Fast CPD On Auto Differential On	Once the rover mode has been enabled, autonomous position outputs until it has computed the first CPD position. A CPD position solution continues to output until the age of corrections is less than the maximum age, otherwise an autonomous position is output.
Carrier differential Fast CPD Off Auto Differential Off or On	Once the rover mode has been enabled, autonomous position outputs until it has computed the first CPD position. A CPD position solution continues to output until corrections stop, and no position outputs unless corrections are available.

RTCM Messages

The receiver accepts RTCM 104 version 2.3 differential formats. The receiver is set to differential mode in any of the serial ports with the set command \$PASHS,RTC,str,c where str is BAS or REM and c is the port. Of RTCM message types 1 through 64, the receiver processes only: types 3, 16, and 22 for Base station location and special information; types 1, 2, and 9 for RTCM differential corrections, null frame type 6, and RTK data message types 18, 19, 20 and 21. The differential corrections are automatically processed by the receiver. For diagnostic purposes, the RTCM messages can be output in an ASCII format on the rover side via the MSG command (see "MSG: Base Station Message" on page 217.).

On initial power-up or after use of the \$PASHS,RST reset to defaults command, the receiver default automatic differential mode is OFF, and the default is 60 seconds for the maximum age of an RTCM differential correction above which it will not be used. If the automatic mode is not enabled by the \$PASHS,RTC,AUT,Y set command and the differential correction data is older than the maximum age specified by the \$PASHS,RTC,MAX set command, the receiver does not return antenna position data.

In automatic mode, if no differential correction data is received and the age of data is older than the specified maximum age, the receiver does return the uncorrected raw position.

RTCM 104 Format, Version 2.3

When the receiver is used as a reference station and the RTCM and RTK Base options are enabled, it computes differential corrections for up to 12 satellites, converts those corrections to RTCM format, and transmits the converted messages via its serial ports. It can generate message types 1, 2, 3, 6, 16, 18, 19, 20, 21, 22 as detailed in Table 3.16.

Table 3.16. RTCM Message Types

GPS Message Type	Contents of Message
1	Differential GPS corrections
2	Delta differential corrections
3	Reference station parameters in WGS 84
6	Null frame
16	Special GPS text message
18	RTK carrier phase
19	RTK pseudo-ranges
20	RTK carrier phase corrections
21	RTK code phase (pseudo-range) corrections
22	Extended reference station parameter

The receiver uses the six-of-eight format (data bits a1 through a6 of an eight-bit byte) for communication between the reference station and user equipment.

When the receiver is used as remote equipment and the RTCM and RTK remote options are enabled, it can accept any type of RTCM message. However it decodes types 1, 2, 3, 6, 9, 16, 18, 19, 20, 21, and 22 uses only types 1, 2, and 9 for differential corrections and types 3, 18, 19, 20, 21, and 22 for RTK corrections.

For radio communication, the receiver in remote mode can recover bit slippage.

4

Understanding RTK/CPD

This chapter covers CPD operation in more detail by describing CPD solution monitoring, solution output and storage, trouble shooting, and performance optimization. RTCM reference station setup is also described briefly. The front panel setup does not provide access to CPD rover mode, which must be configured by using serial commands (CPD base can be set via the front panel for the Z-Surveyor and Z-FX).

For detailed information on the commands and responses that are mentioned in this chapter, please refer to Chapter 6, **Command/Response Formats**.

The following operation procedure applies to RTCM-RTK with type 18 & 19, 20 & 21, or RTK with Ashtech DBN message.

Monitoring the CPD Rover Solution

When a receiver is set to CPD rover mode, you can monitor the current CPD solution status and positions with the following commands:

- \$PASHQ,CPD—shows the CPD setup in a tabulated format
- \$PASHQ,CPD,MOD—shows the CPD setup in a \$PASHR format
- \$PASHQ,CPD,INF—shows the satellite information in CPD operation
- \$PASHQ,CPD,STS—shows the current ambiguities fixing status
- \$PASHQ,RRE—shows the post-fit carrier phase residual in CPD solution

Positions can be also monitored from GGA message or CBN message.

How to Tell If the Integer Ambiguities are Fixed

The ambiguities fixing status can be determined through the following messages:

- STS
- GGA
- CBN
- CPD

In \$PASHR,CPD,STS message, if the second field > 1.0, it means that the ambiguities are fixed. For example,

```
$PASHR,CPD,STS,0.005,0124.72*5C
```

In \$GPGGA message, a solution type of “3” in the sixth field indicates that ambiguities are fixed.

```
$GPGGA,212349.00,3722.378424,N,12159.841801,W,3,08,01.0,-  
00005.078,M,-032.121,M,014,*82
```

In ASCII \$PASHR,CBN message, a “1” in the third digit of the solution type field indicates the ambiguities are fixed.

```
$PASHR,CBN,212501.00,????,08,001.2,3722.3784261,N,12159.8417992,W,-  
00005.0847,00.011,00.011,00.012,-00.000,+00.000,-00.000,221001,+000.000,-  
000.001,+000.001, 00.000,00.000,00.000*6C
```

In a CBN message, the solution RMS values represent one-sigma solution accuracy. A fixed ambiguity solution should have all three RMS values < 0.03 meters, with PDOP < 4.0.

 You can also look at the \$PASHR,CPD message for ambiguities fixing status. Refer to CPD: RTK Status on page 256.

Data Link Monitor

The Data Link Status can be monitored via \$PASHQ,CPD,DLK message. Pay special attention to the SV list and QA. Refer to \$PASHQ,CPD,DLK,c on page 260.

CPD Solution Output and Storage

The raw GPS measurements, autonomous position, RTCM positions, or CPD solutions can be outputted to the serial port for monitoring and logging. If a receiver has a PC data card, the data can be stored on the PC data card as well as downloaded to a PC.

Real-time Solution Output

The CPD rover position, velocity, and other solution information can be output via the receiver's serial port, in CBN message format or NMEA message format. The CBN message output rate is controlled via the \$PASHS,RCI command.



The PBN message will always output autonomous position or code differential position (if messages 1 or 9 are available).

The CBN message can provide more complete information on position, velocity, solution status, position RMS and covariance, number of satellites, and PDOP. The CBN message output can be in ASCII or binary format. The binary format is bitwise packed and is not IEEE format compatible.

To output the CBN message, use the \$PASHS,OUT command.

To output the NMEA messages, use the \$PASHS,NME commands.

If for any reason the CPD solution cannot be computed for an epoch, there will be no CPD solution output for that epoch in any real-time or NMEA message.

Other solution messages are also available for query, and not to output periodically like CBN messages. These messages are UBN and OBN. The UBN message gives CPD position, velocity, and statistical information in binary format. The OBN message gives CPD vector and site information in binary format.

Vector Solution Output

This capability allows you to log vector solutions containing the same information as post-processed vector output files (O-file), allowing the position solutions to be imported into an adjustment program. Your RTK solutions may then be included as part of a least-squares network adjustment.

To use this option, a valid site name must be entered (check by using the \$PASHQ,RAW command), and the rover's GPS antenna must remain stationary until the site name has been changed to "?????". If the GPS antenna is moving with a site name entered, the vector solution will not be valid. If no site name is entered, the vector solution will not be created. Note that a site name must be entered at the base station as well.

Other Ashtech real-time Z products, such as GPSTopo, with software running on a handheld datalogger automate this process, but it may be performed in the receiver system using the following procedure:

1. Check the solution, as described in Monitoring the CPD Rover Solution on page 57, to ensure that the current accuracy meets your requirements.
2. Place the antenna over the point to be measured.

3. Issue the following serial commands to the receiver using Ashtech's REMOTE.EXE program or a similar serial communication:
\$PASHS,CPD,DYN,0
\$PASHS,CPD,FST,OFF
\$PASHS,SIT,xxxx (where xxxx is the site name you wish to use other than ????)

These three commands set rover motion dynamics to static, turn Fast CPD off, and set a site name.

4. To improve the vector solution, you may wait for 5-10 epochs of data before issuing the next set of commands:
\$PASHS,CPD,DYN,2
\$PASHS,CPD,FST,ON
\$PASHS,SIT,????

These three commands reset the unit for dynamic operation.

5. Wait for more than two seconds, and then enter the next command to log the solution to the OBN file:
\$PASHQ,OBN
6. Verify the site name in the vector solution. If it does not match, query again.
7. You can move the GPS antenna to the next site.

Solution Storage

The CPD solution can be stored in receiver memory in Ranger mode 2 or Ranger mode 4.

If your receiver has a PC data card, you can store the raw measurements and the solution information into the receiver's PC data card. These data can then be downloaded to a PC into B, C, E and S-file format via Ashtech's Download program at a later time.

- To create/delete files, use \$PASHS,FIL command.
- To select file storage type, use \$PASHS,RNG command.
- To check the memory usage, use \$PASHQ,FLS command.
- To verify the data recording setup, use \$PASHQ,RAW.

When setting up a receiver to store solutions, pay special attention to the following items:

- Recording interval
- Minimum number of SVs
- Elevation mask
- Ranger mode type
- Recording is set to Yes
- Site name

Since CPD is a differential operation, a solution may not be available if the differential data link is lost. However, the receiver will always store the raw measurements whether the CPD solution is available or not. When the CPD solution is not available, the position computed by the raw pseudo-ranges, or the autonomous position, may be stored instead (see Auto Differential Mode on page 54 for more information).



Information in CBN, OBN, and UBN cannot be stored in receiver memory.

Troubleshooting

The following problems are sometimes encountered by users new to the receiver. If your system isn't working properly, please refer to this list. If you need further assistance, please call a Technical Support representative.

Table 4.1. Troubleshooting Tips

Symptom	Action
PC cannot communicate with receiver	<ul style="list-style-type: none"> • Verify cable connections. • Verify communication BAUD rate and communication software setting. • If symptom persists, cycle power. • If symptom persists on Z-Xtreme, press the Enter button while powering up to clear the internal memory. • If symptom persists on Z-Surveyor or Z-Fx, press both buttons on the front panel while powering up to clear internal memory.
receiver not in RTK Rover mode	<ul style="list-style-type: none"> • Verify the receiver is capable of RTK operation (refer to Receiver Options on page 2 for J or U option). • Verify the receiver is in Rover mode with \$PASHQ,CPD and \$PASHQ,RTC.
\$PASHQ,CPD,DLK has no information	<ul style="list-style-type: none"> • Verify that the receiver is in CPD base mode or in CPD rover mode. • Verify that the antenna connection is connected to the GPS antenna. The GPS antenna must be mounted outdoors, with a clear view of the sky. Nearby buildings and vegetation can block the GPS signals or introduce multipath by reflecting the GPS signals. • Verify the receiver is computing autonomous position properly. • In the base receiver Verify the entered base station coordinates as well, as described in next trouble shooting In the rover receiver, verify the data link between the base and rover/remote. In case of hardwired data link between receivers from different vendors, check the hardware handshaking in the RS-232 connection.
Base beeps	<ul style="list-style-type: none"> • The entered coordinates differ from the computed coordinates by more than 500 meters. • Verify the receiver is computing autonomous position properly. • Verify and re-enter the coordinates or enter the raw position as the base coordinates as described in Base Position Coordinates Selection: \$PASHS,CPD,UBS on page 67.

Table 4.1. Troubleshooting Tips (Continued)

Symptom	Action
No CPD solution	<ul style="list-style-type: none"> • Verify that there are at least four common satellites between the base and the rover, using \$PASHQ,CPD,INF command. • Verify that base station coordinates have been received in the rover side, using \$PASHQ,CPD,POS command. If the coordinates are not being received, make sure the base is sending them periodically, using \$PASHQ,CPD,DLK command or \$PASHQ,RTC command. Or you can enter the base station coordinates in the rover side, using \$PASHS,CPD,POS command. • For Z-Sensor, and Z-Eurocard, check that there are no warnings (\$PASHQ,WARN).
CPD solution is intermittent and the Rover beeps	<ul style="list-style-type: none"> • Monitor the data link quality, using the \$PASHQ,CPD,DLK command. The QA number should be 90% or higher. • Verify that fast CPD is turned on, using \$PASHQ,CPD or \$PASHQ,CPD,MOD command. • Verify the rover antenna has clear view to the sky and is tracking satellites properly.
Cannot get fixed CPD solution	<ul style="list-style-type: none"> • Verify using \$PASHQ,CPD,INF command that at least 5 SVs are being tracked for P1 and P2. • Verify that the number of satellites common between the base and rover is 5 or more. Even if 5 or more satellites are tracked, you still may not get a fixed solution at locations with severe multipath. • Move away from the obstruction if possible. Issue \$PASHS,CPD,RST command to reinitialize the CPD operation.
CPD solutions are not being stored in the Rover	<ul style="list-style-type: none"> • Verify that PC card is inserted. • Verify that \$PASHQ,CPD,OUT is selected to output CPD solution. • Verify that REC is set to Y in \$PASHR,RAW message. • Verify there is still memory available. Verify the record interval.
Cannot get the CPD solution output in real-time	<ul style="list-style-type: none"> • Make sure the communication BAUD rate is correct. In RTCM operation, the receiver port is not being set to RTCM base or REMOTE. • Verify the output selection, using \$PASHQ,RAW and \$PASHQ,PAR commands.

System Performance Optimization

Table 4.2 lists the commands which are provided for optimizing the CPD operations.

Table 4.2. CPD optimization commands

Command	Description
\$PASHS,CPD,AFP	Selects the ambiguity fixing parameters
\$PASHS,CPD,DYN	Changes the Rover dynamics
\$PASHS,CPD,FST	Turns on/off fast CPD operation
\$PASHS,CPD,MTP	Changes the expected multipath in the system
\$PASHS,CPD,PED	Changes the DBN output interval
\$PASHS,CPD,PER	Changes the CPD update interval
\$PASHS,CPD,RST	Reinitializes the CPD operation
\$PASHS,CPD,UBS	Selects which base station coordinates to use.

Ambiguity Fix: \$PASHS,CPD,AFP

The ambiguity fixing parameter can be set to different confidence levels between 90.0 and 99.9. Higher confidence levels result in longer search times but increase the reliability of the ambiguity fixed solution.

The ambiguity fix mode can be set from 90.0 to 99.9. The default setting of 99.0 is recommended for most static and kinematic surveying applications. Setting the mode to 99.9 results in the highest reliability that the ambiguities are fixed correctly, but also results in a longer time to resolve the ambiguities and give the fixed solution. Setting the mode to 95.0 decreases the time to solve the ambiguities and give the fixed solution, but also increases the chances that the ambiguities are fixed incorrectly. Setting the mode to 90 results in the shortest time to resolve the ambiguities; however, mode 90.0 also has the highest chance that the ambiguities are fixed incorrectly.

Figure 4.1 shows the test results for over 12,000 ambiguity fix test performed by Ashtech on a Z-12 RZ receiver at various baseline lengths up to nine kilometers. These test results indicate that at the default setting, the typical time to resolve the ambiguities is 60 seconds, with a reliability of 99.9%. At the fastest setting, the results indicate that the typical time to resolve the ambiguities is five seconds, with a reliability of 97.6%.

If the ambiguities are fixed incorrectly, the satellite geometry must change appreciably before the ambiguities will again fix correctly. For a static rover, this will happen within approximately 10 minutes, or when a new satellite is acquired.

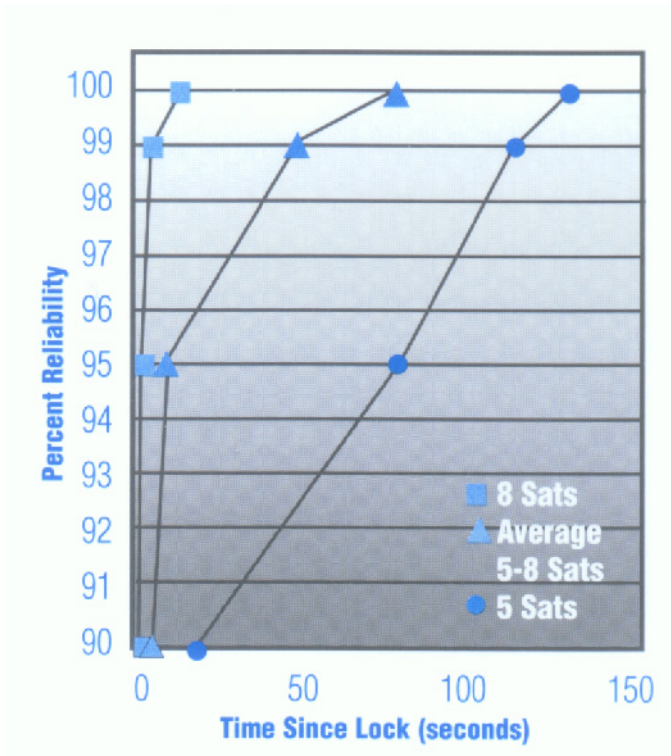

Figure 4.1. Ambiguity Fix Test Results

Dynamics: \$PASHS,CPD,DYN

Select the dynamics for the fastest acceleration you expect to be moving. If the dynamics are not set properly, the CPD solution will be less accurate. Use the STATIC dynamics mode only if the antenna will remain on a solid setup such as a tripod. If the antenna is on a pole that may have some slight movement, select Q-STATIC. If you are doing stop-and-go kinematic or rapid static surveys, the WALKING (default) or AUTOMOBILE dynamic should be selected. SHIP dynamics assume limited vertical movement. AIRCRAFT dynamics assume higher speeds and accelerations.

Fast CPD: \$PASHS,CPD,FST

Fast CPD off achieves the ultimate in GPS accuracy. With Fast CPD off, sub-centimeter position solution accuracy can be obtained with fixed integer ambiguities. However, it suffers from solution delay. This delay is caused by measurement and radio link delays. The measurement delay is about 1 second. Typical radio data link delays are about 1 second also. DLf and Tf are not shown in \$PASHR,CPD message when Fast CPD is off.

For surveying application where accuracy has higher concern over the latency, fast CPD should be turned off, especially when collecting data for static points.

Turning Fast CPD on (default) reduces the solution delay to about 50 millisecond. Because Fast CPD computes the position as soon as Rover measurement has been collected, it does not suffer from radio link delays. However, the position accuracy is only 2-3 centimeters.

Turning FAST CPD on also allows the solution to be available when there is a temporary data drop-out from the base station.

Multipath: \$PASHS,CPD,MTP

Set this parameter to the expected GPS signal multipath environment according to the list below:

SEVERE	Forest, urban canyon
HIGH	Water surface, nearby buildings
MEDIUM	Cropland, occasional tree or building (default)
LOW	Flat terrain, no nearby objects
NONE	No multipath, for testing purpose only

DBN Message Interval: \$PASHS,CPD,PED and CPD Update Rate: \$PASHS,CPD,PER

In some application where the data link bandwidth is not wide enough to transmit the DBN or RTCM message at 1Hz rate, you can slow down the DBN or RTCM output rate in the base side and slow down the CPD update rate in the rover side.

To change the DBN message interval at the base, use \$PASHS,CPD,PED command.

To change the CPD update rate between 1 and 5 seconds, using \$PASHS,CPD,PER command. This will affect the CPD solution update rate when fast CPD is off, but not with the fast CPD on. The fast CPD update rate is controlled by \$PASHS,RCI command for recording on a PC data card or raw data output (CBN, MBN,...), and \$PASHS,NME,PER for real-time NMEA output.



It is important to set the rover's update rate to match the base's DBN message output interval.

Initialization: \$PASHS,CPD,RST

If you wish to reset the carrier phase cycle ambiguities that have been found, send \$PASHS,CPD,RST command. Note that your position accuracy will temporarily degrade and you should wait until the ambiguities are fixed again before expecting centimeter accuracy.

Base Position Coordinates Selection: \$PASHS,CPD,UBS

If the transmitted base position were entered incorrectly at the base, you may change this field at the rover to USE ENTERED BASE POS (with \$PASHS,CPD,UBS) and then enter the correct base coordinates via \$PASHS,CPD,POS command. The CPD data link status on response of \$PASHQ,CPD or \$PASHR,CPD,DLK message will display the RCVD CORD age as "999 SEC" when the entered page position is used.

If you are using the transmitted coordinates, which is the recommended method, you can verify the transmitted position by sending \$PASHQ,CPD,POS command.

Base Station Elevation Mask: \$PASHS,ELM

In the base station, set the elevation mask angle to 5 degrees to ensure the maximum coverage. In the rover, you can set a different elevation mask angle for position computation, using \$PASHS,PEM command.

Universal RTCM Base Station

With the addition of RTCM type 18 & 19 or 20 & 21 message, a single receiver RTCM base station can

- Generate type 1 or type 2 message for code differential operation for receivers with RTCM differential options, such as Z-12, RZ Sensor, G-12, GG-24, SCA-12, receiver, etc.
- Generate type 18 & 19 or 20 & 21 message for CPD (RTK) operation in receiver.

This makes the receiver a universal RTCM reference station. All types of messages can be mixed to meet the system accuracy requirements and the radio bandwidth requirements.

Table 4.3 lists the recommended message schedules.

Table 4.3. Default RTCM Message Schedules

Message Type	Interval (seconds)
1	1
2	0 (off)
3	60 (1 minute)
6	ON
16	Off
18/19	1
20/21	1
22	60 (1 minute)

For CPD (RTK) application only, you can turn on type 3 and/or 22 and type 18/19 or 20/21 only.

For RTCM code differential only, you can turn on type 1 to be continuous and turn off all other messages.

Instant-RTK

When the Instant-RTK™ firmware is installed, you can choose the [I] option which significantly improves the ambiguity fix performance. The integer ambiguities can be initialized instantaneously most of the time if 6 or more satellites are used with reasonable open sky. Three reliability levels (95%, 99%, (default), and 99.9%) can be chosen. A reliability setting other than these three levels will automatically go to the default option. Table 4.4 shows the percentage of ambiguity initialization using a single epoch based on over 100,000 ambiguity fix tests at various baseline lengths up to eight kilometers.

Table 4.4. Percentage of Ambiguity Initialization Using a Single Epoch

Reliability Level	Six Satellites or More	Seven Satellites or More	Eight Satellites or More
95.0%	92.06	95.46	98.92
99.0%	87.22	92.01	97.27
99.9%	80.65	87.09	95.51

CMR Format

Compact Measurement Record or CMR format is a non-proprietary RTK format that uses data compression techniques to reduce the bandwidth required to transmit RTK data from the base to the rover receiver. In other words, the amount of data that must be transmitted on the datalink to perform RTK operations is less with CMR than with other formats.

Because the CMR format requires half the bandwidth of equivalent RTCM messages, users will be able to use relatively slow data links (9600) and still produce accurate results. Users with faster datalinks may experience smaller latency times.

Setting Up Your Receivers to Use CMR Format

Base Receiver:

Set the base receiver to output in CMR format by entering the serial command: `$PASHS,CPD,PRO,CMR <enter>`.

When using a receiver with an LED Display Interface, the CMR format is turned on via the SURVEY:RTK BASE sub-menu. Select the CMR option.

Rover Receiver:

The rover is setup to receive CMR format messages by default. No additional setup parameters are necessary.

5

Coordinate Transformation

This chapter discusses the coordinate transformation features of your receiver.

Background

GPS determines the three-dimensional positions of surveyed points based on the WGS84 datum. These coordinates are either presented as geocentric Cartesian coordinates (X,Y,Z) values or geodetic coordinates (latitude, longitude, ellipsoidal height).

There are circumstances where it would be desirable to have positions represented in a different reference frame or format, i.e. based on a different datum or projected onto a plane (grid coordinates).

The Z-Xtreme provides the following on-board tools to transform WGS84 coordinates into various formats and reference frames:

1. Datum-to-Datum Transformation

Using this feature, WGS84 coordinates can be transformed into coordinates based on another datum.

2. Datum-to-Grid Conversion

With this tool, a grid system can be defined to convert geodetic coordinates into grid coordinates.

3. Elevation Modeling

Using an on-board geoid model, ellipsoidal heights can be transformed into orthometric heights using this capability.

Table 5.1 provides an overview of user coordinate transformation functions for your receiver.

Table 5.1. User Coordinate Transformation Functionalities

Transformation	Description
Datum to Datum	3D (7-parameter) datum transformation between two Cartesian XYZ systems associated with the WGS84 datum and local datum defined by the user.
Datum to Grid	Data projected from a geodetic system, associated with WGS-84 or a user-defined datum and a specified grid system. Map Projections Supported <ul style="list-style-type: none"> • Mercator (EMER) • Transverse Mercator (TM83) • Oblique Mercator (OM83) • Sterographic (Polar and Oblique) (STER) • Lambert Conformal Conic (2 standard parallels) (LC83) Special Map Projections Specific to NAD27 <ul style="list-style-type: none"> • Transverse Mercator 27 (TM27 and TMA7) • Oblique Mercator 27 (OM83) • Lambert Conformal Conic 27 (LC27)
Elevation Modeling	Interpolation of geoidal undulations

The remainder of this chapter describes in more detail the coordinate transformation features of your receiver.

Datum to Datum

The receiver normally computes and outputs positions in the WGS-84 coordinate reference frame. However, it is possible to output positions in NMEA messages in a number of different pre-defined datums, as well as in a user defined datum.

To set the receiver to output positions in a different datum, use the \$PASHS,DTM command. Once set to a different datum, then all position outputs in NMEA messages such as GGA and GLL and the position displayed on the LED screen are referenced to the chosen datum. For a list of Datums, refer to Appendix A, **Reference Datums & Ellipsoids**.

If the list of datums does not include a datum of interest to you, you can define a datum and load it on the receiver, using the \$PASHS,UDD command along with the \$PASHS,DTM command. Prior to using these commands, define the required parameters including the length of the semi-major axis and amount of flattening in the reference ellipsoid and the translation, rotation, and scale between the user defined system and WGS-84.



The rotation and scale parameters are only available in version ZC00 or later.

The generic formula used to translate and rotate from coordinate system 1 to coordinate system 2 is as follows:

$$\begin{bmatrix} x \\ y \\ z \end{bmatrix}_2 = \begin{bmatrix} \Delta x \\ \Delta y \\ \Delta z \end{bmatrix} + (1 + m \times 10^{-6}) \begin{bmatrix} 1 & \varepsilon_{rz} & -\varepsilon_{ry} \\ -\varepsilon_{rz} & 1 & \varepsilon_{rx} \\ \varepsilon_{ry} & -\varepsilon_{rx} & 1 \end{bmatrix} \begin{bmatrix} x \\ y \\ z \end{bmatrix}_1$$

where $\varepsilon_{rx} = e_x$ expressed in radians, similarly for ε_{ry} and ε_{rz} .

Example: Define local datum as the WGS-72 datum

Send the following commands to the receiver:

\$PASHS,UDD, 0,6378135.0, 298.26,0,0,4.5,0,0,-0.554,0.23

\$PASHS,DTM,UDD

This implements the transformations listed in Table 5.2 and below.

Table 5.2. Ellipsoid Parameters for WGS-72 and WGS-84

Datum	Reference Ellipsoid	a[m]	1/f
WGS-72	WGS-72	6378135.0	298.26
WGS-84	WGS-84	6378137.0	298.257223563

$$\begin{aligned} \Delta x = \Delta y = 0 & & \Delta z = 4.5 \text{ meters} & & m = 0.23 \times 10^{-6} \\ \varepsilon_x = \varepsilon_y = 0 & & \varepsilon_z = -2.686 \times 10^{-6} \text{ radians} & = -0.554 \end{aligned}$$

in the following equation:

$$\begin{bmatrix} x \\ y \\ z \end{bmatrix}_{\text{WGS84}} = \begin{bmatrix} 0 \\ 0 \\ 4.5 \end{bmatrix} + (1 + 0.23 \times 10^{-6}) \begin{bmatrix} 1 & -2.686 \times 10^{-6} & 0 \\ 2.686 \times 10^{-6} & 1 & 0 \\ 0 & 0 & 1 \end{bmatrix} \begin{bmatrix} x \\ y \\ z \end{bmatrix}_{\text{WGS72}}$$

After issuing the \$PASHS,DTM,UDD command, the receiver internally transforms positions **from** the reference datum (WGS-84) **to** the user-defined datum. In standard text books, however, the datum transformations are given **from** local datums **to** WGS-84. To simplify entering the transformation parameters, the translation, rotation, and scale parameters are defined **from** the local datum **to** WGS-84.

Figure 5.1 illustrates the change in the coordinate systems.

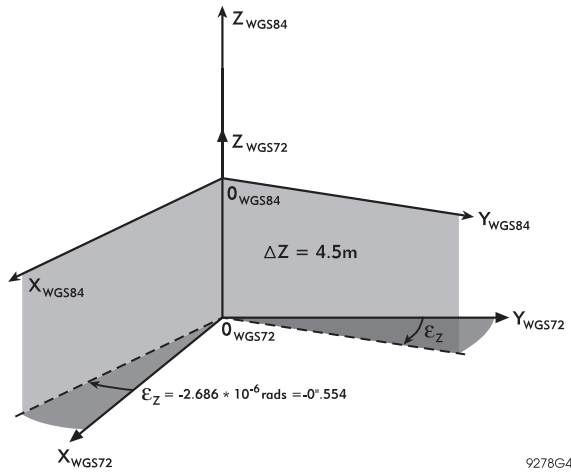



Figure 5.1. Rotation and Translation Between Coordinate Systems

After transforming the datum, the receiver computes geodetic coordinates in the defined system. All coordinates output by the receiver are in this new system.

 Do not forget to issue the \$PASHS,DTM,UDD command after defining the transformation parameters with the \$PASHS,UDD command. Otherwise, the newly entered parameters are not used.

Datum to Grid

Use this transformation to generate coordinates in an $\langle x,y \rangle$ rectangular system, based on the user's location and mapping requirements or local standard. You can select any projection along with any base datum for output.

Convert geodetic coordinates into grid coordinates by defining a grid system utilizing one of the supported projection types (Figures 5.2 - 5.6).

CAUTION

Although almost any projection or combination of datums and projections is mathematically possible, some are inappropriate with respect to the project scope or geographic area.

To set the receiver to supply grid coordinates:

1. Select the projection type that best fits your needs.
2. Define the grid system, using this projection type, with the \$PASHS,UDG command. This command defines the grid system to be used.
3. Enable the grid system with the \$PASHS,GRD,UDG command. The receiver computes grid coordinates in the system defined.
4. To access the grid coordinates, use either the \$PASHQ,GDC command to query for one output of the current coordinates, or use the \$PASHS,NME,GDC command to set the receiver to continuously output the current coordinates.

There is one exception when configuring the receiver to compute and output grid coordinates. If you are interested in computing and outputting WGS-84 based UTM coordinates, there is no need to define the grid system in the receiver. The parameters for WGS84 UTM are pre-set in the receiver. To use them, set the receiver to output grid coordinates using either the \$PASHQ,UTM command to query for one output of the current coordinates, or the \$PASHS,NME,UTM command to set the receiver to continuously output the current coordinates.



Check the GDC message for the currently assigned datum.

Projection Types

The following graphics represent the different types of projections available for the receiver.

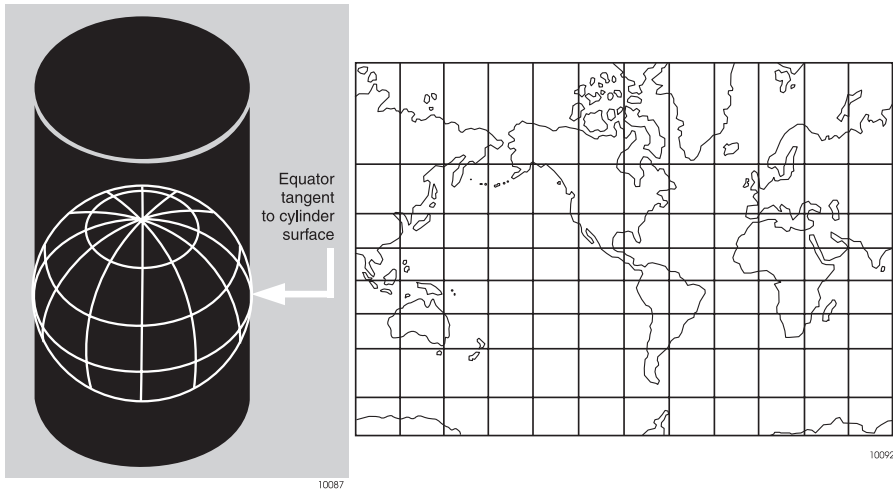
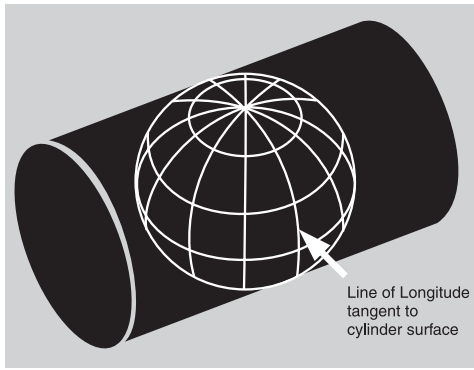
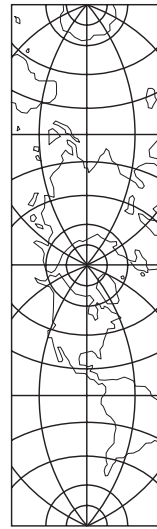

Figure 5.2. Mercator



10088



10094

Figure 5.3. Transverse Mercator

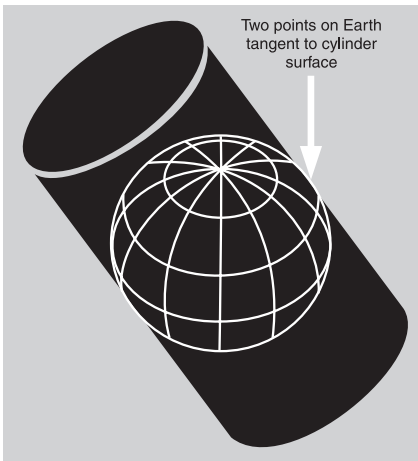

10089

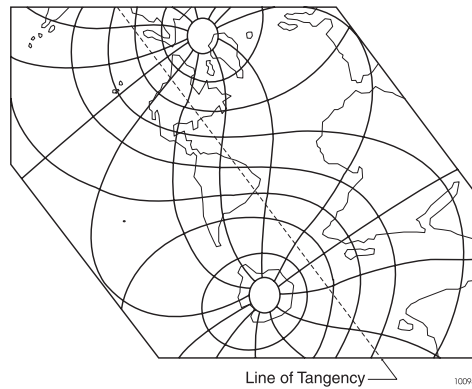

Line of Tangency

10093

Figure 5.4. Oblique Mercator

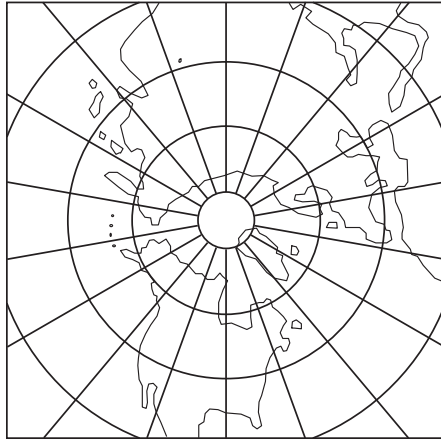
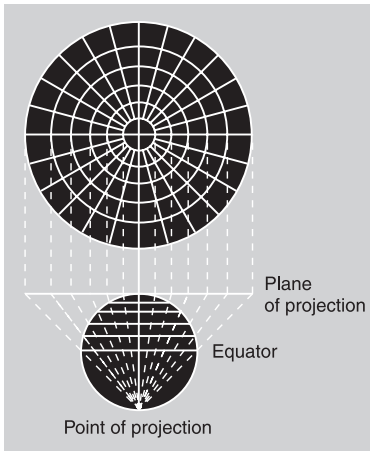

Figure 5.5. Stereographic

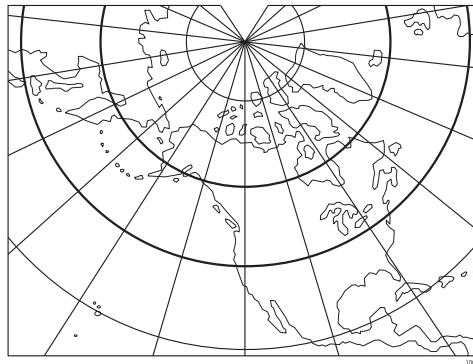
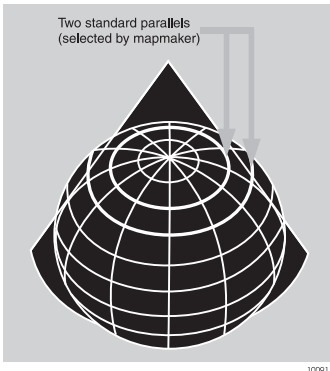

Figure 5.6. Lambert Conformal Conic

Elevation Modeling

In addition to computing and outputting geodetic and cartesian coordinates in different systems, the receiver can compute and output elevations in different systems.

By default, the receiver computes and outputs ellipsoidal heights. In some messages, the geoid separation is included, computed from the internal global model, relative to WGS-84.

To set the receiver to compute and output orthometric heights, use the \$PASHS,HGT,GEO command. After setting this command, the receiver outputs orthometric heights using the internal global geoid model. Be aware that the internal geoid model used in this calculation is very coarse. Orthometric heights derived from this model could be in error by a meter or more.



If separation is included in the message, it is calculated by adding the difference between WGS-84 and a user- or pre-defined datum to the WGS-84-based geoid separation. An exception to this is the GGA message which ONLY outputs WGS-84 based geoid heights and separation, as per NMEA specifications.

6

Command/Response Formats

This chapter details the formats and content of the serial port commands through which the receiver is controlled and monitored. These serial port commands set receiver parameters and request data and receiver status information. Use the RCS (or REMOTE.exe) software or any other standard serial communication software to send and receive messages. Note that the baud rate and protocol of the computer COM port must match the baud rate and protocol of the receiver port for commands and data to be successfully transmitted and received. The receiver protocol is 8 data bits, 1 stop bit, and parity = none.

All commands sent by the user to the receiver are either **Set** commands or **Query** commands. **Set** commands generally change receiver parameters and initiate data output. **Query** commands generally request receiver status information. All set commands begin with the string \$PASHS, and all query commands begin with the \$PASHQ string. \$PASHS and \$PASHQ are the message start character and message header and are required for all commands. All commands must end with <Enter> to transmit the command to the receiver. If desired, an optional checksum may precede <Enter>. All response messages end with <Enter>.

In this manual, the serial commands are discussed in six separate groups:

- **Receiver commands** - general receiver operations - page 83
- **Raw data commands** - measurement, ephemeris, and almanac - page 145
- **NMEA message commands** - NMEA message output - page 181
- **RTCM commands** - RTCM differential operation - page 242
- **CPD commands** - carrier phase differential (CPD) operation - page 253

- **UCT commands** - coordinate transformation, map projection - page 278

Within each group, the commands are listed alphabetically and then described in detail. Information about the command including the syntax, a description, the range and default, and an example of how it is used are presented for each command. The syntax includes the number and type of parameters that are used or required by the command; these parameters may be characters or numbers, depending upon the particular command. The parameter type is indicated by the symbol that is a part of the syntax. Table 6.1 describes parameter symbology.

Table 6.1. Command Parameter Symbols

Symbol	Parameter Type	Example
d	Numeric integer	3
f	Numeric real	2.45
c	1 character ASCII	N
s	character string	OFF
m	mixed parameter (integer and real) for lat/lon or time	3729.12345
h	hexadecimal digit	FD2C
*cc	hexadecimal checksum which is always preceded by a *	*A5
<Enter>	Combination of <CR><LF> (carriage return, line feed, in that order)	

For example, for the receiver command:

\$PASHS,RCI,f <Enter>

The parameter **f** indicates that the RCI command accepts a single parameter that is a real number such as 0.5 or 10.0. If a character is entered instead, the command will be rejected. Generally speaking, the parameter must be in the specified format to be accepted. However, most parameters that are real numbers (**f**) will also accept an integer. For example, in the case of the RCI command, both 10 and 10.0 are accepted by the receiver.

Receiver Commands

Receiver commands change or display various receiver operating parameters such as recording interval, antenna position, and PDOP mask. Commands may be sent through any available serial port.

Set Commands

The general structure of the set commands is:

```
$PASHS,s,c <Enter>
```

where *s* is a 3-character command identifier, and *c* is one or more data parameters that will be sent to the receiver. For example, the set command to change the recording interval to 5 seconds is:

```
$PASHS,RCI,5 <Enter>
```

If a set command is accepted, an acknowledgment message is returned in the form:

```
$PASHR,ACK*3D
```

If a set command is not accepted, a non-acknowledgment message is returned in the form `$PASHR,NAK*30`. If a command is not accepted, check that the command has been typed correctly, and that the number and format of the data parameters are correct.

Query Commands

The general structure of the query command is:

```
$PASHQ,s,c <Enter>
```

where *s* is a 3-character command identifier and *c* is the serial port where the response message will be sent. The serial port field is optional. If the serial port is not included in a query command, the response will be sent to the current port. For example, if you are communicating with the receiver on Port A and send the following query command:

```
$PASHQ,SES <Enter>
```

The response will be sent to port A. However, if from the same port, you send the query command:

```
$PASHQ,SES,B <Enter>
```

Then the response will be sent to port B.

The format of the response message may either be in a comma-delimited format or in a free-form table format, depending upon the query command. Note that not every set command has a corresponding query command. The most useful query command to check the general status of most receiver parameters is:

\$PASHQ,PAR <Enter>

Table 6.2 lists the receiver commands alphabetically by function, and then alphabetically within each function. Each command is described in detail in alphabetical order in the pages following the table.

Table 6.2. Receiver Commands

Command	Description	Page
ANTENNA POSITION		
\$PASHS,ALT	Set ellipsoidal height of antenna	88
\$PASHS,POS	Set position of antenna	119
DATA RECORDING		
\$PASHS,DOI	Sets raw data output interval	94
\$PASHS,DRI	Sets PCMCIA card data recording interval	95
\$PASHS,DSC	Store event or attribute string	95
\$PASHS,ELM	Set recording satellite elevation angle mask	96
\$PASHS,EPG	Sets the epoch counter for kinematic survey	96
\$PASHS,MSV	Sets minimum number of Svs for recording	113
\$PASHS,RCI	Set data recording interval	125
\$PASHS,REC	Enable/disable data recording/raw data output interval	125
\$PASHS,RNG	Set data recording type	127
DILUTION OF PRECISION (DOP)		
\$PASHS,HDP	Set HDOP mask for position computation	100
\$PASHS,PDP	Set PDOP mask for position computation	117
\$PASHS,VDP	Set VDOP mask for position computation	139
PCMCIA CARD/FILE MANAGEMENT		
\$PASHS,CLM	Clear (reformat) PCMCIA Card	92
\$PASHS,FIL,C	Close current data file	96
\$PASHS,FIL,D	Delete data files	97
\$PASHQ,FLS	Query data file information	97

Table 6.2. Receiver Commands (continued)

Command	Description	Page
IONOSPHERE		
\$PASHS,ION	Include/exclude ionospheric model	106
\$PASHQ,ION	Display ionosphere data information	106
MEMORY		
\$PASHS,INI	Clear internal memory and/or PCMCIA Card	104
\$PASHS,RST	Reset receiver to default parameters	127
\$PASHS,SAV	Save parameters in battery-backed-up memory	128
METEOROLOGICAL METER		
\$PASHR,MET	Query meteorological meter setup	111
\$PASHS,MET,CMD	Set meteorological meter trigger string	111
\$PASHS,MET,INIT	Set meteorological meter initialization string	112
\$PASHS,MET,INTVL	Set meteorological meter output interval	112
\$PASHS,OUT,c,MET	Start/Stop output of meteorological meter data	113
MISCELLANEOUS PARAMETERS		
\$PASHQ,TMP	Query receiver temperature	138
\$PASHS,WAK	Acknowledge warning messages	139
\$PASHQ,WKN	Query GPS week number	144
\$PASHQ,WARN	Query warning messages	139
PHOTOGRAMMETRY/1PPS/STROBE		
\$PASHS,PHE	Set photogrammetry edge (event marker)	117
\$PASHQ,PHE	Display the photogrammetry parameters	117
\$PASHS,PPS	Set period and offset of 1PPS signal	122
\$PASHQ,PPS	Display 1PPS parameters	123
POSITION COMPUTATION		
\$PASHS,FIX	Set altitude hold position fix mode	97
\$PASHS,PEM	Set elevation mask for position computation	117
\$PASHS,SEM	Set secondary elevation mask	128
\$PASHS,PMD	Set position computation mode	119
\$PASHS,PPO	Set point positioning mode	122
\$PASHS,UNH	Omit/include unhealthy satellites for position computation	139

Table 6.2. Receiver Commands (continued)

Command	Description	Page
POWER/BATTERY PARAMETERS		
\$PASHS,POW	Set battery parameters	121
\$PASHQ,POW	Query battery parameters	121
\$PASHS,PWR	Put receiver to sleep	125
RECEIVER CONFIGURATION		
\$PASHS,BEEP	Enable/Disable LED and warning beep	92
\$PASHQ,BEEP	Query LED and Warning beep setting	92
\$PASHS,CTS	Enable/disable hardware handshake	94
\$PASHQ,CTS	Query hardware handshake status	94
\$PASHS,DSY	Configure serial ports as daisy chain	95
\$PASHS,LPS	Set loop parameters	108
\$PASHQ,LPS	Query loop parameter settings	108
\$PASHS,LTZ	Set local time zone	108
\$PASHS,MDM	Set modem parameters	109
\$PASHS,MDM,INI	Initialize modem communication	110
\$PASHQ,MDM	Query modem parameters	110
\$PASHQ,PAR	Request current settings of receiver parameters	114
\$PASHQ,PRT	Query port setting	123
\$PASHQ,RAW	Request port baud rate	175
\$PASHQ,RID	Request receiver data recording settings	126
\$PASHQ,SID	Request receiver identification	133
\$PASHS,SPD	Query receiver serial number	134
\$PASHS,TST	Set baud rate of serial port	138
SATELLITE INFORMATION		
\$PASHQ,ALH	Query the almanac messages received	88
\$PASHQ,CSN	Query satellite signal-to-noise ratios	93
\$PASHR,CSN	Satellite signal-to-noise response message	93
\$PASHQ,STA	Request status of SVs currently locked	135
\$PASHS,SVS	Designate satellites to track	135
\$PASHS,USE	Designate individual satellites to track	139

Table 6.2. Receiver Commands (continued)

Command	Description	Page
SESSION PARAMETERS		
\$PASHS,INF	Set session parameters	100
\$PASHQ,INF	Query session parameters	102
\$PASHS,PJT	Log project data	118
SESSION PROGRAMMING		
\$PASHS,SES,PAR	Set session programming parameters	129
\$PASHS,SES,SET	Set individual sessions	130
\$PASHS,SES,DEL	Clear session programming parameters and reset to default	130
\$PASHQ,SES	Query session programming parameters	130
SURVEY		
\$PASHS,ANA	Antenna height after survey	88
\$PASHS,ANH	Antenna height before survey	89
\$PASHS,ANR	Antenna reduction setting	89
\$PASHS,ANT	Set antenna offsets	90
\$PASHQ,ANT	Query antenna offset parameters	90
\$PASHS,MST	Set minimum number of satellites for kinematic survey.	112
\$PASHS,SIT	Enter site name	134
TILTMETER		
\$PASHS,TLT,CMD	Set tiltmeter trigger string	136
\$PASHS,TLT,INIT	Set tiltmeter initialization string	137
\$PASHS,TLT,INTVL	Set tiltmeter ouput interval	137
\$PASHS,OUT,c,TLT	Start/stop output of tiltmeter data	113
\$PASHQ,TLT	Query tiltmeter setup	136

ALH: Almanac Messages Received

\$PASHQ,ALH,c

This command queries the receiver for the number of almanac messages that have been received since the last power cycle, where c is the optional output port. Using this query, a user can tell when all of the most recent almanac messages have been received.

Example: Query the current port for the number of received almanac messages.

```
$PASHQ,ALH <Enter>
```

\$PASHR,ALH

The response message is in the form shown below and described in Table 6.3.

```
$PASHR,ALH,d1,s1*cc <Enter>
```

Table 6.3. ALH Parameter Table

Parameter	Significance	Range
d1	Number of almanac messages received since power up	0-32
s1	All almanac messages received NO = not all almanacs have been received OK = all almanacs received	NO OK
*cc	checksum	

ALT: Set Ellipsoid Height

\$PASHS,ALT,f

Sets the ellipsoidal height of the antenna, where f = ± 99999.999 meters. The receiver uses this data in the position calculation for 2-D position computation, and when in differential base mode.

Examples:

Set ellipsoidal height of antenna to 100.25 meters.

```
$PASHS,ALT,100.25 <Enter>
```

Set ellipsoidal height of antenna to -30.1m.

```
$PASHS,ALT,-30.1 <Enter>
```

ANA: Post-Survey Antenna Height

\$PASHS,ANA,f

Sets the antenna height after survey, where f is from 0.0 - 64.0000 meters. This command is used to record the antenna height after a survey, as a check to verify

the original antenna height.

Example: Set after-survey antenna height to 3.5343 meters:

```
$PASHS,ANA,3.5343 <Enter>
```

ANH: Set Antenna Height

\$PASHS,ANH,f

Sets the antenna height where f is from 0.0 - 64.0000 meters.

Example: Set antenna height to 3.534 meters.

```
$PASHS,ANH,3.534 <Enter>
```

ANR: Set Antenna Reduction Mode

\$PASHS,ANR,s

Sets the antenna reduction mode. The mode selection is used to translate between ground mark position and antenna phase center position.

When turned on, this mode applies the antenna parameters entered via \$PASHS,ANT to the computed position to make it the ground mark position. This implies that the base position entered should also be the ground mark position of the base.

When turned off, the parameters entered via \$PASHS,ANT are ignored and the position is the position of the phase center of the antenna. This implies that the base position entered should also be the one of the phase center of the base antenna.

Table 6.4. ANR Message Structure

Parameter	Description	Range
s	Reduction mode	ON => Antenna reduction on ALL position messages for autonomous, code differential, and RTK. OFF => No antenna reduction in ANY position messages for autonomous, code differential, and RTK. CPD => No antenna reduction on for position messages for autonomous and code differential, but RTK has antenna reduction. (default to be compatible with UB00)

Example: Set antenna reduction mode to CPD only:

```
$PASHS,ANR,CPD <Enter>
```



Antenna reduction, when performed, is applied to ALL position messages except for PBN and the position in the B-file. For more detail on the usage of the antenna reduction mode, see *Base Station Antenna Offset* in Z-family manual.

ANT: Set Antenna Offsets

\$PASHS,ANT,f1,f2,f3,m1,f4

Sets the antenna offsets from ground mark to antenna phase center via a reference point. Horizontally, the reference point is the physical center of the antenna housing. Vertically, the reference point is the point to which the antenna slant height was measured. The antenna phase center is the center of reception of the signal. Table 6.5 summarizes the various offsets.

Table 6.5. Antenna Offsets Settings

Parameter	Description	Range	Unit
f1	Antenna slant height: height measured from the reference point to the antenna edge	0 -64.000	Meter
f2	Antenna radius: the distance from the reference point to the antenna edge	0.0 - 9.9999	Meter
f3	Antenna vertical offset: the offset from the antenna phase center to the reference point	0.0 - 99.9999	Meter
m1	Horizontal azimuth: measured from reference point to antenna phase center, with respect to WGS84 north (dddmm.mm)	35959.99	Degrees decimal minutes
f4	Horizontal distance: measured from reference point to point below (above) antenna phase center.	999.9999	Meter

Example: Set antenna offsets.

```
$PASHS,ANT,1.678,0.1737,0.5,0,0 <Enter>
```

\$PASHQ,ANT,c

Requests the current antenna offset parameters, where c is the output port and is not required to direct the response message to the current communication port.

Example: \$PASHQ,ANT <Enter>

\$PASHR,ANT,f1,f2,f3,m1,f4*cc

Returns the antenna parameters of the receiver, where Table 6.6 defines the message structure.

Table 6.6. ANT Message Structure

Parameter	Description	Unit
f1	Antenna height: height measured from reference point to antenna edge	meter
f2	Antenna radius: distance from antenna phase center to antenna edge	meter

Table 6.6. ANT Message Structure (continued)

Parameter	Description	Unit
f3	Antenna offset: offset from antenna phase center to antenna ground plane edge	meter
m1	Horizontal azimuth: measured from reference point to antenna phase center, with respect to WGS84 north (dddmm.mm)	degree and decimal minutes
f4	Horizontal distance: measured from reference point to point below (above) antenna phase center.	meter
*cc	Checksum	n/a

BEEP: Beeper Set-up

\$PASHS,BEEP,s

This command enables or disables the audible beeper, where s is ON or OFF. If the beeper is disabled, it will not sound when a warning is generated. The beeper is ON by default in Z-Xtreme, Z-Surveyor and FX, and OFF by default in Z-Sensor. Z-Eurocard doesn't have a beeper. The status is saved in battery-backed memory if \$PASHS,SAV,Y has been issued afterwards.

Example: Disable the beeper.

```
$PASHS,BEEP,OFF <Enter>
```

\$PASHQ,BEEP,c

Requests the current state of the beeper, where c is the optional output port and is not required to direct the response to the current port.

\$PASHR,BEEP

The response message is in the form \$PASHR,BEEP,s where s is the beeper status, ON or OFF.

CLM: Clear/Reformat PCMCIA Card

\$PASHS,CLM

The CLM command deletes all files from the data card and reformats all tracks in the data card. This includes the File Allocation Table (FAT), directory structure, and data area.

 To avoid fragmentation of the card which can occur over time, it is recommended that the CLM command be performed at least once a week.

Example: Clear data files from PCMCIA card.

```
$PASHS,CLM <Enter>
```

\$PASHQ,CLM,c

This command queries the status the PCMCIA data card reformatting initiated with either a \$PASHS,CLM command or a \$PASHS,INI command (reset memory code = 2 or 3), where c is the optional output port.

Example: Check the status of the PC card reformatting:

```
$PASHQ,CLM<Enter>
```

\$PASHR,CLM

For the CLM command, the response message depends upon whether a \$PASHS,CLM command or a \$PASHQ,CLM query has been sent.

If \$PASHQ,CLM has been sent, the response is:

\$PASHR,CLM,d1*cc, where d1 is the percent of reformatting completed, and ranges from 0 to 100.

If the set command \$PASHS,CLM has been sent, the response is as follows:

If the card passes the test, the response is in the form:

\$PASHR,CLM,WAIT*cc <Enter>

\$PASHR,CLM,SIZE,d1KB*cc <Enter>

\$PASHR,CLM,PASSED*cc <Enter>

If the card fails the test, the response is in the form:

\$PASHR,CLM,FAILED*cc <Enter>

Table 6.7 describes the parameters in the response message.

Table 6.7. CLM Message Structure

Parameter	Significance
d1	Size of the data card in kilobytes
*cc	Checksum



The time to complete the CLM depends up on the data card size: approximately 5 seconds per MB.

CSN: Satellite Signal to Noise

\$PASHQ,CSN

This command queries the receiver for the signal-to-noise ratios (in dB Hz) of all tracked satellites.

Example: Query receiver for CSN message:

\$PASHQ,CSN <Enter>

\$PASHR,CSN

The response message is in the form:

\$PASHR,CSN,m1,d2,d3,n(d4,d5,d6,d7)*cc

where n is equal to d2, and where parameters s5,d6, and c7 are repeated 9 times, once for each raw data message type.

Table 6.8 describes each parameter in the CSN message.

Table 6.8. CSN Message Structure

Parameter	Description	Range
m1	GPS time (hhmmss.ss)	0-235959.50

Table 6.8. CSN Message Structure (continued)

Parameter	Description	Range
d2	Number of SVs locked	0 - 12
d3	Number of ratios per satellite	1 - 3
d4	PRN number	0 - 32
d5	C/A s/n ratio (dB Hz)	
d6	L1 s/n ratio (dB Hz)	
d7	L2 s/n ratio (dB Hz)	
*cc	checksum	

CTS: Port Protocol Setting

\$PASHS,CTS,c,s

This command enables or disables the RTS/CTS (handshaking) protocol for the specified port, where c is the port and s is ON or OFF. If the port is not specified (i.e., if c is not included in the command), the protocol is enabled or disabled for the port to which the command was sent.

Example: Disable the handshaking protocol for port A:

```
$PASHS,CTS,A,OFF <Enter>
```

\$PASHQ,CTS,c

Query the RTS/CTS (handshaking) protocol status, where c is the optional output port and is not required to direct the response to the current port.

\$PASHR,CTS,s

CTS response message, where s is ON or OFF.

DOI: Data Output Interval

\$PASHS,DOI,f1

Sets the output rate of raw data through the serial port, where f1 is any value between 0.1 and 999 seconds. The default is 20.0 seconds. Values between 1 second and 999 seconds can only increment in 1 second intervals. For example, 20.1 seconds is not a valid value.

Example: Set the data output interval to 5 seconds:

```
$PASHS,DOI,5<Enter>
```

Setting the \$PASHS,RCI command will override this command. See also the commands \$PASHS,DRI and



\$PASHS,RCL

DRI: Data Recording Interval

\$PASHS,DRI,f1

Sets the recording interval of data to the PCMCIA card, where f1 is any value between 0.1 and 999 seconds. The default is 20.0 seconds. Values between 1 second and 999 seconds can only increment in 1 second intervals. For example, 20.1 seconds is not a valid value.

Example: Set the data recording interval to 5 seconds:

```
$PASHS,DRI,5<Enter>
```



Setting the \$PASHS,RCL command will override this command.

DSC: Store Event String

\$PASHS,DSC,s

Store a string as event datum to current open session in receiver, where s is a character string up to 80 characters. The string is stored in the D-file with a time tag.

Example: Set the string 'LightPole' to the receiver:

```
$PASHS,DSC,LIGHTPOLE <Enter>
```

DSY: Daisy Chain

\$PASHS,DSY,c1,c2 or \$PASHS,DSY,OFF

Redirects all characters from one serial port to another without interpreting them, where c1 is the source port, and c2 is the destination port. Any combination may be chosen. This command is used primarily to initialize the radio from an external monitor (handheld or PC). When a port is in daisy chain mode, it can only interpret the OFF command; all other characters are redirected. The OFF command discontinues the daisy chain mode. Redirection can also be bi-directional (i.e. A to B and B to A at the same time), but a second command is necessary to set the other direction. Table 6.9 summarizes the source and destination ranges.

Table 6.9. DSY Parameter Table

Parameter	Description	Range
c1	Source port	A...D
c2	Destination port	A...D

Example: Redirects A to B. Can issue from any port.

```
$PASHS,DSY,A,B <Enter>
```

Redirects B to A. Can issue from any port, but it cannot be issued from port A if \$PASH,DSY,A,B <Enter> has been sent.

```
$PASHS,DSY,B,A <Enter>
```

Turns off redirection from A. Can issue from any port.

```
$PASHS,DSY,A,OFF <Enter>
```

Turns off daisy chain on all ports. Can issue from any port.

```
$PASHS,DSY,OFF <Enter>
```

ELM: Recording Elevation Mask

\$PASHS,ELM,d

Sets elevation mask for position computation, where d1 is the primary position elevation mask, and d2 is an optional zenith position elevation mask. Both d1 and d2 may be set to any value between 0 and 90 degrees, although d1 must be less than d2. The default for the primary position elevation mask is 10 degrees. The default for the zenith position elevation mask is 90 degrees.

Example: Set primary position elevation mask to 15 degrees

```
$PASHS,ELM,15 <Enter>
```

Example: Set primary position elevation mask to 15 degrees, and zenith position elevation mask to 80 degrees:

```
$PASHS,ELM,15,80 <Enter>
```

EPG: Epoch Counter

\$PASHS,EPG,d

Sets the initial value of the counter of epochs for recording at a site where d is the number of epochs and ranges from 0 to 999. The command is used during kinematic surveys, when the user occupies a site for a set amount of time. When the number of epoch goes to zero, the site name will be set to ???? automatically indicating that the receiver is in motion.

Example: Set epoch counter to 20:

```
$PASHS,EPG,20 <Enter>
```

FIL,C: Close a File

\$PASHS,FIL,C

Closes the current file in the receiver.

Example: Close current file in receiver:

```
$PASHS,FIL,C <Enter>
```



If a file closure is attempted while the file system is mounting, the receiver will respond with a \$PASHR,FIL,BUSY message and the file will not be closed.

FIL,D: Delete a File

\$PASHS,FIL,D,d

Delete data file(s) from the receiver, where d is the file index number, and ranges from 0 - 99. If d is 999 then all files are deleted and the PC card is reformatted.

If the deleted file is not the last file in the receiver, the receiver reorders all files after the deleted file, thus changing the file index numbers for those files.

Example: Delete 6th file from receiver.

```
$PASHS,FIL,D,5 <Enter>
```



Command \$PASHS,FIL,D,999 not only deletes all files, but also reformats the PCMCIA card by clearing the FAT and directory structure.

FIX: Altitude Fix Mode

\$PASHS,FIX,d

Set altitude hold position fix mode for the altitude used (for 2-D position determination), where d is 0 or 1. The default is 0. This command must be used with the \$PASHS,PMD command.

Table 6.10. FIX Parameter Settings

Parameter	Description
d = 0	(default) the most recent antenna altitude is used in altitude hold position fix. The altitude is taken from either the altitude entered by the \$PASHS,ALT command, or the last one computed when VDOP is less than VDOP mask.
d = 1	always use the altitude entered by \$PASHS,ALT command.

Example: Fix altitude to always use the entered altitude.

```
$PASHS,FIX,1 <Enter>
```

FLS: Receiver File Information

\$PASHQ,FLS,d

This command requests file information from the memory card, where d is the beginning file index number and can range from 0 - 99. The file index number is a sequence number where the first file has a file index = 0, the second file has a file index = 1, and continuing through to the 100th file which has a file index number of 99.

The output displays files in blocks of up to 10 files. If d is greater than the highest file index number, then the command will not be acknowledged (NAK is returned).

Example: Display file information for files 1-10.

```
$PASHQ,FLS,0 <Enter>
```

Display file information for files 6-15.

```
$PASHQ,FLS,5 <Enter>
```

 If a file closure is attempted while the file system is mounting, the receiver will respond with a \$PASHR,FIL,BUSY message until the mounting procedure is complete.

\$PASHR,FLS

The response returns file size, name, and available memory information.

Response:

```
$PASHR,FLS,d1,d2,d3,n(s4,m5,d6) *cc <Enter>
```

Table 6.11. FLS Message Structure

Parameter	Description
d1	Free memory in receiver PCMCIA card in Kbytes.
d2	Total number of files currently in the receiver.
d3	Number of files that match the query parameter and are displayed in the response.
s4	File 4 character site name.
m5	Time of last epoch recorded in the file, in the format wwwwdhmm where: www = the GPS week number d = day in the week (1-7) hhmm = hours and minutes
d6	Size of the file in Kbytes
*cc	checksum

n = number of files displayed (f3)

Example:

```
$PASHR,FLS,000003,003,03,SIT1,095641850,001666,SIT2,095721707,000187,SIT3,095721803,000051*2A <Enter>
```

Table 6.12. Typical FLS Message

Item	Significance
000003 003 03	3 kb left on the Pc card (i.e., Pc card is full) 3 sessions total on the card 3 sessions listed in the message
SIT1 095641850 001666	Site name of 1st session listed GPS week 0956, day 4 (Wednesday) at 18:50 (6:50 pm) 1.666 MByte of data on that session
SIT2 095721707 000187	Site name of the 2nd session listed GPS week 0957, day 2 (Monday) at 17:07 (5:07 pm) 187 KByte of data on that session
SIT3 095721803 000051	Site name of 3rd session listed GPS week of 0957, day 2 (Monday) at 18:03 (6:03 pm) 51 KByte of data on that session
2A	checksum

FSS: File System Status

\$PASHQ,FSS,c

This command queries the status of PCMCIA data card where *c* is the optional output port. This command can be used to check the file system mounting progress when a new data card is inserted in the receiver, as well as the number of files on the card and which file is currently active.

Example: Query file system status and direct output to port B:

```
$PASHQ,FSS,B <Enter>
```

\$PASHR,FSS

The FSS response message returns the number of files on the disk, the index number of the currently active file, and percent completion of the file system mounting, plus some reserved parameters for internal use only. The response is in the form:

```
$PASHR,FSS,h1,d2,d2,d3,d4,d5,d6*cc
```

where the parameters are as defined in Table 6.13.

Table 6.13. FSS Message Structure

Parameter	Description	Range
h1	Reserved	4-digit hex
d2	Reserved	2 digit
d3	Reserved	2 digit
d4	File index of current active file (999 = no file active)	0-099, 999
d5	Total number of files on the PC card	001-100
d6	File system mounting status (% complete)	0-100
*cc	Checksum	

HDP: HDOP Mask

\$PASHS,HDP,d

Set value of HDOP mask, where d is a number between 0 and 99 (default =4).

Example: Set HDOP mask to 6:

\$PASHS,HDP,6 <Enter>

INF: Set Session Information

\$PASHS,INF,c1,s2,s3,s4,s5,s6,f7,d8,d9,d10,d11

Sets a variety of session information parameters.

Table 6.14. INF Parameter Table

Parameter	Description	Range
c1	Session name	1 alphanumeric char
s2	Receiver serial number	3 alphanumeric char
s3	Antenna serial number	3 alphanumeric char
s4	Month and Day of the session (mmdd)	01-12 month 01-31 day
s5	Operator identification,	3 alphanumeric characters
s6	User comment	up to 9 alphanumeric characters

Table 6.14. INF Parameter Table

Parameter	Description	Range
f7	Antenna height in meters	0.0000 - 64.0000
d8	Dry temperature in degrees Celsius	-99 - +99
d9	Wet temperature in degrees Celsius	-99 - + 99
d10	Relative humidity in percent	0 - 99
d11	Barometric pressure in millibars	0 - 9999

Example: Set session parameters

```
$PASHS,INF,A,325,401,0313,DWK,Test-Proj,1.456,65,60,65,1010 <Enter>
```

\$PASHQ,INF,c

Query the survey session parameters, where c is the optional output port.

Example: Query session parameters to the current port.

```
$PASHQ,INF <Enter>
```

\$PASHR,INF

The response message is in the form:

```
$PASHR,INF,f1,d2,d3,d4,c5,d6,d7,s8,c9,s10,s11,s12,s13,s14,f15,d16,  
d17,d18,d19,f20,d21,d22,d23,d24 *cc <Enter>
```

Where Table 6.15 outlines the response format.

Table 6.15. INF Message Structure

Return Parameter	Description	Range
f1	Data recording interval in seconds	0.1 - 999
d2	Minimum number of SV for data recording	0 - 9
d3	Satellite elevation angle mask for data recording	0 - 90
d4	Data type recorded	0, 2, 4
c5	Recording data switch	Y or N
d6	Minimum number of SV for kinematic alarm	0, 4 - 9
d7	Number of epochs to go for kinematic survey	0 - 999
s8	Site name	4 alpha-numeric characters
c9	Session name	1 alpha-numeric character
s10	Receiver number	3 alpha-numeric character
s11	Antenna number	3 alpha-numeric character
s12	Month and Day of the session (mmdd)	1 - 12 month/1 - 31 day
s13	Operator identification	3 alpha-numeric character
s14	User comment	9 alpha-numeric character
f15	Antenna height before data collection	0.0000 - 64.0000

Table 6.15. INF Message Structure (continued)

Return Parameter	Description	Range
d16	Dry temperature before data collection (degrees celsius).	±99
d17	Wet temperature before data collection (degrees celsius)	±99
d18	Relative humidity before data collection (percent)	0 - 99
d19	Barometric pressure before data collection (millibars)	0 - 9999
f20	Antenna height after data collection (meters)	0.0000 - 64.0000
d21	Dry temperature after data collection (degrees celsius)	±99
d22	Wet temperature after data collection (degrees celsius)	±99
d23	Relative humidity after data collection (percent)	0 - 99
d24	Barometric pressure after data collection (millibars)	0 - 9999
*cc	Checksum	

INI: Receiver Initialization

\$PASHS,INI,d1,d2,d3,d4,d5,c6

The INI command resets the receiver memory, sets the serial port baud rate to the specified rates, and/or sends the modem initialization string through the specified port.

Table 6.16. INI Parameter Description Table

Parameter	Description	Range*	Default
d1	Port A baud rate code	0-9	5
d2	Port B baud rate code	0-9	5
d3	Port C baud rate code	0-9	5
d4	Port D baud rate code	0-9	5
d5	Reset Memory Code	0-3	n/a
c6	Modem initialization Port, 0 = No initialization	A-D, 0	n/a

* Refer to Table 6.17 for baud rate and Table 6.18 for reset memory codes.

Table 6.17. Baud Rate Codes

Code	Baud Rate	Code	Baud Rate
0	300	5	9600
1	600	6	19200
2	1200	7	38400
3	2400	8	57600
4	4800	9	115200

Table 6.18. Reset Memory Codes

Reset Memory Code	Action
0	No memory reset
1	Reset internal memory/battery back-up memory

Table 6.18. Reset Memory Codes

Reset Memory Code	Action
2	Reset/reformat PCMCIA card
3	Reset internal memory and PCMCIA card



The Reset Memory Codes 0 and 2 behave like a power cycle. Any parameters not saved with the \$PASHS,SAV command are lost. Code 1 and 3 reset all parameters to default as well as the ephemeris and almanac (i.e., creates a cold start). Code 2 and 3 reformat the data card by clearing the FAT table and directory structure.

ION: Set Ionospheric Model

\$PASHS,ION,c

Enable or disable the ionospheric model to compensate for ionospheric and tropospheric delay in the position computation, where c is either N (disable) or Y (enable). Default is N (disable).

Example: Enable ionospheric model:

```
$PASHS,ION,Y <Enter>
```

ION: Query Ionospheric Parameters

\$PASHQ,ION,c

Query current ionosphere data information through port c, where c is the optional output port and is not required to direct the response message to the current communication port.

The ionosphere data is not computed by the receiver. It is obtained from the frame data transmitted by the satellites.

Example: Query the ionosphere parameters to port C.

```
$PASHQ,ION,C <Enter>
```

\$PASHR,ION

Ionosphere and GPS-to-UTC data conversion parameters. See ICD-GPS-200 for the definition and the description of the model.

Format: \$PASHR,ION,<ION Structure> <Enter>

where Table 6.19 outlines the response structure.

Table 6.19. ION Message Structure

Type	Size (Bytes)	Contents
float	4	$\alpha 0$. Ionospheric parameter(seconds)
float	4	$\alpha 1$. Ionospheric parameter (sec. per semicircle)
float	4	$\alpha 2$. Ionospheric parameter (sec. per semicircle)
float	4	$\alpha 3$. Ionospheric parameter (sec. per semicircle)

Table 6.19. ION Message Structure

Type	Size (Bytes)	Contents
float	4	$\beta 0$. Ionospheric parameter (seconds)
float	4	$\beta 1$. Ionospheric parameter (sec. per semicircle)
float	4	$\beta 2$. Ionospheric parameter (sec. per semicircle)
float	4	$\beta 3$. Ionospheric parameter (sec. per semicircle)
double	8	A1. First order terms of polynomial
double	8	A0. Constant terms of polynomial
unsigned long	4	tot. Reference time for UTC data
short	2	Wnt. UTC reference week number
short	2	Δt_{LS} . GPS-UTC differences at reference time
short	2	WNLSF. week number when leap second became effective
short	2	DN. day number when leap second became effective
short	2	Δt_{LSF} . Delta time between GPS and UTC after correction
short	2	WN. GPS week number
unsigned long	4	tow. Time of the week (in seconds)
short	2	bulwn. GPS week number when message was read
unsigned long	4	bultow. Time of the week when message was read
short	2	Word checksum
total =	76	

LPS: Loop Tracking

\$PASHS,LPS,d1,d2,d3

Set user-selectable third-order loop tracking parameters, where d1 is the 3rd order ratio of the carrier loop, d2 is the carrier loop parameter, and d3 is the code loop parameter (see \$PASHR,LPS below for more information). Loop setting allows the user to select the tracking loop parameters based on the application. The receiver uses default values until another setting is selected. The user settings are saved in battery-backed memory if the \$PASHS,SAV,Y command is issued afterwards and are used until a new setting is selected, or the memory is cleared. The default is 1, 2, 3.

Table 6.20. LPS Message Structure

Parameter	Description	Range
d1	3rd order loop ratio	00 - 10 0 - 2nd order only 1 - ratio of 0.1 (low acceleration) 10 - ratio of 1 (high acceleration)
d2	Carrier loop parameter (related to the noise bandwidth of the loop)	1 - $\omega_0 = 10$ Hz (static) 2 - $\omega_0 = 25$ Hz (low dynamics) 3 - $\omega_0 = 50$ Hz (high dynamics)
d3	Code loop parameter (related to the noise bandwidth of the loop)	1 - $\omega_0 = 0.05$ Hz 2 - $\omega_0 = 0.1$ Hz 3 - $\omega_0 = 0.2$ Hz

Example: Change loop parameters to ratio 0.2 and carrier bandwidth 10 Hz:

```
$PASHS,LPS,2,1,3 <Enter>
```

\$PASHQ,LPS,c

Query tracking loop setting, where c is the optional output port and is not required to direct the response to the current port.

\$PASHR,LPS

The response is in the form:

```
$PASHR,LPS,d1,d2,d3*cc <Enter>
```

where d1-d3 are as described in Table 6.20.

LTZ: Set Local Time Zone

\$PASHS,LTZ,d1,d2

Set local time zone value, where d1 is the number of hours that should be added to the local time to match GMT time and d2 is the number of minutes; minutes

have the same sign as d1. The d1 value is negative for east longitude, and the range is 0 to 13. The setting is displayed by NMEA message ZDA.

Example: Set local time zone to East 7 hours, 20 minutes:

```
$PASHS,LTZ,-7,-20 <Enter>
```

MDM: Set Modem Parameters

\$PASHS,MDM,s1,c2,d3,d4,CFG,s5,MOD,s6,NAM,s7,D2C,s8,C2D,s9

Table 6.21. MDM Setting Parameters and Descriptions

Setting Parameter	Description	Range	Default
s1	Switch to set modem in use flag on or off	"ON"/"OFF"	Off
c2	Serial port that modem connect to	'A' - 'D'	B
d3	Modem type index: 0 - US Robotics Sportster 1 - Telebit WorldBlazer 2 - Telebit TrailBlazer 3 - Telebit CellBlazer 4 - User defined	0 - 4	0
d4 [optional]	Baud Rate Index Code	3 - 8	7
CFG,s5 [optional]	Modem configuration initialization string	96 bytes	
MOD,s6 [optional]	Modem Configuration mode used	16 bytes	
NAM,s7 [optional]	Modem name	40 bytes	
D2C,s8 [optional]	Data to command mode escape string	16 bytes	
C2D,s9 [optional]	Command to data mode string	16 bytes	

Table 6.22. Baud Rate Codes

Code	Baud Rate	Code	Baud Rate
0	300	5	9600
1	600	6	19200
2	1200	7	38400
3	2400	8	57600
4	4800	9	115200



The MDM command is supported only in the ZX-Eurocard receiver.



All s-Parameter optional settings are user defined modem settings and can be entered in any order and with any combination of these settings. If the baud rate index code is not entered, the default baud rate (7=38400) will be used.

Example: Send all parameters for user modem:

```
$PASHS,MDM,ON,B,4,6,CFG,ATS111=255S45=255S51=252S58=250=1&D
2&C1X12E0Q0&W\r\n,MOD,AT&F1\r\n,NAM,US-ROBOTICS, D2C,+++AT,
C2D,ATO\r\n <Enter>
```

Send only mode and data to command escape string and default baud rates:

```
$PASHS,MDM,ON,B,4,MOD,AT&F1\r\n,D2C,+++AT <Enter>
```

\$PASHQ,MDM,c

Query current modem parameter settings, where c is the output port and is not required to direct the response message to the current communication port.

Example: Query modem setting to the current port.

```
$PASHQ,MDM <Enter>
```

\$PASHR,MDM

The return message is in the form shown below and described in Table 6.23.

```
$PASHR,MDM,c1,d2,s3,d4,s5,s6,s7,s8*cc <Enter>
```

Table 6.23. MDM Message Structure

Return Parameter	Description	Range
c1	Receiver port assigned for modem connection	'A' - 'D'
d2	Baud rate code	3 - 8
s3	Modem status	'ON'/'OFF'/'INITOK'/' 'SYNC'/'ESCAPE'
d4	Modem type index	0-4
s5	User defined initialization string	
s6	User defined modem configuration mode	
s7	User defined data to command escape string	
s8	User defined command to data string	
*cc	Byte-wise XOR checksum begin with 'P'	2-byte hex

MDM,INI: Initialize Modem Communication

\$PASHS,MDM,INI

The \$PASHS,MDM,INI command establishes communication between the

modem and the receiver. This command must be run to initiate modem communication after modem parameters have been set using the \$PASHS,MDM command.

Example: Initialize modem communication

```
$PASHS,MDM,INI <Enter>
```

\$PASHR,MDM,INI

If the initialization is successful the response message is in the form:

```
$PASHR,MDM,INI,OK*cc <Enter>
```

If the initialization is not successful, the response message is in the form:

```
$PASHR,MDM,INI,FAIL*cc <Enter>
```



The MDM,INI command is supported only in the ZX-Eurocard receiver.

MET: Meteorological Meters Set-up

\$PASHQ,MET,c

Query meteorological meter setup, where c is the optional output port and is not required to direct the response to the current port.

Response message:

```
MET METER PARAMETERS SETTINGS
```

```

PRTA:OFF INIT_STR:NO      TRIG_CMD:*0100P9      INTVL:0005
PRTB:OFF INIT_STR:NO      TRIG_CMD:*0100P9      INTVL:0005
PRTC:OFF INIT_STR:NO      TRIG_CMD:*0100P9      INTVL:0005
PRTD:OFF INIT_STR:NO      TRIG_CMD:*0100P9      INTVL:0005

```

MET,CMD: Meteorological Meters Trigger String

\$PASHS,MET,CMD,c,s

Set meteorological meters trigger string, where c is the output port and s is the trigger string.

Table 6.24. MET,CMD Message Structure

Parameter	Description	Range
c	Serial port connected to the meteorological meters	A - D
s	trigger string of meteorological meters excluding the starting '*' sign	Limited to 20 alphanumeric characters

Example: Set *9900XY to the MET CMD field:

```
$PASHS,MET,CMD,C,9900XY <Enter>
```

MET,INIT: Meteorological Meters Initialization

\$PASHS,MET,INIT,c,s

Set meteorological meters initialization string.

Table 6.25. MET,INIT Message Structure

Parameter	Description	Range
c	Serial port connected to meteorological meters	A - D
s	Initialization string of meteorological meters excluding the starting '*' sign	limited to 20 alphanumeric characters

Example: Set *9900ID to the INIT STRING_MET field.

```
$PASHS,MET,INIT,A,9900ID <Enter>
```

MET,INTVL : Meteorological Meters Interval

\$PASHS,MET,INTVL,c,d

Set the interval for the query of the meteorological meters.

Table 6.26. MET,INTVL Message Structure

Parameter	Description	Range
c	Serial port connected to meteorological meters	A - D
d	Sample interval for meteorological meters	5-9999 sec (default = 5)

Example: Set 10 to the MET SAMPLE field

```
$PASHS,MET,INTVL,D,10 <Enter>
```

MST: Minimum SVs for Kinematic Survey

\$PASHS,MST,d

Sets the minimum number of satellites required for kinematic survey, where d is that number. If the number of satellites locked is below that minimum, an audible alarm will sound (for a Z-surveyor or Z-FX, a message will be displayed on the LED). The alarm will only disappear if you acknowledge (press any key), not if enough satellites are tracked again.

Example: Set minimum number of satellites to 5:

\$PASHS,MST,5 <Enter>

Table 6.27. MST Parameter Table

Parameter	Description	Range	Default
d	Min. number of satellites required for a kinematic survey. 0 = disable alarm	0, 4 - 9	0

MSV: Minimum SVs for Data Recording

\$PASHS,MSV,d

Sets the minimum number of satellites required for measurement data to be output and/or recorded, where d is a number between 1 and 9. Default is 3.

Example: Set minimum satellites to 4:

\$PASHS,MSV,4 <Enter>

OUT,MET: Start Meteorological Meters Process

\$PASHS,OUT,c,MET,s

Start/stop processing of meteorological meters. The receiver first initializes the meters and then regularly queries them at the interval requested, where c is the port the meteorological meters is connected to, and s is ON or OFF.

Table 6.28. OUT,MET Message Structure

Parameter	Description	Range
c	Serial port connected to meteorological meters.	A - D
s	Enable /disable meteorological meters processing	ON / OFF

Example: Start meteorological meter on port B:

\$PASHS,OUT,B,MET,ON <Enter>

OUT, TLT: Start Tiltmeter Process

\$PASHS,OUT,c,TLT,s

Start/stop the processing of the tiltmeters. The receiver first initializes the meters and then regularly queries them at the interval requested, where c is the port the

tiltmeters is connected to, and s is ON or OFF.

Table 6.29. OUT,TLT Message Structure

Parameter	Description	Range
c	Serial port connected to the tiltmeter	A - D
s	Enable /disable the tiltmeters processing	ON / OFF

Example: Start tiltmeter on port B:

\$PASHS,OUT,B,TLT,ON <Enter>

PAR: Query Receiver Parameters

\$PASHQ,PAR,c

Query general receiver parameters, where c is the optional output port and is not required to direct the response message to the current communication port. This query shows the status of most of the general receiver parameters.

Example: Query the receiver for parameters:

\$PASHQ,PAR <Enter>

The response message is in a table format. A typical response message is:

```
SVS:YYYYYYYYYYYYYYYYYYYYYYYYYYYYYYYYYYYY
PMD:0  FIX:0  ION:N  UNH:N  PDP:40  HDP:04  VDP:04  FUM:N  FZN:01  TAG:ASH
DIF_RTCM MODE: OFF  PRT:A  NMEA_PER:001.0  PEM:10  PPO:N  SAV:N  ANR:CPD
SEM_STA: OFF  SEM:??  FST_AZIM:???  SND_AZIM:???  ZEN_PEM:90
LAT:00:00.0000000N  LON:000:00.0000000W  ALT:+00000.000
NMEA:GLL  GXP  GGA  VTG  GSN  ALM  MSG  DAL  GSA  GSV  TTT  RRE  GRS  UTM  POS  SAT
PRTA:OFF  OFF  OFF  OFF  OFF  OFF  OFF  OFF  OFF  OFF  OFF  OFF  OFF  OFF  OFF  OFF
PRTB:OFF  OFF  OFF  OFF  OFF  OFF  OFF  OFF  OFF  OFF  OFF  OFF  OFF  OFF  OFF  OFF
PRTC:OFF  OFF  OFF  OFF  OFF  OFF  OFF  OFF  OFF  OFF  OFF  OFF  OFF  OFF  OFF  OFF
PRTD:OFF  OFF  OFF  OFF  OFF  OFF  OFF  OFF  OFF  OFF  OFF  OFF  OFF  OFF  OFF  OFF
NMEA:XDR  GDC  RMC  PTT  ZDA  DPO  DCR  CRT  GST
PRTA:OFF  OFF  OFF  OFF  OFF  OFF  OFF  OFF  OFF  OFF
PRTB:OFF  OFF  OFF  OFF  OFF  OFF  OFF  OFF  OFF  OFF
PRTC:OFF  OFF  OFF  OFF  OFF  OFF  OFF  OFF  OFF  OFF
PRTD:OFF  OFF  OFF  OFF  OFF  OFF  OFF  OFF  OFF  OFF
```

Table 6.30 lists all of the above fields in alphabetic order. The description of the

field is given along with the set command to modify them.

Table 6.30. PAR Parameter Table

Return Parameter	Description/Related Command	Range	Unit
ALT	Altitude of antenna \$PASHS,POS or \$PASHS,ALT	±0-99999.999	meter
ANR	Antenna reduction mode \$PASHS,ANR	ON/OFF/CPD	n/a
DIF_RTCM MODE	RTCM differential mode \$PASHS,RTC	OFF BAS (Base) REM (Remote)	n/a
FIX	Altitude hold fix mode \$PASHS,FIX	0, 1	n/a
FST_AZIM	First azimuth setting of secondary elevation mask' \$PASHS,SEM	0 - 360	degree
FUM	Fix UTM zone \$PASHS,FUM	Y/N	n/a
FZN	UTM zone held fixed \$PASHS,FZN	1-60	n/a
HDP	Horizontal Dilution Of Precision mask \$PASHS,HDP	0 - 99	n/a
ION	Enable ionospheric and tropospheric model. \$PASHS,ION	Y/N	n/a
LAT	Latitude of the antenna position \$PASHS,POS	0 - 90 N/S	degree -minute
LON	Longitude of the antenna position \$PASHS,POS	0 - 180 E/W	degree -minute
NMEA	NMEA message type for output		n/a
PDP	Position Dilution of Precision mask \$PASHS,PDP	0 -99	n/a
PEM	Position elevation mask. \$PASHS,PEM	0 - 90	degree
NMEA_PER	NMEA message output period \$PASHS,NME,PER	0.1 - 999	second
PMD	Position mode for the minimum number of satellites required to compute a position fix. \$PASHS,PMD	0 - 3	n/a
PPO	Point Positioning \$PASHS, PPO	Y/N	n/a

Table 6.30. PAR Parameter Table (continued)

Return Parameter	Description/Related Command	Range	Unit
PRTA, PRTB, PRTC, PRTD	Output to port A/B/C/D \$PASHS,NME	ON, OFF	n/a
PRT	Port sending or receiving differential corrections \$PASHS,RTC	A - D	n/a
SAV	Save parameters in the battery-backed-up memory. \$PASHS,SAV	Y/N	n/a
SEM	Secondary elevation mask \$PASHS,SEM	0 - 90 ?? when SEM_STA = OFF	n/a
SEM_STA	Secondary elevation mask \$PASHS,SEM	ON, OFF	n/a
SND_AZIM	Second azimuth setting of secondary elevation mask	0 - 360	degree
SVS	Satellites which the receiver will attempt to acquire \$PASHS,SVS	Y/N	n/a
TAG	NMEA format setting \$PASHS,TAG	ASH, V23, V30	
UNH	Use unhealthy satellites for position computation. \$PASHS,UNH	Y/N	n/a
VDP	Vertical Dilution Of Precision (VDOP) mask \$PASHS,VDP	0 - 99	n/a
ZEN_PEM	Zenith elevation mask setting of position elevation mask \$PASHS,PEM	0 - 90	degree

PDP: PDOP Mask

\$PASHS,PDP,d

Set the value of the PDOP mask to d, where d is a number between 0 and 99. Position is not computed if the PDOP exceeds the PDOP mask. The default is 40.

Example: Set PDOP mask to 20:

```
$PASHS,PDP,20 <Enter>
```

PEM: Position Elevation Mask

\$PASHS,PEM,d1,[d2]

Sets elevation mask for position computation, where d1 is the primary position elevation mask, and d2 is an optional zenith position elevation mask. Both d1 and d2 may be set to any value between 0 and 90 degrees, although d1 must be less than d2. The default for the primary position elevation mask is 10 degrees. The default for the zenith position elevation mask is 90 degrees.

Example: Set primary position elevation mask to 15 degrees

```
$PASHS,PEM,15 <Enter>
```

Example: Set primary position elevation mask to 15 degrees, and zenith position elevation mask to 80 degrees:

```
$PASHS,PEM,15,80 <Enter>
```

PHE: Photogrammetry Edge (Event Marker Edge)

\$PASHS,PHE,c

Sets the photogrammetry time tag to either the rising or falling edge of the pulse. The Event Marker receiver option (E) must be installed for this command to work.

Table 6.31. PHE Parameter Table

Setting Parameter	Description	Range
c	direction of photogrammetry edge	'R' - rising (default) 'F' - falling

Example: Set the photogrammetry edge to the falling edge.

```
$PASHS,PHE,F <Enter>
```

\$PASHQ,PHE,c

Query photogrammetry edge setting, where c is the output port and is not required to send the output message to the current communication port.

Example: Query photogrammetry edge setting to port C.

```
$PASHQ,PHE,C <Enter>
```

\$PASHR,PHE

The response message is in the form:

```
$PASHR,PHE,c*cc <Enter>
```

Table 6.32 outlines the response format.

Table 6.32. PHE Message Structure

Return Parameter	Description	Range
c	photogrammetry edge	'R' - rising 'F' - falling
*cc	checksum	N/A

PJT: Log Project Data

\$PASHS,PJT,c1s2s3s4s5s6

This command allows you to enter project data related to the station occupation. This information will appear in the S-file and in the \$PASHQ,INF query.

Table 6.33. PJT Parameter Table

Parameter	Description	Range
c1	Session	1 character alphanumeric
s2	Receiver ID	3 character alphanumeric
s3	Antenna ID	3 character alphanumeric
s4	Month and Day (mmdd)	mm = 01-12 dd = 01-31
s5	Operator Initials	3 character alphanumeric
s6	Comment	9 character alphanumeric

There are no commas between parameters.

Example: Set project data
with the following settings:

- Session = A
- Receiver ID = 123
- Antenna ID = 456

- Month and Day = July 12th (0712)
- Operator Initials = DWR
- Comment = TESTPROJ

\$PASHS,PJT,A1234560712DWRTESTPROJ

PMD: Position Mode

\$PASHS,PMD,d

Set position mode for minimum number of SVs required to compute a position fix, where d = 0, 1, 2, or 3. The default is 0.

Table 6.34. PMD Parameter Table

Parameter	Description
d = 0	minimum of 4 SVs needed (e.g., for 3-D)
d = 1	default, minimum of 3 SVs needed; with 3 SVs, altitude is held (2-D); with 4 or more, altitude is not held (3-D)
d = 2	minimum of 3 SVs needed; altitude always held (always 2-D)
d = 3	minimum of 3 SVs needed; with 3 SVs, altitude is always held; with 4 SVs, altitude is held only if HDOP is greater than HDOP mask (2-D), otherwise 3-D

Example: Set min SVs required for position computation to 4:

\$PASHS,PMD,0 <Enter>

POS: Set Antenna Position

\$PASHS,POS,m1,c2,m3,c4,f5

Sets the position of the antenna used in differential base mode.

Table 6.35. POS Parameter Table

Parameter	Description	Range
m1	latitude in degrees, decimal minutes (ddmm.mmmmmmm)	0 - 90.0
c2	North (N) or South (S)	N, S
m3	longitude in degrees, decimal minutes (dddmm.mmmmmmm)	0 - 180.0

Table 6.35. POS Parameter Table

Parameter	Description	Range
c4	East (E) or West (W)	E, W
f5	the ellipsoidal height in meters	± 0 - 99999.999

Example: Set antenna position

```
$PASHS,POS,3722.2912135,N,12159.7998217,W,15.25 <Enter><Enter>
```

POW: Battery Parameters

\$PASHS,POW,d1,d2,f3

The POW command allows you to enter parameters associated with the external battery. The query and response will use those parameters to compute the approximate amount of available time left on the battery.

Table 6.36. POW Parameter Table

Parameter	Description	Range
d1	battery capacity in mAh	500 - 10000
d2	battery capacity in percent (percent charged)	0-100
f3	battery voltage	10.0 - 28.0

Example: Set the POW parameters of a 12 volt battery with a capacity of 5000 mAh that is 100% charged.

```
$PASHS,POW,5000,100,12.0 <Enter>
```

\$PASHQ,POW,c

The POW query command requests current available battery power data, where c is the optional port to which the response will be sent. For external battery, the available battery power displayed in the response is computed from the battery parameters entered and the amount of time the receiver has been on after they were entered. For internal battery, it is read from the smart battery, no \$PASHS,POW is required in that case.

```
$PASHR,POW,d1,d2,d3,f4*cc <Enter>
```

Table 6.37. POW Message Structure

Parameter	Description	Unit
d1	battery capacity (time)	minutes
d2	capacity remaining	minutes
d3	battery capacity (power)	mAh
f4	battery voltage	volts
*cc	checksum	n/a



The data shown for the external battery is estimated based on user entered parameters. The user should re-enter the battery parameters after clearing the receiver's internal memory. The data displayed for the internal battery is the direct reading from the smart battery.

PPO: Point Positioning

\$PASHS,PPO,c

Enable/disable point positioning mode, where c is either Y (enable) or N (disable). Point positioning is an averaging algorithm that will improve the stand alone accuracy of a static point after about 4 hours.

Table 6.38. PPO Parameter Table

Parameter	Description	Range
c	Enable/disable point position mode	Y/N

Example: Enable point positioning

\$PASHS,PPO,Y

PPS: Pulse Per Second

\$PASHS,PPS,d1,f2,c3

The receiver generates PPS pulse with programmable period and offset with respect to GPS time. The PPS set command allows the user to change the period and the offset of the pulse, and to either synchronize the rising edge of the pulse with GPS time, or synchronize the falling edge of the pulse with GPS time. PPS is generated by default once every second with its rising edge synchronized to GPS time and no offset.

Table 6.39. PPS Message Structure

Parameter	Description	Range	Units
d1	period	0-60	Second
f2	offset	±999.9999	Milliseconds
c3	rising edge or falling edge	R / F	n/a

The period set to 0 will disable the PPS output. Between 0 and 1, the period can be set in increments of 0.1. Between 1 and 60, the period can be set in increments of 1.



Example: Set PPS to a period of 2 seconds, a offset of 500ms, and synchronize the rising edge of the pulse with GPS time.

```
$PASHS,PPS,2,+500,R <Enter>
```

\$PASHQ,PPS,c

Query PPS parameter where c is the output port. Note that c is not required to direct the response message to the current communication port.

Example: Query PPS parameters to port A.

```
$PASHQ,PPS,A <Enter>
```

\$PASHR,PPS

The response is in the form:

```
$PASHR,PPS,d1,f2,c3*cc <Enter>
```

where Table 6.40 outlines the structure:

Table 6.40. PPS Response Structure

Parameter	Description
d1	Period. Range from 0 to 60.0
f2	Offset, Range from -999.9999 to +999.9999
c3	Edge, R = rising edge or F = falling edge
cc	Checksum

PRT: Port Setting

\$PASHQ,PRT,c

Display the baud rate setting for the connected communication port where c is the optional output port. Note that to direct the response message to the current communication port, the c is not required.

Example: Query the baud rate of the current port.

```
$PASHQ,PRT <Enter>
```

\$PASHR,PRT

The response is a message in the format:

```
$PASHR,PRT,c1,d2*cc <Enter>
```

Table 6.41. PRT Response Structure

Parameter	Description	Range
c1	Serial port	A - D

Table 6.41. PRT Response Structure (continued)

Parameter	Description	Range
d2	Baud rate code	0 - 9 (See table below)
*cc	Checksum	n/a

Table 6.42. Baud Rate Codes

Code	Baud Rate	Code	Baud Rate
0	300	5	9600
1	600	6	19200
2	1200	7	38400
3	2400	8	56800
4	4800	9	115200

PWR: Sleep Mode

\$PASHS,PWR,off

Direct the receiver to immediately go into sleep mode. Once a receiver is in sleep mode, any character issued through any port will restore normal operation.

Example: Put receiver into sleep mode

```
$PASHS,PWR,OFF <Enter>
```



This command doesn't apply to Z-Eurocard since the power supply is external to the board.

RCI: Recording Interval

\$PASHS,RCI,f1

Set the value of the interval for data recording and raw data output, where f1 is any value between 0.1 and 999. Values between 0.1 and 1 can increment in 0.1 secs. Values between 1 and 999 can increment in 1 second. The default is 20.0.

Example: Set recording interval to 5 seconds

```
$PASHS,RCI,5 <Enter>
```



If the fast data option (F) is not installed, the setting 0.1 second is not available. All other settings (0.2 to 999) are available except 0.7 which is never available.



When running the receiver in 5Hz RTK mode (H option required), if the Fast Data option (F) is installed you will be allowed to set the RCI parameter to 0.1 second but will only receive solution output at 0.2-second intervals.

REC: Data Recording

\$PASHS,REC,c

Data recording switch that turns data recording to either Yes, No, Stop, or Restart. Yes and No are used to enable/disable data recording. The default is Yes. Stop is used prior to removing a PCMCIA card from the receiver while the receiver is recording data. This will prevent any corruption of the data files on the PCMCIA card. When the same or another PCMCIA card is inserted into the receiver, the receiver will automatically restart data recording. The Restart command is necessary to restart data recording only if the Stop command is used, but the PCMCIA card is not actually removed.

See \$PASHQ,RAW command for a list of the various states this parameter can

take internally.

Table 6.43. REC Message Structure

Setting Parameter	Description	Range
c	'Y' Record data 'N' Do not record data 'S' Stop data recording 'R' Restart data recording	'Y' / 'N' / 'S' / 'R'

Example: Disable recording data

\$PASHS,REC,N <Enter>

REC,N will disable recording but will not close the session. Whenever REC,Y is issued, recording will resume in the same session. REC,S will close the session, and a new session will be created if REC,R is used or if the card is reinserted.

RID: Receiver ID

\$PASHQ,RID,c

Request information about the receiver type, firmware and available options, where c is the optional output port.

Example: Query the current port for receiver identification

\$PASHQ,RID <Enter>

\$PASHR,RID

The return message is in the form:

\$PASHR,RID,s1,d2,s3,s4,s5*cc <Enter>

Table 6.44. RID Message Structure

Return Parameter	Description	Range
s1	Receiver type	UZ
d2	Channel option Codeless option	3 (C/A, PL1, P L2) 0
s3	nav firmware version	4 char string
s4	Receiver options	Refer to Table 1.2.
s5	boot version	4 char string
*cc	checksum	in hex

Example:

Response: \$PASHR,RID,UZ,30,UC00,-UE-MF-3J-,0A13*43 <Enter>

RNG: Data Type

\$PASHS,RNG,d

Sets data recording mode where d is the desired data type.

Table 6.45. RNG Data Modes

Setting Parameter	Description	Range
d	Data recording mode 0 - creates B-file that includes carrier phase, code phase and position data 2 - creates a C-file with smoothed positions only 4 - creates both a B-file and a C-file	0,2,4

Example: Set data recording mode to 2

\$PASHS,RNG,2 <Enter>

RST: Reset Receiver to default

\$PASHS,RST

Reset the receiver parameters to their default values. The RST command reset all parameters except the POW, MET, TLT, and MDM command parameters, including the baud rate of the modem port. For more information on default values, see the Operations Section.

Example: Reset receiver parameters

\$PASHS,RST <Enter>

CAUTION

Ensure that 110 millisecond delay occurs before a new set command is issued.

RTR: Real-Time Error

\$PASHR,RTR

This is an unsolicited response message that the receiver sends when a runtime error occurs. The response is an unsigned hex long word bitmap with the bit assignment listed in Table 6.46 indicating the position computation did not converge.

The message is in the form shown below:

```
$PASHR,RTR,h*cc <Enter>
```

Table 6.46. RTR Message Structure

Bit #	Description
13	Autonomous position did not converge.

SAV: Save User Parameters

\$PASHS,SAV,c

Enables or disables saving user parameters in memory, where c is Y (yes) or N (No). This command saves any parameters that have been modified from their default values prior to issuing the command. User parameters are saved until commands INI or RST are issued, or until SAV is set to N and a power cycle occurs.

POW, MET, TLT, MDM, and SES-related parameters are saved automatically every time the corresponding set command is issued.

Example: Save modified user parameters.

```
$PASHS,SAV,Y <Enter>
```

\$PASHQ,SAV,c

This command queries the receiver to determine if the user parameters have been saved, where c is the optional output port.

Example: Query receiver for saved user parameter status. Output the response to the current port:

```
$PASHQ,SAV <Enter>
```

\$PASHR,SVS

The response message is in the form:

```
$PASHR,SAV,c1 *cc
```

where c1 is either Y (parameters saved) or N (parameters not saved).

SEM: Secondary Elevation Mask

\$PASHS,SEM,d1,d2,d3

Sets the secondary elevation mask for position computation, where d1 is the secondary elevation mask angle, d2 is the first azimuth defining the secondary sector, and d3 is the second azimuth defining the secondary sector. The secondary elevation mask only affects position computation and has no effect on

data recording or raw data output. The default is OFF.

Example: Set secondary elevation mask to a mask angle of 50 degrees between azimuth 30 degrees and 60 degrees:

```
$PASHS,SEM,50,30,60<Enter>
```

To disable the secondary elevation mask, enter the command \$PASHS,SEM,OFF <Enter>

SES: Session Programming

\$PASHS,SES,PAR,c1,d2,d3

Set session programming parameters, where c1 sets the session mode, d2 and d3 set the reference day and daily offset (Table 6.47). The reference day must be equal to or less than the current day for session programming to operate. Issue the \$PASHS,SES,SET command to program individual sessions.

Table 6.47. SES,PAR Message Structure

Setting Parameter	Description	Range
c1	Session in use Y = Yes N = No S = Sleep Mode	Y or N or S
d2	Session reference day	1-366
d3	Session offset (mm:ss)	0-59



This command and all the other session programming commands applies only to Z-Surveyor and Z-FX receiver.

Example: Enable session programming parameters with 4-minute daily offset to keep track of the daily change of the GPS satellite configuration.

```
$PASHS,SES,PAR,Y,121,0400 <Enter>
```

\$PASHS,SES,SET,c1,c2,d3,d4,f5,d6,d7,d8

Set the individual sessions for session programming. This command will set a single session. Up to 10 sessions may be programmed. This command must be

used with \$PASHS,SES,PAR.

Table 6.48. SES,SET Message Structure

Setting Parameter	Description	Range
c1	Session name	A-Z
c2	Session flag	Y = Yes N = No
d3	Session start time (hhmmss)	hh = 0-23 mm = ss = 0-59
d4	Session end time (hhmmss)	hh = 0-23 mm = ss = 0-59
f5	Session record interval	0.1-999
d6	Session Elevation Mask	0-90
d7	Session min SV	1-9
d8	Session data type	0, 2, or 4

Example: Set a session starting at 0100 that will run for 2 hours.

```
$PASHS,SES,SET,A,Y,010000,030000,10.0,10,3,0 <Enter>
```



If sleep mode is enabled, the receiver will automatically power on 2 minutes prior to session time to ensure all available satellites are tracked by the time recording starts. This command applies only to the Z-Xtreme, Z-surveyor and Z-FX receivers.

\$PASHS,SES,DEL

Clear all session programming parameters and reset to default values.

Example: Clear all session programming parameters:

```
$PASHS,SES,DEL<Enter>
```

\$PASHQ,SES,c

Query session programming parameters, where c is optional output serial port.

Example: Query session programming parameters:

```
$PASHQ,SES <Enter>
```

Typical SES return message:

```
A N      00:00  00:00  020.0  10  3  0
B N      00:00  00:00  020.0  10  3  0
C N      00:00  00:00  020.0  10  3  0
D N      00:00  00:00  020.0  10  3  0
E N      00:00  00:00  020.0  10  3  0
.
.
.
Z N      00:00  00:00  020.0  10  3  0
INUSE:N  REF:000  OFFSET:00.00  TODAY:000
```

Table 6.49 lists the SES parameters in alphabetic order:

Table 6.49. SES Message Structure

Return Parameter	Description	Range
1st column	Session Name	A-Z
2nd column	Session enabled flag	'Y' / 'N'
3rd column	Session start time (hours, minutes, seconds)	hh:mm:ss
4th column	Session end time (hours, minutes, seconds)	hh:mm:ss
5th column	Session recording interval (seconds)	0.1-999
6th column	Session elevation mask	0-90
7th column	Session minimum SVs	1-9
8th column	Session data type	0, 2, or 4
INUSE	Session use	Y or N or S
REF	Session reference day	0-366
OFFSET	Session time offset (minutes, seconds)	mm:ss
TODAY	Date of the year	0-366

 This command applies only to the Z-Xtreme, Z-surveyor and Z-FX receivers

\$PASHQ,SSN,c

Query session programming parameters of an individual session, where c is the session letter. To query the first session, set c = A. To query the last session, set c = Z.

Example: Query session programming parameters of session D:

\$PASHS,SSN,D<Enter>

\$PASHR,SSN

The SSN response message is in the form shown below and defined in Table 6.50.

Table 6.50. SSN Message Structure

Parameter	Description	Range
c1	In Use flag. Y=Yes, N=No, A=Active	Y, N, A
d2	Reference day of all programmed sessions	0 - 365
d3	Offset per day (minutes)	0 - 60
d4	Offset per day (seconds)	0 - 60
d5	Total number of programmed sessions	1 - 26
d6	Session number requested	0 - 25
c7	Session letter requested	A - Z
d8	Session use flag Y = set, N = session not set	Y, N
d9	Session start time (hours)	0 - 23
d10	Session start time (minutes)	0 - 60
d11	Session start time (seconds)	0 - 60
d12	Session end time (hours)	0 - 23
d13	Session end time (minutes)	0 - 60
d14	Session end time (seconds)	0 - 60
f15	Epoch interval (seconds)	0.1 - 999.0
d16	Elevation mask (degrees)	0 - 89
d17	Minimum number of satellites for recording	0 - 9
d18	Ranger mode	0 - 2

SID: Serial Number

\$PASHQ,SID,c

Query receiver serial number and firmware timestamp, where c is the optional output port.

Example: Query receiver serial number

\$PASHQ,SID <ENTER>

Return message:

DATE: / /

SER#:111122223333

The date field is there for backward compatibility.

SIT: Set Site Name

\$PASHS,SIT,s

Sets site name where s is the 4 character site ID. Only characters that are DOS compatible are allowed (i.e., excludes "*", ".", "/", and "\". "?" will be converted to "_" in the file name).

Example: Set site name to ECC1

```
$PASHS,SIT,ECC1 <Enter>
```

SPD: Serial Port Baud Rate

\$PASHS,SPD,c1,d2

Set the baud rate of the receiver serial port c1, where c1 is port A, B, C, or D and d2 is a number between 0 and 9 specifying the baud rate as shown in Table 6.51. Default is 9600 baud.

Table 6.51. SPD Baud Rate Codes

Code	Baud Rate	Code	Baud Rate
0	300	5	9600
1	600	6	19200
2	1200	7	38400
3	2400	8	56800
4	4800	9	115200

To resume communication with the receiver after changing the baud rate using this command, be sure to change the baud rate of the command device.

Example:

Set port A to 19200 baud

```
$PASHS,SPD,A,6 <Enter>
```

STA: Satellite Status

\$PASHQ,STA,c

Show the status of SVs currently locked, where c is the optional output serial port.

Example: Query satellite status to the current port

```
$PASHQ,STA <Enter>
```

The return message is in a free-form format. A typical response is:

```
TIME:    03:24:24 UTC
LOCKED:  23 22 17 06 30 10 26
CA S/N   50 46 54 53 43 43 44
P1 S/N   48 00 52 51 36 00 00
P2 S/N   44 00 48 47 38 00 00
SVELEV:  18 65 44 27 31 39 75
```

Table 6.52. STA Message Structure

Return Parameter	Description	Range
TIME	Current UTC time in hours, minutes, & seconds (or GPS time if GPS is indicated instead of UTC)	hh:mm:ss
LOCKED	PRN number of all locked satellites	1-32
CA S/N	Signal-to-noise ratio of the C/A observable in dB Hz	30-60
P1 S/N	Signal to noise ratio of the L1 P-code observable in dB Hz	30-60
P2 S/N	Signal to noise ratio of the L2 P-code observable in dB Hz	30-60
SVELEV	Satellite elevation in degrees	0 - 90



After a cold start it can take the receiver up to 12.5 minutes to obtain UTC time; during this period, GPS time is displayed in the TIME field.

SVS: Satellite Selection

\$PASHS,SVS,c1c2c3.....c32

Select SVs that the receiver attempts to acquire, where:

c = Y, SV is used (default).

Set tiltmeter trigger string, where c is the output port and s is the trigger string.

Table 6.53. TLT,CMD Message Structure

Parameter	Description	Range
c	Serial port connected to the tiltmeter	A - D
s	trigger string of the tiltmeter excluding the starting '*' sign	Limited to 20 alphanumeric characters

Example: Set *9900XY to the TLT CMD field:

\$PASHS,TLT,CMD,C,9900XY <Enter>

TLT,INIT : Tiltmeter Initialization

\$PASHS, TLT,INIT,c,s

Set tiltmeter initialization string.

Table 6.54. TLT,INIT Message Structure

Parameter	Description	Range
c	Serial port connected to the tiltmeter	A - D
s	initialization string of the tiltmeter excluding the starting '*' sign	Limited to 20 alphanumeric characters

Example: Set *9900ID to the INIT STRING_ TLT field.

\$PASHS,TLT,INIT,A,9900ID <Enter>

TLT,INTVL: Tiltmeter Interval

\$PASHS, TLT,INTVL,c,d

Set the interval for the query of the tiltmeters, as specified in Table 6.55.

Table 6.55. TLT,INTVL Message Structure

Parameter	Description	Range
c	Serial port connected to the tiltmeter	A - D
d	sample interval for a tiltmeter	1-86400 sec (default = 1)

Example: Set the TLT SAMPLE field to 10

\$PASHS, TLT,INTVL,D,10 <Enter>

TMP: Receiver Internal Temperature

\$PASHQ,TMP,c

This command queries the receiver's internal temperature and the temperature setting at which the receiver will shut off, where c is the optional output serial port.

Example: Query current receiver temperature, and output response to port A:

\$PASHQ,TMP,A <Enter>

\$PASHR,TMP

The response message is in the form shown below and described in Table 6.56.

\$PASHR,TMP,f1,f2*cc <Enter>

Table 6.56. TMP Message Structure

Return Parameter	Description
f1	Receiver internal temperature in degrees Celsius
f2	Default receiver shut-off temperature in degrees Celsius
*cc	checksum

Example: \$PASHR,TMP,+046.50,082.00*1B <Enter>

TST:Output RTK Latency

\$PASHS,TST,d

Enable/Disable the output of the RTK (fast CPD) latency as decimal part of the age of correction in the GGA message. There is no query to check this setting since it is visible in the GGA message; age of correction is an integer number when disabled, as listed in Table 6.57.

This setting will revert back to default at power-on, unless saved in battery-backed memory through the \$PASHS,SAV,Y command (issued after setting the desired mode).

Table 6.57. TST Message Structure

Parameter	Description
d	220 - enable RTK latency output 221 - disable RTK latency output (default)

Example: Enable Fast CPD latency output
\$PASHS,TST,220 <Enter>

UNH: Unhealthy Satellites

\$PASHS,UNH,c

Include unhealthy satellitess for position computation, where c is Y (yes) or N (no, default)

Example: Include unhealthy satellitess in position computation
\$PASHS,UNH,Y <Enter>

USE: Use Satellites

\$PASHS,USE,d,c

Selects satellites to track or not track, where d is the PRN number of the satellite (range from 1 to 32) or ALL for all satellites and c is Y (enable) or N (disable).

Example: Do not track satellite 14
\$PASHS,USE,14,N <Enter>

VDP: VDOP Mask

\$PASHS,VDP,d

Sets the value of VDOP mask, where d is between 0 and 99. The default is 4.

Example: Set VDOP to 6:
\$PASHS,VDP,6 <Enter>

WAK: Warning Acknowledgment

\$PASHS,WAK

This command acknowledges a warning condition (status displayed by WARN will go from CURRENT to PENDING) and will stop the receiver beep that accompanies a warning (if the beep is set to ON).

WARN: Warning Messages

\$PASHQ,WARN,c

This queries the receiver for any warning messages, where c is the optional output port.

Example: Query receiver warning status:
\$PASHQ,WARN <Enter>

\$PASHR,WARN

The response is in the form:

\$PASHR,WARN,s1,s2*cc <Enter>

Table 6.58. WARN Message Structure

Parameter	Significance	Range
s1	Warning Message - NONE = no warnings	For a list of all warning message, refer to Table 6.59.
s2	Status - Pending = has been acknowledged Current = has not been acknowledged Occurred = error condition has occurred but is no longer current.	'PENDING', 'CURRENT', 'OCCURED'

Table 6.59 lists the possible warnings the receiver may issue.

Table 6.59. Receiver Warning Messages

Warning	Definition	Action
Int. Battery Error : SMBus	The SMBus controller (for internal battery communication) is not working	Remove battery and reinsert it. If problem persists, insert a different battery. If problem still persists, contact Technical Support.
Int. Battery Error : Access	Can not access the internal battery	Remove battery and reinsert it. If problem persists, insert a different battery. If problem still persists, contact Technical Support.
Battery Conditioning Required	Internal battery efficiency is down, it requires a conditioning cycle.	Perform battery reconditioning (depends on the battery, but typically means full charge, full discharge and full charge again)
Low Int. Battery : < 10 min	Internal battery remaining life is < 10 min, the battery needs to be changed	Replace battery with a charged one.

Table 6.59. Receiver Warning Messages (continued)

Warning	Definition	Action
Low Ext. Battery : < 30 min	External battery remaining life is < 30 min, the battery needs to be changed. This is only available if the user has entered the parameters of the external battery via the \$PASHS,POW command.	Replace battery with a charged one.
†Memory Test Error : RAM	RAM error	Perform a receiver initialization. If problem persists, contact Technical Support.
†Memory Test Error : BBRAM	Battery backed Ram	Perform a receiver initialization. If problem persists, contact Technical Support.
†Memory Test Error : ROM	ROM, i.e. Flash	Perform a receiver initialization. If problem persists, contact Technical Support.
†Memory Test Error : BOOT	Boot section of the flash	Perform a receiver initialization. If problem persists, contact Technical Support.
No Data Card Detected	There is no card in the PCMCIA drive or it cannot be detected; no recording	Insert or reinsert data card in slot.
Data Card Full	No space left on the PC card, therefore data recording is stopped	Replace current data card with a card containing available memory, or delete some older sessions.
Data Card Full <5 min	Not enough space on the PC card to record more than five minutes of data under current conditions (satellite number, recording period, output information).	Replace data card with one containing available memory, or delete older sessions.
†Data Card Error : Access	Can't read or write to the PC card	Power cycle the receiver. If problem persists, issue command \$PASHS,CLM (card will be reformatted and all data erased, so download data prior to issuing the CLM command). If problem persists, replace the PC card.

Table 6.59. Receiver Warning Messages (continued)

Warning	Definition	Action
†Data Card Error : Update	Can't update the FAT (file allocation table)	Power cycle the receiver. If problem persists, issue command \$PASHS,CLM (card will be reformatted and all data erased, so download data prior to issuing the CLM command). If problem persists, replace the PC card.
†Data Card Error : Create	Can't create the files for new session so we can't record data	Power cycle the receiver. If problem persists, issue command \$PASHS,CLM (card will be reformatted and all data erased, so download data prior to issuing the CLM command). If problem persists, replace the PC card.
†Data Card Error : Rename	Can't rename the files of session	Power cycle the receiver. If problem persists, issue command \$PASHS,CLM (card will be reformatted and all data erased, so download data prior to issuing the CLM command). If problem persists, replace the PC card.
†Data Card Error: Corrupted FAT	File Allocation Table on PCMCIA card has been corrupted and could not be recovered by the receiver.	Issue command \$PASHS,CLM to reformat the card. If critical data is on the PC card, call Customer Support before issuing the CLM command to recover data.
Not Receiving Base Data	Not receiving RTK carrier phase measurements from the base receiver	Check serial/radio link with the base. Verify that base is computing a position. Ensure a valid position was entered into the base
Not Receiving RTCM Base Data	Not receiving RTCM code phase corrections from the base receiver	Check serial/radio link with the base. Verify that base is computing a position. Ensure a valid position was entered into the base.
Bad Base Coordinates	The position entered in the base receiver for CPD operation is not correct (too far from computed position)	<ul style="list-style-type: none"> • Base position was entered wrong on the rover side. Reenter it. • The mode in the base receiver was set to not send BPS, set base to send BPS (\$PASHS, CPD,UBP,1). • If rover is in "entered base station" (\$PASH,CPD,UBP,O). Enter the base position in the rover via \$PASHS,BPS,POS. • If rover is in "receiver base position" mode (default or \$PASHS,CPD,UBP,1), check link with base. • Make sure the base sends base coordinates (\$PASHS,BPS,PER,O)

Table 6.59. Receiver Warning Messages (continued)

Warning	Definition	Action
Bad RTCM Base Position	The position entered in the base receiver for RTCM code operation is not correct (too far from computed position)	Enter correct base position.
†‡Not Enough Satellites	Tracking fewer than the minimum number of satellites required for kinematic survey	The kinematic survey must be reinitialized on last point.
Low Backup Battery	The battery powering the non-volatile memory and the real-time clock is low and needs to be changed	Contact Customer Support. Back-up battery must be replaced.
Antenna Overload	Antenna installation problems, i.e. the set-up is drawing more than 150 milliamps (short on antenna cable or LNA drawing too much current)	Check antenna connection for bad cable or bad LNA.
No Antenna Detected	Does not sense any antenna: WARNING, this will be the case if a DC block is installed somewhere between the receiver and the antenna	Check antenna connection for bad cable or bad LNA. There may be another receiver connected to the same antenna with no DC block, or this receiver is connected to the antenna via a DC block.
MODEM Communication Error	Cannot communicate with the modem	Check serial connection to the modem. Check power on modem. Check baud rate of modem-it should match baud rate of receiver. Reinitialize modem.
MODEM Initialization Error	Cannot initialize the modem	Check serial connection to the modem. Check power on modem. Check baud rate of modem-it should match baud rate of receiver. Reinitialize modem.

Table 6.59. Receiver Warning Messages (continued)

Warning	Definition	Action
High Receiver Temperature	Inside receiver temperature > 80 deg Celsius: the receiver will turn off automatically at 82 deg Celsius (this message might be seen when the external ambient temperature is >55 degrees Celsius)	Cover the receiver from the sun. Increase air flow around receiver. NOTE: If the receiver's temperature is still going up, it will automatically switch to the sleep mode, in reduced power consumption mode as a safety measure. To recover, cycle the Power, after having eliminated the source of overheating.
Download in Progress	Receiver is currently downloading data from the PCMCIA card to a PC. No front panel operations can be conducted at this time.	Wait for Download to complete operation before performing the command. If Download is not running, run Download again, perform proper shutdown routine. Do not disconnect serial link to PC before exiting Download.
† Indicates warning is permanent (the warning will NOT go away if the condition disappears, but only if it is acknowledged). ‡ Indicates error will only display if antenna is present.		

WKN: GPS Week Number

\$PASHQ,WKN,c

This command queries the current GPS week number, where c is the optional output serial port.

Example: Query receiver for GPS week number

\$PASHQ,WKN <Enter>

\$PASHR,WKN

Returns current GPS week number, where the message is in the form:

\$PASHR,WKN,d1*cc <Enter>

Table 6.60. WKN Message Structure

Parameter	Description
d1	current GPS week number

Raw Data Commands

The raw data commands cover all query and set commands related to measurement, ephemeris, and almanac data.

Set Commands

There is only one set command that controls the continuous output of all raw data messages; the \$PASHS,OUT command. The \$PASHS,OUT command allows you to enable or disable the output of one or more raw data messages simultaneously as well as change the format (ASCII or Binary) of the messages types where the format is an option. The general format of the \$PASHS,OUT command is:

```
$PASHS,OUT,c,str(,str...),s
```

where c is the output serial port (A-D), str is one or more 3 character strings that denote the different raw data output types, and s is the optional format of the message and is either ASC (ASCII) or BIN (binary). For example, the command:

```
$PASHS,OUT,A,MBN,PBN,BIN <Enter>
```

will output MBEN and PBN messages in binary format to serial port A. If the format field is not included, then the message will be sent in ASCII format which is the default. The ephemeris and almanac messages are available in binary format only. If a user attempts to output a raw data message type in ASCII format when only binary is available, the receiver will send the header only with no additional information or data. Also, be aware that a \$PASHS,OUT command will override anything set in a previous \$PASHS,OUT command.

If the \$PASHS,OUT command is sent correctly, the receiver will respond with the \$PASHR,ACK acknowledgment. The messages will be output to the indicated serial port at the recording interval defined by the \$PASHS,RCI command. The default output frequency is every 20 seconds. The \$PASHS,RCI command controls both the rate of data recorded to the PCMCIA card, as well as the output of raw data from the serial port.

It is possible to set one rate of data recording to the PCMCIA card and a different rate of raw data output to the serial port. This is done using the \$PASHS,DRI and the \$PASHS,DOI commands. \$PASHS,DRI sets the data recording rate to the PCMCIA card. \$PASHS,DOI sets the rate of raw data output to the serial port. The default of both these commands is 20.0 seconds. Be aware that setting the \$PASHS,RCI command will override any parameter previously set in the DRI or DOI command.

Raw data messages are disabled by sending the \$PASHS,OUT command with no data strings. For example the command:

```
$PASHS,OUT,A <Enter>
```

will disable the output of all raw data output from port A. See the \$PASHS,OUT command in this section for more details. To see what raw data messages have been enabled, use the \$PASHQ,RAW query.

In general, the parameters that affect raw data output are the same as those that control data recording including: recording interval, elevation mask, and minimum number of SVs. See the Raw Data Command table for more details about the commands that control these parameters.

Query Commands

The query commands will output a single raw data message type once. The general format of the query commands is:

```
$PASHQ,s,c
```

where *s* is the 3 character string that denotes the raw data message type, and *c* is the serial port to which the message will be output. The serial port field is optional. If the query is sent with the port field left empty, then the response will be sent to the current port. If the port field contains a valid port (A-D), then the response will be output to that port. For example, the query:

```
$PASHQ,PBN <Enter>
```

will output a single PBEN message to the current port. The command:

```
$PASHQ,MBN,C <Enter>
```

will output a single set of MBEN message to port C. It is not possible to change the format (ASCII or Binary) of the response with a query command. If the format of the port is ASCII, the response will be in ASCII, unless the ASCII format is not available for that message type. In this case, the receiver will send only the header of the raw data message.

There are no ACK command acknowledgments for queries. If the query has been enter properly, and the data is available (for example, MBEN is not available unless the receiver is tracking enough satellites above the elevation mask), then the acknowledgment will be the data response message.

Table 6.61 lists the raw data types, the associated 3-character string used in the commands, and the format available for each data type.

Table 6.61. Raw Data Types and Formats

Raw Data Type	3-Character String	Description	Format Available
MBEN	MBN	Measurement data	ASCII/binary
PBEN	PBN	Position data	ASCII/binary
SNAV	SVN	Ephemeris data	Binary only

Table 6.61. Raw Data Types and Formats (continued)

Raw Data Type	3-Character String	Description	Format Available
SALM	SAL	Almanac data	Binary only
EPB	EPB	Raw ephemeris	Binary only
DBEN	DBN	CPD carrier phase	Binary only
CBEN	CBN	CPD position data	ASCII/binary
CMR	CMR	CPD carrier phase	Binary only

Table 6.62 lists all the raw data commands. A complete description of each command can be found on the pages following the table.

Table 6.62. Raw Data Commands

Command	Description	Page
ALMANAC DATA		
\$PASHQ,SAL	Almanac query	177
CPD PARAMETERS		
\$PASHQ,CBN	CBEN query	148
\$PASHQ,DBN	DBEN query	159
EPHEMERIS DATA		
\$PASHQ,SNV	SNAV query	178
\$PASHQ,EPB	Raw ephemeris data query	164
MEASUREMENT DATA		
\$PASHQ,MBN	MBEN query	167
POSITION DATA		
\$PASHQ,PBN	PBEN query	172
RAW DATA OUTPUT		
\$PASHS,OUT	Enable/disable raw data output	172
\$PASHQ,RWO	Query raw data output settings	177
\$PASHQ,RAW	Query raw data parameters	175
\$PASHS,SIT	Set site name	134
\$PASHS,ELM	Set elevation mask	96
\$PASHS,RCI	Set recording interval	125
\$PASHS,MSV	Set minimum # of SVs	113

CBN: CBEN Message

\$PASHQ,CBN,c

Request CBEN data for one epoch, where c is the optional output port.

Example: Query CBN message to the current port.

```
$PASHQ,CBN <Enter>
```

\$PASHR,CBN

The CBN response message is either ASCII format or binary format depending

upon the setting of the output port.

The format of the ASCII response message is in the form:

```
$PASHR,CBN,m1,s2,d3,f4,m5,c6,m7,c8,f9,f10,f11,f12,f13,f14,f15,s16,
f17,f18,f19,f20,f21,f22*cc <Enter>
```

Table 6.63 outlines the response structure.

Table 6.63. CBN Message Structure (ASCII Format)

Parameter	Description	Range
m1	Receiver time UTC (hhmmss.ss)	0 - 235959.99
s2	Four character site identification	
d3	Number of satellites used in position computation.	0 - 12
f4	PDOP	0 - 999.9
m5	Latitude in degrees and decimal minutes ddmm.mmmmmmm	0 - 90.0
c6	Latitude direction	'N'/'S'
m7	Longitude in degrees and decimal minutes ddmm.mmmmmmm	0 - 180- 0 - 59.9999999
c8	Longitude direction	'E' / 'W'
f9	Ellipsoid Height (meters)	-1000.000 to 18000.000
f10	Standard Deviation of latitude component (meters)	0 - 99.999 m
f11	Standard Deviation of longitude component (meters)	0 - 99.999 m
f12	Standard Deviation of ellipsoid height (meters)	0 - 99.999 m
f13	Cross correlation of XY	± 30.000 m
f14	Cross correlation of XZ	± 30.000 m
f15	Cross correlation of YZ	± 30.000 m
s16	Solution type flag containing 6 Parameters.	(see Table 6.64)
f17	Velocity of East Direction	± 500.000 m/s
f18	Velocity of North Direction	± 500.000 m/s
f19	Velocity of Upper Direction	± 500.000 m/s
f20	Standard Deviation of East Velocity	0 - 99.999 m/s
f21	Standard Deviation of North Velocity	0 - 99.999 m/s
f22	Standard Deviation of Upper Velocity	0 - 99.999 m/s
*cc	Checksum	

Table 6.64 describes the solution type flag:

Table 6.64. Solution Type Flag Table (ASCII Format)

Symbol	Value	Description
A (least significant bit)	0	No solution is available
	1	2D solution
	2	3D solution
	3	Reserved
B	0	Autonomous solution
	1	RTCM solution
	2	CPD solution
	3	Reserved
C (meaningful if B=2)	0	Float solution
	1	Fixed solution
D (meaningful if B=2)	0	Updated solution with measurement update
	1	Projected solution with time update
E (meaningful if B=2)	0	Normal CPD solution
	1	RVP CPD solution
F (meaningful if B=2)	0	Usual CPD solution
	1	Fast CPD solution

The format of the binary message is in the form:

\$PASHR,CBN, <binary data><Checksum> <Enter>

where the message structure is as defined in Table 6.65.

For the sign bit: 1 means '-'; 0 means '+'.

Table 6.65. CBN Message Structure (Binary Format)

Data Type	Symbol	Range	Resolution	Compress Num. Bits	Description
double	rcvtime	0 - 604800000	1 msec	30	Receiver time in GPS milliseconds of week
char[4]	Site_ID			32	Receiver site ID
char	Num_Svs	0 - 12		4	Number of satellites used in CPD position computation

Table 6.65. CBN Message Structure (Binary Format) (continued)

Data Type	Symbol	Range	Resolution	Compress Num. Bits	Description
unsigned short	PDOP	0 - 100	0.1	10	PDOP
double	Lat_N	sign ± deg 0-90° frac. 0 - 1	e-9 deg (e-4 m)	1 7 30	Rover position latitude north
double	Lon_E	deg 0-360° frac. 0-1	e-9 deg (e-4 m)	9 30	Rover position longitude east
double	EH	sign 1 data: -1km - 18km	0.0001 m	1 29	Rover position ellipsoid height in meters
float	Position RMS	0 - 100 m	0.001 m	17	Standard deviation of position error
float	Sigma_N / RMS/	0 - 1.0	1%	8	Standard deviation of latitude componeny/ position RMS
float	Sigma_E / RMS	0 - 1.0	1%	8	Standard deviation of longitude component/ position RMS
float	Sigma_U / RMS	0 - 1.0	1%	8	Standard deviation of ellipsoid height component/position RMS
float	Corr_EN / RMS ²	-0.5 - 0.5	1%	8	Cross correlation of lat and lon/RMS ²
float	Corr_EU / RMS ²	-0.5 - 0.5	1%	8	Cross correlation of lon and height/RMS ²
float	Corr_NU / RMS ²	-0.5 - 0.5	1%	8	Cross correlation of lat and height/RMS ²
char	FLAG	0 - 256		8	Solution type (bitwise flag)
Total bytes for the first part = 32					
float	Vel_E	sign ± data 500 m/s	0.001 m/s	1 20	Velocity of east direction
float	Vel_N	sign ± data 500 m/s	0.001 m/s	1 20	Velocity of north direction
float	Vel_U	sign ± data 500 m/s	0.001 m/s	1 19	Velocity of upper direction

Table 6.65. CBN Message Structure (Binary Format) (continued)

Data Type	Symbol	Range	Resolution	Compress Num. Bits	Description
float	Sigma_VE	0 -16.0 m/s	0.001 m/s	14	Standard deviation of east velocity
float	Sigma_VN	0 - 16.0 m/s	0.001 m/s	14	Standard deviation of north velocity
float	Sigma_VU	0 - 16.0 m/s	0.001 m/s	14	Standard deviation of upper velocity
				8	To make modular of 16
Total bytes for the second part= 14					
short	<checksum >	n/a	n/a	16	Checksum (sum of all "short" in the data)

The solution type flag has the structure defined in Table 6.66.

Table 6.66. Solution Type Flag Structure (Binary Format)

Symbol and Bits	Values	Meaning
A : bits 7 and 8		(most significant bits)
00xxxxxx	0	No solution is available
01xxxxxx	1	2D solution
10xxxxxx	2	3D solution
11xxxxxx	3	Reserved
B : bits 5 and 6		
xx00xxxx	0	Autonomous solution
xx01xxxx	1	RTCM solution
xx10xxxx	2	CPD solution
xx11xxxx	3	Reserved
C : bit 4		
xxxx0xxx	0	Float solution
xxxx1xxx	1	Fixed solution
D : bit 3		
xxxx0xx	0	Updated solution with measurement update
xxxx1xx	1	Projected solution with time update
E : bit 2		
xxxxx0x	0	Normal CPD solution
xxxxx1x	1	RVP CPD solution
F : bit 1		(least significant bit)
xxxxxxx0	0	Usual CPD solution
xxxxxxx1	1	Fast CPD solution

CMR: CMR Message

\$PASHQ,CMR,c

Query the CMR message for one epoch, where c is the optional output port.

Example: \$PASHQ,CMR <Enter>

\$PASHR,CMR

CMR is a compact measurement record which contains one epoch of GPS

pseudo-range and carrier phase measurements. It is used as an alternative message to DBEN for CPD operations.



This message only exists in binary format. If ASCII format is requested (default), only the header will be sent (\$PASHR,CMR).

An overview of the Compact Measurement Record Format is illustrated in Table 6.67. Each CMR message is surrounded by a (six byte) packet frame. Within each message frame is a header and a data section. Message types are defined for:

- Observables - L1 and L2 carrier phase and pseudorange measurements
- Reference Station Location - WGS84 Cartesian coordinates and antenna offsets
- Reference Station Description - ASCII message for station name and description

The observables message is sent once per second. The reference station location and the reference station description messages are sent every ten seconds, but are interleaved. All of the message types are described in detail below.

Table 6.67. Compact Measurement Record Structure

Transmission Structure	Size of Transmission
Packet header	4 bytes
Observables header {Type 0} (includes number of satellites [n])	6 bytes
Satellite 1 L1 observables (extended L2 data follows)	8 bytes
Satellite 1 L2 observables	7 bytes
Satellite 2 L1 observables	7 bytes
Satellite n L2 observables	7 bytes
.....
Satellite n L1 observables	8 bytes
Satellite n L2 observables	7 bytes
Packet tail	2 bytes
.....	
(observables packets)	Type 0: 9 sats = 147 bytes

Table 6.67. Compact Measurement Record Structure (continued)

Transmission Structure	Size of Transmission
Packet header	4 bytes
Reference station coordinates header {Type 1}	6 bytes
Reference station location fields	7 bytes
Packet tail	2 bytes (Type 1: 19 bytes)
.....	
(observables packets)	
.....	
Packet header	4 bytes
Reference station description header {Type 2}	6 bytes
Reference station description fields	75 bytes
Packet tail	2 bytes (Type 2: 87 bytes)

Compact Measurement Record Packet

Each CMR message is sent within a six-byte frame. Details of the packet structure are given in Table 6.68.

Table 6.68. Compact Measurement Record Packet Definition

Parameter	Number of Bytes	Description
STX	1	Start of transmission (02h)
Status	1	Status byte (00h)
Type	1	CMR message types: 0 - observables; 1 - location; 2 - description
Length	1	Number of bytes in the data block
Data Block	as per definition	Message data as defined below.
Checksum	1	Data checksum calculated using (Status + Type + Length + Data Block) mod 256
ETX	1	End of transmission

Although a checksum field is used to provide some protection against packet errors, it is the responsibility of the datalink to provide additional and sufficient error detection mechanisms to ensure that the message content received at the rover station is valid.

Observables (Message Type 0)

The Compact Measurement Record format is divided into a header portion and a data portion. The header is sent at each measurement epoch and contains timing and satellite tracking information that is relevant to the observable block. The observable block is repeated for each satellite tracked at the reference station. The header is shown in Table 6.69. The observables are shown in Table 6.70 and x.xxxxx.

Table 6.69. CMR Type 0 Message Header

Parameter	Bits	Units	Range	Description
Version Number	3	n/a	0 - 7	Defines the format version.

Table 6.69. CMR Type 0 Message Header (continued)

Parameter	Bits	Units	Range	Description
Station ID	5	n/a	0 - 31	Reference station ID.
Message Type	3	n/a	0 - 7	Describes the information that follows in subsequent data blocks. The observable message type is 0 (zero).
Number of SVs	5	n/a	0 - 31	Number of satellites contained in the observable blocks that follow.
Epoch Time	18	ms	0 - 240,000	Receiver epoch time for GPS measurements modulo 240 seconds. Epoch time is scaled into milliseconds and transmitted as an unsigned 18-bit integer.
Clock Bias Validity	2	n/a	0 - 3	Indicates that the reference receiver clock offset is valid or invalid. 0 - invalid 3 - valid
Clock Offset	12	500 ns	+/- 0.5 ms	The clock offset is given in the range -0.5 to +0.5 milliseconds. Receivers that drive their clock onto GPS time should set the clock offset parameter to zero.
Total	48			

Table 6.70. CMR Type 0 Message Observables Block

Parameter	Bits	Units	Range	Description
SV PRN	5	n/a	0 - 31	Satellite PRN identifier
P-code/CA-code flag	1	n/a	0,1	Indicates the type of code data being tracked on the L1 or L2 band. 0 = CA-code 1 = P-code
L1 phase data valid	1	n/a	0,1	Indicates the validity of the phase data. Only use phase when the validity flag is set. 0 = Invalid 1 = Valid
Extended L2 data follows	1	n/a	0,1	L2 data follows the L1 data if this flag is set. 0 = L1 only 1= L1 & L2
CA-code pseudo-range	24	1/8 L1 cycles	0 - 2^{21} L1 cycles	The L1 pseudorange is transmitted modulo 1 light millisecond (299792.458m), in units of 1/8 L1 cycles.
Carrier - Code	20	1/256 L1 cycles	$\pm 2^{19}$ (1/256 L1 cycles)	The carrier phase data is referenced against the code measurement field. The carrier phase is quantised in 1/256 L1 cycles and broadcast in the range $\pm 2^{19}$.
SNR	4	least significant bit = 2 SNR counts	0 - 15	The Signal-to Noise Ratio value is given in the range 0-15 where the least significant bit is equal to 2 SNR counts.
Cycle slip count	8	n/a	0 - 255	Incremented every time there is a cycle slip on this satellite. The rover should assume that a cycle slip has occurred if the cycle slip count increments between measurement epochs.
Total	64			

L2 Data

L2 data is appended directly to L1 observable data for each satellite (Table 6.71).

Table 6.71. CMR Type 0 Message Observables Block (L2)

Parameter	Bits	Units	Range	Description
L2 code available (A)	1	n/a	0,1	Receivers capable of tracking L2 code during encryption should set this flag to indicate that L2 code data is available. 0 = no code available 1 = code available
P-code / X-correlation (B)	1	n/a	0,1	Indicates the type of code data collected on L2. This bit is ignored if no code information is present. 0 = P-code 1 = cross correlation
Code Valid (C)	1	n/a	0,1	Indicates the validity of the L2 code information. 0 = False 1 = True
Phase Valid (D)	1	n/a	0,1	Indicates validity of the L2 phase information. 0 = false 1 = true
Phase Full (E)	1	n/a	0,1	Full-cycle L2 receivers should set this flag. 0 = half wave 1 = full wave
Reserved	3	Reserved	Reserved	Reserved
L2 range - L1 range	16	0.01 m	$\pm 2^{15}$ cm	The L2 range measurement is referenced against the L1 range measurement and broadcast in terms of integer centimeters.
L2 carrier - L1 code	20	1/256 L2 cycles	$\pm 2^{19}$ (1/256 L2 cycles)	L2 carrier phase measurement is referenced against L1 code measurement in a fashion similar to L1 carrier phase. Units for L2 carrier minus L1 code in terms of 1/256 L2 full cycles. For half-cycle data, units in terms of 1/256 L2 half cycles.
L2 SNR	4	LSB = 2 SNR counts	0 - 15	L2 signal-to-noise ratio, similar to L1 SNR.
L2 cycle slip count	8	n/a	0 - 255	L2 cycle slip count is accumulated sum of number of cycle slips at transmitting receiver.

Total 56

DBN: DBEN Message

\$PASHQ,DBN,x

Query DBEN message for one epoch where x is the optional output port.

Example: \$PASHQ,DBN <Enter>

\$PASHR,RPC

DBEN is a packed message which contains one epoch of GPS pseudo-range and carrier phase measurements. It is an essential message which is used for CPD operation.

 This message only exists in binary format. If ASCII format is requested (default) only the header will be sent (\$PASHR,RPC)

The structure is

\$PASHR,RPC,<data length><packed data><ChkSum>

where the parameters are as defined in Table 6.72 and Table 6.73.

Table 6.72. RPC Message Structure

Parameter	Type	Number of bytes	Description
Data length	unsigned short	2	Number of bytes in <packed data> part
Packed data	unsigned char[]	Data length	See Table 6.73 below.
ChkSum	unsigned short	2	Cumulative unsigned short summation of the <packed data>, after <data length> before <ChkSum>

<packed data> parameter:

Table 6.73. RPC Packed Parameter Descriptions

Data Type	Symbol	Range	Resolution	Compress Num. Bits	Description
double	rcvtime	0 - 604800000	1 msec	30	Receiver time in GPS milliseconds of week
char[4]	site ID			32	Receiver's four-character site ID
long	PRN			32	SVPRN for the satellites which have data in this message. It is a bitwise indication. Starting from least significant bit, bit 1 corresponds to SVPRN #1, bit 2 corresponds to SVPRN #2, and so on. Bit value of 1 means that SVPRN has data in this message, 0 otherwise.

For each satellite whose corresponding bit in PRN is '1', the following data will be repeated, i.e., sent once for PL1 data and a second time for PL2 data.

Table 6.73. RPC Packed Parameter Descriptions (continued)

Data Type	Symbol	Range	Resolution	Compress Num. Bits	Description
double	PL1 or PL2		1.0e-10 seconds	31	Pseudorange in units of 1.0e-10 seconds (or 0.1 nanoseconds). Multiply this value by 1.0e-10 to get pseudo-range in seconds. A zero value indicates bad pseudo-range
char	WN			1	Warning bit 1 - bad carrier phase and has possible cycle-slips 0 - good carrier phase
	Sign		1	1	Carrier phase sign bit 1 - negative carrier phase value 0 - positive carrier phase value
long	PH_I		1	28	Integer part of the carrier phase measurement in cycles
double	PH_F		15.0e-4	11	Fractional part of the carrier phase measurement in units of 5e-4 cycles. Multiply this number by 5e-4 to get fractional carrier phase in cycles. Whole carrier phase measurement = PH_I + PH_F*5.0e-4

Zeros will be padded so that all of <packed data> part is a module of 16 bits. Total number of bits in <packed data>: $\text{ceil}((94 + 72 \cdot 2 \cdot \text{Nsvs})/16) \cdot 16$ and <data length> = $\text{ceil}((94 + 72 \cdot 2 \cdot \text{Nsvs})/16) \cdot 2$ in which, $\text{ceil}(a)$ means truncates to +Inf, e.g., $\text{ceil}(3.1) = 4$, $\text{ceil}(3.5) = 4$, $\text{ceil}(3.95) = 4$. Nsvs is number of SVs.

Table 6.74 defines the DBEN message size.

Table 6.74. DBEN Message Sizes

Num of SVs	Bits	Bytes
4	808	101
5	952	119
6	1096	137
7	1240	155
8	1384	173
9	1528	191
10	1672	209
11	1816	227
12	1960	245

\$PASHR,BPS

The \$PASHR,BPS is the base station position message that is transmitted along with the DBEN message. This message has a fixed length of 96 bytes (not including the <CR><LF> and contains the base stations coordinates and antenna parameters. By default, this message is transmitted every 30 seconds.

The response message is in the form shown below and defined in Table 6.75.

`$PASHR,BPS,m1,c2,m3,c4,f5,f6,f7,f8,m3,f9,s10*cc<CR><LF>`

Table 6.75. BPS Message Structure

Field	Description	Range
m1	Latitude (degrees/decimal minutes)	0-89.9999999
c2	Latitude direction	'N'/'S'
m2	Latitude (degrees/decimal minutes)	0-179.9999999
c5	Longitude direction	'E'/'W'
f5	Altitude (meters)	+/-99999.9999

Table 6.75. BPS Message Structure

Field	Description	Range
f6	Antenna slant height (meters)	0 - 6.400
f7	Antenna radius in meters	0 - 6.400
f8	Antenna vertical offset in meters	-99.9999 - 99.9999
m3	Antenna horizontal offset: azimuth degree/decimal minutes	0-359.99
f9	Antenna horizontal offset: (meters)	0 - 99.9999
s10	Status byte in HEX	LL
*cc	checksum	

The s10 parameter is a hex coded one byte of status flag where the meaning is as shown in Table 6.76.

Table 6.76. BPS Status Byte Definition

Bit	Description
1 (LSB)	Base station coordinate is not entered
2	Base station antenna offset is not entered (This is questionable. In some cases, the user will choose to enter the antenna phase center coordinates, then the antenna offsets are all zeros)
3	The base station is not computing position with raw pseudo ranges
4	The entered coordinates are more than 500 meters different in each direction from the computed position, based on the raw pseudo ranges.
5	The base station is not tracking satellites properly (need more careful definition of not tracking satellite properly)
6,7,8	Not used

EPB: Raw Ephemeris

\$PASHQ,EPB,d

Query for raw ephemeris data output, where d is the PRN number. If no PRN number is specified, data for all available SVs will be output.

Example: Query for raw ephemeris for all available satellites.

```
$PASHQ,EPB <Enter>
```

Query ephemeris data for PRN 25.

```
$PASHQ,EPB,25 <ENTER>
```

\$PASHR,EPB

The response is the broadcast ephemeris data. See the ICD-GPS-200 for definition of the Parameters. Each subframe word is right-justified in a 32-bit long integer.

The response is in the form:

```
$PASHR,EPB,d,<ephemeris structure> <Enter>
```

This message only exists in a binary format, if ASCII format is requested (default) only the header will be sent (\$PASHR,EPB).

Table 6.77 defines the response format.

Table 6.77. EPB Response Format

Type	Size	Contents
d	2	PRN number
struct		
long	4	Subframe 1, word 1
long	4	Subframe 1, word 2
long	4	Subframe 1, word 3
long	4	Subframe 1, word 4
long	4	Subframe 1, word 5
long	4	Subframe 1, word 6
long	4	Subframe 1, word 7
long	4	Subframe 1, word 8
long	4	Subframe 1, word 9
long	4	Subframe 1, word 10
long	4	Subframe 2, word 1
long	4	Subframe 2, word 2
long	4	Subframe 2, word 3
long	4	Subframe 2, word 4
long	4	Subframe 2, word 5
long	4	Subframe 2, word 6
long	4	Subframe 2, word 7
long	4	Subframe 2, word 8
long	4	Subframe 2, word 9
long	4	Subframe 2, word 10
long	4	Subframe 3, word 1
long	4	Subframe 3, word 2
long	4	Subframe 3, word 3
long	4	Subframe 3, word 4
long	4	Subframe 3, word 5
long	4	Subframe 3, word 6
long	4	Subframe 3, word 7

Table 6.77. EPB Response Format (continued)

Type	Size	Contents
long	4	Subframe 3, word 8
long	4	Subframe 3, word 9
long	4	Subframe 3, word 10
short	2	Word checksum begin with header 'P'.
total =	122	struct size

MBN: MBN Message

\$PASHQ,MBN,c

Requests one epoch of MBN data, where c is the optional output port.

Example: Query MBN message to the current port.

```
$PASHQ,MBN <Enter>
```

\$PASHR,MPC

The response can be in either ASCII or binary format. There will be a return message for each tracked satellite above the elevation mask.

The MBN response message in binary format is in the form:

```
$PASHR,MPC,<structure> <Enter>
```

Where Table 6.78 outlines the measurement structure. The checksum is computed after the MPC header, and includes the last comma.

Table 6.78. MPC Measurement Structure (Binary Format)

Type	Size	Contents
unsigned short	2	sequence tag (unit: 50 ms) modulo 30 minutes
unsigned char	1	number of remaining struct to be sent for current epoch.
unsigned char	1	satellite PRN number.
unsigned char	1	satellite elevation angle (degree).
unsigned char	1	satellite azimuth angle (two degree increments).
unsigned char	1	channel ID (1 - 12).
		C/A code data block 29 bytes
unsigned char	1	Warning flag
unsigned char	1	Indicates quality of the position measurement. (good/bad)
char	1	(set to 5 for backward compatibility)
unsigned char	1	Signal to noise of satellite observation (db.Hz)
unsigned char	1	Spare
double	8	Full carrier phase measurements in cycles.
double	8	Raw range to SV (in seconds), i.e., receive time - raw range = transmit time
long	4	Doppler (10^{-4} Hz).

Table 6.78. MPC Measurement Structure (Binary Format) (continued)

Type	Size	Contents
long	4	bits: 0 - 23 Smooth correction (bit 0-22 = magnitude of correction in cms, bit 23 = sign) bits:24-31 Smooth count, unsigned. as follows: 0 = unsmoothed, 1=least smoothed, 200 = most smoothed
	(29)	P code on L1 block , same format as C/A code data block
	(29)	P code on L2 block , same format as the C/A code data block.
unsigned char	1	Checksum, a bitwise exclusive OR (XOR)
total bytes	95	



For details on warning flag and good/bad flag, see *MBN data struct in ASCII*.

The MBN response message in ASCII is in the form:

```
$PASHR,MPC,d1,d2,d3,d4,d5,d6,d7,d8,d9,d10,d11,f12,f13,f14,f15,
d16,d17,d18,d19,d20,d21,f22,f23,f24,f25,d26,d27,d28,d29,d30,d31,
f32,f33,f34,f35,d36,ccc <Enter>
```

Table 6.79 defines the parameters.

Table 6.79. MPC Message Structure (ASCII Format)

Parameter	Significance	Units	Range
d1	Sequence tag. This is the time tag used to associate all structures with one epoch. It is in units of 50 ms and modulo 30 minutes.	50 ms	0-36000
d2	Number of remaining structures		0-11
d3	SV PRN number		1-32
d4	Satellite elevation	degrees	0-90
d5	Satellite azimuth	degrees	0-360
d6	Channel index		1-12
C/A Code Data Block			
d7	Warning flag (see Table 6.80)		0-255
d8	Good/bad flag (see Table 6.81)		22-24
d9	5 for backwards compatibility		5
d10	signal to noise indicator	dB Hz	30-60
d11	spare		0
f12	Full carrier phase	cycles	±999999999.9
f13	Code transmit time	ms	0-999999999.9
f14	Doppler measurement	10 (-4) Hz	±99999.99999
f15	Range smoothing correction. Raw range minus smoothed range.	meters	0-99.99
d16	Range smoothing quality		0-200
PL1 Code Data Block			
d17	Warning flag (see Table 6.80)		0-255
d18	Good/bad flag (see Table 6.81)		22-24
d19	5 for backward compatibility		5
d20	Signal to noise indicator	dB Hz	30-60

Table 6.79. MPC Message Structure (ASCII Format) (continued)

Parameter	Significance	Units	Range
d21	spare		
f22	Full carrier phase	cycles	0-999999999.999
f23	Code transmit time	ms	0-99.9999999
f24	Doppler measurement	10 (-4) Hz	±99999.99999
f25	Range smoothing correction. Raw range minus smoothed range	meters	0-99.99
d26	Range smoothing quality		0-200
PL2 Code Data Block			
d27	Warning flag (see Table 6.80)		0-255
d28	Good/bad flag (see Table 6.81)		22-24
d29	5 for backward compatibility		5
d30	Signal to noise indicator	dB Hz	30-60
d31	spare		
f32	Full carrier phase	cycles	0-999999999.999
f33	Code transmit time	ms	0-99.9999999
f34	Doppler measurement	10 (-4) Hz	±99999.99999
f35	Range smoothing correction. Raw range minus smoothed range	meters	0-99.99
d36	Range smoothing quality		0-200
cc	Checksum Displayed in decimal. A bitwise exclusive OR (XOR) on all bytes from the sequence tag to the checksum (starts after MPC, and includes the last comma before the checksum).		

Table 6.80. Warning Flag Settings

Bits Index		Description of Parameter d ₇
1	2	Combination of bit 1 and bit 2
0	0	same as 22 in good/bad flag
0	1	same as 24 in good/bad flag
1	0	same as 23 in good/bad flag
3		carrier phase questionable

Table 6.80. Warning Flag Settings (continued)

Bits Index	Description of Parameter d_7
4	code phase (range) questionable
5	range not precise (code phase loop not settled)
6	Z tracking mode
7	possible cycle slip
8	loss of lock since last epoch

Table 6.81. Measurement Quality (Good/Bad Flag)

Value of d_8	Description
0	Measurement not available and no additional data will be sent
22	Code and/or carrier phase measured
23	Code and/or carrier phase measure, and navigation message was obtained but measurement was not used to compute position
24	Code and/or carrier phase measured, navigation message was obtained, and measurement was used to compute position



Only C/A is used for position computation, so this flag will never be more than 22 on Pcode measurements.

OUT: Enable/Disable Raw Data Output

\$PASHS,OUT,c1,(s2,s3,...),f4

The OUT command enables and disables continuous raw data output. The serial port *c* is mandatory, *s2* and *s3* specify the type string (Table 6.82), and *f4* the format. The raw data type string and the format are optional. If the command is sent without a format field, the data will be output in the format of the current setting of the port, if that format is available for that data type. A \$PASHS,OUT command overrides any previously sent \$PASHS,OUT commands.

To disable raw data output, issue the \$PASHS,OUT command without any data format strings.

Table 6.82. OUT Message Structure

Parameter	Description	Range
c1	Serial port	A - D
s2, s3	Raw data type string, may have one or more delimited by commas	MBN, PBN, SNV, CBN, CMR, DBN, EPB, SAL
f4	ASCII or binary format	ASC or BIN

Examples: Enable MBN, PBN, and SNV message in binary format on port C:

```
$PASHS,OUT,C,MBN,PBN,SNV,BIN <Enter>
```

Disable all raw data messages on port A:

```
$PASHS,OUT,A <Enter>
```

PBN: Position Data

\$PASHQ,PBN,c

Request PBEN data for one epoch, where *c* is the output port and is not required to direct the response message to the current communication port.

Example: Request PBN message to the current port:

```
$PASHQ,PBN <Enter>
```

\$PASHR,PBN

The response message may be in either ASCII or binary format. Position data in ASCII format is in the form:

```
$PASHR,PBN,f1,f2,f3,f4,m5,m6,f7,f8,f9,f10,d11,s12,d13,d14,d15,d16
```

*cc <Enter>

Table 6.83. PBN Message Structure (ASCII Format)

Parameter	Description	Range
f1	Receiver time with seconds of the week when code is received	0 - 604800.00
f2	Station position: ECEF-X (meters)	±9999999.9
f3	Station position: ECEF-Y (meters)	±9999999.9
f4	Station position: ECEF-Z (meters)	±9999999.9
m5	Latitude in degrees and decimal minutes (ddmm.mmmmm) Positive north.	±90
m6	Longitude in degrees and decimal minutes (dddmm.mmmmm) Positive east.	±180
f7	Altitude (meters)	-1000.000 to 18000.000
f8	Velocity in ECEF-X (m/sec).	500.00
f9	Velocity in ECEF-Y (m/sec).	500.00
f10	Velocity in ECEF-Z (m/sec).	500.00
d11	Number of satellites used for position computation.	3 -12
s12	Site name	4 char string
d13	PDOP	0 - 99
d14	HDOP	0 - 99
d15	VDOP	0 - 99
d16	TDOP	0 - 99
*cc	Checksum	

The response message in the binary format is in the form:

\$PASHR,PBN,<PBN structure> <Enter>

Table 6.84 describes the binary structure of the PBEN message.

Table 6.84. PBN Message Structure (Binary Format)

Parameter	Bytes	Significance	Units
long pbentime	4	GPS time when data was received.	10^{-3} seconds of week
char sitename	4	Site name	4 character

Table 6.84. PBN Message Structure (Binary Format) (continued)

Parameter	Bytes	Significance	Units
double navx	8	Station position: ECEF-X	meters
double navy	8	Station position: ECEF-Y	meters
double navz	8	Station position: ECEF-Z	meters
float navt	4	clock offset	meters
float navxdot	4	Velocity in ECEF-X	m/sec
float navydot	4	Velocity in ECEF-Y	m/sec
float navzdot	4	Velocity in ECEF-Z	m/sec
float navtdot	4	Clock drift	m/sec
unsigned short pdop	2	PDOP	
unsigned short chksum	2	checksum	
Total bytes	56		

RAW: Query Raw Data Parameter

\$PASHQ,RAW

This query will display the settings of all parameters related to raw data.

Example: \$PASHQ,RAW <Enter>

Return Message

The return message is shown below and described in Table 6.85.

```
RCI:020.0 MSV:03 ELM:10 ZEN_ELM:90 REC:Y MST:0
ANH:00.0000 ANA:00.0000 SIT:???? EPG:000 RNG:0
DRI: 020.0 DOI: 020.0
RAW: MBN PBN CBN SNV EPB SAL DBN DPC CMR FORMAT BAUD
PRTA: OFF OFF OFF OFF OFF OFF OFF OFF OFF ASCII 5
PRTB: OFF OFF OFF OFF OFF OFF OFF OFF OFF ASCII 5
PRTC: OFF OFF OFF OFF OFF OFF OFF OFF OFF ASCII 5
PRTD: OFF OFF OFF OFF OFF OFF OFF OFF OFF ASCII 5
```

Table 6.85. RAW Message Structure

Return Parameter	Description	Range	Default
RCI	Recording interval	0.1 - 999 seconds	20.0
MSV	Minimum number of Svcs for the data to be sent or recorded	1 - 9	3
ELM	Data elevation mask. The elevation below which measurement data from that satellite will not be output or recorded.	0 - 90 degrees	10
ZEN_ELM	Zenith elevation mask. Measurement data from satellites above this elevation will not be recorded or output	0 - 90 degrees	90
REC	Data recording to PCMCIA card	Y = Yes N = No (does not close file) E = Error (recording is Y but can't write to PC card at this point) S = Stop recording (closes file) F = Bad FAT D = Download in progress	Y
MST	Minimum satellites required for kinematic survey	0, 4 - 9	0
ANH	Antenna height	0.0000 to 64.0000 meters	0.0
ANA	Antenna height after survey	0.0000 to 64.0000 meters	0.0

Table 6.85. RAW Message Structure (continued)

Return Parameter	Description	Range	Default
SIT	Site ID	(4-character alphanumeric)	????
EPG	Epoch counter	0 - 999	0
RNG	Data mode which controls what data type is stored 0 = B-files 2 = C-files 4 = B and C files	0, 2, 4	0
DRI	Recording interval to the PCMCIA card	0.1 - 999.0 seconds	20.0
DOI	Output interval of raw data to the serial port	0.1 - 999.0 seconds	20.0
RAW	Raw data type	MBN, PBN, CBN, SNV, EPB, SAL, DBN, DPC, CMR	-
PRTA/ PRTB/ PRTC/ PRTD	Serial port	'ON', 'OFF'	OFF
BAUD	Baud rate index at each port	0-9 (see Table 6.42)	5
Format	Format setting of each port	ASCII, binary	ASCII



The raw data type DPC is for CGRS users only and is not documented in this manual.

RWO: Raw Data Output Settings

\$PASHQ,RWO,c

This command queries the raw data settings of port *c*, where *c* is A, B, C, or D. The output is sent to the current port.

Example: Query receiver for raw data setting of port C:

```
$PASHQ,RWO,C<Enter>
```

\$PASHR,RWO

The response message is in the form:

```
$PASHR,RWO,c1,d2,f3,d4,9(s5,d6,c7)*cc
```

where parameters *s5*, *d6*, and *c7* are repeated 9 times, once for each raw data message type.

Table 6.86 describes each parameter in an RWO message.

Table 6.86. RWO Message Structure

Parameter	Description	Range
c1	Port	A, B, C, D
d2	Baud rate code (see Table 6.42, page 124 for codes)	0 - 9
f3	RCI setting	0.0 - 999.0
d4	Number of raw data message settings to report	9
s5	Raw data message type	MBN, PBN, CBN, SNV, EPB, SAL,DBN, DPC, CMR
d6	Enabled/disabled flag. 0=disabled, 1=enabled	0, 1
c7	ASCII/binary setting. A= ASCII, B= binary	A, B

SAL: Almanac Data

\$PASHQ,SAL,c

Request for almanac data in Ashtech format, where *c* is the optional serial port.

Example: Query receiver for almanac data on current port.

```
$PASHQ,SAL <Enter>
```

\$PASHR,ALM

The response is a binary message in the form

\$PASHR,ALM,(almanac structure) <Enter>

This message only exists in binary format. If ASCII format is requested (default), only the header will be sent (\$PASHR, ALM).

The almanac message structure is defined in Table 6.87.

Table 6.87. ALM Message Structure

Type	Size	Contents
short	2	(Satellite PRN -1)
short	2	Health. see ICD-200 for description
float	4	e. Eccentricity
long	4	toe. Reference time for orbit (sec)
float	4	i0. Inclination angle at reference time (semi-circles).
float	4	OMEGADOT. Rate of right Asc. (semi-circles per sec).
double	8	(A) ^{1/2} . Square root of semi-major axis (meters ^{1/2}).
double	8	(OMEGA)0. Lon of Asc. node (semi-circles).
double	8	ω. Argument of Perigee (semi-circles)
double	8	M0. Mean anomaly at reference time (semi-circle).
float	4	af0. sec
float	4	af1. sec/sec.
short	2	almanac week number
short	2	GPS week number
long	4	Seconds of GPS week
unsigned short	2	Word checksum
Total bytes70		

SNV: Ephemeris Data

\$PASHQ,SNV,c

Request ephemeris data from receiver, where c is either the optional output serial or the specific PRN number. If either the port is specified, or if this field is left blank, the ephemeris structures for all available SVs will be output.

Example: Send out SNAV data for all available SVs to the current port.

\$PASHQ,SNV <Enter>

Send out SNAV data for PRN 10

\$PASHQ,SNV,10 <Enter>

\$PASHR,SNV

The response is in the form:

\$PASHR,SNV,<ephemeris structure> <Enter>



This message only exists in binary format. If ASCII format is requested (default), only the header will be sent (\$PASHR,SNV).

Table 6.88 describes the binary structure of the SNAV message.

Table 6.88. SNV Message Structure

Type	Size	Contents
short	2	Wn. GPS week number
long	4	Seconds of GPS week
float	4	Tgd. Group delay (sec)
long	4	lodc. Clock data issue
long	4	toc. second
float	4	af2. sec/sec ²
float	4	af1. sec/sec
float	4	af0. sec
long	4	IODE Orbit data issue
float	4	Δn. Mean anomaly correction (semi-circle/sec)
double	8	M0. Mean anomaly at reference time (semi-circle).
double	8	e. Eccentricity
double	8	(A) ^{1/2} . Square root of semi-major axis (meters ^{1/2}).
long	4	toe. Reference time for orbit (sec).
float	4	Cic. Harmonic correction term (radians).
float	4	Crc. Harmonic correction term (meters).
float	4	Cis. Harmonic correction term (radians).
float	4	Crs. Harmonic correction term (meters).
float	4	Cuc. Harmonic correction term (radians).
float	4	Cus. Harmonic correction term (radians).
double	8	(OMEGA)0. Lon of asc. node (semi-circles).

Table 6.88. SNV Message Structure (continued)

Type	Size	Contents
double	8	ω . Argument of perigee (semi-circles)
double	8	I0. Inclination angle at reference time (semi-circles).
float	4	OMEGADOT. Rate of right Asc. (semi-circles per sec).
float	4	IDOT. Rate of inclination (semi-circles per sec).
short	2	Accuracy
short	2	Health
short	2	Curve fit interval (coded).
char	1	(SV PRN number -1)
char	1	Reserved byte.
unsigned short	2	Word checksum
Total =	132 bytes	

NMEA Message Commands

The NMEA message commands control all query and set commands related to NMEA format messages and miscellaneous messages in an NMEA-style format. All standard NMEA messages are a string of ASCII characters delimited by commas. All messages are in compliance with NMEA 0183 Standards version 3.0, although they can also be output in both version 2.3 or in the format they historically have been in Ashtech receivers. (The version can be set using the `$PASHS,NME,TAG` command). All non-standard NMEA messages are a string of ASCII characters delimited by commas in the Ashtech proprietary format. Any combination of these messages can be output through different ports at the same time. In addition, you can set the output rate and the serial port independently for each message.

For each NMEA message type there is a **set** command, a **query** command and a **response** message. The **set** command is used to continuously output the NMEA response message. The period of the output is set by the `$PASHS,NME,PER` command, or by adding a period value at the end of the set command for the individual message. See “Set Commands” below for more details. The **query** command outputs an NMEA response only once.

Set Commands

The general structure of the NMEA set commands is:

```
$PASHS,NME,str,c,s [f] <Enter>
```

where str is a 3-character string that identifies the NMEA message to be output.

The available strings are:

ALM, CRT, DAL, DCR, DPO, GDG, GGA, GLL, GRS, GSA, GSN, GST, GSV, GXP, MSG, POS, PTT, RMC, RRE, SAT, TTT, UTM, VTG, XDR, and ZDA.

c is the serial port to which response message should be sent (A, B, C or D), and s is either ON or OFF. ON starts the message output. OFF disables the message.

f is an optional parameter that sets the send interval of the message in seconds. The range is 0.1 to 999 seconds.

The output rate of NMEA messages can be set individually for each message in each port, or as a single rate that will govern the output rate of all enabled messages. To set the output of all NMEA messages to the same send interval, issue the command `$PASHS,NME,PER,f`, where f is the send interval in seconds, with a range of 0.1 to 999 seconds. To set the output rate for an individual message, enter a value for the send interval (as described above) when enabling a particular message. For example, to output the SAT message on port A at 2-second intervals, issue the command `$PASHS,NME,SAT,A,ON,2`. Note

that if you send a \$PASHS,NME,PER command after setting the rate for an individual command, the PER command will override the rate set for the individual command on all ports.

When a set command is sent correctly, the receiver returns a \$PASHR,ACK (command acknowledge) message. If the command is sent incorrectly or the syntax is wrong, the receiver returns a \$PASHS,NAK (command not acknowledged) message. Once acknowledged, the receiver outputs the corresponding NMEA data message at the interval defined by the \$PASHS,NME,PER command, unless a necessary condition for the message to be output is not present. For example, the GRS message will not be output unless a position is being computed.

To disable all set NMEA messages, issue the \$PASHS,NME,ALL command.

To see what NMEA messages have been enabled, and at what interval, issue the \$PASHQ,PAR command.

Example: Enable the POS and GGA messages on port A at 5-second intervals, and enable the SAT message on port B at 10-second intervals:

```
$PASHS,NME,POS,A,ON<Enter>  
$PASHS,NME,GGA,A,ON<Enter>  
$PASHS,NME,PER,5<Enter>  
$PASHS,NME,SAT,B,ON,10<Enter>
```

Query Commands

The general structure of the NMEA query commands is:

```
$PASHQ,s,c <Enter>
```

where *s* is one of the 3 character NMEA strings and *c* is the serial port to which response message should be sent (A, B, C or D). The serial port field is optional. If a port is not included, the receiver will send the response to the current port. Unlike the set commands, the query command will initiate a single response message.

Example: Query POS message and send the response to port D

```
$PASHQ,POS,D <Enter>
```

Query GSA message and send the response to the current port.

```
$PASHQ,GSA <Enter>
```

Table 6.89 lists the NMEA data message commands. Only the set command for each NMEA message type is listed in the table, as the description for the set, query, and response message for each NMEA message are grouped together.

A detailed description of each NMEA command follows Table 6.89.

Table 6.89. NMEA Data Message Commands

Command	Description	Page
DISABLE OUTPUT		
\$PASHS,NME,ALL	Disable all messages	185
CHECK NMEA OUTPUT SETTINGS		
\$PASHQ,PAR	Query receiver parameters	114
\$PASHQ,NMO	Query NMEA message settings	222
NMEA VERSION		
\$SPASHS,NME,TAG	Set version of NMEA output	232
DIFFERENTIAL INFORMATION		
\$PASHS,NME,MSG	Enable/disable base station messages	217
EXTERNAL SENSORS		
\$PASHS,NME,XDR	Enable/disable external sensor information	238
OUTPUT RATE PARAMETER		
\$PASHS,NME,PER	Set output interval of NMEA response messages	223
PPS/PHOTOGRAMMETRY		
\$PASHS,NME,PTT	Enable/disable PPS pulse time tag message	225

Table 6.89. NMEA Data Message Commands (continued)

Command	Description	Page
\$PASHS,NME,TTT	Enable/disable event marker photogrammetry time tag message	233
POSITION INFORMATION		
PASHS,NME,GDC	Enable/disable GPS positions in grid coordinates	198
\$\$PASHS,NME,GGA	Enable/disable GPS position response message	202
\$PASHS,NME,GLL	Enable/disable lat/lon message	206
\$PASHS,NME,GXP	Enable/disable position computation with time of fix	215
\$PASHS,NME,POS	Enable/disable position message	223
\$PASHS,NME,RMC	Enable/disable recommended minimum GPS data	227
\$PASHS,NME,UTM	Enable/disable UTM coordinates message	234
\$PASHS,NME,CRT	Enable/disable Cartesian coordinates message	187
\$PASHS,NME,DPO	Enable/disable delta position message	195
\$PASHS,NME,DCR	Enable/disable delta cartesian message	194
RESIDUAL INFORMATION		
\$PASHS,NME,GRS	Enable/disable satellite range residual information	207
\$PASHS,NME,RRE	Enable/disable satellite residual and position error	228
SATELLITE INFORMATION		
\$PASHS,NME,ALM	Enable/disable almanac data	185
\$PASHS,NME,DAL	Enable/disable decimal almanac data	190
\$PASHS,NME,GSA	Enable/disable SVs used message	209
\$PASHS,NME,GSN	Enable/disable signal strength/satellite number	210
\$PASHS,NME,GSV	Enable/disable satellites in view message	213
\$PASHS,NME,SAT	Enable/disable satellite status message	231
TIME SYNC		
\$PASHS,NME,ZDA	Enable/disable time synchronization message	239
TRACK AND SPEED		
\$PASHS,NME,VTG	Enable/disable velocity/course message	236
ERROR STATISTICS		
\$PASHS,NME,GST	Enable/disable the pseudo-range error statistic message	213

ALL: Disable All NMEA Messages

\$PASHS,NME,ALL,c,OFF

Turn off all enabled NMEA messages, where c is the specified serial port. If the output rate is not set, the command is output at the rate set by the \$PASHS,NME,PER command.

Example: Turn off all NMEA message currently sent out through port B

```
$PASHS,NME,ALL,B,OFF <Enter>
```

ALM: Almanac Message

\$PASHS,NME,ALM,c,s,[f]

Enable/disable the almanac message where c is the receiver serial port, s is ON or OFF, and f is the optional output rate parameter in seconds. If the output rate is not set, the command is output at the rate set by the \$PASHS,NME,PER command..

Example: Enable ALM message on port C

```
$PASHS,NME,ALM,C,ON <Enter>
```

\$PASHQ,ALM,c

Query the almanac message, where c is the optional output port.

Example: Query almanac data message to receiver port D

```
$PASHQ,ALM,D <Enter>
```

\$GPALM

There will be one response message for each satellite in the GPS constellation. The response to the set or query command is in the form:

```
$GPALM,d1,d2,d3,d4,h5,h6,h7,h8,h9,h10,h11,h12,h13,h14,  
h15*cc <Enter>
```

Table 6.90. ALM Response Message

Parameter	Description	Range
d1	Total number of messages	01 -32
d2	Number of this message	01 -32
d3	Satellite PRN number	01 - 32
d4	GPS week	4 digits
h5	SV health (In ASCII Hex)	2 bytes
h6	e. Eccentricity (In ASCII Hex)	4 bytes
h7	toe. Almanac reference time (seconds. In ASCII Hex)	2 bytes

Table 6.90. ALM Response Message (continued)

Parameter	Description	Range
h8	Io. Inclination angle (semicircles. In ASCII Hex)	4 bytes
h9	OMEGADOT. Rate of ascension (semicircles/sec. In ASCII Hex)	4 bytes
h10	A ^{1/2} . Square Root of semi-major axis (Meters & 1/2 In ASCII Hex)	6 bytes
h11	ω. Argument of perigee (semicircle. In ASCII Hex)	6 bytes
h12	OMEGA0. Longitude of ascension mode (semicircle. In ASCII Hex)	6 bytes
h13	Mo. Mean anomaly (semicircle. In ASCII Hex)	6 bytes
h14	afo. Clock parameter (seconds. In ASCII Hex)	3 bytes
h15	af1. Clock parameter (sec/sec. In ASCII Hex)	3 bytes
*cc	Checksum	

Example:

Query: \$PASHQ,ALM <Enter>

Response:

\$GPALM,26,01,01,0899,00,1E8C,24,080B,FD49,A10D58,EB4562,
BFEF85,227A5B,011,000*0B <Enter>

Table 6.91 describes a typical ALM response message.

Table 6.91. Typical ALM Response Message

Item	Significance
\$GPALM	Header
26	Total number of messages
01	Number of this message
01	Satellite PRN Number
0899	GPS week number
00	Satellite Health
1E8C	Eccentricity
24	Almanac Reference Time
080B	Inclination angle
FD49	Rate of ascension
A10D58	Root of semi-major axis
EB4562	Argument of perigree
BFEF85	Longitude of ascension mode
227A5B	Mean anomaly
011	Clock parameter
000	Clock parameter
*0B	checksum

CRT: Cartesian Coordinates Message

\$PASHS,NME,CRT,c,s,[f]

This command enables/disables the output of the cartesian coordinates message, where c is the port, s is ON or OFF, and f is an optional output rate parameter in seconds. If the output rate parameter is not set, the command will be output at the rate set by the \$PASHS,NME,PER command. If no position is computed, the

message will be output with the position related fields empty.

Example: Enable CRT message on port B:

```
$PASHS,NME,CRT,B,ON<Enter>
```

\$PASHQ,CRT,c

Query the CRT message, where c is the optional output serial port.

Example: Query receiver for Cartesian coordinate message to current port:

```
$PASHQ,CRT <Enter>
```

\$PASHR,CRT

The response message is in the form:

```
$PASHR,CRT,d1,d2,m3,f4,f5,f6,f7,f8,f9,f10,f11,f12,f13,f14,f15,s16,*cc
```

where the fields are as defined in Table 6.92.

Table 6.92. CRT Message Structure

Parameter	Description	Range
d1	Raw/differential position 0: Raw, position is not differentially corrected 1: Position is differentially corrected with RTCM code 2: Position is differentially corrected with CPD float solution 3: Position is CPD fixed solution	0-3
d2	Number of SVs used in position computation.	3 to 12
m3	UTC time: hhmmss.ss	00 to 23:59:59.99
f4	ECEF X coordinate (meters): [-]xxxxxxx.xxx	± 9999999.999
f5	ECEF Y coordinate (meters): [-]xxxxxxx.xxx	± 9999999.999
f6	ECEF Z coordinate (meters): [-]xxxxxxx.xxx	± 9999999.999
f7	Receiver clock offset (meters) [-]x.xxx	± 9.999
f8	Velocity vector, X-component (meters/sec): [-]x.xxx	± 9.999
f9	Velocity vector, Y-component (meters/sec): [-]x.xxx	± 9.999
f10	Velocity vector, Z-component (meters/sec): [-]x.xxx	± 9.999
f11	Receiver clock drift (meters) [-]x.xxx	± 9.999
f12	PDOP - position dilution of position	0 to 99.9
f13	HDOP - horizontal dilution of position	0 to 99.9
f14	VDOP - vertical dilution of position	0 to 99.9
f15	TDOP - time dilution of position	0 to 99.9
s16	Firmware version ID	4-character string
*cc	Checksum	

DAL: DAL Format Almanac Message

\$PASHS,NME,DAL,c,s,[f]

This message displays the NMEA almanac message in decimal format, where c is the port, s is ON or OFF, and f is the optional output rate parameter in seconds. If the output rate is not set, the command is output at the rate set by the \$PASHS,NME,PER command.

Example: Enable DAL message on port A:

```
$PASHS,NME,DAL,A,ON <Enter>
```

\$PASHQ,DAL,c

There are 2 formats of the \$PASHQ,DAL query. One format outputs the almanac information for all available satellites in the GPS constellation, one response message for each satellite. The other format allows you to output the almanac for only a single satellite.

\$PASHQ,DAL,c

Queries the receiver for almanac information for all available satellites where c is the optional output serial port.

Example: Query all available almanac messages. Send output to port D.

```
$PASHQ,DAL,D <Enter>
```

\$PASHQ,DAL,d

Queries the receiver for almanac information from a single satellite, where d is the PRN number of the desired satellite. The response will be sent to the current port.

Example: Query the almanac information for PRN #15:

```
$PASHQ,DAL,15 <Enter>
```

\$PASHR,DAL

Depending upon the chosen query format, there will be one response message or many, but there will be only one response message for each satellite. The response message is in the form shown below and described in Table 6.93.

```
$GPDAL,d1,d2,f3,f4,f5,f6,f7,f8,f9,f10,f11,f12,d13*cc <Enter>
```

Table 6.93. DAL Message Structure

Parameter	Description	Range
d1	Satellite PRN number	1 - 32
d2	Satellite health	0 - 255
f3	e. Eccentricity	$\pm 9.9999999E\pm 99$
d4	toe, reference time for orbit (in seconds)	0 - 999999
f5	i0, inclination angle at reference time (semicircles)	0 - 9.9999999E ± 99

Table 6.93. DAL Message Structure (continued)

Parameter	Description	Range
f6	omegadot, the rate of right ascension (semicircles/sec)	$\pm 9.9999999E\pm 99$
f7	roota, the square root of semi-major axis (meters $^{1/2}$)	0 - 9.9999999E ± 99
f8	omega0, the longitude of the ascension node (semicircle)	$\pm 9.9999999E\pm 99$
f9	ω , the argument of perigee (semicircle)	$\pm 9.9999999E\pm 99$
f10	M0, the mean anomaly at reference time (semicircle)	$\pm 9.9999999E\pm 99$
f11	af0, clock parameter (in seconds)	$\pm 9.9999999E\pm 99$
f12	af1, clock parameter (sec/sec)	0 - 9.9999999E ± 99
d13	wn, GPS almanac week number	4 digits
*cc	checksum in hex	hex

Example:

Query: \$PASHQ,DAL <Enter>

Typical DAL response message:

\$PASHR,DAL,01,00,3.7240982E03,061440,3.0392534E-01,
-2.5465852E-09,5.1536646E03,1.6172159E-01,-5.0029719E-01,
2.7568674E-01,1.6212463E-05,0.0000000E00,0899*51 <Enter>

Table 6.94 describes the typical DAL response message.

Table 6.94. Typical DAL Message

Item	Significance
\$PASHR,DAL	Header
01	Satellite PRN number
00	Satellite health
3.7240982E03	Eccentricity
061440	Reference time for orbit
3.0392534E-01	Inclination angle
-2.5465852E-09	Rate of right ascension
5.1536646E03	Square root of semi-major axis
-1.6172159E-01	Argument of perigree
-5.0029719E-01	Longitude of ascension node
2.7568674E-01	Mean anomaly
1.6212463E-05	Clock parameter
0.0000000E00	Clock parameter
0899	GPS week number
*51	Checksum

DCR: Delta Cartesian Message

\$PASHS,NME,DCR,c,s,[f]

This command enables/disables the output of the delta Cartesian message, where s is the port, c is ON or OFF, and f is an optional output rate parameter in seconds. If the output rate parameter is not set, the command is output at the rate set by the \$PASHS,NME,PER command.

Example: Enable DCR message on port D:

```
$PASHS,NME,DCR,D,ON<Enter>
```

\$PASHQ,DCR,[c]

Query the DCR message, where c is the optional output serial port.

Example: Query DCR message output to port A:

```
$PASHQ,DCR,A<Enter>
```

\$PASHR,DCR

The DCR response message is in the form:

```
$PASHR,DCR,c1,d2,m3,f4,c5,f6,c7,f8,c9,f10,f11,f12,f13,f14,f15,f16,s17*cc
```

where the parameters are as defined in Table 6.95.

Table 6.95. DCR Message Structure

Parameter	Description	Range
c1	Mode: M = manual, A = automatic	M or A
d2	Number of SVs used in position computation	3 to 12
m3	UTC time: hhmmss.ss	00 to 23:59:59.99
f4	Delta antenna position ECEF X coordinate in meters: [-]x.xxx	± 9.999
f5	Delta antenna position ECEF Y coordinate in meters: [-]x.xxx	± 9.999
f6	Delta antenna position ECEF X coordinate in meters: [-]x.xxx	± 9.999
f7	Receiver clock offset in meters: [-]x.xxx	± 9.999
f8	Velocity vector, X component, in meters/sec: [-].xxx	± 0.999
f9	Velocity vector, Y component, in meters/sec: [-].xxx	± 0.999
f10	Velocity vector, X component, in meters/sec: [-].xxx	± 0.999
f11	Receiver clock drift in meters: [-]x.xxx	± 9.999
f12	PDOP: Position Dilution of Precision	0-99.9
f13	HDOP: Horizontal Dilution of Precision	0-99.9
f14	VDOP: Vertical Dilution of Precision	0-99.9
f15	TDOP: Time Dilution of Precision	0-99.9
s16	Firmware version ID	4-character string
*cc	Checksum	

DPO: Delta Position Message

\$PASHS,NME,DPO,c,s,[f]

This command enables/disables the output of the delta position message, where c is the port, s is ON or OFF, and f is an optional output rate parameter in seconds. If the output rate parameter is not set, the command is output at the rate set by the \$PASHS,NME,PER command. The DPO message outputs the computed vector solution in northing, easting, and up coordinates. If no position is computed, the message is output with the position related fields empty.

Example: Enable DPO message on port A:

```
$PASHS,NME,DPO,A,ON<Enter>
```

\$PASHQ,DPO,c

Query the DPO message where c is the optional output serial port.

Example: Query the DPO message output to port A:

```
$PASHQ,CRT,A <Enter>
```

\$PASHR,DPO

The DPO response message is in the form:

```
$PASHR,DPO,c1,d2,m3,f4,c5,f6,c7,f8,c9,f10,f11,f12,f13,f14,f15,f16,sl7*cc
```

where the message parameters are as defined in Table 6.96.

Table 6.96. DPO Message Structure

Parameter	Description	Range
c1	Mode: M = manual, A = automatic	M or A
d2	Number of SVs used in the position computation	3 to 12
m3	UTC time: hhmmss.ss	00 to 23:59:59.99
f4	Northing coordinate difference in meters: [-]xxxxxxx.xxx	± 9999999.999
c5	North: N	N
f6	Easting coordinate difference in meters: [-]xxxxxxx.xxx	± 9999999.999
c7	East: E	E
f8	Ellipsoid height difference in meters: xxxxx.xxx	± 99999.999
c9	Reserved	
f10	COG: course over ground in degrees: xxx.x	0 to 360
f11	SOG: speed over ground in meters/sec: xxx.x	0 to 999.9
f12	Vertical velocity in meters/sec [-]xxx.x	± 999.9
f13	PDOP: position dilution of precision	0 to 99.9
f14	HDOP: horizontal dilution of precision	0 to 99.9
f15	VDOP: vertical dilution of precision	0 to 99.9
f16	TDOP: time dilution of precision	0 to 99.9
s17	Firmware version ID	4-character string
*cc	Checksum	

GDC: User Grid Coordinate

\$PASHS,NME,GDC,c,s,[f]

This command enables/disables the output of grid coordinates on port c, where c is either A, B, C, or D, s is ON or OFF, and f is the optional output rate parameter in seconds. If the output rate is not set, the command is output at the rate set by the \$PASHS,NME,PER command.

If no position is being computed or GRD is not set to UDG, this message is not output.

\$PASHQ,GDC,c

Query grid coordinates where c is the optional output serial port. The message is not output unless position is being computed and GRD is set to UDG.

Example: Send GDC message to the current port:

```
$PASHQ,GDC <Enter>
```

\$PASHR,GDC

This message outputs the current position in the Grid Coordinate system selected by the user.

The response message is in the form:

```
$PASHR,GDC,m1,s2,f3,f4,d5,d6,f7,f8,M,f9,M,d10,s11,s12*cc <Enter>
```

Table 6.97. GDC Message Structure

Parameter	Description	Range
m1	UTC of position in hours, minutes, and decimal seconds (hhmmss.ss)	0—235959.90
s2	Map projection type	EMER/TM83/ OM83/LC83/ STER/LC27/ TM27/TMA7
f3	x (Easting) User Grid coordinate (meters)	±9999999.999
f4	y (Northing) User Grid coordinate (meters)	±9999999.999
d5	Position Indicator 1: Raw Position 2: RTCM differential, or CPD float position 3: Carrier Phase differential (CPD) fixed	1, 2, 3
d6	Number of GPS satellites being used	3 - 12
f7	Horizontal Dilution of Position (HDOP)	999.9
f8	Altitude in meters	-1000.000 to 18000.000

Table 6.97. GDC Message Structure (continued)

Parameter	Description	Range
M	Altitude units (M=meters)	M
f9	Geoidal separation in meters w.r.t. selected datum and Geoid Model	±999.999
M	Geoidal separation units (M-meters)	M
d10	Age of differential corrections	0-999
s11	Differential reference station ID	0-1023
s12	Datum type	See Appendix A
cc	checksum	



The altitude is either ellipsoidal (default) or geoidal (mean-sea-level) depending on the selection made with \$PASHS,HGT. The Geoidal separation when subtracted from the ellipsoidal altitude gives the geoidal altitude.

Example:

```
$PASHR,GDC,015151.00,EMER,588757.623,4136720.056,2,04,  
03.8,00012.123,M,-031.711,M,14,1010,W84*2A <Enter>
```

where the message parameters are as described in Table 6.98.

Table 6.98. Typical GDC Response Message

Item	Significance
015151.00	UTM time
EMER	Equatorial Mercator map projection
588757.623	User Grid easting coordinate (x)
4136720.056	User Grid northing coordinate (y)
2	RTCM differential position
04	Number of SVs used to compute position
03.8	HDOP
00012.123	Altitude of position
M	Altitude units (M=meters)
-031.711	Geoidal separation w.r.t. selected datum
M	geoidal separation units (M = meters)
014	age of corrections
1010	Differential Station ID
W84	Datum is WGS-84
*2A	checksum

GGA: GPS Position Message

\$PASHS,NME,GGA,c,s,[f]

This command enables/disables the GPS position message on port c, where c is either A, B, C, or D, s is ON or OFF, and f is the optional output rate parameter in seconds. If the output rate is not set, the command is output at the rate set by the \$PASHS,NME,PER command.. If no position is computed, the message will be output but the position related fields will be empty.

Example: Enable GGA on port A:

```
$PASHS,NME,GGA,A,ON <Enter>
```

\$PASHQ,GGA,c

Query the GPS position message where c is the receiver port where the message will be output. If no position is computed, the message will be output but the position related fields will be empty.

Example: \$PASHQ,GGA <Enter>

\$GPGGA

The GGA response message is in the form:

```
$GPGGA,m1,m2,c3,m4,c5,d6,d7,f8,f9,M,f10,M,f11,d12*cc <Enter>
```

Table 6.99. GGA Message Structure

Parameter	Description	Range
m1	Current UTC time of position fix in hours, minutes, and seconds (hhmmss.ss)	00-235959.90
m2	Latitude component of position in degrees and decimal minutes (ddmm.mmmmm)	0-90
c3	Direction of latitude N= North, S= South	N/S
m4	Longitudinal component of position in degrees and decimal minutes (dddmm.mmmmm)	0-180
c5	Direction of longitude E = East, W= West	E/W
d6	Position type 0. Position not available or invalid 1. Autonomous position 2. RTCM differential corrected position or CPD float position 3. CPD fixed position	0, 1, 2, 3
d7	Number of GPS satellites being used in the position computation	3 - 12
f8	Horizontal dilution of precision (HDOP)	0 - 99.9
f9	Geoidal Height (Altitude above mean sea level)	-1000.000 to 18000.000

Table 6.99. GGA Message Structure (continued)

Parameter	Description	Range
M	Altitude units M = meters	'M'
f10	Geoidal separation in meters	±999.999
M	Geoidal separation units M = meters	'M'
f11	Age of differential corrections (seconds)	0-999 (RTCM mode) 0-99 (CPD)
d12	Base station ID (RTCM only)	0-1023
*cc	checksum	



If the \$PASHS,NME,TAG command is set to V23 or V30, the d6 parameter (Position Type) is defined as follows:

- 0 = Fix invalid or not available
- 1 = GPS SPS Mode, fix valid
- 2 = Differential GPS, SPS Mode, fix valid
- 3 = GPS PPS Mode, fix valid
- 4 = Real Time Kinematic. Satellite system used in RTK mode with fixed integers
- 5 = Float RTK. Satellite system used in RTK mode, floating integers
- 6 = Estimated (dead reckoning) Mode
- 7 = Manual Input Mode
- 8 = Simulator Mode

This field will not be a null field.

Example: Query: \$PASHQ,GGA <Enter>

Typical response:

```
$GPGGA,015454.00,3723.285132,N,12202.238512,W,2,04,03.8,00012.123,  
M,-032.121,M,014,0000*75 <Enter>
```

Table 6.100 describes the parameters of the typical GGA response message.

Table 6.100. Typical GGA Message

Item	Description
\$GPGGA	Header
015454.00	UTC time
3723.285132	Latitude (ddmm.mmmmm)
N	North Latitude
12202.238512	Longitude (dddmm.mmmmm)
W	West longitude
2	RTCM differential position
04	Number of satellites used in position
03.8	HDOP
00012.123	Geoided height (altitude above mean-sea-level)
M	Units of altitude (M = meters)
-032.121	Geoidal separation
M	Units of geoidal separation (M=meters)
014	Age of correction
0000	Base station ID
*75	checksum

GLL: Latitude/Longitude Message

\$PASHS,NME,GLL,c,s,[f]

This command enables/disables the latitude/longitude response message, where c is port A, B, C, or D, s is ON or OFF, and f is the optional output rate parameter in seconds. If the output rate is not set, the command is output at the rate set by the \$PASHS,NME,PER command.

If no position is computed, the message will be output with the position-related fields empty.

Example: Enable GLL message on port A:

```
$PASHS,NME,GLL,A,ON <Enter>
```

\$PASHQ,GLL,c

Query GLL, where c is the optional output serial port.

Example: \$PASHQ,GLL <Enter>

\$GPGLL

The GLL response message is in the form:

```
$GPGLL,m1,c2,m3,c4,m5,c6*cc <Enter>
```

Table 6.101. GLL Message Structure

Parameters	Description	Range
m1	Position latitude in degrees and decimal minutes (ddmm.mmmmmm)	0 - 90°
c2	Direction of latitude N = North, S = South	N/S
m3	Position longitude in degrees and decimal minutes (dddmm.mmmmmm)	0 - 180°
c4	Direction of longitude W = West, E = East	W/E
m5	UTC time of position in hours, minutes, and seconds (hhmmss.ss)	00-235959.90
c6	Status: A = valid V = invalid	A/V
*cc	Checksum	



If the \$PASHS,NME,TAG command is set to V23 or V30, an additional field is added to the \$GPGLL message at the end of the message, before the checksum. This field is the Mode Indicator and is defined as follows:

A = Autonomous Mode

D = Differential Mode

E = Estimated (dead reckoning) Mode

S = Simulator Mode

N = Data not valid

The Status field (parameter c6) will be set to V (invalid) for all values of the Mode Indicator except A (autonomous) and D (differential).

Example: Query: \$PASHQ, GLL <Enter>

Typical response:

\$GPGLL,3722.414292,N,12159.852825,W,202556.00,A*12 <Enter>

Table 6.102 describes each item in a typical GLL response message.

Table 6.102. Typical GLL Message

Item	Significance
\$GPGLL	Header
3722.414292	Latitude
N	North latitude
12159.852825	Longitude
W	West longitude
202556.00	UTC time of position
A	Status valid
*12	checksum

GRS: Satellite Range Residuals

\$PASHS,NME,GRS,c,s,[f]

This command enables/disables the NMEA satellite range residual response message to port c, where c is A, B, C, or D, s is ON or OFF, and f is the optional output rate parameter in seconds. If the output rate is not set, the command is output at the rate set by the \$PASHS,NME,PER command.

If only four SVs are used in the position solution, residuals are not computed and GRS outputs zeroes in the residual fields. With three SVs or fewer, the message is not output.

Example: Enable GRS message on port C:

\$PASHS,NME,GRS,C,ON <Enter>

\$PASHQ,GRS,c

Query satellite range residual where c is the optional output serial port. The message is not output unless position is being computed.

Example: \$PASHQ,GRS <Enter>

\$GPGRS

The GRS response message is in the form:

\$GPGRS,m1,d2,n(f3)*cc <Enter>

where n is the number of satellites used in the position solution. Table 6.103

defines the GRS message structure.

Table 6.103. GRS Message Structure

Parameter	Description	Range
m1	Current UTC time of GGA position in hours, minutes, seconds (hhmmss.ss)	00-235959.90
d2	Mode used to compute range residuals 0: Residuals used to calculate position given in matching GGA line 1: Residuals re-computed after GGA position computed or post-fit residuals	0, 1
f3	Range residuals for satellite used in position computation. Order of residuals matches order of satellites in GSV message	±999.999
*cc	checksum	

 The range residuals are re-computed after the GGA position is computed, therefore the mode is always 1.

Example:

Query: \$PASHQ,GRS <Enter>

Typical response:

\$GPGRS,203227.50,1,-007.916,051.921,-048.804,-026.612,
-002.717,021.150*63 <Enter>

Table 6.104 describes each item in a typical GRS message.

Table 6.104. Typical GRS Message

Item	Significance
\$GPGRS	Header
203227.50	UTC time of GGA position
1	Residuals computed after GGA position was computed
-007.916	Range residuals of the first satellite
051.921	Range residuals of the second satellite
-048.804	Range residuals of the third satellite
-026.612	Range residuals of the fourth satellite
-002.717	Range residuals of the fifth satellite
021.150	Range residuals of the sixth satellite
*63	checksum

GSA: DOP and Active Satellite Messages

\$PASHS,NME,GSA,c,s,[f]

This command enables/disables the DOP and active satellite message to be sent out to serial port c, where c is port A, B, C, or D, s is ON or OFF, and f is the optional output rate parameter in seconds. If the output rate is not set, the command is output at the rate set by the \$PASHS,NME,PER command.

Example: Enable GSA message on port B:

```
$PASHS,NME,GSA,B,ON <Enter>
```

\$PASHQ,GSA,c

Query DOP and active satellites where c is the optional output serial port.

Example: Query GSA message to the current port:

```
$PASHQ,GSA <Enter>
```

\$GPGSA

The response message is in the form:

```
$GPGSA,c1,d1,d2,d3,d4,d5,d6,d7,d8,d9,d10,d11,d12,d13,f1,
f2,f3*cc <Enter>
```

where the parameters are as defined in Table 6.105.

Table 6.105. GSA Message Structure

Parameter	Description	Range
c1	Mode: M: manual A: automatic	M or A
d1	Mode: 1: fix not available 2: 2D 3: 3D	1 -3
d2 - d13	Satellites used in solution (null for unused channel)	1 -32
f1	PDOP	0 - 9.9
f2	HDOP	0 - 9.9
f3	VDOP	0 - 9.9
*cc	Checksum	

Example:

```
Query: $PASHQ,GSA <Enter>
```

Typical GSA response message:

```
$GPGSA,M,3,,02,,04,27,26,07,,,,,09,3.2,1.4,2.9*39 <Enter>
```

Table 6.106 describes a typical GSA response message.

Table 6.106. Typical GSA Message

Item	Significance
\$GPGSA	Header
M	Manual mode
3	3D mode
empty field	Satellite in channel 1
02	Satellite in channel 2
empty field	Satellite in channel 3
04	Satellite in channel 4
27	Satellite in channel 5
26	Satellite in channel 6
07	Satellite in channel 7
empty field	Satellite in channel 8
empty field	Satellite in channel 9
empty field	Satellite in channel 10
empty field	Satellite in channel 11
09	Satellite in channel 12
3.2	PDOP
1.4	HDOP
2.9	VDOP
*38	checksum

GSN: Signal Strength/Satellite Number

\$PASHS,NME,GSN,c,s,[f]

This command enables/disables the signal strength/satellite number response message on port c, where c is either A, B, C, or D, s is ON or OFF, and f is the optional output rate parameter in seconds. If the output rate is not set, the command is output at the rate set by the \$PASHS,NME,PER command.

Example: Enable GSN message on port C:

```
$PASHS,NME,GSN,C,ON <Enter>
```

\$PASHQ,GSN,c

Query signal strength message where c is the optional output serial port.

Example: Query GSN message on port A:

\$PASHQ,GSN,A <Enter>

\$GPGSN

The response message contains the GPS PRN number and corresponding signal strength for each locked satellite. The response message is in the form:

\$GPGSN,d1,n(d2,f3,)d4*cc <Enter>

where n is the number of locked satellites.

Table 6.107. GSN Message Structure

Field	Significance	Range
d1	Number of SVs locked	0 - 12
d2	PRN number	1 - 32
f3	Signal strength in DB Hz	30.0 - 60.0
d4	999 to end the message or RTCM age of corrections (if available)	999
*cc	Checksum	

Example:

Query: \$PASHQ,GSN <Enter>

Typical GSN response message:

\$GPGSN,04,02,46.5,04,48.4,07,50.8,09,51.2,999*7C <Enter>

Table 6.108 describes each item in a typical GSN message.

Table 6.108. Typical GSN Message

Item	Significance
\$GPGSN	Header
04	Number of SVs locked
02	PRN number of the first SV
46.5	Signal to noise of the first SV
04	PRN number of the second SV
48.4	Signal-to-noise ratio of the second SV
07	PRN number of the third SV
50.8	Signal-to-noise ratio of the third SV
09	PRN number of the fourth SV
51.2	Signal-to-noise ratio of the fourth SV

Table 6.108. Typical GSN Message (continued)

Item	Significance
999	Message termination
*7C	checksum

GST: Pseudo-range Error Statistic Message

\$PASHS,NME,GST,c,s,[f]

This command enables/disables the output of the pseudo-range error statistic message, where *c* is the port, *s* is ON or OFF, and *f* is the optional output rate parameter in seconds. If the output rate parameter is not set, the command is output at the rate set by the \$PASHS,NME,PER command.

Example: Enable GST message on port A:

```
$PASHS,NME,GST,A,ON<Enter>
```

\$PASHQ,GST,c

Query the GST message, where *c* is the optional output serial port.

Example: Query GST message output to the current port:

```
$PASHQ,GST<Enter>
```

\$PASHR,GST

The GST response message is in the form:

```
$PASHR,GST,m1,f2,f3,f4,f5,f6,f7,f8*cc
```

where the parameters are as defined in Table 6.109.

Table 6.109. GST Message Structure

Field	Significance	Range
\$PASHR,GST	Header	
m1	UTC time: hhmmss.ss	00 to 23:59:59.99
f2	RMS value of standard deviation of range inputs	0.00 to 99.999
f3	Standard deviation of semi-major axis of error ellipse (meters)	0.00 to 99.999
f4	Standard deviation of semi-minor axis of error ellipse (meters)	0.00 to 99.999
f5	Orientation of semi-major axis of error ellipse (degrees from true north)	0 to 180
f6	Standard deviation of latitude error (meters)	0.00 to 99.999
f7	Standard deviation of longitude error (meters)	0.00 to 99.999
f8	Standard deviation of altitude error (meters)	0.00 to 99.999
*cc	Checksum	

GSV: Satellites in View Message

\$PASHS,NME,GSV,c,s,[f]

This command enables/disables the satellites-in-view message to send out of serial port, where *c* is port A, B, C, or D, *s* is ON or OFF, and *f* is the optional

output rate parameter in seconds. If the output rate is not set, the command is output at the rate set by the \$PASHS,NME,PER command.

Example: Output GSV message on port A:

```
$PASHS,NME,GSV,A,ON <Enter>
```

\$PASHQ,GSV,c

Query satellites in view where c is the optional output serial port.

Example: Query the GSV message on port A:

```
$PASHQ,GSV,A <Enter>
```

\$GPGSV

The GSV response message is in the form:

```
$GPGSV,d1,d2,d3,n(d4,d5,d6,f7)*cc <Enter>
```

where n is maximum 4. If more than 4 satellites are tracked, a second message is sent, then a 3rd if more than 8 SVs are tracked. Each item is described in Table 6.110.

Table 6.110. GSV Message Structure

Field	Description	Range
d1	Total number of messages	1-3
d2	Message number	1-3
d3	Total number of satellites in view	1-12
d4	Satellite PRN	1-32
d5	Elevation in degrees	0-90
d6	Azimuth in degrees	0-359
f7	SNR in dB-Hz	30.0-60.0
*cc	checksum	

Example:

```
Query: $PASHQ,GSV <Enter>
```

Typical GSV response message:

```
$GPGSV,2,1,08,16,23,293,50.3,19,63,050,52.1,28,11,038,51.5,  
29,14,145,50.9*78 <Enter>
```

where each item is as described in Table 6.111.

Table 6.111. Typical GSV Message

Item	Significance
2	Total number of messages 1..3
1	Message number 1..3
8	Number of SVs in view 1..12
16	PRN of first satellite 1..32
23	Elevation of first satellite 0..90
293	Azimuth of first satellite 0...359
50.3	Signal-to-noise ratio of first satellite
19	PRN of second satellite
63	Elevation of second satellite
050	Azimuth of second satellite
52.1	Signal-to-noise ratio of second satellite
28	PRN of third satellite
11	Elevation of third satellite
038	Azimuth of third satellite
51.5	Signal-to-noise ratio of third satellite
29	PRN of fourth satellite
14	Elevation of fourth satellite
145	Azimuth of fourth satellite
50.9	Signal-to-noise of fourth satellite
*78	Checksum in hexadecimal

GXP: Horizontal Position Message

\$PASHS,NME,GXP,c,s,[f]

This command enables/disables the horizontal position message where c is either A, B, C, or D, s is ON or OFF, and f is the optional output rate parameter in seconds. If the output rate is not set, the command is output at the rate set by the \$PASHS,NME,PER command.

If no position is computed, this message is output but the position related fields will be empty.

Example: Output GXP message on port C

\$PASHS,NME,GXP,C,ON <Enter>

\$PASHQ,GXP,c

Query horizontal position where c is the optional output serial port.

Example: \$PASHQ,GXP,A <Enter>

\$GPGXP

The GXP response message is in the form:

\$GPGXP,m1,m2,c3,m4,c5*cc <Enter>

where the message structure is as defined in Table 6.112.

Table 6.112. GXP Message Structure

Parameter	Description	Range
m1	UTC of fix in hours, minutes and seconds (hhmmss.ss)	00-235959.90
m2	Latitude in degrees and decimal minutes (ddmm.mmmmmm)	0 - 90.00
c3	Direction of latitude N = North, S = South	N/S
m4	Longitude in degrees and decimal minutes (dddmm.mmmmmm)	0 - 180.00
c5	Direction of longitude E = East, W = West	W/E
cc	checksum	

Example:

Query: \$PASHQ,GXP <Enter>

Typical GXP response message:

\$GPGXP,212958.00,3722.396956,N,12159.849225,W*7A <Enter>

Table 6.113 describes each item in a typical GXP message.

Table 6.113. Typical GXP Message

Item	Significance
\$GPGXP	Header
212958.00	UTC time of position
3722.396956	Latitude
N	North Latitude
12159.849225	Longitude
W	West Longitude
*7A	checksum

MSG: Base Station Message

\$PASHS,NME,MSG,c,s,[f]

This command enables/disables the message containing RTCM reference (base) station message types 1, 2, 3, 6, and 16, 18, 19 where c is the output port, A, B, C, or D, s is ON or OFF, and f is the optional output rate parameter in seconds. If the output rate is not set, the command is output at the rate set by the \$PASHS,NME,PER command.



Unless the unit is sending or receiving differential corrections, this command is ignored.

Example: Enable MSG on port A:

```
$PASHS,NME,MSG,A,ON <Enter>
```

\$PASHQ,MSG,c

Query base station message where c is the optional output serial port. The message is not output unless differential corrections are being sent or received.

Example: \$PASHQ,MSG,C <Enter>

\$GPMSG

The response message will vary depending upon the type of message:

Message type 1 format:

```
$GPMSG,d1,d2,f3,d4,d5,d6,m7,n(d8,d9,f10,f11,d12)*cc <Enter>
```

Message type 2 format:

```
$GPMSG,d1,d2,f3,d4,d5,d6,m7,n(d8,d9,f10,f11,d12)*cc <Enter>
```

Message type 3 format:

```
$GPMSG,d1,d2,f3,d4,d5,d6,m7,f8,f9,f10*cc <Enter>
```

Message type 6 format:

```
$GPMSG,d1,d2,f3,d4,d5,d6,m7*cc <Enter>
```

Message type 16 format:

```
$GPMSG,d1,d2,f3,d4,d5,d6,m7,s8*cc <Enter>
```

Message type 18 format:

```
$GPMSG,d1,d2,f3,d4,d5,d6,m7,n(d8,d9,d10,d11,d12,d13,d14,d15)*cc  
<Enter>
```

Message type 19 format:

```
$GPMSG,d1,d2,f3,d4,d5,d6,m7,n(d8,d9,d10,d11,d12,d13,d14,f15)*cc  
<Enter>
```

Message type 20 format:

\$GPMSG,d1,d2,f3,d4,d5,d6,m7,n(d8,d9,d10,d11,d12,d13,d14,d15)*cc
<Enter>

Message type 21 format:

\$GPMSG,d1,d2,f3,d4,d5,d6,m7,n(d8,d9,d10,d11,d12,d13,d14,f15)*cc
<Enter>

Table 6.114 lists the common parts of messages 1, 2, 3, 6, 16, 18, 19, 20 and 21.

Table 6.114. Common Fields of Type 1, 2, 3, 6, 16, 18, 19, 20 and 21

Parameter	Description	Range
d1	RTCM message type	1,2,3,6,16,18, 19,20,21
d2	Station identifier	0 - 1023
f3	Z count	0 - 9999.9
d4	Sequence number	0 - 9
d5	Station health	0 - 7
d6	Total number of characters after the time item (include the comma and <Enter>)	0 - 999
m7	Current GPS time of position fix (hhmmss.ss)	00-235959.90

Table 6.115 lists the remainder of the type 1 message:

Table 6.115. Remainder of Type 1 Message

Parameter	Description	Range
d8	User differential range error (URDE)	0-9
d9	Satellite PRN number	1-32
f10	Pseudo range correction (PRC) in meters	±9999.99
f11	Range rate correction (RRC) in meters/sec	±9.999
d12	Issue of data ephemeris (IODE)	0-999
*cc	checksum	

Table 6.116 lists the remainder of message type 2

Table 6.116. Remainder of Type 2 Message

Parameter	Description	Range
d8	User differential range error (UDRE)	0-9
d9	Satellite PRN Number	1-32
f10	Delta Pseudo range correction (Delta PRC) in meters	± 99.99
f11	Delta Range rate correction (Delta RRC) in meters/sec	± 9.999
d12	Issue of data ephemeris (IODE)	0-999
*cc	checksum	

Table 6.117 lists the remaining message for type 3

Table 6.117. Remainder of Type 3 Message

Parameter	Description	Range
f8	Station X component	± 9999999.99
f9	Station Y component	± 9999999.99
f10	Station Z component	± 9999999.99
*cc	checksum	

Table 6.118 lists the remaining message for type 16

Table 6.118. Remainder of Type 16 Message

Parameter	Description	Range
s8	text message send from base receiver	Up to 80 alpha-numeric characters
*cc	checksum	

Table 6.119 lists the remainder for message type 18/20 (RTK carrier phase corrections)

size for type 18/20:

total number of svcs for L1 and L2 frequency $+2 \times (10 \text{ byte freq} + \text{GNSS}) + 3 \text{ byte}$

chksum + 2 byte <Enter>

Table 6.119. Remainder of Type 18 and 20 Messages

Parameter	Description	Range
d8	L1 or L2 frequency	00...01
d9	GPS time of measurement	0..599999 [µsec]
d10	Half/full L2 wavelength indicator	0 - full, 1 - half
d11	CA code /P code indicator	0 - CA, 1 -P
d12	SV prn	1..32
d13	Data quality	0..7 refer to RTCM spec. for table of phase errors
d14	Cumulative loss of continuity indicator	0..31
d15	Type 18 - carrier phase Type 20 - carrier phase correction	+/- 8388608 full cycles with resolution of 1/256 full cycle +/- 16777216 half cycles with resolution of 1/128 half cycle +/- 32768 full wavelengths with resolution 1/256 full wavelength +/- 65536 half wavelengths with resolution of 1/128 half wavelength

Table 6.120 lists the remainder of the type 19 message (uncorrected pseudorange measurements) and 21 (RTK pseudorange correction).

size for type 19 /21:

total number of SVs for L1 and L2 frequency + 2*(13 byte Freq+sm+GNSS) + 3 byte chksum + 2 byte <Enter>

Table 6.120. Remainder of Type 19 and 21 Messages

Parameter	Description	Range
d8	L1 or L2 frequency	00...01
d9	Smoothing interval	00 - 0..1 min 01 - 1..5 min 10 - 5..15 min 11 - indefinite

Table 6.120. Remainder of Type 19 and 21 Messages (continued)

Parameter	Description	Range
d10	GPS time of measurement	0..599999 [μ sec]
d11	CA code /P code indicator	0 - CA, 1 -P
d12	SV prn	1..32
d13	data quality	0..7 refer to RTCM spec. for table of pseudorange error
d14	multipath error	0..15 refer to RTCM spec. for table of multipath error
f15	type 19 - pseudorange type 21 - pseudorange correction	0..85899345.90 meters +/-655.34 [0.02 meter] when pseudorange scale factor is 0 +/-10485.44 [0.32 meter] when pseudorange scale factor is 1 (default)

Examples:

```
$GPMSG,01,0000,2220.0,1,0,127,003702.00,2,12,-0081.30,
0.026,235,2,13,0022.86,0.006,106,2,26,-0053.42,-0.070,
155,2,02,0003.56,+0.040,120,2,27,.0047.42,-0.004,145*cc <Enter>
$GPMSG,03,0000,1200.0,7,0,038,231958.00,-2691561.37,-4301271.02,
3851650.89*cc <Enter>
$GPMSG,16,0000,1209.6,5,0,036,23200.008,THIS IS A MESSAGE SENT
FROM BASE*cc <Enter>
```

NMO: NMEA Message Output Settings

\$PASHQ,NMO,c

This command queries the NMEA message settings of port c, where c can be A,B,C, or D. The output will be sent to the current port.

Example: Query the receiver for the NEMA message settings of port B:

```
$PASHQ,NMO,B <Enter>
```

\$PASHR,NMO

The NMO response message is in the form:

```
$PASHR,NMO,c1,d2,f3,d4,25(s5,f6)*cc
```

where parameters s5 and f6 are repeated 25 times, once for each NMEA message type.

Table 6.121 defines the parameters in an NMO message.

Table 6.121. NMO Message Structure

Parameter	Description	Range
c1	port	A, B, C, D
d2	Baud rate code (see Table 6.42, page 124, for codes)	0 - 9
f3	PER setting	0.0 - 999.0
d4	Number of NMEA messages settings to report	25
s5	NMEA message type	GLL, GXP, GGA, VTG, GSN, ALM, MSG, DAL, GSA, GSV, TTT, RRE, GRS, UTM, POS, SAT, XDR, GDC, RMC, PTT, ZDA, DPO, DCR, CRT, GST
f6	Output rate (seconds) 0=message is not enabled.	0 - 999.0

PER: Set NMEA Send Interval

\$PASHS,NME,PER,f

Set send interval of the NMEA response messages in seconds, where f is a value between 0.1 and 999. Values between 0.1 and 1 can be set at 0.1 second increments. Values between 1 and 999 can be set at 1 second intervals. Value 0.7 is not available.

Example: Output NMEA messages every 5 seconds:

```
$PASHS,NME,PER,5 <Enter>
```



If the fast data option (F) is installed, then PER can be set to 0.1 (10 Hz). If the fast data option is not installed, then PER can be set to 0.2 (5Hz) minimum.

POS: Position Message

\$PASHS,NME,POS,c,s,[f]

Enable/disable NMEA position response message on port c where c is port A, B, C or D, s is ON or OFF, and f is the optional output rate parameter in seconds. If the output rate is not set, the command is output at the rate set by the \$PASHS,NME,PER command.

If no position is being computed, a message will still be output but the corresponding position fields will be empty.

Example: Enable position message on port B:

```
$PASHS,NME,POS,B,ON <Enter>
```

\$PASHQ,POS,c

Query position message, where c is the optional output serial port.

Example: Send POS message to current port:

```
$PASHQ,POS <Enter>
```

\$PASHR,POS

The POS response message is in the form below and detailed in Table 6.122:

```
$PASHR,POS,d1,d2,m3,m4,c5,m6,c7,f8,f9,f10,f11,f12,f13,f14,f15,f16,
```

s17*cc <Enter>

Table 6.122. POS Message Structure

Parameter	Description	Range
d1	Raw/differential position 0: Raw; position is not differentially corrected 1: Position is differentially corrected with RTCM code 2: Position is differentially corrected with CPD float solution 3: Position is CPD fixed solution	0 - 3
d2	Number of SVs used in position fix	3 -12
m3	Current UTC time of position fix (hhmmss.ss)	00-235959.90
m4	Latitude component of position in degrees and decimal minutes (ddmm.mmmmmm)	0 - 90
c5	Latitude sector, N = North, S = South	N or S
m6	Longitude component of position in degrees and decimal minutes (dddmm.mmmmmm)	0 - 180
c7	Longitude sector E = East, W = West	W or E
f8	Altitude above selected datum in meters. For 2-D position computation this item contains the altitude held fixed.	-1000.000 to 18000.000
f9	reserved	
f10	True track/course over ground in degrees	0 - 359.9
f11	Speed over ground in knots	0 - 999.9
f12	Vertical velocity in decimeters per second	±999.9
f13	PDOP - position dilution of precision,	0 - 99.9
f14	HDOP - horizontal dilution of precision.	0 - 99.9
f15	VDOP - vertical dilution of precision.	0 - 99.9
f16	TDOP - time dilution of precision.	0 - 99.9
s17	Firmware version ID	4 char string
*cc	checksum	

 The altitude is either ellipsoidal (default) or geoidal (mean-sea-level) depending on the selection made with \$PASHS,HGT. The geoidal separation when subtracted from the ellipsoidal altitude gives the geoidal altitude.

Example:

Query: \$PASHQ,POS <Enter>

Typical POS response message:

```
$PASHR,POS,0,06,214619.50,3722.385158,N,12159.833768,W,00043.110,,
331.0,000.7,000.0,02.7,01.2,02.4,01.6,UC00*6C <Enter>
```

Table 6.123 describes each item in a typical POS message.

Table 6.123. Typical POS Message

Item	Significance
\$PASHR,POS	Header
0	Raw Position
06	Number of SVs used in position fix
214619.50	UTC time of position fix
3722.385158	Latitude
N	North latitude
121159.833768	Longitude
W	West longitude
00043.110	Altitude (meters)
empty field	Reserved
331.0	Course over ground (degrees)
000.7	Speed over ground (knots)
000.0	Vertical velocity (dm/sec)
02.7	PDOP
01.2	HDOP
02.4	VDOP
01.6	TDOP
UC00	Firmware version ID
*6C	checksum

PTT: Pulse Time Tag Message

\$PASHS,NME,PTT,c,s,[f]

Enable/disable output of PPS pulse time tag message, where c is the output port, s is ON or OFF, and f is the optional output rate parameter in seconds. If the output rate is not set, the command is output at the rate set by the \$PASHS,NME,PER command.

The response message is output as soon as possible after the PPS pulse is

generated (with minimum latency, < 50 ms if PPS offset is 0, otherwise < 150 ms), and contains the GPS time at which the latest PPS was sent, including the offset if an offset was set when the PPS pulse was enabled.

The period of the PTT message is independent of the NMEA period. It is only linked to the PPS period.

Example: Enable PTT message on port A:

```
$PASHS,NME,PTT,A,ON <Enter>
```

\$PASHQ,PTT,c

Query the time tag of the next PPS pulse, where c is the optional output port. If c is not specified, the reply is sent to the port on which the query was made.

The response will be sent out once, right after the next PPS pulse is generated, and contains the GPS time at which the PPS pulse was sent, including the offset if an offset was set when the PPS pulse was enabled. Thus the response may be delayed by one PPS period plus the time tag latency indicated above.

\$PASHR,PTT

The PTT response message is in the form:

```
$PASHR,PTT,d1,m2*cc <Enter>
```

where the message structure is as defined in Table 6.124.

Table 6.124. PTT Message Structure

Parameters	Description	Range
d1	Day of GPS week,	1 to 7, Sunday = 1
m2	GPS time in hours, minutes, seconds of the PPS pulse hh:mm:ss.sssssss	0 - 23:59:59.9999999

Typical PTT response message:

```
$PASHR,PTT,6,20:41:02.0000000*OD <Enter>
```

Table 6.125 describes a typical PTT response message.

Table 6.125. Typical PTT Response Message

Item	Description
6	Day of week (Friday)
20:41:02.0000000	GPS Time (8:41:02 PM)
*OD	Message checksum in hexadecimal

RMC: Recommended Minimum GPS/Transit

\$PASHS,NME,RMC,c,s,[f]

Enables/disables the recommended minimum specific GPS/Transit message, where c is the serial port, s is ON or OFF, and f is the optional output rate parameter in seconds. If the output rate is not set, the command is output at the rate set by the \$PASHS,NME,PER command.

Example: Enable RMC message on port C:

```
$PASHS,NME,RMC,C,ON <Enter>
```

\$PASHQ,RMC,c

Query recommended minimum GPS/transit message, where c is the optional output port.

\$GPRMC

The return message is in the form:

```
$GPRMC,m1,c2,m3,c4,m5,c6,f7,f8,d9,f10,c11*cc <Enter>
```

Table 3.6 defines the response message structure.

Table 6.126. RMC Message Structure

Parameter	Description	Range
m1	UTC time of the position fix (hhmmss.ss)	000000.00 - 235959.90
c2	Status	A = data valid V = navigation receiver warning
m3	Latitude (ddmm.mmmmmm)	0000.000000 -8959.999999
c4	Latitude direction	N = North S = South
m5	Longitude (dddmm.mmmmmm)	00000.000000 -17959.999999
c6	Longitude direction	E = East W = West
f7	Speed over ground, knots	000.0 - 999.9
f8	Course over ground, degrees true	000.0 - 359.9
d9	Date, ddmmyy	010100 - 311299
f10	Magnetic variation, degrees	0.0 - 99.9
c11	Direction of variation Easterly variation (E) subtracts from true course. Westerly variation (W) adds to true course	E = East W = West
*cc	Hexadecimal checksum	

If the \$PASHS,NME,TAG command is set to V23 or V30, an additional field is added to the \$GPRMC message at the end of the message, before the checksum. This field is the Mode Indicator and is defined as follows:

A = Autonomous Mode



D = Differential Mode
E = Estimated (dead reckoning) Mode
S = Simulator Mode
N = Data not valid

The Status field (parameter c2) of the \$GPRMC message will be set to V (navigation receiver warning) for all values of the Mode Indicator except A (autonomous) and D (differential). The Mode Indicator field will not be a null field.

Typical RMC response:

```
$GPRMC,213357.20,A,3722.410857,N,12159.773686,W,000.3,102.4,
290498,15.4,W*43 <Enter>
```

Table 6.127 describes a typical RMC response message.

Table 6.127. Typical RMC Response

Parameter	Description
213357.20	UTC time of the position fix (hhmmss.ss)
A	Valid position
3722.410857	Latitude ddmm.mmmmmm
N	North latitude
12159.773686	Longitude dddmm.mmmmmm
W	West longitude
000.3	Speed over ground, knots
102.4	Course over ground, degrees True
290498	Date, 29 April 1998
15.4	Magnetic variation, degrees
W	Westerly variation (W) adds to True course
*43	Hexadecimal checksum

RRE: Residual Error

\$PASHS,NME,RRE,c,s[f]

This command enables/disables the satellite residual and position error message to port c, where c is A, B, C, or D, s is ON or OFF, and f is the optional output rate parameter in seconds. If the output rate is not set, the command is output at the rate set by the \$PASHS,NME,PER command.

This message is not output unless a position is computed. If only 4 SVs are used in the position solution, residuals are not computed and RRE outputs zeroes in

the residual and position error fields. If 3 or less SVs are used, then no RRE message is output.

Example: Enable RRE message on port A:

```
$PASHS,NME,RRE,A,ON <Enter>
```

\$PASHQ,RRE,c

Query range residual message where c is the optional output serial port. The message is not output unless position is being computed.

Example: Send RRE message to Port A:

```
$PASHQ,RRE,A <Enter>
```

\$GPRRE

The response message is in the form:

```
$GPRRE,d1,n(d2,f3),f4,f5*cc <Enter>
```

where n = number of satellites used to compute a position

Table 6.128. RRE Message Structure

Parameter	Description	Range	Units
d1	Number of satellites used to compute position	3 - 12	n/a
d2	Satellite number (PRN Number)	1 - 32	n/a
f3	Range residual	± 999.9	meter
f4	RMS Horizontal position error	0 - 9999.9	meter
f5	RMS Vertical position error	0 - 9999.9	meter
*cc	Checksum		

Example:

```
Query: $PASHQ,RRE <Enter>
```

Typical RRE response message:

```
$GPRRE,04,23,8.4,28,-9.2,11,-2.2,17,3.2,34.4,49.7*0A <Enter>
```

Table 6.129 describes a typical RRE response message.

Table 6.129. Typical RRE Message

Item	Significance
04	Number of SVs used to compute a position
23	PRN number of the first SV
8.4	Range residual for the first SV

Table 6.129. Typical RRE Message (continued)

Item	Significance
28	PRN number of the second SV
-9.2	Range residual for the second SV
11	PRN number for the third SV
-2.2	Range residual for the third SV
17	PRN number for the fourth SV
3.2	Range residual for the fourth SV
34.4	Horizontal position error
49.7	Vertical position error
*0A	checksum

SAT: Satellite Status

\$PASHS,NME,SAT,c,s,[f]

This command enables/disables the satellite status message to port c, where c is A, B, C, or D, s is ON or OFF, and f is the optional output rate parameter in seconds. If the output rate is not set, the command is output at the rate set by the \$PASHS,NME,PER command.

Example: Enable SAT message on port B:

```
$PASHS,NME,SAT,B,ON <Enter>
```

\$PASHQ,SAT,c

Query satellite status where c is the optional output serial port.

Example: Send SAT message to port D:

```
$PASHQ,SAT,D <Enter>
```

\$PASHR,SAT

The response message is in the form shown below and detailed in Table 6.130:

```
$PASHR,SAT,d1,n(d2,d3,d4,f5,c)*cc <Enter>
```

where n = the number of SVs tracked.

Table 6.130. SAT Message Structure

Parameter	Description	Range
d1	Number of SVs locked	1 - 12
d2	SV PRN number,	1 - 32
d3	SV azimuth angle in degrees	0 - 359
d4	SV elevation angle in degrees	0 - 90
f5	SV signal/noise ratio in dB Hz	30.0-60.0
c	SV used in position computation 'U': used, '-' : not used	'U' / '-'
*cc	checksum	



The elevation/azimuth prior to the first computed position may be erroneous if the last position stored in battery back memory is very far from the current point.

Example:

```
Query: $PASHQ,SAT <Enter>
```

Typical SAT response message:

```
$PASHR,SAT,04,03,103,56,50.5,U,23,225,61,52.4,U,16,045,02,51.4,U,04,160,46,53.6,U*6E <Enter>
```

Table 6.131 describes each item in a typical SAT response message.

Table 6.131. Typical SAT Message

Item	Significance
\$PASHR,SAT	Header
04	Number of SVs locked
03	PRN number of the first SV
103	Azimuth of the first SV in degrees
56	Elevation of the first SV in degrees
50.5	Signal strength of the first SV
U	SV used in position computation
23	PRN number of the second SV
225	Azimuth of the second SV in degrees
61	Elevation of the second SV in degrees
52.4	Signal strength of the second SV
U	SV used in position computation
16	PRN number of the third SV
045	Azimuth of the third SV in degrees
02	Elevation of the third SV in degrees
51.4	Signal Strength of the third SV
U	SV used in position computation
04	PRN number of fourth SV
160	Azimuth of fourth SV in degrees
46	Elevation of fourth SV in degrees
53.6	Signal strength of fourth SV
U	SV used in position computation
*6E	Message checksum in hexadecimal

TAG: Set NMEA Version

\$PASHS,NME,TAG,s

This command sets the version of the standard NMEA messages, where s is a 3-

character string identifying the version, as listed in Table 6.132.

Table 6.132. NMEA Message Format Codes

s	NMEA Message Format Version
ASH	Consistent with previous versions (default)
V30	NMEA Version 3.0
V23	NMEA Version 2.3

In order to maintain backward compatibility, the ASH format outputs messages in a format consistent with previous versions.

Example: Set NMEA output format to Version 3.0:

```
$PASHS,NME,TAG,V30<Enter>
```

\$PASHQ,NME,TAG

This command queries the current setting of the NMEA output version format. The response message is sent to the current port.

\$PASHR,NME,TAG

The response message is in the form:

```
$PASHR,NME,TAG,s
```

where s is the 3-character string listed above in Table 6.132.

TTT: Event Marker

\$PASHS,NME,TTT,c,s,[f]

This command enables/disables the event marker message to port c, where c is A, B, C, or D, s is ON or OFF, and f is the optional output rate parameter in seconds. If the output rate is not set, the command is output at the rate set by the \$PASHS,NME,PER command.

This message outputs the GPS time (within 1 μ sec) when the pulse was received. This message is not output unless an event pulse is being input through the appropriate pin of port B and the event marker option (E) is available in the receiver. This message is therefore independent of the NMEA period (can be output faster or slower than the NMEA period depending on the period of the event).

Example: Enable TTT message on port A:

```
$PASHS,NME,TTT,A,ON <Enter>
```

There is no query command for TTT.

\$PASHR,TTT

The response message is in the form shown below and detailed in Table 6.133:

\$PASHR,TTT,d1,m2*cc <Enter>

Table 6.133. \$PASHR,TTT Message Structure

Parameter	Description	Range
d1	Day of the week. 1: Sunday, 7: Saturday	1 - 7
m2	GPS time tag in hours, minutes and seconds (hh:mm:ss.ssssss)	0 - 23:59:59.9999999
*cc	checksum	

Example: \$PASHR,TTT,3,18:01:33.1200417 *AC <Enter>

UTM: UTM Coordinates

\$PASHS,NME,UTM,c,s,[f]

This command enables/disables the output of the UTM coordinates on port c, where c is either A, B, C, or D, s is ON or OFF, and f is the optional output rate parameter in seconds. If the output rate is not set, the command is output at the rate set by the \$PASHS,NME,PER command.

If no position is being computed, this message is not output.

\$PASHQ,UTM,c

Query UTM coordinates where c is the optional output serial port. The message is not output unless position is being computed.

Example: Send UTM message to the current port:

\$PASHQ,UTM <Enter>

\$PASHR,UTM

The response message is in the form:

```
$PSHR,UTM,m1,m2,f3,f4,d5,d6,f7,f8,M,f9,M,d10,s11*cc <Enter>
```

where the structure is as defined in Table 6.134.

Table 6.134. UTM Message Structure

Parameter	Description	Range
m1	UTC of position in hours, minutes, and decimal seconds (hhmmss.ss)	0 - 235959.90
m2	Zone number for coordinates Zone letter for coordinates (N = north, S = south)	1-60, 99 'N', 'S'
f3	East UTM coordinate (meters)	±9999999.999
f4	North UTM coordinate (meters)	±9999999.999
d5	Position indicator. 1: Raw position 2: RTCM code differential, or CPD float solution 3: Carrier phase differential (CPD) fixed	1, 2, 3
d6	Number of GPS satellites being used	3 - 12
f7	Horizontal dilution of precision (HDOP)	999.9
f8	Altitude in meters	-1000.000 to 18000.000
M	Altitude units (M = meters)	M
f9	Geoidal separation in meters	±999.999
M	Geoidal separation units (M = meters)	M
d10	Age of differential corrections	0 - 999
s11	Differential reference station ID	4-character string
*cc	checksum	



The antenna altitude is either ellipsoidal (default) or geoidal (mean-sea-level) depending on the selection made with \$PASHS,HGT (see UCT section). The geoidal altitude can be also derived by subtracting the geoidal separation from the ellipsoidal altitude.

Example:

Query: \$PASHQ,UTM <Enter>

Typical UTM response message:

\$PASHR,UTM,015454.00,10S,588757.623,4136720.056,2,04,03.8,00012.123,M,-031.711,M,014,1010*3A <Enter>

Table 6.135 describes a typical UTM response message.

Table 6.135. Typical UTM Response Message

Parameter	Description
015454.00	UTC time
10S	UTM zone
588757.623	UTM easting coordinate
4136720.056	UTM northing coordinate
2	RTCM code differential position
04	Number of SVs used to compute position
03.8	HDOP
00012.123	Altitude
M	Altitude units (M = meters)
-031.711	Geoidal separation
M	Geoidal separation units (M = meters)
014	Age of corrections
1010	Differential station ID
*3A	Checksum

VTG: Velocity/Course

\$PASHS,NME,VTG,c,s,[f]

This command enables/disables the velocity/course message to port c, where c is A, B, C or D, s is ON or OFF, and f is the optional output rate parameter in seconds. If the output rate is not set, the command is output at the rate set by the \$PASHS,NME,PER command.

This message is not output unless position is computed.

Example: Enable VTG message on port B:

\$PASHS,NME,VTG,B,ON <Enter>

\$PASHQ,VTG,c

Query velocity/course where c is the optional output serial port. The message is not output unless position is being computed.

Example: Send VTG message to port C:

```
$PASHQ,VTG,C <Enter>
```

\$GPVTG

The response message is in the form shown below and detailed in Table 6.136:

```
$GPVTG,f1,T,f2,M,f3,N,f4,K*cc <Enter>
```

Table 6.136. VTG Message Structure

Parameter	Description	Range
f1	COG (Course Over Ground) true north	0 - 359.99
T	COG orientation (T = true north)	T
f2	COG magnetic north	0 - 359.99
M	COG orientation (M = magnetic north)	M
f3	SOG (Speed Over Ground)	0 - 999.99
N	SOG units (N = knots)	N
f4	SOG (Speed Over Ground)	0 - 999.99
K	SOG units (K = Km/hr)	K
*cc	checksum	



If the \$PASHS,NME,TAG command is set to V23 or V30, an additional field is added to the \$GPVTG message at the end of the message, before the checksum. This field is the Mode Indicator and is defined as follows:

A = Autonomous Mode

D = Differential Mode

E = Estimated (dead reckoning) Mode

S = Simulator Mode

N = Data not valid

The Mode Indicator will not be a null field.

Example:

```
Query: $PASHQ,VTG <Enter>
```

Typical VTG response message:

```
$GPVTG,004.58,T,349.17,M,000.87,N,001.61,K*46 <Enter>
```

Table 6.137 describes each item in a typical VTG message.

Table 6.137. Typical VTG Message

Parameter	Significance
\$GPVTG	Header
004.58	Course over ground (COG) oriented to true north
T	True north orientation
349.17	Course over ground (COG) oriented to magnetic north
M	Magnetic north orientation
000.87	Speed over ground (SOG) in knots
N	SOG units (N=knots)
001.61	Speed over ground (SOG) in km/hr
K	SOG units (K=km/hr)
*46	checksum

XDR: Transducer Measurements

\$PASHS,NME,XDR,c,s,[f]

Enable/disable the transducer measurements message, where c is the output port, s is ON or OFF, and f is the optional output rate parameter in seconds. If the output rate is not set, the command is output at the rate set by the \$PASHS,NME,PER command.

This message transfers the XDR message received from external transducers (through \$WIXDR and \$YXXDR NMEA message or Ashtech format \$PASHS,XDR) for use by the control station, so that the control station can have access to all measurements, GPS data, and transducer data through a single communication link.

Example: Enable XDR message on port A::

```
$PASHS,NME,XDR,A,ON <Enter>
```

\$PASHQ,XDR,c

Query transducer measurements, where c is the optional output port and is not required to direct the response to the current port.

Example: Send query of XDR message on port A:

```
$PASHQ,XDR,A <Enter>
```

\$GPXDR

As indicated above, the format of the response is the same as the format of the

input from the transducer (\$WIXDR and \$YXXDR). The messages are in the form:

\$GPXDR,c1,f2,c3,s4, c5,f6,c7,s8,..., c n,f n+1,c n+2,s n+3*cc <Enter>

The data from the transducers have the form c1,f2,c3,s4, as defined in Table 6.138. Several transducer data can be sent in the same message as long as the entire string is not longer than 180 characters.

Table 6.138. XDR Message Structure

Parameter	Description	Range
c1	Transducer type	A - Angular displacement C - Temperature D - Linear displacement F - Frequency G - Generic H - Humidity I - Current N - Force P - Pressure R - Flow rate S - Switch or valve T - Tachometer U - Voltage V - Volume
f2	Transducer value	+/- x.x (variable < 30 char)
c3	Transducer units	type A : D - Degress type C : C - Celsius type D : M - Meters type F : H - Hertz type G : Null - none type H : P - Percent type I : A - Amperes type N : N - Newton type P : B - Bars type R : L - Liters type S : null - none type T : R - RPM type U : V - Volts type V : M - Cubic meters
s4	Transducer ID	Variable length (< 80 char)
*cc	Checksum	

ZDA: Time and Date

\$PASHS,NME,ZDA,c,s,[f]

Enable/disable the time and date message, where c is the output port, s is ON or OFF, and f is the optional output rate parameter in seconds. If the output rate is not set, the command is output at the rate set by the \$PASHS,NME,PER command.

This message is output even if a position is not computed.

Example: Disable ZDA message on port A:

```
$PASHS,NME,ZDA,A,OFF <Enter>
```

\$PASHQ,ZDA,c

Query time and date, where c is the optional output port and is not required to direct the response to the current port.

Example: Send query of ZDA message on port A:

```
$PASHQ,ZDA,A <Enter>
```

\$GPZDA

The response message is in the form shown below and defined in Table 6.139.

```
$GPZDA,m1,d2,d3,d4,d5,d6*cc <Enter>
```

Table 6.139. ZDA Message Structure

Parameter	Description
m1	UTC time (hhmmss.ss) (hours, minutes, seconds)
d2	Current day 01 - 31
d3	Current month 01 - 12
d4	Current year 0000-9999
d5	Local zone offset from UTC time where s = sign and hh = hours Range 00 - ±13
d6	Local zone offset from UTC time where mm = minutes with same sign as hh
*cc	Checksum

Typical Example:

```
$GPZDA,132123.00,10,03,1998,-07,-20*22 <Enter>
```

Table 6.140 describes a typical ZDA response message.

Table 6.140. Typical ZDA Response Message

Parameter	Description
\$GPZDA	Message header
123123.00	UTC time
10	Current day
03	Current month
1998	Current year
-07	Local zone offset (hours)
-20	Local zone offset (min)
*22	Checksum in hexadecimal

RTCM Response Message Commands

The RTCM commands allow you to control and monitor RTCM real-time differential operations. The RTCM commands are only available if the differential options are installed in the receiver. If the Base Station option (B) is installed, then only the base parameter and general parameter commands are accessible. If the Remote option (U) is installed, then only the remote parameter and general parameter commands are available. For a more detailed discussion of RTCM differential, refer to the RTCM differential section of the Operations chapter.

Set Commands

All RTCM commands but one are set commands. Through the set commands you can modify and enable a variety of differential parameters. Certain set commands are applicable only to the base station and certain commands only apply to the remote station. If the set command is sent correctly, the receiver will respond with the \$PASHR,ACK acknowledgment. If a parameter is out of range or the syntax is incorrect, then the receiver will respond with a \$PASHR,NAK to indicate that the command was not accepted.

Query Commands

There is only one query command: \$PASHQ,RTC. Use this command to monitor the parameters and status of RTCM differential operations. The query command has an optional port field. If the query is sent with the port field left empty, then the response will be sent to the current port. If the port field contains a valid port (A-D), then the response will be output to that port. For example, the query:

```
$PASHQ,RTC <Enter>
```

outputs an RTCM status message to the current port. The command:

```
$PASHQ,RTC,C <Enter>
```

outputs an RTCM status message to port C.

Table 6.141 lists the RTCM commands.

Table 6.141. RTCM Commands

Command	Description	Page
BASE		
\$PASHS,RTC,BAS	Sets receiver to operate as differential base station	246
\$PASHS,RTC,EOT	Controls end of message characters	246
\$PASHS,RTC,MSG	Defines RTCM type 16 message	247
\$PASHS,RTC,IOD	Set ephemeris data update for RTCM base	247
\$PASHQ,RTC,MSI	Query RTCM message status	247
\$PASHS,RTC,SPD	Sets bit rate of base station	250
\$PASHS,RTC,STH	Sets health of base station	251
\$PASHS,RTC,TYP	Sets message type and message period	246
REMOTE		
\$PASHS,RTC,AUT	Turns auto differential mode on or off	246
\$PASHS,RTC,MAX	Sets maximum age of RTCM differential corrections	247
\$PASHS,RTC,QAF	Sets communication quality threshold	249
\$PASHS,RTC,REM	Sets receiver to operate as differential remote station	249
\$PASHS,RTC,SEQ	Checks sequence number of received messages	250
GENERAL		
\$PASHS,RTC,INI	Resets RTCM internal operation	246
\$PASHS,RTC,OFF	Disables differential mode	249
\$PASHS,RTC,STI	Sets station identification of base or remote	251
\$PASHQ,RTC	Requests differential mode parameters and status	243

Query: RTCM Status

\$PASHQ,RTC,c

Query RTCM differential status, where c is the optional serial port.

Example: Query receiver for RTCM status:

\$PASHQ,RTC, <Enter>

The return message is a free-form format. A typical response is shown below.

STATUS:

```

SYNC:*      TYPE:00      STID:0000      STHE:0
AGE:+0000   QA:100.00%  OFFSET:00

```

```

SETUP:
MODE:OFF  PORT:A  AUT:N  CODE: C/A
SPD:0300  STI:0000  STH:0  IOD: 030
MAX:0060  QAF:100  SEQ:N
TYP:      1  2  3  22  6  9  15  16 18/19  20/21  EOT
FRQ:      99 00 00 00 00 00 00 00 00 00 00  CRLF
MSG:

```

Table 6.142 describes the RTC response parameters.

Table 6.142. RTC Response Parameters

Return Parameter	Description	Range	Default
STATUS			
SYNC	status that denotes sync to last received RTCM message between Base and Remote stations. (Remote only) Set to “ ” if no corrections received for “max age”.	‘*’ - in sync	
TYPE	RTCM message type being sent (Base) or received (Remote). Type 9 applies only for remote.	1,2,3,6,9,15,16,18,19,20,21,22	
STID	Station ID received from the Base station	0 (any station) to 1023	
STHE	Station health received from the Base station.	0 - 7	
AGE	In Base mode, displays the elapsed time in seconds between the beginning of the transmission of Type 1,18/19 messages. In Remote mode, displays the age of the received messages in seconds.	0 - 999	
QA	Displays the communication quality factor between Base and Remote. Defined as (# of good measurements /QAF * 100 (Remote only)	0 - 100%	
OFFSET	Displays the number of bits from the beginning of the RTCM byte (in case of a bit slippage)		
SETUP			
MODE	RTCM mode	BAS, REM, OFF	OFF
PORT	Communication port	‘A’ , ‘B’ , ‘C’ or ‘D’	A
AUT	Automatic differential mode	N, Y	N
CODE	Indicated the code type used in differential	Always C/A	C/A

Table 6.142. RTC Response Parameters (continued)

Return Parameter	Description	Range	Default
SPD	RTCM bit rate. Indicate the speed at which differential collection are transmitted to the serial port.	25,50,100,110,150,200,250,300,1500,0 (burst mode)	300
STI	Station ID.	0 (any station) to 1023	0
STH	Station health	0-7	0
IOD	Ephemeris data update rate	0 - 90	30
MAX	Specifies the maximum age, in seconds, for which last corrections are still used, when no new corrections are received. (Remote only)	0 - 1199	60
QAF	Sets the criteria to be applied when evaluating the quality of communication between Base and Remote. (Remote only)	0 - 999	100
SEQ	Check for sequential received message number for the message to be accepted. (Remote only)	N, Y	N
TYP	RTCM message type that receiver will generate. (Base only)	1,2,3,6,16,15, 18, 19, 20, 21, 22	n/a
EOT	End of transmission character	CRLF, CR,NONE	CRLF
FRQ	RTCM message send frequency. The period is in seconds for type 1, 18/19, 20/21 and minutes for all other types. Type 6 is either ON or OFF.	99 - continuous 00 - disabled	Type 1 = 99 Type 6 = ON
MSG	For Base mode, it contains the message, up to 90 characters, that is sent from the base to the remote when message type 16 is enabled. In Remote mode, it displays the message, up to 90 characters, that is received from the Base.		

AUT: Auto Differential

\$PASHS,RTC,AUT,c

Turns auto differential mode on or off where c is Y (or ON) or N (or OFF). When in auto-diff mode, the receiver generates raw positions automatically if differential corrections are older than the maximum age, or are not available. This command is used to set the auto differential mode in CPD operation too. It is used only in REMOTE mode. Default is N (OFF).

Example: Turn auto differential mode on:

```
$PASHS,RTC,AUT,Y <Enter> or
```

```
$PASHS,RTC,AUT,ON <Enter>
```

BAS: Enable Base Station

\$PASHS,RTC,BAS,c

Set the receiver to operate as an RTCM differential base station, where c is the differential port A, B, C, or D.

Example: Set to differential base mode using port B:

```
$PASHS,RTC,BAS,B <Enter>
```

EOT: End of Transmission

\$PASHS,RTC,EOT,s

Control which characters to transmit at the end of each RTCM message, where s is the end of message parameter as detailed in Table 6.143. Default is 'CRLF'.

Table 6.143. EOT Parameters

Setting Parameter	Description	Range
s	nothing carriage return carriage return and line feed (default)	'NONE' 'CR' 'CRLF'

Example: Transmit only carriage return at end of every RTCM message:

```
$PASHS,RTC,EOT,CR <Enter>
```

INI: Initialize RTCM

\$PASHS,RTC,INI

Initialize RTCM internal operation. This should be issued to the RTCM base or remote station (or both) if communication link between base and remote is

disrupted.

Example: Initialize RTCM internal operation:

```
$PASHS,RTC,INI <Enter>
```

IOD: Ephemeris Data Update Rate

\$PASHS,RTC,IOD,d

This command sets the time period before the RTCM base station switches to a new issue of the ephemeris data (IODE), where d is the update rate and ranges from 0 - 90 seconds. Default is 30 seconds. The current setting of this parameter can be seen in the query command \$PASHQ,RTC.

This command, applicable to RTCM base mode only, determines how soon after receiving a new ephemeris update the base receiver will begin to use that data to compute corrections. The rover receiver will continue to use the old ephemeris until it receives RTCM corrections on the new IODE.

Example: Set base receiver to use new ephemeris data to compute corrections 20 seconds after the new ephemeris has been received:

```
$PASHS,RTC,IOD,20<Enter>
```

MAX: Max Age

\$PASHS,RTC,MAX,d

Set the maximum age in seconds of an RTCM differential correction above which it will not be used, where d is any number between 1 and 1199. Default is 60.

\$PASHS,RTC,MAX is used only in REMOTE mode.

Example: Set maximum age to 30 seconds:

```
$PASHS,RTC,MAX,30 <Enter>
```

MSG: Define Message

\$PASHS,RTC,MSG,s

Define RTCM type 16 message up to 90 characters long that will be sent from the base to the remote. **\$PASHS,RTC,MSG,s** is used only at the base station and only if message type 16 is enabled.

Example: Define RTCM message "This is a test message"

```
$PASHS,RTC,MSG,This is a test message <Enter>
```

MSI: Query RTCM Message Status

\$PASHQ,RTC,MSI,c

This command queries the base station for the current RTCM message type

settings, where c is the optional output serial port. This query responds with the RTCM message types and frequencies that are being transmitted. Used only with the base receiver.

Example: Query base receiver for RTCM message settings:

```
$PASHQ,RTC,MSI<Enter>
```

\$PASHR,RTC,MSI

The response message is in the form shown below and defined in Table 6.144.

```
$PASHR,RTC,MSI,d1,n(d2,d3)*cc (n = d1)
```

Table 6.144. RTC,MSI Message Structure

Parameter	Description	Range
d1	Number of RTCM types in message	11
d2	RTCM type	01,02,03,06,09,15,16,18,19,20,21,22
d3	Message frequency 0 = disabled 99 = continuous Units depend upon message type. See \$PASHS,RTC,TYP command on page 251.	0, 99

OFF: Disable RTCM

\$PASHS,RTC,OFF

Disables base or remote differential mode.

Example: Turn RTCM off:

```
$PASHS,RTC,OFF <Enter>
```

QAF: Quality Factor

\$PASHS,RTC,QAF,d

Sets the number of received differential correction frames in RTCM differential mode above which the quality factor is set to 100%, where d is any number between 0 and 999. This QAF number is used to compute the QA value where:

$$QA = \text{good messages} / QAF$$

The QA parameter allows you to evaluate the communication quality between the base and remote stations. Default is 100. **\$PASHS,RTC,QAF** is used only in REMOTE mode.

Example: Set quality factor to 200:

```
$PASHS,RTC,QAF,200 <Enter>
```

REM: Enable Remote RTCM

\$PASHS,RTC,REM,c

Set the receiver to operate as an RTCM differential remote station, where c is differential port A, B, C, or D.

Example: Set receiver to differential remote using port B:

```
$PASHS,RTC,REM,B <Enter>
```

SEQ: Check Sequence Number

\$PASHS,RTC,SEQ,c

Checks sequence number of received messages and, if sequential, accepts corrections; if not, don't use correction, where c is Y (check) or N (do not check). Default is N. **\$PASHS,RTC,SEQ** is used only in REMOTE mode. Valid only at beginning of differential operation. After two sequential RTCM corrections have been received, differential operation begins.

Example: Check sequence number:

```
$PASHS,RTC,SEQ,Y <Enter>
```

SPD: Base Bit Rate

\$PASHS,RTC,SPD,d

Set the number of bits per second that are being generated to the serial port of the base station, where d is the code for the output rate in bits per second. The available speeds and corresponding codes are listed in Table 6.145. Default is 300 bits per second. **\$PASHS,RTC,SPD** is used only in BASE mode.

Table 6.145. Available Bit Rate Codes

Code ►	0	1	2	3	4	5	6	7	8	9
Rate ►	25	50	100	110	150	200	250	300	150 0	0 (burst mode)

Example: Set bit rate to 110 bits/sec:

```
$PASHS,RTC,SPD,3 <Enter>
```

STH: Station Health

\$PASHS,RTC,STH,d

Set the health of the base station, where d is any value between 0 and 7. **\$PASHS,RTC,STH** is used only in BASE mode. Default is 0. Table 6.146 defines

the codes for the station health:

Table 6.146. RTC,STH Health of Base Station

Code	Health Indication
7	Base station not working.
6	Base station transmission not monitored.
5	Specified by service provider/UDRE scale factor = 0.1
4	Specified by service provider/UDRE scale factor = 0.2
3	Specified by service provider/UDRE scale factor = 0.3
2	Specified by service provider/UDRE scale factor = 0.5
1	Specified by service provider/UDRE scale factor = 0.75
0	Specified by service provider/UDRE scale factor = 1

Example: Set health to “Base station not working”:

```
$PASHS,RTC,STH,7 <Enter>
```



The station health is simply transmitted by the base, code 1 to 5 are not valid since the base and rover are using UDRE scale factor of 1 always.

STI: Station ID

\$PASHS,RTC,STI,d

This command sets the user station identification (user STID), where d is any integer value between 0000 and 1023. The STID is used to restrict the use of differential corrections to a particular base station. If the STID in the remote station is set to any non-zero number, then corrections will only be used from a base station with the same STID number. For example, if a remote station STID is set to 0987, then it will only use the differential corrections from a base station with an STID of 0987. If the remote station STID is set to 0000 (the default) then the station will use any differential corrections received, regardless of the STID of the base station.

Example: Set site identification to 0001:

```
$PASHS,RTC,STI,0001 <Enter>
```

TYP: Message Type

\$PASHS,RTC,TYP,d1,d2

Enables the type of message to be sent by the base station and the period at

which it will be sent, where d1 is the type and d2 is the period. **\$PASHS,RTC,TYP** is used only in BASE mode. Table 6.147 lists the message types available and the period range setting. The default is type 1 set to 99, and type 6 is ON.

Table 6.147. RTC,TYP Message Types

Type	Range
01	0-99 seconds, where 0 is disabled and 99 is generated continuously
02	0-99 minutes, where 0 is disabled and 99 is generated continuously
03	0-99 minutes, where 0 is disabled and 99 is generated continuously
06	1 = ON, 0 = OFF (ON and OFF are also accepted)
16	same as type 3
18/19	Same as type 1
20/21	Same as type 1
22	Same as type 3



All messages can be enabled simultaneously with any output period setting, with the exception of period 99; with simultaneous message, only one can be set at 99,

Example: Enable type 1, sent out every second:

`$PASHS,RTC,TYP,1,1 <Enter>`

CPD Commands

The CPD commands allow you to control and monitor CPD (Carrier Phase Differential) operations. The commands are either **general parameter** or **query** commands, **base set** commands or **rover set** commands. The base set commands are available only if the CPD base option (K) is installed, and the rover set commands are only available if the CPD Rover option (J) is installed in the receiver. In addition, using the base to output RTCM type 18/19 or 20/21 requires the B option (RTCM Diff. Base), and using the RTCM types in the rover requires the U option (RTCM Diff. Rover). When these options are enabled, the CMR format can also be used. For a more detailed discussion of CPD differential, refer to Chapter 4, *Understanding RTK/CPD*.

Set Commands

Through the set commands you can modify and enable a variety of CPD operating parameters. Certain set commands are applicable only to the base station and certain set commands only apply to the remote station. The general format of the set commands is:

```
$PASHS,CPD,s,c <Enter>
```

where *s* is the 3 character command identifier, and *c* is the parameter to be set. The only exception is command \$PASHS,RTC,AUT,N/Y which will be used to set the auto differential mode in both RTCM and CPD operation. If the set command is sent correctly, the receiver will respond with the \$PASHR,ACK acknowledgment. If a parameter is out of range or the syntax is incorrect, then the receiver will respond with a \$PASHR,NAK to indicate that the command was not accepted.

To use RTCM type 18/19 or 20/21, \$PASHS,RTC commands are also used. (See “RTCM Response Message Commands” on page 242).

Query Commands

The query commands are used to monitor the setting of individual parameters and the status of CPD operations. The general format of the query command is:

```
$PASHQ,CPD,s,c <Enter>
```

where *s* is the 3 character command identifier, and *c* is the port to which the response message will be output. The port field is optional. If the query is sent with the port field left empty, then the response will be sent to the current port. If the port field contains a valid port (A-D), then the response will be output to that port. For example, the query:

\$PASHQ,CPD <Enter>

will output a CPD status message to the current port. The query:

\$PASHQ,CPD,C <Enter>

will output a CPD status message to port C.

To use RTCM type 18/19 or 20/21, \$PASHS,RTC commands are also used. (See “RTCM Response Message Commands” on page 242).

Table 6.148. CPD Commands

Command	Description	Page
GENERAL SET COMMANDS		
\$PASHS,CPD,MOD	Set CPD mode	268
\$PASHS,CPD,CMR,ON/OFF	Enable/disable detection of CMR messages	260
GENERAL QUERY COMMANDS		
\$PASHQ,CPD	Query CPD related setting	256
\$PASHQ,CPD,CMR	Query status of CMR received mode (internal use only)	260
\$PASHQ,CPD,DLK	Query data link status	261
\$PASHQ,CPD,INF	Query CPD SV information	266
\$PASHQ,CPD,MOD	Query CPD mode settings	268
ROVER ONLY COMMAND		
\$PASHS,CPD,AFP	Set ambiguity fixing confidence parameter	259
\$PASHS,CPD,ANT	Set base antenna parameters from rover	259
\$PASHQ,CPD,ANT	Query base station antenna settings (from rover)	260
\$PASHS,RTC,AUT	Set auto-differential mode	246
\$PASHS,CPD,DYN	Set Rover dynamics	265
\$PASHS,CPD,FST	Enable/disable fast CPD mode	266
\$PASHS,CPD,MAX	Max Age for CPD Correction	268
\$PASHS,CPD,MTP	Set multipath parameter	269
\$PASHQ,OBN	Vector solution information	270
\$PASHS,CPD,OUT	Select solution to output	273
\$PASHS,CPD,PER	Set CPD update interval.	274
\$PASHS,CPD,POS	Set reference position of the base receiver from	275
\$PASHQ,CPD,POS	Query base position from rover	275
\$PASHS,RTC,REM	Set to receive RTCM type 18/19 or 20/21	249

Table 6.148. CPD Commands (continued)

Command	Description	Page
\$PASHS,CPD,RST	Reset the PNAV processing (Kalman filter reset)	276
\$PASHQ,CPD,STS	Query CPD Solution Status	276
\$PASHS,CPD,UBP	Select base position to use in rover mode	277
BASE-ONLY SET COMMANDS		
\$PASHS,RTC,BAS	Set RTCM base mode.	246
\$PASHS,CPD,PEB	Set broadcasting interval for base station position message,. either BPS (DBEN) or CMR type 1.	273
\$PASHS,CPD,PED	Set the DBN or CMR transmission period.	274
\$PASHS,CPD,ENT	Set current raw position as BASE position	265
\$PASHS,CPD,EOT	Select type of end-of-transmission message character(s) to send in DBN message	265
\$PASHS,CPD,PRO	Select DBN or CMR format	275
\$PASHS,CPD,PRT	Set port to output DBN and base position messages.	276
\$PASHS,RTC,TYP	Set output of RTCM type message (18/19 or 20/21)	251

CPD: RTK Status

\$PASHQ,CPD,c

This is the general CPD query command where c is the optional serial port. Use this query to monitor CPD settings and status.

Example: Query CPD parameters:

```
$PASHQ,CPD <Enter>
```

The response message is in free form format. A typical response appears as follows:

```
STATUS:  VERSION: PNAV_UL45,03/23/2002
MODE:DISABLED      BASE STAT: 00000
PRN:
AGE: 0000ms        RCVD CORD: 000 sec
AMBIGUITY: N/A     RCV INTVL: 01.0 sec  TYP:----
Dlf: 00000ms      Tf:00000 ms        DLc:00000 ms      Tc:00000 ms

SETUP:
DBEN PER:001.0sec          DBEN PORT: B EOT: CRLF
AMBIGUITY FIX MODE: 099.0%      MAX:AGE :0030sec AUT:N
DYNAMICS: WALKING DYNAMIC      POS OUTPUT: CPD   CKR:ON
MUTLIPATH: MEDIUM MULTIPATH    BAS POS USED: RECEIVED
FAST CPD: ON                  CPD PER: 01 sec IAF:ON
MESSAGE TYPE: DBN
PAF: OFF  AFM: 00  RNG: 040000  SCL: 0060  ION: N  LC: N
```

Table 6.149. CPD Status Message Structure

Parameter	Description	Range	Default
STATUS:			
MODE	CPD differential mode DISABLED BASE ROVER RVP BASE RVP ROVER		Disabled
VERSION	Version number and date of the CPD library.		

Table 6.149. CPD Status Message Structure (continued)

Parameter	Description	Range	Default
BASE STAT	status of base station operation in a 5-column array (A B C D E) A - '1' if receiver has not tracked L2 observables B - '1' if entered position and computed position differ by more that 500 meters in any direction C - '1' if base station has not computed position using raw pseudo-ranges D - '1' if base station antenna parameters are all zero E - '1' if base station coordinates are not entered. Useful only if Mode = Base	For each column - 0,1	00000
PRN	Lists the satellites' PRN ID in the transmitting DBEN messages or received DBEN message.	1-32	n/a
AGE	Display the DBEN message age in milliseconds. Always zero at the base.	0-9999	
RCVD COORD	Display age of received base station coordinates in seconds (from BPS message).	0-999	0
AMBIGUITY	Display ambiguity fix status (Rover)	Fixed/float	
RCV INTVL	Interval in seconds of DBEN message received (Rover)		01.0
TYP	Displays the message type received by the rover. (PASH=DBEN, CMR2=CMR, 1819=RTCM 18/19, 2021=RTCM20/21)	PASH, CMR2, 1819, 2021	n/a
Dif	Time delay to start fast CPD task (milliseconds)		N/A
Tf	Time to execute fast CPD task (Rover) (milliseconds)		N/A
Dlc	Time delay to start CPD (Rover) (milliseconds)		N/A
Tc	Time to execute CPD (Rover) (milliseconds)		N/A
SETUP			
DBEN PER	DBEN output period (Base)	0-5.0 ¹	1.0
DBEN PORT	DBEN output port (Base) or receiving port (Rover)	A-D	B
EOT	End-of-Transmission characters (Base)	CR/CRLF/ NONE	CRLF
AMBIGUITY FIX MODE	Confidence level of the ambiguity fix mode. 90.0 / 95.0 / 99.0 / 99.9		99.0
MAX AGE	Maximum age of base data will be used (sec)	0-30	30
DYNAMICS	(Rover) WALKING DYNAMIC / STATIC DYNAMIC / Q-STATIC DYNAMIC / AUTOMOBILE DYNAMIC / AIRCRAFT DYNAMIC / SHIP DYNAMIC		WALKING DYNAMIC

Table 6.149. CPD Status Message Structure (continued)

Parameter	Description	Range	Default
AUT	Auto-differential mode. If Y, rover will output code differential position if available, or stand-alone, if not, once the MAX AGE has been received.	Y/N	N
POS OUTPUT	Type of position for output (Rover)	CPD/RAW	CPD
MULTIPATH	(Rover) MEDIUM MULTIPATH / NO MULTIPATH / LOW MULTIPATH / HIGH MULTIPATH / SEVERE MULTIPATH		MEDIUM MULTI-PATH
BAS POS USED	Base position used (Rover)	RECEIVEDENTERED	RECEIVED
FAST CPD	Fast CPD algorithm (Rover)	ON, OFF	ON
CPD PER	CPD update period in seconds (Rover) Only relevant for fast CPD OFF	0 - 5.0 ¹	1.0
IAF	Reserved		
Message type	Message type sent by base receiver (Base only)	DBN,CMR	DBN
PAF	Reserved		
AFM	Reserved		
RNG	Reserved		
SCL	Reserved		
ION	Reserved		
LC	Reserved		
CKR	Reserved		
¹ The full range of the DBEN PER and CPD PER parameters (in seconds) is: 0.0, 0.2, 0.3, 0.4, 0.5, 0.6, 0.7, 0.8, 0.9, 1.0, 2.0, 3.0, 4.0, 5.0.			

AFP: Ambiguity Fixing

\$PASHS,CPD,AFP,f

This command sets the confidence level for ambiguity fixing, where f is the confidence level in percent. The higher the confidence level, the more certainty that the ambiguities are fixed correctly. But the longer it will take to fix them. The default is 99.0.

Table 6.150. CPD,AFP Parameter Table

Parameter	Description	Range
f	Ambiguity Fixing Parameter, i.e. the confidence levels for the reliability of the ambiguity fixed solution.	90.0 95.0 99.0 99.9

Example: Set the confidence level to 99.9:

```
$PASHS,CPD,AFP,99.9 <Enter>
```

ANT: Antenna Parameters

\$PASHS,CPD,ANT,f1,f2,f3,m4,f5

Sets the antenna parameters of base receiver from the rover receiver.



Since this is only valid when using a base position entered at the rover, the user must first set **\$PASHS,CPD,UBP,O** before entering **\$PASHS,CPD,ANT**.

Table 6.151. CPD,ANT Parameter Table

Parameter	Description	Range	Units
f1	Antenna height (measured from the point to the antenna edge). (Survey mark to edge of antenna)	0 - 64.000	meter
f2	Antenna radius (from antenna edge to antenna phase center)	0-9.9999	meter
f3	Vertical offset (phase center to ground plane)	0 - 99.9999	meter
m4	Horizontal azimuth in degrees and decimal minutes (dddmm.mm). Measured from survey mark to antenna phase center with respect to WGS84 north.	0 - 35959.59	degree/ decimal minutes
f5	Horizontal distance (distance from survey mark to a point directly below the antenna phase center).	0 - 999.999	meter

Example: Set antenna parameters of base station:

\$PASHS,CPD,ANT,6.4,0.13,0.02,3.5,1.0 <Enter>

\$PASHQ,CPD,ANT,c

Query antenna parameters where c is the optional output port:

Example: Query antenna parameters to present port:

\$PASHQ,CPD,ANT <Enter>

\$PASHR,CPD,ANT

The return message is in the form shown below and defined in Table 6.152.

\$PASHR,CPD,ANT,f1,f2,f3,m4,f5*cc <Enter>

Table 6.152. CPD,ANT Message Structure

Field	Description	Range	Units
f1	Antenna height	0 - 64.000	meter
f2	Antenna radius	0 - 9.9999	meter
f3	Vertical offset	0 - 99.9999	meter
m4	Horizontal azimuth (dddmm.mm)	0 - 35959.99	degree/decimal minutes
f5	Horizontal distance	0 - 999.9999	meter
cc	checksum		

CMR: CMR Received Mode

\$PASHS,CPD,CMR,ON/OFF

This command enables/disables detection of CMR messages. Default is ON.

Example: Enable CMR messages:

\$PASHS,CPD,CMR,ON<Enter>

\$PASHQ,CPD,CMR,[c]

Query status of CMR received mode. Internal use only.

DLK: Data Link Status

\$PASHQ,CPD,DLK,c

This command queries the data link status message, where c is the optional output port. If the port is not specified, the message is output to the port from which this command was received

Example: Query the data link status message to port A:

\$PASHQ,CPD,DLK,A <Enter>

\$PASHR,CPD,DLK

This response message is different for base and rover receiver.

The response message is in the form:

\$PASHR,CPD,DLK,s1,d2,d3,n(d4c5),s6,s7,d8,d9,d10,c11*cc <Enter>

n = number of satellites

Table 6.153. CPD,DLK Message Structure

Field	Description	Range	Unit
s1	receiver CPD mode	'BAS', 'ROV', 'RBB', 'RBR', 'OFF'	
The remainder of the message is only available when receiver is not in 'OFF' mode			
d2	BPS message warning flag	bit4 - displays "1" if the receiver has not tracked the L2 observables bit3 - displays "1" if the entered position and computed position differ by more than 500 meters in any direction bit2 - displays "1" if the base station has not computed position using the raw pseudo-ranges bit1 - displays "1" if base station antenna parameters are all zeros bit0 - displays "1" if the base station coordinates are not entered	
d3	Number of satellites in current DBEN message	0 - 12	
d4c5	SVPRN number and warnings. SV PRN Warning field description: + - no warnings C - warning in L1 measurements P - warning in L2 measurements - - warning in both measurements	1-32 '+' 'C' 'P' '-'	
s6	Message header (sender/designator identifications)	PASH = DBEN CMR2 = CMR	
The following message is only available if the receiver is in ROV or RVP base mode			
s7	Message masking (sender/designator)	PASH = DBEN CMR2 = CMR 1819 = RTCM 18/19 2012 = RTCM 20/21	
d8	BPS message age (or RTCM type 3/22)		sec
d9	Percentage of good DBEN message reception (or RTCM type 18/19 or 20/21)		

Table 6.153. CPD,DLK Message Structure (continued)

Field	Description	Range	Unit
d10	DBEN message age		ms
c11	Communication port status: '+' data is in the communication port '-' no data in the communication port	'+', '-'	
*cc	Checksum		

The following examples will illustrate the difference between the \$PASHR,DLK response message from a Rover station receiver and from a base station receiver (Table 6.154, Table 6.155).

From the Rover station:

```
$PASHR,CPD,DLK,ROV,02,05,02+,03C,10+,18+,19P,PASH,
PASH,024,100.00,0405,+*44 <Enter>
```

Table 6.154. CPD,DLK Response Message Example - Rover Station

Field	Significance
ROV	Receiver CPD mode = rover
02	BPS warning flag - base station antenna parameters are all zeros
05	Number of SVs in current DBEN message = 5
02+	SV 02, warning = none
03C	SV 03, warning = L1 measurement warning
10+	SV 10, warning = none
18+	SV 18, warning = none
19P	SV 19, warning - L2 measurement warning
PASH	DBEN message header
PASH	DBEN message masking
024	BPS message age
100.00	Percentage of good DBEN message reception
0405	DBEN message age
+	Data is in the communication port
*44	checksum

From the Base station:

```
$PASHR,CPD,DLK,BAS,02,05,02+,03+,10+,18+,19P,,PASH*12 <Enter>
```

Table 6.155. CPD,DLK Response Message Example - Base Station

Field	Significance
BAS	Receiver CPD mode = base
02	BPS warning flag - base station antenna parameters are all zeros
05	Number of SVs in current DBEN message = 5
02+	SV 02, warning = none

Table 6.155. CPD,DLK Response Message Example - Base Station

Field	Significance
03C	SV 03, warning - L1 measurement warning
10+	SV 10, warning = none
18+	SV 18, warning = none
19P	SV 19, warning = L2 measurement warning
PASHS	DBEN message header
*12	checksum

DYN: Rover Dynamics

\$PASHS,CPD,DYN,d1

This command sets rover's dynamic information, where d1 is a code number that best represents the motion of the rover receiver. This command is relevant only for ROVER or RVP BASE receiver. The default is 2 (walking dynamics).

Example: Set rover dynamics to aircraft dynamics:

```
$PASHS,CPD,DYN,4, <Enter>
```

Table 6.156. CPD,DYN Parameter Table

Parameter	Description
d1	Dynamic. One of the following values: 0 -- Static (antenna on tripod) 1 -- Quasi-static (antenna on manual pole) 2 -- Walking (default) 3 -- Automobile 4 -- Aircraft 5 -- Ship

ENT: Use Current Position

\$PASHS,CPD,ENT

This command sets the current raw position as the BASE position.

Example: Use current raw position as the base position:

```
$PASHS,CPD,ENT <Enter>
```

EOT: End of Transmission

\$PASHS,CPD,EOT,s

Selects the type of EOT character(s) to be sent in the DBEN message, where s is a string indicating the characters to be sent, as defined in Table 6.157. Used only in the base receiver.

Table 6.157. CPD,EOT Parameter Table

Parameter	Range	Characters to be sent
s	'NONE' 'CR' 'CRLF'	nothing 0x0D 0x0D 0x0A (default)

Example: Use CR as EOT characters:

\$PASHS,CPD,EOT,CR <Enter>

FST: Fast CPD Mode

\$PASHS,CPD,FST,s

Enables/disables fast CPD mode, where s is either ON or OFF. If this mode is set to ON, the rover receiver provides a fast CPD position solution. This command is relevant for ROVER receiver only. The default is ON.

Example: Turn fast CPD OFF:

\$PASHS,CPD,FST,OFF <Enter>

INF: CPD Information

\$PASHQ,CPD,INF,c

This command queries the INF message where c is the optional output port. This message contains base and rover satellite status information.

Example: Query the CPD satellite information message to the current port:

\$PASHQ,CPD,INF <Enter>

\$PASHR,CPD,INF

The response message is in the form:

\$PASHR,CPD,INF,s1,d2,n(d3,c4),d5,m(d6,c7),d8,d9,d10*cc <Enter>

n = number of SVs in the base

m = number of SVs in the rover

Table 6.158. INF Message Structure

Field	Description	Range	Units
s1	CPD mode	OFF, BAS, ROV, RBR, RBB	
d2	Number of Svs in base station. This determines how many fields to be followed.	0 - 12	
d3	SVPRN for the Svs in base receiver	1-32	
c4	Warning field description: + - no warnings C - warning in L1 measurements P - warning in L2 measurements -- warning in both measurements	'+' '-' 'C' 'P'	
... repeats for other SVs in base station			
d5	Number of Svs in the rover station. This determines the number of fields to follow.	0-12	

Table 6.158. INF Message Structure (continued)

Field	Description	Range	Units
d6	SVPRN for the Svs in the rover receiver	1-32	
c7	Warning field description: + - no warnings C - warning in L1 measurements P - warning in L2 measurements - - warning in both measurements	'+' '-' 'C' 'P'	
... repeats for other SVs in rover station			
d8	Last BPS message time (empty for RBB)		ms
d9	Last DBEN message time		ms
d10	BPS message warning (see \$PASHR,BPS for coding scheme)		
*cc	Checksum		

MAX: Max Age for CPD Correction

\$PASHS,CPD,MAX,d

Set the maximum age in seconds of CPD differential correction above which it will not be used in the position solution, where d is any number between 1 and 30. Default is 30. The max age is used only in REMOTE / ROVER mode. The max setting can be checked through the \$PASHQ,CPD command.

Example: Set maximum age to 10 seconds:

```
$PASHS,CPD,MAX,10 <Enter>
```

MOD: CPD Mode

\$PASHS,CPD,MOD,s

This command enables/disables CPD mode, where s is a string that defines the mode.

Example: Set receiver to Base CPD mode:

```
$PASHS,CPD,MOD,BAS <Enter>
```

Table 6.159. CPD,MOD Parameter Table

Parameter	Character String	Description
s	BAS ROV RBR RBB OFF	CPD BASE mode CPD ROVER mode RVP (reverse vector processing) ROVER mode: outputs DBEN message only RVP BASE mode: it computes the RVP ROVER's position Disable CPD mode

\$PASHQ,CPD,MOD,c

Queries the current CPD setting, where c is the optional output port. This message contains information about current CPD mode. If the port is not specified, the message is output to the port from which this command was received.

Example: Query the receiver for CPD mode information:

```
$PASHQ,CPD,MOD <Enter>
```

\$PASHR,CPD,MOD

The response is in the form:

\$PASHR,CPD,MOD,s1,s2,c3,f4,d5,d6,s7,s8,f9,s10,d11,s12,f13*cc <Enter>

Table 6.160. CPD,MOD Message Structure

Parameter	Description	Range
s1	Mode	'BAS','ROV','RBB','RBR','OFF'
s2	Fast CPD mode	'OFF','FST'
c3	Port	A/B/C/D
f4	CPD update period	1.0 - 5.0 (second)
d5	Rover's dynamics (see \$PASHS,CPD,DYN)	0 - 5
d6	Multipath information (see \$PASHS,CPD,MTP)	0 - 4
s7	DBEN type	'RCA','RP1','RP2','RPC'
s8	DBEN smooth on /off	'SMS', 'UNS'
f9	DBEN transmission period	0.0 - 999.0
s10	Which base position to use (entered/received)	'ETD','XIT'
d11	BPS transmission period or broadcast interval	0,10,30,100,300
s12	Which solution to output	'CPD', 'RAW', 'RBP'
f13	Ambiguity fixing confidence level	99.0, 95.0, 99.0, 99.9

MTP: Multipath

\$PASHS,CPD,MTP,d1

This command sets the multipath parameter, where d1 is a code that describes the multi-path environment. This command is relevant for ROVER mode or RVP BASE mode only. Default is medium (2).

Example: Set multipath parameter to high:

\$PASHS,CPD,MTP,3 <Enter>

Table 6.161. MTP Parameter Table

Parameter	Description
d1	Multipath. One of the following values: 0 - no multipath (zero baseline) 1 - Low (open field) 2 - Medium (default) 3 - high (water surface, buildings) 4 - Severe (forest, urban canyon)

OBN: Vector Solution Information

\$PASHQ,OBN

This command queries the OBN message. The OBN message contains information about the vector solution accumulated during the static site occupation. To output an OBN message, the following receiver parameters must be set:

- The receiver must be in CPD Rover mode (\$PASHS,CPD,MOD,ROV)
- The CPD dynamics must be set to static (\$PASHS,CPD,DYN,0)
- The 4-character site field must be set to a valid site name (\$PASHS,SIT)

Example: Query OBN message, send response to current port:

```
$PASHQ,OBN <Enter>
```

\$PASHR,OBN

The response message is in binary as shown below and defined in Table 6.162:

```
$PASHR,OBN,<OBEN structure> <Enter>
```

Table 6.162. OBEN Message Structure (Binary Format)

Type		Description	Units
int		Number of channels in receiver	
Base site information	int	site ID	4 character
	float	slant height	meters
	float	antenna radius	meters
	float	vertical offset	meters
	float	north offset	meters
	float	east offset	meters
	float	temperature	degrees C
	float	humidity	percent
	float	air pressure	millibars
	double	WGS 84 X component of position	meters
	double	WGS 84 Y component of position	meters
	double	WGS 84 Z component of position	meters

Table 6.162. OBEN Message Structure (Binary Format) (continued)

	Type	Description	Units
Baseline information	int	Number of epochs available	
	int	Number of epochs used in solution	
	int	Number of satellites used for solution	
	int	Reference SV PRN number	
	int	PRNs of used satellites	
	long	L1 ambiguity	0.01 cycles
	int	Number of epochs for each satellite	
	float	Standard deviation of L1 ambiguity	cycles
	long	L2 ambiguity	0.01 cycles
	float	Standard deviation of L2 ambiguity	cycles
	float	Standard deviation of vector x component	meters
	float	Standard deviation of vector y component	meters
	float	Standard deviation of vector Z component	meters
	float	Cross correlation XY	meters
	float	Cross correlation XZ	meters
	float	Cross correlation YZ	meters
	double	Baseline component delta X	meters
	double	Baseline component delta Y	meters
	double	Baseline component delta Z	meters
	float	Lowest contrast ratio for fixing ambiguities	
	int	Number of fixed ambiguities	
	float	RMS residual	meters
float	chi-squared		

Table 6.162. OBEN Message Structure (Binary Format) (continued)

Type		Description	Units
Time Tag	int	Week number of static site occupation beginning	
	int	Week number of last epoch	
	long	Week millisecond of static site occupation beginning	milliseconds
	long	Week millisecond of last epoch	milliseconds
	checksum		
Total Bytes	446		

OUT: Solution Output

\$PASHS,CPD,OUT,d1

This command selects which position solution to output to the serial port and/or the data card. This command is relevant for ROVER mode or RVP BASE mode. The default is 1.

Table 6.163. CPD,OUT Parameter Table

Parameter	Description
d1	<p>solution output selection: 0 - raw pseudo range solution (autonomous) 1 - CPD solution if available. (default)</p> <p>Note 1: CPD solution can only be stored on the PC card in a C-file (data mode 2 or 4 See "\$PASHS,RNG,d" on page 127).</p> <p>Note 2 : When the receiver is set to ROVER mode and the CPD solution is not available, no solution will be output to the serial port. However, the raw pseudo-range solution will be stored in the data card.</p> <p>Note 3: If receiver is in RVP BASE mode, the CPD solution will be output via serial ports but will not be stored into receiver's data card (B and C files) because this solution is the rover's position.</p> <p>2 - Same as 1, but in RVP Base Mode, the solution WILL BE stored into receiver's C-file on the data card.</p>

Example: Set CPD output to raw position output:

```
$PASHS,CPD,OUT,0 <Enter>
```

PEB: Base Broadcast Interval

\$PASHS,CPD,PEB,d1

This command specifies the broadcasting interval for the BPS message, where d1 is the interval in seconds. The BPS message contains base station's ground mark coordinates (if relevant) and antenna offset from reference point. When using CMR format, this command controls the broadcast interval of the reference station coordinates and offset to the antenna phase center (CMR type 1 message). This command is relevant for BASE mode or RVP ROVER mode.

Table 6.164. CPD,PEB Parameter Table

Parameter	Description	Units	Default
d1	Base coordinates broadcast interval. Only the following values are valid: 0, 10, 30, 60, 120, 300 (0 for no transmission).	second	30 seconds

Example: Set BPS broadcast interval to 10 seconds:

```
$PASHS,CPD,PEB,10 <Enter>
```

PED: DBEN/CMR Transmission Period

\$PASHS,CPD,PED,d1

This command sets the period of the DBEN or CMR message transmission, where d1 is the transmission period in seconds. This command is relevant for BASE mode or RVP ROVER mode.

Table 6.165. CPD,PED Parameter Table

Parameter	Description	Range	Unit	Default
d1	DBEN/CMR transmission period	0.2, 0.3, 0.4, 0.5, 0.7, 0.8, and 1.0 to 999 (0 = no transmission)	seconds	1 second

Example: Set DBEN transmission period to 3 seconds:

```
$PASHS,CPD,PED,3 <Enter>
```

PER: CPD Update Interval

\$PASHS,CPD,PER,d1

This command selects the CPD Kalman filter update interval, where d1 is the update interval in seconds. This command is relevant for ROVER mode or RVP BASE mode, and when fast CPD is set to OFF.

Table 6.166. CPD,PER Parameter Table

Parameter	Description	Range	Unit	Default
d1	Kalman filter update period	0.2, 0.3, 0.4, 0.5, 0.7, 0.8, 0.9, 1, 2, 3, 4, 5	sec	1 second

Example: Set CPD update interval to 3 seconds:

```
$PASHS,CPD,PER,3 <Enter>
```

POS: Set Base Position

\$PASHS,CPD,POS,m1,c2,m3,c4,f5

This command sets the base point position from the rover receiver.

Table 6.167. CPD,POS Parameter Table

Parameter	Description	Range
m1	Latitude of base position in degrees and decimal minutes (ddmm.mmmmmmm).	0-8959.9999999
c2	Direction of latitude N = North, S = South	'S', 'N'
m3	Longitude of base position in degrees and decimal minutes (dddmm.mmmmmmm)	0-17959.9999999
c4	Direction of longitude E = East, W = West	'E', 'W'
f5	Reference point altitude (always have + or - sign) (in meters)	±9999.9999



This requires the receiver configured to use the entered base position (by issuing command **\$PASHS,UBP,0**)

Example: Set base position from the rover receiver:

```
$PASHS,CPD,POS,3722.2432438,N,12350.5438423,W,+34.5672 <Enter>
```

\$PASHQ,CPD,POS,c

This command queries the base position from the rover, where c is the optional serial port. If the port is not specified, the message is output to port from which this command was received.

Example: Query base position set at the rover receiver:

```
$PASHQ,CPD,POS <Enter>
```

\$PASHR,CPD,POS

The response message is in the form:

```
$PASHR,CPD,POS,m1,c2,m3,c4,f5 <Enter>
```

The description of these parameters can be found in Table 6.167.

PRO: Select RTK Format

\$PASHS,CPD,PRO,s

This command sets the output format of the CPD message transmitted from the base receiver, where s is a 3-character string as defined in Table 6.168. The parameter can be set to either DBN (Ashtech proprietary format) or CMR

(compact measurement record). This command is relevant only for the base receiver, and is not relevant when outputting RTCM 18/19 or 20/21 messages. The default is DBN. .

Table 6.168. CPD,PRO Parameter

Parameter	Description
s	3-character string DBN = DBEN output format CMR = CMR (compact measurement record) output format

PRT: Port Output Setting

\$PASHS,CPD,PRT,c

This command sets the port to output DBEN and BPS messages, where c is the desired port. This is only relevant to BASE or RVP ROVER mode. Default port is B.

Example: Output DBEN and BPS messages to port C:

```
$PASHS,CPD,PRT,C <Enter>
```

RST: Reset CPD

\$PASHS,CPD,RST

Reset the PNAV processing (Kalman filter reset). This command is relevant for ROVER mode or RVP BASE mode only.

Example: Reset the PNAV Kalman Filter:

```
$PASHS,CPD,RST <Enter>
```

STS: CPD Solution Status

\$PASHQ,CPD,STS,c

This command queries the CPD Solution Status message, where c is the optional output port. This message contains information about the current CPD/PNAV Processing status.

Example: Query solution status to port D:

```
$PASHQ,CPD,STS,D <Enter>
```

\$PASHR,CPD,STS

The response message is in the form:

\$PASHR,CPD,STS,f1,f2*cc <Enter>

Table 6.169. CPD,STS Message Structure

Field	Description	Range	Units
f1	RMS phase residual	0.00 - 0.100	meter
f2	Ambiguity Fixing Contrast Ratio	0.00 - 99999.99	
*cc	Checksum		

UBP: Use Base Position

\$PASHS,CPD,UBP,d1

This command selects the base position to use in ROVER mode, where d1 indicates the desired base position. This command is relevant for ROVER mode only. Default is 1.

Table 6.170. CPD,UBP Parameter Table

Parameter	Description	Range	Default
d1	Base position to use: 0 = Use entered base position 1 = Use transmitted base position	0,1	1

Example: Use entered base station position:

\$PASHS,CPD,UBP,0 <Enter>

UCT Commands

The User Coordinate Transformation (UCT) library, Table 6.171, includes user-defined transformation data (e.g., datums, grid systems, map projection parameters, etc.) and transformation functions. You can define and store 1 set of transformation parameters, and do transformation based on these parameters.

The UCT commands include:

- Transformation Parameters
- Transformation Selection
- Coordinate Output

Table 6.171. UCT Commands

Command	Description	Page
TRANSFORMATION PARAMETERS SETTING		
\$PASHS,UDD	Set datum-to-datum transformation parameters	281
\$PASHQ,UDD	Query 7 parameters of datum-to-datum transformation	283
\$PASHS,UDG	Set datum-to-grid projection parameters	283
\$PASHQ,UDG	Query parameters of datum-to-grid projection (variable parameters)	287
TRANSFORMATION SELECTION		
\$PASHS,DTM	Select datum to use (preset or user-defined)	279
\$PASHQ,DTM	Query datum used	279
\$PASHS,GRD	Select grid (map projection) mode	280
\$PASHQ,GRD	Query grid (map projection) mode	280
\$PASHS,HGT	Select height model	280
\$PASHQ,HGT	Query height model	281
COORDINATES OUTPUT		
\$PASHS,NME,GGA	Enable/disable geographic position output	202
\$PASHS,NME,GLL\$P	Enable/disable latitude/longitude response message	206
\$PASHS,NME,POS	Enable/disable NMEA position response message	223
\$PASHS,NME,GXP	Enable/disable the horizontal position message	215
\$PASHS,NME,GDC	Enable/disable user-defined grid coordinates output	198
\$PASHQ,GDC	Query user-defined grid coordinates	198
\$PASHS,NME,UTM	Enable/disable UTM grid coordinates output	234
\$PASHQ,UTM	Query UTM grid coordinates	234

DTM: Datum Selection

\$PASHS,DTM,s

Select the geodetic datum used for position computation and measurements, where *s* is a 3-character string that defines a pre-defined datum or UDD (User-Defined Datum). Parameters for user-defined datum are entered with the **\$PASHS,UDD** command (page 281). W84 is the default. For the list of available predefined datums, see Appendix A, **Reference Datums & Ellipsoids**.

Example: Select user-defined datum for position computation:

```
$PASHS,DTM,UDD <Enter>
```



This does not affect the position output in the B-file or in the PBN message which are ECEF and always with respect to WGS-84.

\$PASHQ,DTM,c

Query datum setting where *c* is the optional output port.

Example: Query the DTM status to port C:

```
$PASHQ,DTM,C <Enter>
```

\$PASHR,DTM

The response message is in the form:

```
$PASHR,DTM,s*cc <Enter>
```

where *s* is the 3 character string that denotes the current datum setting. For the list of available datum, see Appendix A, **Reference Datums & Ellipsoids**.



Transformation charts, including DMA, list the datum transformation parameters as “from” local → “to” WGS-84. This format is used for the UDD interface and the parameter signs are automatically inverted before the transformation is executed.

FUM: Fix UTM Zone

\$PASHS,FUM,c

This command will enable/disable the fixing of the UTM zone, where *c* is either Y (enable) or N (disable). The default is N. This command is mostly used when the user is near a UTM boundary and outputting position in UTM coordinates and does not want the UTM coordinates to suddenly shift from one zone to another if the boundary is crossed. Use the **\$PASHS,FZM** command to set the zone that will be fixed.

Example: Select the UTM zone to be fixed:

```
$PASHS,FUM,Y <Enter>
```

FZN: Set UTM Zone to Fix

\$PASHS,FZN,d

This command will set the UTM zone that will be held fixed, where d is the UTM zone and ranges from 1 to 60. this command is mostly used when the user is near a UTM boundary and outputting position in UTM coordinates and does not want the UTM coordinates to suddenly shift from one zone to another if the boundary is crossed. This command must be used with \$PASHS,FUM.

Example: Select UTM zone 10 to be fixed:

```
$PASHS,FZN,10 <Enter>
```

GRD: Datum-to-Grid Transformation Selection (Map Projection)

\$PASHS,GRD,s

Enable/Disable the usage of the datum-to-grid transformation where s is a 3 character string:

NON: (default: none) disable datum-to-grid transformation

UDG: enable datum-to-grid transformation

Parameters for user-defined datum are entered with the \$PASHS,UDG command (on page 283). Grid coordinates are output in the "\$PASHR,GDC" on page 198.

Example: Enable user-defined datum-to-grid transformation:

```
$PASHS,GRD,UDG <Enter>
```

\$PASHQ,GRD,c

Associated query command where c is the optional output port.

Example: Query the GRD status to port C:

```
$PASHQ,GRD,C <Enter>
```

\$PASHR,GRD

The response message is in the form:

```
$PASHR,GRD,s*cc <Enter>
```

where s is the 3-character string that denotes the current datum-to-grid setting (NON or UDG)

HGT: Height Model Selection

\$PASHS,HGT,s

Select the height used in the position output messages, where s is a 3- character string:

ELG: (default) output ellipsoidal heights in position messages.

GEO: output orthometric heights in position messages using worldwide

geoidal model.



This does not affect the position output in the B-file or in the PBN message which are ECEF and always with respect to WGS84.



To remain NMEA standard, the GGA message will always output geoidal height whatever the selection is. This selection affects the height value in other position messages such as POS, UTM and GDC.

Example: Select geoidal height in position output:

```
$PASHS,HGT,GEO <Enter>
```

\$PASHQ,HGT,c

Query height model selection where c is the optional output port.

Example: Query the HGT status to port C:

```
$PASHQ,HGT,C <Enter>
```

\$PASHR,HGT

The response message is in the form:

```
$PASHR,HGT,s*cc <Enter>
```

where s is the 3-character string that denotes the current height setting (ELG or GEO).

UDD: User-Defined Datum

\$PASHS,UDD,d1,f2,f3,f4,f5,f6,f7,f8,f9,f10

Sets the user-defined datum parameters in the receiver memory.

Table 6.172. UDD Message Structure

Parameter	Description	Range	Units	Default
d1	Geodetic datum. Always 0 for WGS 84.	0	n/a	0
f2	Semi-major axis	6300000.000-6400000.000	meters	6378137.000
f3	Inverse Flattening in meters.	290.0000000-301.0000000	meters	298.257223563
f4	Translation in x direction*	±1000.000	meters	0.00
f5	Translation in y direction*	±1000.000	meters	0.00
f6	Translation in z direction*	±1000.000	meters	0.00

Table 6.172. UDD Message Structure (continued)

Parameter	Description	Range	Units	Default
f7	Rotation about x axis* + rotation is counter clockwise, and - rotation is clockwise rotation, about the origin.	±10.000	sec	0.000
f8	Rotation about y axis*	±10.000	sec	0.000
f9	Rotation about z axis*	±10.000	sec	0.000
f10	Delta scale factor (scale factor = 1 + delta scale factor)	±25.000	PPM	0.0000
* Translations, rotations, and scale factors are entered as going from local datum to WGS84				

Example: Set datum parameters:

```
$PASHS,UDD,0,637 8240, 297.323, 34.23, 121.4, 18.9, 0, 0, 0, 0 <Enter>
```

\$PASHQ,UDD,c

Query the user datum parameters where c is the optional output port and is not required to direct the response message to the current communication port.

Example: Query datum parameters to port C:

```
$PASHQ,UDD,C <Enter>
```

\$PASHR,UDD

The response is in the form:

```
$PASHR,UDD,d1,f2,f3,f4,f5,f6.f7,f8,f9,f10*cc <Enter>
```

where the parameters are as defined in Table 6.172.

UDG: User-Defined Datum-to-Grid Transformation

\$PASHS,UDG,s1,d2,f3,f4,f5,f6,f7,f8,f9,f10,f11,f12,f13

Sets the user-defined datum-to-grid transformation parameters in the receiver memory. The number of parameters depends on the map projection type selected and must be indicated by the user as parameter d2.

Table 6.173 through Table 6.177 define the parameters projection type.

Table 6.173. UDG Structure for Equatorial Mercator

Field	Description	Range	Units
s1	Map projection type	EMER	n/a
d2	Number of parameters for the selected projection	3	n/a
f3	Longitude for the central meridian	±1800000.0000	ddmmss.ssss
f4	False northing	±10,000,000	meters
f5	False easting	±10,000,000	meters

Table 6.174. UDG Structure for Transverse Mercator

Field	Description	Range	Units
s1	Map projection type	TM83	n/a
d2	Number of parameters for the selected projection	5	n/a
f3	Longitude for central meridian	±1800000.0000	ddmmss.ssss
f4	Scale factor at central meridian	0.5-1.5	n/a

Table 6.174. UDG Structure for Transverse Mercator (continued)

Field	Description	Range	Units
f5	Latitude of the grid origin of the projection	±900000.0000	ddmmss.ssss
f6	False easting	±10,000,000	meters
f7	False northing	±10,000,000	meters

Table 6.175. UDG Structure for Oblique Mercator

Field	Description	Range	Units
s1	Map projection type	OM83	n/a
d2	Number of parameters for selected projection	6	n/a
f3	Azimuth of the skew axis	±1800000.0000	ddmmss.ssss
f4	Scale factor at center of projection	0.5-1.5	n/a
f5	Longitude of the grid origin of projection	±1800000.0000	ddmmss.ssss
f6	Latitude of the grid origin of projection	±900000.0000	ddmmss.ssss
f7	False easting	±10,000,000	meters
f8	False northing	±10,000,000	meters

Table 6.176. UDG Structure for Stereographic (Polar and Oblique)

Field	Description	Range	Units
s1	Map projection type	STER	n/a
d2	Number of parameters for selected projection	5	n/a
f3	Latitude of the grid origin of projection	±900000.0000	ddmmss.ssss
f4	Longitude of the grid origin of projection	±1800000.0000	ddmmss.ssss
f5	Scale factor at center of projection	0.5-1.5	n/a
f6	False easting	±10,000,000	meters
f7	False northing	±10,000,000	meters

Table 6.177. UDG Structure for Lambert CC SPC83 (2 std parallels)

Field	Description	Range	Units
s1	Map projection type	LC83	n/a
d2	Number of parameters for selected projection	6	n/a

Table 6.177. UDG Structure for Lambert CC SPC83 (2 std parallels) (continued)

Field	Description	Range	Units
f3	Latitude of southern standard parallel	±900000.0000	ddmmss.ssss
f4	Latitude of northern standard parallel	±900000.0000	ddmmss.ssss
f5	Longitude of the grid origin of the projection	±1800000.0000	ddmmss.ssss
f6	Latitude of the grid origin of the projection	±900000.0000	ddmmss.sss
f7	False easting	±10,000,000	meters
f8	False northing	±10,000,000	meters

The following SPC27 map projections must be used in conjunction with the Clarke 1866 ellipsoid ($a = 6378206.4$ m and $1/f = 294.978698200$) and the following datum ($T_x = -8.0$, $T_y = 160.0$, $T_z = 176.0$, rotation and scale = 0) which is included in the preset datum list as NAC.

Values are derived from tables which can be obtained from various sources, including NGS Publication 62-4 (1986 Reprint) which also includes discussion and definitions of applied formulas and parameters.

Table 6.178. UDG Structure for Lambert Conic Conformal for SPC27

Description	Range Name
Map projection type.	LC27
Number of parameters for selected projection	11
False easting or x coordinate of central meridian	L1
Longitude of central meridian	L2
Map radius of central parallel (Φ_0)	L3
Map radius of lowest parallel of projection table plus y value on central meridian at this parallel ($y = 0$ in most cases)	L4
Scale (m) of projection along central parallel (Φ_0)	L5
Sine of latitude of central parallel (Φ_0) computed from basic equations for Lambert projection with 2 standard parallel.	L6
Degree, minute portion of the rectifying latitude ω_0 for Φ_0 , latitude of origin	L7
Remainder of ω_0	L8
$1/6 * R_0 * N_0 * 10^6$	L9
$\tan \Phi_0 / 24 * (R_0 * N_0)^{3/2} * 10^{24}$	L10
$[(5 + 3 * \tan^2 \Phi_0) / 120 * R_0 * N_0^3] * 10^{32}$	L11
Number of parameters for selected projection	11

$f_9 : w = F - [1052.893882 - (4.483344 - 0.002352 * \cos^2 F) * \cos^2 F] * \sin F * \cos F$
 $f_{11}/f_{12}/f_{13} : R_0 = a * (1 - e^2) / (1 - e^2 * \sin^2 F_0)^{3/2} : \text{radius of curvature in meridian plane at } F_0$

$No = a / (1 - e^2 * \sin^2 Fo)^{1/2}$: radius of curvature in prime vertical at Fo

Table 6.179. UDG Structure for Transverse Mercator for SPC27

Description	Range/Name in Table
Map projection type	TM27
Number of parameters for selected projection	6
False Easting or x coordinate of central meridian	T1
Longitude of Central meridian	T2
Degree, minute portion of rectifying latitude ω_0 for Φ_0 , latitude of origin	T3
Remainder of ω_0	T4
Scale along central meridian	T5
$(1/6 * Rm * Nm * T5^2) * 10^{15}$	T6

Rm = radius of curvature in meridian plane

Nm = radius of curvature in prime vertical

Both calculated for the mean latitude of the area in the zone.

Table 6.180. UDG Structure for Transverse Mercator SPC27 Alaska Zone 2-9

Parameter	Description	Range/Name
s1	Map projection type.	TMA7
d2	Number of parameters for selected projection	2
f3	False easting or x coordinate of central meridian	C
f4	Longitude of central meridian	CM

Example: Set datum-to-grid transformation for Lambert Conformal CA-zone 4:

```
$PASHS,UDG,LC83,6,360000.0,371500.0,
-1190000.0,352000.0,2000000,500000 <Enter>
```

Example: Set datum-to-grid transformation parameters:

```
$PASHS,UDG,LC83,637 8240,297.323,121.4,18.9,0,0,0,1.5 <Enter>
```

\$PASHQ,UDG,c

The associated query command, where c is the optional output port and is not required to direct the response message to the current communication port.

Example: Query datum-to-grid transformation parameters to port C:

```
$PASHQ,UDG,C <Enter>
```

\$PASHR,UDG

The response is in the format:

\$PASHR,UDG,s1,d2,f3,f4,f5,f6,f7,f8,f9,f10,f11,f12,f13*cc <Enter>

where the fields (and the number of them) are defined in the above tables and depend upon the selected map projection.

A

Reference Datums & Ellipsoids

The following tables list geodetic datums and reference ellipsoid parameters.



The translation values are in the format - From local to WGS84.

Table A.1. Available Geodetic Datums

Datum ID	Reference Ellipsoid	Offset in meters (dX,dY,dZ)	Datum Description
ARF	Clarke 1880	-143, -90, -294	ARC 1950 (Botswana, Lesotho, Malawi, Swaziland, Zaire, Zambia ,Zimbabwe)
ARS	Clarke 1880	-160, -8, -300	ARC 1960 (Kenya, Tanzania)
AUA	Australian National	-133, -48, 148	ANS66 Australian Geodetic Datum 1966 (Australia, Tasmania Island)
AUG	Australian National	-134, -48, 149	ANS84 Australian Geodetic Datum 1984 (Australia, Tasmania Island)
BOO	International 1924	307, 304, -318	Bogota, Bogota Observatory (Columbia)
CAI	International 1924	-148, 136, 90	Campo, S. American Campo Inchauspe (Argentina)
CAP	Clarke 1880	-136, -108, -292	Cape (South Africa)
CGE	Clarke 1880	-263, 6, 431	Carthage (Tunisia)
CHI	International 1924	175, -38, 113	Chatham 1971 (Chatham,New Zeland)
CHU	International 1924	-134, 229, -29	S. American Chua Astro (Paraguay)
COA	International 1924	-206, 172, -6	S. American Corrego Alegre (Brazil)
EUA	International 1924	-87, -96, -120	European 1950 (Western Europe: Austria, Denmark, France, F.R. of Germany, Netherlands, Switzerland)

Table A.1. Available Geodetic Datums (continued)

Datum ID	Reference Ellipsoid	Offset in meters (dX,dY,dZ)	Datum Description
EUE	International 1924	-104, -101, -140	European 1950 (Cyprus)
EUF	International 1924	-130, -117, -151	European 1950 (Egypt)
EUH	International 1924	-117, -132, -164	European 1950 (Iran)
EUJ	International 1924	-97, -88, -135	European 1950 (Sicily)
EUS	International 1924	-86, -98, -119	European 1979 (Austria, Finland, Netherlands, Norway, Spain, Sweden, Switzerland)
FAH	Clarke 1880	-346, -1, 224	Oman
GAA	International 1924	-133, -321, 50	Gandajika Base (Rep. of Maldives)
GEO	International 1924	84, -22, 209	Geodetic Datum 1949 (New Zealand)
HJO	International 1924	-73, 46, -86	Hjorsej 195 (Iceland)
INA	Everest	214, 836, 303	Indian 1 (Thailand, Vietnam)
INM	Everest	289, 734, 257	Indian 2 (India, Nepal, Bangladesh)
IRL	Modified Airy	506, -122, 611	Ireland 1965
KEA	Modified Everest	-11, 851, 5	Kertau 1948 (West Malaysia, Singapore)
LIB	Clarke 1880	-90, 40, 88	Liberia 1964
LUZ	Clarke 1866	-133, -77, -51	Luzon (Philippines excluding Mindanao Is.)
MAS	Bessel 1841	639, 405, 60	Massawa (Eritrea, Ethiopia)
MER	Clarke 1880	31, 146, 47	Merchich (Morocco)
MIN	Clarke 1880	-92, -93, 122	Minna (Nigeria)
NAC	Clarke 1866	-8, 160, 176	NAD27 N. American CONUS 1927 (North America)
NAD	Clarke 1866	-5, 135, 172	AK27 N. American Alaska 1927 (Alaska)
NAE	Clarke 1866	-10, 158, 187	CAN27 N. American Canada 1927 (Canada incl. Newfoundland Island)
NAH	Clarke 1880	-231, -196, 482	Nahrwan (Saudi Arabia)
NAN	Clarke 1866	-6, 127, 192	Central America (Belize, Costa Rica, El Salvador, Guatemala, Honduras, Nicaragua, Mexico)
NAR	GRS1980	0, 0, 0	GRS80 North American 1983
OEG	Helmert 1906	-130, 110, -13	Old Egyptian

Table A.1. Available Geodetic Datums (continued)

Datum ID	Reference Ellipsoid	Offset in meters (dX,dY,dZ)	Datum Description
OGB	Airy 1830	375, -111, 431	OSG Ordnance Survey of Great Britain 1936 (England, Isle of Man, Scotland, Shetland Islands, Wales)
OHA	Clarke 1866	61, -285, -181	OLDHW Old Hawaiian
PIT	International 1924	185, 165, 42	Pitcairn Astro 1967 (Pitcairn Island)
QAT	International 1924	-128, -283, 22	Qatar National (Qatar)
QUO	International 1924	164, 138, -189	Qornoq (South Greenland)
SAN	South American 1969	-57, 1, -41	SAMER69 S. American 1969 (Argentina, Bolivia, Brazil, Chile, Colombia, Ecuador, Guyana, Paraguay, Peru, Venezuela, Trinidad, Tobago)
SCK	Bessel 1841 Namibia	616, 97, -251	Schwarzeck (Namibia)
TIL	Everest	-689, 691, -46	Timbalai 1948 (Brunei, East Malaysia, Sarawak, Sabah)
TOY	Bessel 1841	-128, 481, 664	Tokyo (Japan, Korea, Okinawa)
UDD	User Defined	user defined	User defined
W72	WGS72	0, 0, +4.5	WGS72 World Geodetic System - 72
W84	WGS84	0, 0, 0	WGS84 World Geodetic System - 84
ZAN	International 1924	-265, 120, -358	Zanderij (Surinam)

Table A.2. Reference Ellipsoids

Ellipsoid	a (metres)	1/f	f
Airy 1830	6377563.396	299.3249647	0.00334085064038
Modified Airy	6377340.189	299.3249647	0.00334085064038
Australian National	6378160.0	298.25	0.00335289186924
Bessel 1841	6377397.155	299.1528128	0.00334277318217
Clarke 1866	6378206.4	294.9786982	0.00339007530409
Clarke 1880	6378249.145	293.465	0.00340756137870
Everest (India 1830)	6377276.345	300.8017	0.00332444929666
Everest (W.Malaysia and Singapore)	6377304.063	300.8017	0.00332444929666

Table A.2. Reference Ellipsoids (continued)

Ellipsoid	a (metres)	1/f	f
Geodetic Reference System 1980	6378137.0	298.257222101	0.00335281068118
Helmert 1906	6378200.0	298.30	0.00335232986926
International 1924	6378388.0	297.00	0.00336700336700
South American 1969	6378160.0	298.25	0.00335289186924
World Geodetic System 1972 (WGS-72)	6378135.0	298.26	0.00335277945417
World Geodetic System 1984 (WGS-84)	6378137.0	298.257223563	0.00335281066475



Global Product Support

If you have any problems or require further assistance, you can contact Technical Support by telephone, email, or Internet.

Please refer to the documentation before contacting Technical Support. Many common problems are identified within the documentation and suggestions are offered for solving them.

Ashtech Products Technical Support, Santa Clara CA USA

800 Number 800-229-2400

Direct Dial: (408) 615-2400

Switchboard: (408) 615-5100

FAX Line: (408) 615-5200

e-mail: support@thalesnavigation.com

Internet: <http://www.ashtech.com>

Nantes, France:

Direct Dial: 33 2 2809 3934

Switchboard: 33 2 2809 3800

e-mail: technical@thalesnavigation.com

Ashtech South America:

Tel: +56 2 234 56 43

FAX: +56 2 234 56 47

When contacting Technical Support, please have the following information:

Receiver serial number

Software version number

Software key serial number, if applicable

Firmware version number

A clear, concise description of the problem.

Solutions for Common Problems

- Check cables and power supplies. Many hardware problems are related to these simple problems.
- If the problem seems to be with your computer, re-boot it to clear RAM.
- If you are experiencing receiver problems, reset the receiver as documented in the set commands section of this manual. Reset clears receiver memory and resets operating parameters to factory defaults.
- Verify that the batteries are charged.
- Verify that the antenna view of the sky is unobstructed by trees, buildings, or other canopy.

Corporate Web Page

You can obtain data sheets, GPS information, application notes, and a variety of useful information from Ashtech's Internet web page at:

<http://www.ashtech.com>

Repair Centers

In addition to repair centers in California and England, authorized distributors in 27 countries can assist you with your service needs.

Thales Navigation

471 El Camino Real

Santa Clara, California 95050-4300 USA

Voice: (408) 615-3980 or (800) 229-2400

FAX: (408) 615-5200

e-mail: rmaprocessing@thalesnavigation.com

Ashtech Europe Ltd.

First Base, Beacontree Plaza

Gillete Way

Reading RG2 0BP

United Kingdom

Tel: 44 118 931 9600

FAX: 44 118 932 9601

Index

Symbols

\$GPALM,	185	\$PASHQ,CPD,STS,	276
\$GPGGA,	58, 202	\$PASHQ,CTS,	92
\$GPGLL,	206	\$PASHQ,DAL,	190
\$GPGRS,	207	\$PASHQ,DBN,	159
\$GPGSA,	209	\$PASHQ,DTM,	279
\$GPGSN,	211	\$PASHQ,EPB,	164
\$GPGSV,	214	\$PASHQ,FLS,	97
\$GPGXP,	216	\$PASHQ,GGA,	202
\$GPMSG,	217	\$PASHQ,GLL,	206
\$GPRMC,	227	\$PASHQ,GRS,	207
\$GPRRE,	229	\$PASHQ,GSA,	209
\$GPVTG,	237	\$PASHQ,GSN,	210
\$GPXDR,	238	\$PASHQ,GSV,	214
\$GPZDA,	240	\$PASHQ,GXP,	216
\$PASHQ,ALH,	88	\$PASHQ,INF,	102
\$PASHQ,ALH,c,	88	\$PASHQ,ION,	106
\$PASHQ,ALM,	185	\$PASHQ,LPS,	108, 109, 110
\$PASHQ,ANT,	90	\$PASHQ,MBN,	167
\$PASHQ,BEEP,	92	\$PASHQ,MDM,	110
\$PASHQ,CBN,	148	\$PASHQ,MET,	111
\$PASHQ,CPD,	256	\$PASHQ,MSG,	217
\$PASHQ,CPD,ANT,	260	\$PASHQ,OBN,	270
\$PASHQ,CPD,DLK,	58, 63, 260	\$PASHQ,PAR,	114
\$PASHQ,CPD,INF,	63, 266	\$PASHQ,PBN,	172
\$PASHQ,CPD,MOD,	63, 268	\$PASHQ,PHE,	117
\$PASHQ,CPD,OUT,	63	\$PASHQ,POW,	121
\$PASHQ,CPD,POS,	63, 275	\$PASHQ,PPS,	123
		\$PASHQ,PRT,	123
		\$PASHQ,RAW,	59, 63, 175

\$PASHQ,RID,	126, 127	\$PASHR,OBN,	270
\$PASHQ,RMC,	227	\$PASHR,PBN,	172
\$PASHQ,RRE,	229	\$PASHR,PHE,	118
\$PASHQ,RTC,	63, 243	\$PASHR,POS,	223
\$PASHQ,SAL,	177	\$PASHR,PPS,	123
\$PASHQ,SAT,	231	\$PASHR,PRT,	123
\$PASHQ,SES,	130	\$PASHR,RID,	126
\$PASHQ,SID,	133	\$PASHR,RPC,	160
\$PASHQ,SNV,	178	\$PASHR,RTR,	127
\$PASHQ,STA,	135	\$PASHR,SAT,	231
\$PASHQ,TMP,	138	\$PASHR,SNV,	179
\$PASHQ,TTT,	226	\$PASHR,TMP,	138
\$PASHQ,UDD,	283	\$PASHR,TTT,	226, 233
\$PASHQ,UDG,	287	\$PASHR,UDD,	283
\$PASHQ,UTM,	75, 234	\$PASHR,UDG,	288
\$PASHQ,VTG,	236	\$PASHR,UTM,	235
\$PASHQ,WARN,	63, 139	\$PASHR,WARN,	140
\$PASHQ,WKN,	144	\$PASHR,WKN,	144
\$PASHQ,XDR,c,	238	\$PASHS,ALT,	88
\$PASHQ,ZDA,	240	\$PASHS,ANA,	88
\$PASHR,ALH,	88	\$PASHS,ANH,f,	89
\$PASHR,ALM,	177	\$PASHS,ANR,	89
\$PASHR,ANT,	90	\$PASHS,ANR,OFF,	44
\$PASHR,BEEP,	92	\$PASHS,ANR,ON,	44
\$PASHR,BPS,	43	\$PASHS,ANT,	89, 90
\$PASHR,CBN,	148	\$PASHS,BEEP,	92
\$PASHR,CLM,	92	\$PASHS,CPD,AFP,	64, 259
\$PASHR,CPD,	58	\$PASHS,CPD,ANT,	44, 259
\$PASHR,CPD,ANT,	260	\$PASHS,CPD,DYN,	60, 64, 65, 265, 270
\$PASHR,CPD,DLK,	67, 261	\$PASHS,CPD,ENT,	265
\$PASHR,CPD,INF,	266	\$PASHS,CPD,EOT,	265
\$PASHR,CPD,MOD,	268	\$PASHS,CPD,FST,	64, 66, 266
\$PASHR,CPD,POS,	275	\$PASHS,CPD,FST,OFF,	60
\$PASHR,CPD,STS,	276	\$PASHS,CPD,MAX,	268
\$PASHR,CTS,	94	\$PASHS,CPD,MOD,	268
\$PASHR,DTM,	279	\$PASHS,CPD,MOD,ROV,	47, 48, 270
\$PASHR,EPB,	164	\$PASHS,CPD,MTP,	64, 66, 269
\$PASHR,FLS,	98	\$PASHS,CPD,OUT,	273
\$PASHR,INF,	102	\$PASHS,CPD,PEB,	273
\$PASHR,ION,	106	\$PASHS,CPD,PED,	64, 274
\$PASHR,LPS,	108	\$PASHS,CPD,PER,	64, 66, 274
\$PASHR,MDM,	110, 111	\$PASHS,CPD,POS,	44, 63, 67, 275
\$PASHR,MPC,	167	\$PASHS,CPD,PRT,	276

\$PASHS,CPD,RST,	64, 67, 276	\$PASHS,NME,TTT,	233
\$PASHS,CPD,UBP,	277	\$PASHS,NME,UTM,	75, 234
\$PASHS,CPD,UBS,	64, 67	\$PASHS,NME,VTG,	236
\$PASHS,CTS,	92	\$PASHS,NME,XDR,	238
\$PASHS,DOI,	9	\$PASHS,NME,ZDA,	239
\$PASHS,DRI,	9, 145	\$PASHS,OUT,	59, 172
\$PASHS,DSC,	95	\$PASHS,PDP,	117
\$PASHS,DSY,	95	\$PASHS,PEM,	15, 43, 54, 67, 117
\$PASHS,DTM,	96, 279	\$PASHS,PHE,	117, 121
\$PASHS,DTM,UDD,	73	\$PASHS,PJT,	118
\$PASHS,ELM,	15, 43, 67, 96	\$PASHS,PMD,	119
\$PASHS,FIL,	96	\$PASHS,POS,	119
\$PASHS,FIX,	97	\$PASHS,POW,	121
\$PASHS,GRD,UDG,	75	\$PASHS,PPO,	122
\$PASHS,HGT,	235	\$PASHS,PPS,	122
\$PASHS,INF,	100	\$PASHS,PWR,	125
\$PASHS,INI,	104	\$PASHS,RCI,	9, 59, 66, 125
\$PASHS,ION,	106	\$PASHS,REC,	125
\$PASHS,LTZ,	108, 138	\$PASHS,RNG,	127
\$PASHS,MDM,	109, 110	\$PASHS,RST,	46, 47, 48, 55, 127
\$PASHS,MET,CMD,	111	\$PASHS,RTC,AUT,	246
\$PASHS,MET,INIT,	112	\$PASHS,RTC,AUT,Y,	55
\$PASHS,MST,	112	\$PASHS,RTC,BAS,	246
\$PASHS,MSV,	113	\$PASHS,RTC,EOT,	246
\$PASHS,NME,	59	\$PASHS,RTC,INI,	246
\$PASHS,NME,ALL,	185	\$PASHS,RTC,MAX,	55, 247
\$PASHS,NME,ALM,	185	\$PASHS,RTC,MSG,	247
\$PASHS,NME,DAL,	190	\$PASHS,RTC,OFF,	249
\$PASHS,NME,GDC,	75	\$PASHS,RTC,QAF,	249
\$PASHS,NME,GGA,	202, 223	\$PASHS,RTC,REM,	249
\$PASHS,NME,GLL,	206	\$PASHS,RTC,REM,c,	46, 47
\$PASHS,NME,GRS,	207	\$PASHS,RTC,SEQ,	250
\$PASHS,NME,GSA,	209	\$PASHS,RTC,SPD,	250
\$PASHS,NME,GSN,	210	\$PASHS,RTC,SPD,9,	44
\$PASHS,NME,GSV,	213	\$PASHS,RTC,STH,	250
\$PASHS,NME,GXP,	215, 216	\$PASHS,RTC,STI,	44, 251
\$PASHS,NME,MSG,	45, 217	\$PASHS,RTC,TYP,	249, 251
\$PASHS,NME,PER,	66, 223	\$PASHS,SAV,	128, 134
\$PASHS,NME,POS,	96, 117	\$PASHS,SAV,Y,	46, 47, 48
\$PASHS,NME,RMC,	227	\$PASHS,SEM,	14
\$PASHS,NME,RRE,	228	\$PASHS,SES,	129
\$PASHS,NME,SAT,	231	\$PASHS,SES,PAR,	129

\$PASHS,SES,SET,	129
\$PASHS,SIT,	44, 60, 134, 270
\$PASHS,SPD,	134
\$PASHS,SPD,c,d,	46, 47, 48
\$PASHS,SVS,	135
\$PASHS,TST,	138
\$PASHS,UBP,	43
\$PASHS,UDD,	73, 281
\$PASHS,UDG,	75
\$PASHS,UNH,	139
\$PASHS,USE,	139
\$PASHS,VDP,	139
\$PASHS,WAK,	139
\$WIXDR,	238
\$YXXDR,	238

Numerics

1PPS out,	21
2-D,	224

A

accuracy,	2
accuracy,real-time monitoring,	53
ALT Fix Mode,	17
altitude error,	213
altitude held fixed,	224
ambiguity fixing reliability,	53
ANT,	162, 259, 260, 266
antenna offset,	43
antenna phase center,	90, 259
Antenna Reduction,	30
Auto Differential Mode,	54
autonomous position,	4

B

backward compatibility,	233
Base data latency,	52
base station,	33
baseline length,	5

C

CA code,	5
carrier loop,	108
carrier phase initialization,	52
CBN,	59
code loop,	108
COG,	238
communication link,	33
CSN,	93
CTS,	94

D

daisy chain mode,	18
data	
output,	21
recording,	8
structure,	11
transferring,	22
dead reckoning,	204
default parameters,	23
D-file,	95
differential	
correction,	55
GPS,	33
differential & RTK base station setup,	35
differential base station setup,	33
differential remote station setup,	46
disable differential mode,	249
DOI,	9, 145
DOP,	209
DRI,	9, 145
dynamics,	108

E

ellipsoidal altitude,	224
ellipsoidal height,	88
ELM,	15
EMER,	72
Enable Type of Message,	251

EOT, 265
 event marker, 19, 233
 event marker message, 225
 event marker option (E), 233

F

fast RTK mode, 40
 FAT, 92
 firmware version, 224

G

geodetic coordinates, 71
 geoidal separation, 224
 GGA, 46
 GLL, 46
 GPS time, 226
 GPSTopo, 4, 59
 GPS-to-UTC, 106
 grid coordinates, 71
 ground plane, 259
 GRS, 207
 GSN, 210
 GSV, 214
 GXP, 216

H

handshaking, 92, 94

I

ICD-GPS-200, 106
 IEEE format, 59
 initialization, 7
 integer ambiguity resolution, 52
 IODE, 218

K

Kalman, 276

L

L1, 94
 L2, 94
 latency, 49
 latitude error, 213
 LC27, 72
 LC83, 72
 longitude error, 213
 loop tracking parameters, 108
 LTZ, 111, 113, 136

M

magnetic variation, 227
 memory card, 4
 message rate, 39
 monitoring accuracy, 53
 multipath mitigation, 27

N

NAD27, 72
 NME,POS, 223
 NMEA period, 233
 NMEA satellite range residual, 207
 NMEA Version 2.3, 233
 NMEA Version 3.0, 233

O

OBN, 59, 270
 OM83, 72
 options, 2
 OUT, 145

P

parameters	
saving,	8
setting,	7
PBN,	46
PCMCIA,	4, 7, 11, 92
P-code,	5
PDOP,	58, 59
PEM,	15
performance,	2
PNAV,	276
point positioning,	18
port protocol,	92
POS,	46, 275
position	
horizontal,	215
mode,	17
position latency,	52
post-fit residuals,	208
PPO,	4
PRC,	218
protocol for a specified port,	94

R

raw measurements,	58
RCI,	145
reference station,	33, 44
reliability, ambiguity fixing,	53
remote monitoring,	18
remote option,	56
remote.exe,	4, 60
RRC,	218
RTC,OFF,	249
RTC,TYP,	251
RTCM	
reference,	217
RTCM 104,	55, 56
RTCM message bit rate,	39
RTCM-104,	3
RTK base station setup,	34
RTK remote station setup,	46

S

satellite	
in-view,	213
residual and position error,	228
status,	231
second azimuth,	14
SEM,	14
session programming,	15
set site name.,	60
setup	
differential & RTK base station,	35
differential base station,	33
differential remote station,	46
RTK base station,	34
RTK remote station,	46
shutter timing,	20
signal strength,	210
signal-to-noise,	93
six-of-eight format,	56
SNR,	30
SOG,	238
speed over ground,	224
SPS,	204
STER,	72
surveys, static,	140
synchronization,	22
synchronized RTK mode,	40

T

time and date message,	238, 240
time tag latency,	226
TM27,	72
TM83,	72
TMA7,	72
true course,	227
true track/course,	224
TTT,	4, 225
TYP,	249

U

UBN,	59
URDE),	218
user-selectable frequencies,	4
UTC,	240

V

V23,	204, 233
V30,	204, 233
vector solution,	270
velocity/course,	236
vertical velocity,	224

W

WGS-72,	73
WGS-84,	73, 79, 201

X

XDR,	238
------------	-----

Z

ZDA,	109, 238
------------	----------

