

C141-C010-01EN

**MAW3073, MAW3147, MAW3300 NP/NC SERIES
MAX3036, MAX3073, MAX3147 NP/NC SERIES
DISK DRIVES
SCSI LOGICAL INTERFACE SPECIFICATIONS**

FOR SAFE OPERATION

Handling of This Manual

This manual contains important information for using this product. Read thoroughly before using the product. Use this product only after thoroughly reading and understanding especially the section "Important Alert Items" in this manual. Keep this manual handy, and keep it carefully.

FUJITSU makes every effort to prevent users and bystanders from being injured or from suffering damage to their property. Use the product according to this manual.

About This Product

This product is designed and manufactured for use in standard applications such as office work, personal devices and household appliances. This product is not intended for special uses (atomic controls, aeronautic or space systems, mass transport controls, medical devices for life support, or weapons firing controls) where particularly high reliability requirements exist, where the pertinent levels of safety are not guaranteed, or where a failure or operational error could threaten a life or cause a physical injury (hereafter referred to as "mission-critical" use). Customers considering the use of these products for mission-critical applications must have safety-assurance measures in place beforehand. Moreover, they are requested to consult our sales representative before embarking on such specialized use.

First Edition

This manual is for internal use only. Fujitsu takes no responsibility for any other use.

The contents of this manual may be revised without prior notice.

The contents of this manual shall not be disclosed in any way or reproduced in any media without the express written permission of Fujitsu Limited.

All Rights Reserved, Copyright © FUJITSU LIMITED 2005

Revision History

(1/1)

Edition	Date	Revised section (*1) (Added/Deleted/Altered)	Details
01	August, 2005	—	—

1 Section(s) with asterisk () refer to the previous edition when those were deleted.

This page is intentionally left blank.

Preface

This manual explains concerning the MAW3073NP/NC, MAW3147NP/NC, MAW3300NP/NC, MAX3036NP/NC, MAX3073NP/NC, MAX3147NP/NC series 3.5 inch hard disk drives with internal SCSI controller.

The purpose of this manual is to provide specifications of each command and detailed explanations of their functions for use of these magnetic disk drives incorporated into user systems, and to present the information necessary for creating host system software. This manual is written for users who have a basic knowledge of hard disk drives and their use in computer systems.

The composition of manuals related to these disk drives and the range of subjects covered in this manual are shown in "Manual Organization," provided on a subsequent page. Please use these other manuals along with this manual as necessary.

Overview of Manual

This manual consists of the following six chapters, glossary, abbreviation, and index:

Chapter 1 Command Processing

This chapter describes the basic logical specifications related to SCSI command processing in the disk drives.

Chapter 2 Data Buffer Management

This chapter describes the data buffer configuration provided in the disk drives and concerning data transfer processing functions and cache operation.

Chapter 3 Command Specifications

This chapter describes specifications of SCSI commands provided by the disk drives and how to use them.

Chapter 4 Parameter Data Formats

This chapter describes the parameter data formats provided by the disk drives and how to use them.

Chapter 5 Sense Data Error Recovery Methods

This chapter describes the configuration and contents of sense data which report to the host system when an error occurs, etc., key information necessary for error recovery, recommended procedures for error recovery to be executed through host system software and retry processing executed internally in the disk drives for recovery

Chapter 6 Disk Media Management

This chapter describes the procedure for initializing the disk media, methods of treating media defects and data recovery methods for the disk drives.

Glossary

The glossary explains technical terms which are necessary to the reader's understanding when reading this manual.

Acronyms and Abbreviations

This list shows the full spelling of abbreviations used in this manual.

The model name of disk drives covered by this manual differs in its ending suffix (Note 1) depending on its device type (3 types), the electrical conditions of the SCSI interface used to connect the disk drive to the host system and its capacity and data format at the time it was shipped, but in this manual, except in cases where models need to be especially distinguished, a representative model name (Note 2) is used. In addition, these disk drives are called Intelligent Disk Drive (IDD), "drive" or "device" in this manual.

CONVENTIONS USED IN THIS MANUAL

Note 1: Model Name

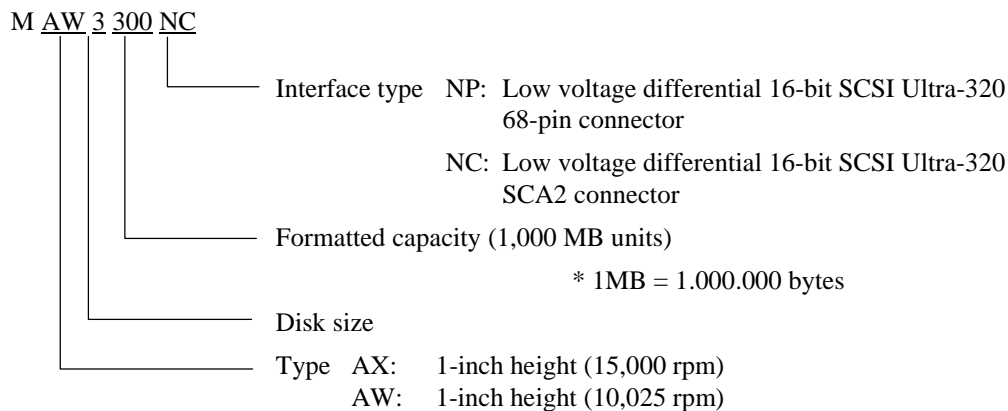

Note 2: Typical model name

Type model name	Model name
MAW3300	MAW3300NP, MAW3300NC
MAW3147	MAW3147NP, MAW3147NC
MAW3073	MAW3073NP, MAW3073NC
MAX3147	MAX3147NP, MAX3147NC
MAX3073	MAX3073NP, MAX3073NC
MAX3036	MAX3036NP, MAX3036NC

Warning Indications

The following warning indications are shown in this manual to prevent the user and other nearby persons or property from being injured or damaged.

Note “Note” indicates the most effective method of use or information that is of value to the user.

Requesting for User’s Comments

Please use the User’s Comment Form attached to the end of this manual to identify user comments including error, inaccurate and misleading information of this manual. Contact to your Fujitsu representative for additional comment forms if required.

Related Standards

Specifications and functions of products covered by this manual comply with the following standards.

Standard (Text) No.	Name	Enacting Organization
ANSI X3. 131-1986	American National Standard for Information Systems --- Small Computer System Interface (SCSI)	American National Standards Institute (ANSI)
ANSI X3. 131-1994	American National Standard for Information Systems --- Small Computer System Interface-2 (SCSI-2)	American National Standards Institute (ANSI)
X3T9.2/85-52 Rev 4.B	COMMON COMMAND SET (CCS) of the Small Computer System Interface (SCSI)	American National Standards Institute (ANSI)
X3T9.2 855D Rev 12	WORKING DRAFT Information Technology SCSI-3 Parallel Interface	American National Standards Institute (ANSI)
T10/1236-D Rev 20	Information technology SCSI Primary Commands-2 (SPC-2)	American National Standards Institute (ANSI)
T10 project 996D Rev 8C	Information Technology --- SCSI-3 Block Commands (SBC)	American National Standards Institute (ANSI)
T10/1157D Rev 24	Information technology SCSI-3 Architecture Model (SAM2)	American National Standards Institute (ANSI)
T10/1356D Rev 10	Information technology SCSI Parallel Interface-4 (SPI4)	American National Standards Institute (ANSI)

Attention

Please forward any comments you may have regarding this manual.

To make this manual easier for users to understand, opinions from readers are needed. Please write your opinions or requests on the Comment at the back of this manual and forward it to the address described in the sheet.

MANUAL ORGANIZATION

Product/
Maintenance Manual
(C141-E234/C141-E235)

1. General Description
2. Specifications
3. Data Format
4. Installation Requirements
5. Installation
6. Diagnostics and Maintenance
7. Error Analysis

SCSI Physical
Interface Specifications
(C141-C011)

1. SCSI Bus
2. SCSI Message
3. Error Recovery

SCSI Logical Interface Specifications
(C141-C010)

(This Manual)

1. Command Processing
2. Data Buffer Management
3. Command Specifications
4. Parameter Data Formats
5. Sense Data Error Recovery Methods
6. Disk Media Management

This page is intentionally left blank.

Contents

CHAPTER 1 Command Processing	1-1
1.1 Command Format	1-1
1.2 Status	1-6
1.3 Outline of Command Processing	1-8
1.3.1 Single commands	1-8
1.3.2 Command link	1-9
1.3.3 Disconnect/reconnect processing	1-11
1.3.4 Synchronous mode data transfer/wide mode data transfer	1-15
1.4 Command Queuing Function.....	1-16
1.4.1 Untagged queuing.....	1-16
1.4.2 Tagged queuing	1-18
1.5 UNIT ATTENTION Condition	1-19
1.5.1 Generation of the UNIT ATTENTION condition	1-19
1.5.2 Response and release condition at UNIT ATTENTION condition hold state.....	1-20
1.5.3 UNIT ATTENTION condition multiple hold.....	1-22
1.6 Sense Data Hold State	1-22
1.6.1 Sense data hold condition	1-22
1.6.2 Response and release conditions at sense data hold state	1-22
1.7 Command Processing Exceptions.....	1-23
1.7.1 Overlapping commands.....	1-23
1.7.2 Illegal LUN specification	1-24
1.7.3 Reserved operation code.....	1-24
1.7.4 Command processing in the not ready state	1-24
1.7.5 Error recovery processing	1-26
1.7.6 Reset processing	1-28
1.7.7 Fatal hardware errors.....	1-29
1.8 Data Block Addressing	1-30
1.8.1 Definition of data space.....	1-30
1.8.2 Logical block addressing.....	1-32
CHAPTER 2 Data Buffer Management	2-1
2.1 Data Buffer	2-1
2.1.1 Data buffer configuration and basic operation	2-1

2.1.2	Operation mode setting.....	2-5
2.2	Look-Ahead Cache Feature	2-6
2.2.1	Caching operation.....	2-6
2.2.2	Caching parameters	2-9
2.2.3	Look-Ahead operation, Look-Ahead volume.....	2-10
2.3	Write Cache	2-11
 CHAPTER 3 Command Specifications		3-1
3.1	Control/Sense Commands.....	3-1
3.1.1	TEST UNIT READY (00).....	3-1
3.1.2	INQUIRY (12).....	3-2
3.1.3	READ CAPACITY (25).....	3-13
3.1.4	CHANGE DEFINITION (40)	3-14
3.1.5	MODE SELECT (15).....	3-19
3.1.6	MODE SELECT EXTENDED (55).....	3-27
3.1.7	MODE SENSE (1A).....	3-30
3.1.8	MODE SENSE EXTENDED (5A).....	3-38
3.1.9	REZERO UNIT (01)	3-41
3.1.10	START/STOP UNIT (1B).....	3-41
3.1.11	RESERVE (16).....	3-43
3.1.12	RESERVE EXTENDED (56).....	3-46
3.1.13	RELEASE (17).....	3-47
3.1.14	RELEASE EXTENDED (57).....	3-48
3.1.15	REQUEST SENSE (03)	3-48
3.1.16	LOG SELECT (4C).....	3-50
3.1.17	LOG SENSE (4D)	3-54
3.1.18	PERSISTENT RESERVE IN (5E).....	3-55
3.1.18.1	PERSISTENT RESERVE IN service actions.....	3-56
3.1.18.1.1	READ KEYS	3-56
3.1.18.1.2	READ RESERVATIONS	3-57
3.1.18.2	PERSISTENT RESERVE IN parameter data for READ KEYS	3-57
3.1.18.3	PERSISTENT RESERVE IN parameter data for READ RESERVATIONS	3-58
3.1.18.3.1	Persistent reservation scope	3-59
3.1.18.3.2	Persistent reservations type	3-60
3.1.19	PERSISTENT RESERVE OUT (5F)	3-62
3.1.19.1	PERSISTENT RESERVE OUT service actions	3-63
3.1.19.2	PERSISTENT RESERVE OUT parameter list.....	3-64
3.1.20	REPORT LUNS (A0).....	3-66

3.1.21	REPORT DEVICE IDENTIFIER (A3).....	3-68
3.1.22	SET DEVICE IDENTIFIER (A4).....	3-69
3.2	Data Access Commands	3-71
3.2.1	READ (08)	3-71
3.2.2	READ EXTENDED (28)	3-72
3.2.3	WRITE (0A).....	3-73
3.2.4	WRITE EXTENDED (2A).....	3-74
3.2.5	WRITE AND VERIFY (2E)	3-75
3.2.6	VERIFY (2F).....	3-76
3.2.7	SEEK (0B).....	3-77
3.2.8	SEEK EXTENDED (2B).....	3-77
3.2.9	SET LIMITS (33) (Not Supported).....	3-78
3.2.10	SYNCHRONIZE CACHE (35).....	3-80
3.3	Format Commands	3-81
3.3.1	FORMAT UNIT (04)	3-81
3.3.2	REASSIGN BLOCKS (07)	3-91
3.3.3	READ DEFECT DATA (37)	3-94
3.3.4	READ DEFECT DATA (B7)	3-98
3.4	Maintenance, Diagnostic Commands	3-99
3.4.1	SEND DIAGNOSTIC (1D).....	3-99
3.4.2	RECEIVE DIAGNOSTIC RESULTS (1C).....	3-106
3.4.3	WRITE BUFFER (3B)	3-110
3.4.4	READ BUFFER (3C).....	3-115
3.4.5	READ LONG (3E).....	3-119
3.4.6	WRITE LONG (3F)	3-120
3.4.7	WRITE SAME (41).....	3-121
CHAPTER 4 Parameter Data Formats.....		4-1
4.1	Mode Parameters	4-1
4.1.1	Read/Write error recovery parameters (page code = 1).....	4-1
4.1.2	Disconnect/reconnect parameters (page code = 2)	4-10
4.1.3	Format parameter (page code = 3).....	4-14
4.1.4	Drive parameter (page code = 4).....	4-18
4.1.5	Verify error recovery parameters (page code = 7)	4-19
4.1.6	Caching parameters (page code = 8)	4-21
4.1.7	Control mode parameters (page code = 0A).....	4-27
4.1.8	Notch parameter (page code = 0C).....	4-31
4.1.9	Port control parameter (page code = 19)	4-33

4.1.10	Informational exceptions control page (page code = 1C).....	4-43
4.1.11	Background control mode parameter (page code = 1C/subpage = 01).....	4-47
4.1.12	Additional error recovery parameters (page code = 21).....	4-48
4.2	Log Parameters	4-49
4.2.1	Supprot log page (X'00').....	4-49
4.2.2	Buffer overrun / underrun page (X'01')	4-50
4.2.3	Write error count page (X'02').....	4-51
4.2.3.1	Write errors recovered without delays (Page 02, Code 0000).....	4-51
4.2.3.2	Write errors recovered with possible delays (Page 02, Code 0001).....	4-52
4.2.3.3	Total posted write errors (Page 02, Code 0002).....	4-52
4.2.3.4	Total posted recoverable write errors (Page 02, Code 0003)	4-53
4.2.3.5	Total write bytes processed (Page 02, Code 0005).....	4-53
4.2.3.6	Total posted unrecoverable write errors (Page 02, Code 0006)	4-54
4.2.4	Read error count page (X'03').....	4-54
4.2.4.1	Read errors recovered without delays (Page 03, Code 0000).....	4-55
4.2.4.2	Read errors recovered with possible delays (Page 03, Code 0001).....	4-55
4.2.4.3	Total posted read errors (Page 03, Code 0002)	4-56
4.2.4.4	Total posted recoverable read errors (Page 03, Code 0003).....	4-56
4.2.4.5	Total read bytes processed (Page 03, Code 0005).....	4-57
4.2.4.6	Total posted unrecoverable read errors (Page 03, Code 0006).....	4-57
4.2.5	Verify error count page (X'05').....	4-58
4.2.5.1	Verify errors recovered without delays (Page 05, Code 0000)	4-58
4.2.5.2	Vefiry errors recovered with possible delays (Page 05, Code 0001).....	4-59
4.2.5.3	Total posted verify errors (Page 05, Code 0002).....	4-59
4.2.5.4	Total posted recoverable verify errors (Page 05, Code 0003)	4-60
4.2.5.5	Total verify bytes processed (Page 05, Code 0005)	4-60
4.2.5.6	Total posted unrecoverable verify errors (Page 05, Code 0006).....	4-61
4.2.6	Non-medium error count page (X'06').....	4-61
4.2.7	Temperature page (X'0D')	4-62
4.2.7.1	Temperature (Page 0D, Code 0000).....	4-62
4.2.7.2	Reference temperature (Page 0D, Code 0001)	4-63
4.2.8	Start-stop cycle counter page (X'0E')	4-63
4.2.8.1	Date of manufacture (Page 0E, Code 0001).....	4-64
4.2.8.2	Accounting date (Page 0E, Code 0002)	4-64
4.2.8.3	Specified cycle count over device lifetime (Page 0E, Code 0003).....	4-65
4.2.8.4	Start-stop cycle counter (Page 0E, Code 0004).....	4-65
4.2.9	Application client page (X'0F').....	4-66

4.2.9.1	General usage application client parameter data (Page 0F, Code 0000-003F).....	4-66
4.2.10	Self-test result page (X'10')	4-67
4.2.10.1	Self-test result parameter data (Page 10, Code 0001-0014).....	4-67
4.2.11	Background medium scan page (X'15').....	4-69
4.2.11.1	Background medium scan status parameter	4-69
4.2.11.2	Background medium scan parameter	4-70
4.2.12	SMART status page (X'2F').....	4-71
4.2.13	SMART data page (X'38')	4-72
CHAPTER 5	Sense Data Error Recovery Methods	5-1
5.1	Sense Data	5-1
5.1.1	Sense data format	5-1
5.1.2	Sense data basic information	5-2
5.1.3	Sense data additional information	5-12
5.2	INIT Error Recovery Methods (Recommended).....	5-12
5.2.1	Termination status analysis and error recovery methods	5-12
5.2.2	Sense data analysis and error recovery methods	5-15
5.2.3	Error logging	5-22
5.3	Disk Drive Error Recovery Processing.....	5-23
5.3.1	Error states and retry processing procedures.....	5-23
5.3.2	Auto alternate block allocation processing.....	5-24
5.3.3	Error recovery processing control	5-26
CHAPTER 6	Disk Media Management.....	6-1
6.1	Defect Management.....	6-1
6.2	Disk Media Initialization	6-3
6.2.1	Initialization during installation.....	6-3
6.2.2	Re-initialization	6-5
6.3	Data Block Verification Methods (Recommended)	6-6
6.4	Alternate Block Allocation Processing.....	6-7
Glossary	GL-1
Acronyms and Abbreviations		AB-1
Index		IN-1

Illustrations

Figures

Figure 1.1	6-Byte CDB Basic Format.....	1-1
Figure 1.2	10-Byte CDB Basic Format.....	1-2
Figure 1.3	12-Byte CDB Basic Format.....	1-2
Figure 1.4	Status	1-6
Figure 1.5	Data space configuration	1-31
Figure 2.1	Data buffer configuration (in the case of 8 cache segments).....	2-2
Figure 2.2	Example of data buffer operation during read.....	2-3
Figure 2.3	Example of data buffer operation during write.....	2-4
Figure 2.4	Parameters for controlling reconnection timing	2-5
Figure 2.5	Cache control parameters	2-9
Figure 3.1	Standard INQUIRY data.....	3-4
Figure 3.2	Command support data.....	3-9
Figure 3.3	VPD information: VPD identifier list.....	3-11
Figure 3.4	VPD information: device serial No.	3-11
Figure 3.5	VPD information: operation mode	3-12
Figure 3.6	READ CAPACITY data.....	3-14
Figure 3.7	CHANGE DEFINITION command: operation mode parameter	3-16
Figure 3.8	MODE SELECT parameter structure	3-21
Figure 3.9	MODE SELECT command (Group 0) parameter configuration.....	3-23
Figure 3.10	MODE SELECT EXTENDED command (Group 2) parameter configuration.....	3-29
Figure 3.11	MODE SENSE command (Group 0) parameter configuration	3-34
Figure 3.12	MODE SENSE EXTENDED command (Group 2) parameter configuration	3-39
Figure 3.13	LOG, SELECT command: parameter list.....	3-51
Figure 3.14	LOG SELECT command: log parameter.....	3-52
Figure 3.15	PERSISTENT RESERVE IN command: parameter data (READ KEYS).....	3-57
Figure 3.16	PERSISTENT RESERVE IN command: parameter data (READ RESERVATIONS).....	3-58
Figure 3.17	PERSISTENT RESERVE IN Reservation Descriptor	3-59
Figure 3.18	PERSISTENT RESERVE OUT command: parameter list.....	3-64
Figure 3.19	REPORT LUNS command: parameter list.....	3-67
Figure 3.20	REPORT DEVICE IDENTIFIER: parameter list.....	3-68
Figure 3.21	SET DEVICE IDENTIFIER: parameter list	3-70
Figure 3.22	SET LIMITS command: Specifying the range where access is permitted	3-79
Figure 3.23	FORMAT UNIT command parameter list configuration	3-84
Figure 3.24	Defect descriptor: Byte distance from index format.....	3-87
Figure 3.25	Defect descriptor: physical sector address format	3-88
Figure 3.26	REASSIGN BLOCK command: defect data list configuration.....	3-92
Figure 3.27	READ DEFECT DATA command (37): Defect data configuration	3-95
Figure 3.28	READ DEFECT DATA command (B7): Defect data configuration.....	3-99
Figure 3.29	SEND DIAGNOSTIC command: parameter list configuration	3-102
Figure 3.30	SEND DIAGNOSTIC parameters: page code list	3-103
Figure 3.31	SEND DIAGNOSTIC parameters: logical/physical address conversion	3-104
Figure 3.32	RECEIVE DIAGNOSTIC RESULTS command: Response data configuration.....	3-107
Figure 3.33	RECEIVE DIAGNOSTIC RESULTS response data: page code list	3-108
Figure 3.34	RECEIVE DIAGNOSTIC RESULTS response data: logical/physical address conversion.....	3-108
Figure 3.35	WRITE BUFFER command: buffer data (Mode = 000, 001).....	3-111
Figure 3.36	READ BUFFER command: buffer data (Mode = 0000, 0001).....	3-116
Figure 3.37	READ BUFFER command: buffer descriptor.....	3-117
Figure 3.38	READ BUFFER command: Echo buffer descriptor.....	3-118

Figure 4.1	MODE SELECT parameters: read/write error recovery parameters	4-2
Figure 4.2	MODE SELECT parameters: disconnect/reconnect parameters	4-10
Figure 4.3	MODE SELECT parameters: format parameters	4-14
Figure 4.4	MODE SELECT parameters: each parameters of pages 3, 4, and C in detail.....	4-17
Figure 4.5	MODE SELECT parameters: drive parameters.....	4-18
Figure 4.6	MODE SELECT parameters: verify error recovery parameters	4-20
Figure 4.7	MODE SELECT parameters: caching parameters	4-22
Figure 4.8	MODE SELECT parameters: control mode parameters.....	4-27
Figure 4.9	MODE SELECT parameters: notch parameter	4-31
Figure 4.10	MODE SELECT parameters: port control parameter.....	4-33
Figure 4.11	MODE SELECT parameters: informational exception control.....	4-43
Figure 4.12	MODE SELECT parameters: additional error recovery parameters	4-48
Figure 5.1	Expanded sense data format	5-2
Figure 5.2	Sense key inherent information	5-4
Figure 5.3	Analysis of the termination status	5-13

Tables

Table 1.1	Responses to Link Specification Commands	1-10
Table 1.2	Types of Command and Disconnect Processing	1-12
Table 1.3	Sense data in not ready state.....	1-25
Table 1.4	Outline of SCSI Bus Error Recovery Processing	1-27
Table 1.5	Outline of disk drive error recovery processing	1-27
Table 1.6	Reset processing during write.....	1-29
Table 3.1	MODE SENSE Data Type Specifications	3-33
Table 3.2	Persistent reservation type codes	3-61
Table 3.3	PERSISTENT RESERVE OUT command service action codes	3-64
Table 3.4	PERSISTENT RESERVE OUT service actions and valid parameters	3-66
Table 3.5	FORMAT UNIT command defect processing	3-89
Table 3.6	Error recovery control flags during the self-diagnosis test.....	3-101
Table 4.1	Combinations of error recovery flags	4-7
Table 4.2	MRIE (Methods of reporting informational exception conditions).....	4-45
Table 4.3	Self-test results values	4-68
Table 5.1	Sense key	5-5
Table 5.2	Additional sense code and additional sense code qualifier.....	5-6
Table 5.3	Sense data error classification	5-15
Table 5.4	Error recovery processing procedures	5-18
Table 5.5	Disk drive errors and number of retries.....	5-27

This page is intentionally left blank.

CHAPTER 1 Command Processing

- 1.1 Command Format
- 1.2 Status
- 1.3 Outline of Command Processing
- 1.4 Command Queuing Function
- 1.5 UNIT ATTENTION Condition
- 1.6 Sense Data Hold State
- 1.7 Command Processing Exceptions
- 1.8 Data Block Addressing

This chapter describes the basic logical specifications of the IDD command processing functions.

Note: The IDD operates as the target (TARG) on the SCSI bus. In the explanations in this chapter, the IDD is mentioned as “TARG”, except in cases where a particularly clear distinction is necessary.

1.1 Command Format

Input/output operation commands from INIT (initiator) to the IDD are accomplished by the CDB (Command Descriptor Block). The CDB is information transferred from INIT to TARG in the COMMAND phase. In a number of commands, the parameters which are necessary for command execution in the DATA OUT phase may be specified in addition to the CDB specification. Details concerning these are described in the specifications for each individual command in Chapter 3.

The CDB used by the IDD has 3 formats, these formats have length of 6, 10 and 12 bytes. The basic format of each respective CDB is shown in Figures 1.1, 1.2 and 1.3.

Byte \ Bit	7	6	5	4	3	2	1	0
0	Operation Code							
1	LUN			Logical Block Address (MSB)				
2	Logical Block Address							
3	Logical Block Address (LSB)							
4	Transfer Data Length							
5	Control Byte							

Figure 1.1 6-Byte CDB Basic Format

Byte \ Bit	7	6	5	4	3	2	1	0
0	Operation Code							
1	LUN			0	0	0	0	0
2	Logical Block Address (MSB)							
3	Logical Block Address							
4	Logical Block Address							
5	Logical Block Address (LSB)							
6	0	0	0	0	0	0	0	0
7	Transfer Data Length (MSB)							
8	Transfer Data Length (LSB)							
9	Control Byte							

Figure 1.2 10-Byte CDB Basic Format

Byte \ Bit	7	6	5	4	3	2	1	0
0	Operation Code							
1	LUN			0	0	0	0	0
2	Logical Block Address (MSB)							
3	Logical Block Address							
4	Logical Block Address							
5	Logical Block Address (LSB)							
6	Transfer Data Length (MSB)							
7	Transfer Data Length (LSB)							
8	Transfer Data Length (MSB)							
9	Transfer Data Length (LSB)							
10	0	0	0	0	0	0	0	0
11	Control Byte							

Figure 1.3 12-Byte CDB Basic Format

The meanings of each of the fields in the CDB are explained below. Depending on the type of command, the basic format of the CDB, the definitions of fields and their meanings may differ. Details are described in the specifications for each individual command in Chapter 3.

(1) Operation code

Bit 7	6	5	4	3	2	1	0
Group Code			Command Code				

The leading byte of all CDBs shows the format and type of command to be executed.

a. Group code

The group code specifies the number of bytes and format of the CDB. The groups of commands shown below are used in the IDD.

- Group 0 ("000"):6-byte CDB (Shown in Figure 1.1)
- Group 1 ("001"):10-byte CDB (Shown in Figure 1.2)
- Group 2 ("010"):10-byte CDB (Shown in Figure 1.2)
- Group 3 ("011"):Reserved Operation Code (Shown in (6))
- Group 4 ("100"):16-byte CDB
- Group 5 ("101"):12-byte CDB (Shown in Figure 1.3)
- Group 6 ("110"):Vendor unique code (Shown in Section 1.7.3)
- Group 7 ("111"):Vendor unique code (Shown in Section 1.7.3)

b. Command code

Command code specifies the type of command in each group.

(2) LUN (Logical Unit Number)

This field specifies the address of the logical unit (device) connected under the TARG in cases where the IDENTIFY message is not used. If the IDENTIFY message is used, the value of the CDB's LUN field is ignored when the LUN is specified.

Note:

It is possible that the definition of this field may be changed in future SCSI standards. It is recommended that the LUN be specified using the IDENTIFY message, and that a zero be specified in this CDB field.

(3) Logical block address

This field shows the leading logical data block address of the data block on the disk media to be processed by the command. In the group 0 CDB, 21-bit block addressing is possible and in the group 1, group 2 and group 5 CDBs, 32-bit block addressing is possible. Specifications for logical data block addressing in the IDD are described in Section 1.8.

(4) Transfer data length

In this field, the length of data to be transferred between INIT and TARG when the command is executed is specified by the number of logical data blocks or the number of bytes. In subsequent descriptions, the former is called the “transfer block count” and the latter is called the “transfer byte length” or “parameter list length.”

Furthermore, this field may be used with a different meaning, or it may not have any meaning at all, depending on the type of command. There are also some commands which allocate 3 or more bytes as the transfer data length field. Detailed specifications of these commands are described in the individual command specifications in Chapter 3.

a. Transfer block count

When the “Transfer Data Length” is specified as the “Transfer Block Count,” this field specifies the number of logical data blocks to be transferred between INIT and the IDD.

In commands where this field is 1 byte in length, if the field’s specified value is 0, it is regarded as specifying 256 blocks, and it is possible to specify a block count ranging from 1 to 256 blocks. On the other hand, in commands where this field is 2 bytes in length, if the field’s specified value is 0, no data transfer is executed. It is possible to specify a block count ranging from 0 to 65,535 blocks.

b. Transfer byte length or parameter list length

When this field is specified as the “Transfer Byte Length” or “Parameter List Length,” that command specifies data length to be transferred between the INIT and the IDD, expressed as the number of bytes. When 0 is specified in this field, data transfer is not executed, except in cases where it is expressly stated in the individual command specifications in Chapter 3.

In commands which send parameters necessary for executing a command from the INIT to the IDD, this field is called the “Parameter List Length,” and it specifies the total number of types in the parameter list which the INIT is sending.

On the other hand, in commands for receiving information from the IDD (REQUEST SENSE, INQUIRY, etc.), this field is called the “Transfer Byte Length,” and specifies the maximum number of bytes which the INIT can receive (the number of bytes of area secured within the INIT for receiving information). The IDD transfers either the number of effective bytes of the type of information specified in the command, or the value specified in the “Transfer Byte Length” field, whichever is the smallest number of bytes, and only that number, to the INIT.

(5) Control byte

Bit 7	6	5	4	3	2	1	0
0	0	0	0	0	0	0	Link

a. Link

Command link is specified by this bit is “1.” Details of the operation of the command link are described in Section 1.3.2.

b. Bit 7, 6 (vendor unique)

When 1 is specified in these bits, the command ends with a CHECK CONDITION status.

(6) Handling an illegal CDB

If there is an error in the contents of a description (specification) in the CDB, or if there is an error in the specifications in parameters transferred from the INIT by CDB specifying, that command ends with a CHECK CONDITION status. In the case of a command to change the data on the disk media, when there is an error in the CDB’s specifications, the disk media is not changed by that command. But when there is an error in the parameters transferred in the DATA OUT phase, the contents of the disk media in the range specified by the command may be changed. Also, even in cases where there is an error in the CDB’s specifications in a command accompanying the DATA OUT phase, the DATA OUT phase is executed after the COMMAND phase is terminated, but those data are not used. For example, if there is an error in the CDB specification of a WRITE command, the IDD executes the transfers several bytes of data (the data length to be transferred is not specified), but those data are not written to the disk media. Details are described in the individual command specifications in Chapter 3.

If there is an error in the CDB specification in a command which executes disconnect processing (shown in Section 1.3.3), the disconnect processing may be executed after the COMMAND phase is terminated. In this case, reconnect processing is executed afterward and the status (CHECK CONDITION) is reported.

Note:

If a CDB with an undefined group code (group 3) is specified, the IDD requests transfer of 10 bytes in the COMMAND phase. After that has been received, the status (CHECK CONDITION) is reported.

1.2 Status

Figure 1.4 shows the type of status that the IDD supports.

The status is one byte of information sent from the TARG to the INIT in the STATUS phase when one command is completed, and notifies the INIT of the results of the command's execution. The status is also sent even in cases when the TARG is in a state which it makes it impossible for it to execute the command when it receives a request for an input/output operation. However, if the command is cleared by switching to the BUS FREE phase forcibly through an ABORT TASK SET message, an ABORT TASK message, a CLEAR TASK SET message, a TARGET RESET message, a RESET condition or a SCSI bus error state, etc., the status for that command is not reported.

After the TARG reports the status in the STATUS phase, it will always send a TASK COMPLETE message or a LINKED TASK COMPLETE (WITH FLAG) message to notify the INIT of the validity of the status.

Status code	Status
00h	GOOD Status
02h	CHECK CONDITION Status
04h	CONDITION MET Status
08h	BUSY Status
10h	INTERMEDIATE Status
14h	INTERMEDIATE CONDITION MET Status
18h	RESERVATION CONFLICT Status
22h	COMMAND TERMINATED Status
28h	TASK SET FULL Status

Figure 1.4 Status

(1) GOOD status

This status indicates that execution of the command ended normally.

(2) CHECK CONDITION status

This status is reported in the following cases a) to c). The IDD generates sense data when it reports this status and indicates the detailed cause. The INIT issues a REQUEST SENSE command when it receives this status and should sample sense data.

- a) If the sense key of the sense data indicates RECOVERED ERROR [=1], the last command, which is the last command, indicates that it ended normally with the error recovery processing executed by the IDD.
- b) If the sense key of the sense data indicates UNIT ATTENTION [=6], it indicates that the IDD was holding the UNIT ATTENTION condition. Details of the UNIT ATTENTION condition are described in Section 1.5.
- c) In cases other than the above, it indicates that command execution is impossible, or that command execution was terminated abnormally.

(3) CONDITION MET Status

This status is reported when it is possible to secure the cache memory area necessary for reading all the logical data blocks specified in the PRE-FETCH command (in the case of “Immed = 1”), or when reading of all the specified logical data blocks is completed (in the case of “Immed = 0”).

The IDD does not support the PRE-FETCH command. Therefore, this status is not reported.

(4) BUSY status

This status indicates that the IDD is in the busy state and it cannot receive a new command. Normally, an INIT that receives this status reissues the original command after waiting an appropriate period of time.

The IDD reports the BUSY status in the following cases (the command stack function is explained in Section 1.4).

- a) If the IDD receives a new command while it is executing or is queuing command (except a command without executing disconnect processing as shown in Section 1.3.3) but the INIT which issued that command does not satisfy the disconnect enable conditions.
- b) If the IDD receives a command without executing disconnect processing (as shown in Section 1.3.3) while it is executing or is queuing command.
- c) If the DISCONNECT message for command queuing has been rejected by the INIT while the IDD is executing or queuing command.
- d) If a command with executing untagged disconnect processing is received while the command queue is full.

(5) INTERMEDIATE status

This status indicates that a command which specifies a link (except the last command in a group of linked commands with “1” as its Link bit) has been completed normally. If a command which specifies a link is completed abnormally and the CHECK CONDITION status or RESERVATION CONFLICT status is reported, the command link is broken and the subsequent linked commands are not executed.

(6) INTERMEDIATE CONDITION MET Status

This status is reported when it is possible to secure the cache memory area necessary to read all the logical data blocks specified in a PRE-FETCH command which specifies a link (in the case of “Immed = 1”), or when reading of all the specified logical data blocks is completed (in the case of “Immed = 0”).

The IDD does not support the PRE-FETCH command. Therefore, this status is not reported.

(7) RESERVATION CONFLICT status

This status indicates that the IDD is reserved by another INIT, and that use is impossible until the reserved status is canceled. Normally, an INIT which receives this status reissues the original command after waiting an appropriate period of time.

(8) COMMAND TERMINATED status

This status is reported when the IDD has completed the executing input/output operation when it received a TERMINATE I/O PROCESS message from the INIT.

The IDD does not support the TERMINATE I/O PROCESS message. Therefore, this status is not reported.

(9) TASK SET FULL status

This status is reported if the IDD cannot register a received tagged command in the command queue because there is no empty space in the command queue.

1.3 Outline of Command Processing

1.3.1 Single commands

Following shows single command processing examples which are the most basic operations on the SCSI bus. Furthermore, if disconnect processing is permitted, it may be accompanied by disconnect/reconnect processing during the command execution, depending on the type of command, but this operation is omitted in the following explanation. The disconnect function is described in Section 1.3.3.

- 1) The INIT sets the initial values for the command in the command pointer, data pointer and status pointer.
- 2) The INIT selects the TARG in the SELECTION phase after obtaining the SCSI bus usage in the ARBITRATION phase. After the SELECTION phase is ended, the SCSI bus control is entrusted to the TARG.
- 3) If the ATTENTION condition exists when the TARG responds to the SELECTION phase, the TARG executes the MESSAGE OUT phase. Normally, the INIT sends the IDENTIFY message as the initial message and specifies the device (LUN) that is the object of the operation.

- 4) The TARG executes the COMMAND phase and receives the CDB from the INIT. The TARG judges the length of the CDB by the group code in the first byte of the CDB and requests transfer of the necessary number of bytes.
- 5) The TARG investigates the contents of the command and executes the requested operation. In the case of commands for which data transfer on the SCSI bus is necessary, the DATA IN or the DATA OUT phase is executed.
- 6) When execution of the command is completed, the TARG reports the execution results by the status in the STATUS phase to the INIT.
- 7) The TARG reports the TASK COMPLETE message to the INIT in the MESSAGE IN phase and enters the BUS FREE phase.

1.3.2 Command link

The command link function is a function which causes the TARG to execute continuous processing of multiple commands. Following shows examples of command link processing.

- 1) The INIT sets the initial values for the command in the command pointer, data pointer and status pointer.
- 2) Obtaining the SCSI bus usage, selection of the TARG and specification of the LUN by the IDENTIFY message are the same as in the case of single command.
- 3) The TARG receives commands from the INIT in the COMMAND phase, but “1” is specified in the Link bit of the control byte of the CDB.
- 4) The TARG analyzes the command and executes the requested processing.
- 5) If processing of the command is completed normally, the TARG reports the INTERMEDIATE status in the STATUS phase to the INIT. At this time, the command link function becomes effective.
- 6) The TARG informs the INIT of the LINKED TASK COMPLETE. When the INIT has received the LINKED TASK COMPLETE message, the command, data and status pointers are updated to the initial values for the next linked command.
- 7) The TARG enters the COMMAND phase immediately after the MESSAGE IN phase and receives the command to be executed next. After that, it performs either single command (Link bit = “0”) processing or command link (Link bit = “1”) processing.

The command link continues until a command with “0” specified in the Link bit of its CDB is issued or until a command terminates abnormally.

The command link function is made effective only in the case that commands with link specifications are completed normally. If a command with a link specification is completed in an error state or in an exception state, the command link function is invalidated. Table 1.1 shows the response of the IDD when commands with a Link specification are terminated.

Table 1.1 Responses to Link Specification Commands

End Status	Status	Message	Link Function
Completed Normally	INTERMEDIATE	LINKED TASK COMPLETE	Effective
Completed Abnormally	CHECK CONDITION	TASK COMPLETE	Not Effective
Conditions Met	INTERMEDIATE CONDITION MET	LINKED TASK COMPLETE	Effective
Unable to Start Receive	BUSY	TASK COMPLETE	Not Effective
Reserved State	RESERVATION CONFLICT	TASK COMPLETE	Not Effective
Forced Termination	COMMAND TERMINATED	TASK COMPLETE	Not Effective
Task Set Full State	TASK SET FULL	TASK COMPLETE	Not Effective

Only a single logical unit can operate a series of linked commands. When the IDD receives the first command, the logical unit specified by the IDENTIFY message or the LUN field of the CDB becomes the object of operation in a series of linked commands and the values specified in the LUN field in the second and subsequent CDBs are disregarded.

Note:

An INIT which uses the command link function must make the ATN signal in the SELECTION phase TRUE and notify the TARG that it is capable of receiving messages other than the TASK COMPLETE message. If “1” has been specified in the Link bit of the CDB without the ATN being made TRUE by the INIT in the SELECTION phase, the IDD terminates that command abnormally by sending a CHECK CONDITION status (ILLEGAL REQUEST [=5] / Invalid field in CDB [=24-00]).

1.3.3 Disconnect/reconnect processing

When processing is performed by the TARG during the command execution process which does not require operation on the SCSI bus, the TARG can return the SCSI bus to the BUS FREE phase temporarily by disconnect processing and execute command internally. Through this function, the INIT is enabled to process multiple commands on the SCSI bus.

(1) Disconnect permission conditions and commands with executing disconnect process

If all of the conditions shown below for permitting a disconnect are satisfied, the IDD executes disconnect processing. However, As shown in Table 1.2, disconnect processing may be valid or invalid, and the disconnect processing execution timing may differ, depending on the type of command.

Conditions for Permitting a Disconnect

- 1) The SCSI ID of the INIT is notified in the SELECTION phase.
- 2) The INIT generates the ATTENTION condition in the SELECTION phase.
- 3) The INIT notifies the TARG that disconnect processing is permitted by an IDENTIFY message.

Table 1.2 Types of Command and Disconnect Processing

C	CHANGE DEFINITION	(40)		O
F	FORMAT UNIT	(04)		O
I	INQUIRY	(12)	O	
L	LOG SELECT	(4C)		O
	LOG SENSE	(4D)		O
M	MODE SELECT	(15)		O
	MODE SELECT EXTENDED	(55)		O
	MODE SENSE	(1A)		O
	MODE SENSE EXTENDED	(5A)		O
N				
P	PERSISTENT RESERVE IN	(5E)		O
	PERSISTENT RESERVE OUT	(5F)		O
R	READ	(08)		O
	READ BUFFER	(3C)		O
	READ CAPACITY	(25)		O
	READ DEFECT DATA	(37)		O
	READ DEFECT DATA	(B7)		O
	READ EXTENDED	(28)		O
	READ LONG	(3E)		O
	REASSIGN BLOCKS	(07)		O
	RECEIVE DIAGNOSTIC RESULTS	(1C)		O
	RELEASE	(17)		O
	REPORT DEVICE IDENTIFIER	(A3)		O
	REPORT LUN	(A0)	O	
	REQUEST SENSE	(03)	O	
	RESERVE	(16)		
	REZERO UNIT	(01)		O
S	SEEK	(0B)		O
	SEEK EXTENDED	(2B)		O
	SEND DIAGNOSTIC	(1D)		O
	SET DEVICE IDENTIFIER	(A4)		O
	START/STOP UNIT	(1B)		O
	SYNCHRONIZE CACHE	(35)		O
T	TEST UNIT READY	(00)	O	
V	VERIFY	(2F)		O
W	WRITE	(0A)		O
	WRITE AND VERIFY	(2E)		O
	WRITE BUFFER	(3B)		O
	WRITE EXTENDED	(2A)		O
	WRITE LONG	(3F)		O
	WRITE SAME	(41)		O

(Note 1) Commands without executing disconnect processing: In cases only where commands are issued without a tag, queuing processing (see Section 1.4) and disconnect processing cannot be performed in the execution sequence.

(Note 2) Commands with executing disconnect processing: Regardless of command queuing, in a command's execution process (after the COMMAND phase is completed, or during or after the completion of data transfer), disconnect processing is performed. However, in the case of commands with a data state (in cases where it is hit in the cache, etc.), or with a number of processing modes, other than cases where the command is in a queue, disconnect processing may not be executed depending on the processing content specification of the command.

(2) Basic disconnect processing procedure

Disconnect processing is executed basically by the following processing procedure.

- 1) If the IDD judges that it is possible for it to disconnect from the SCSI bus during execution of a command, it sends a DISCONNECT message to the INIT and enters the BUS FREE phase. At this time, if necessary, the IDD sends a message to activate a pointer in the INIT which precedes sending of the DISCONNECT message. Furthermore, for details concerning pointers, refer to the SCSI pointer description in “SCSI Physical Interface Specifications” and “Chapter 2 SCSI Messages.”
- 2) After the IDD enters the BUS FREE phase, it is possible for the INIT to issue other commands. Also, it is possible for an IDD which has performed disconnect processing to receive input/output operation requests from each INIT (this is explained in the description of the command queuing function in Section 1.4).
- 3) The IDD executes the command which performs disconnect processing internally.
- 4) After that, the IDD executes reconnection processing at the point, when it is necessary for operation on the SCSI bus, to reconnect with the INIT (See item (6) concerning reconnection processing).

(3) Disconnect processing procedure after COMMAND phase execution

If commands are queued (see Section 1.4), disconnect processing is performed immediately after the COMMAND phase execution is completed. In this case, the IDD switches from the COMMAND phase to the MESSAGE IN phase and sends the DISCONNECT message to the INIT.

(4) Disconnect processing procedure after data transfer execution

For commands which accompany a data transfer, disconnect processing may be performed during DATA IN or DATA OUT phase execution or after transfer of the last data is completed. In this case, caution is necessary when executing the following types of pointer controls.

a. If disconnecting during a data transfer

In cases where data transfer has begun (in DATA IN or DATA OUT phase) and it will take time until transfer of subsequent data can be transferred (example: When the data buffer has been emptied by a READ command, or the data buffer has ceased to be empty due to a WRITE command), disconnect processing is performed during data transfer. In this case, the IDD sends the SAVE DATA POINTER message before sending the DISCONNECT message. When the INIT receives the SAVE DATA POINTER message, it must save the current value of the current data pointer and make it possible to transfer data from the subsequent data at reconnection time.

b. If disconnecting after the final data transfer is completed

In the case of a disconnect after transfer of all the data necessary for execution of a command has been completed normally, (example: a WRITE command), the IDD sends a DISCONNECT message after sending the SAVE DATA POINTER message.

After that, the IDD executes reconnection processing and enters the STATUS phase immediately and reports the status without requesting a data transfer.

Note:

In disconnect processing in this case, transfer of all the data accompanying execution of the command is complete and there is actually no necessity for the SAVE DATA POINTER message.

However, by issuing the SAVE DATA POINTER message, processing time increases due to the message transfer, but as a result of the pointer restore operation that is executed internally by the INIT during reconnection processing for the status report, the current data pointer can reflect the final results of the data transfer.

(5) Disconnect processing exceptions

When the previously mentioned disconnect processing is executed, if the ATTENTION condition is generated for the DISCONNECT message sent by the IDD and the INIT returns the MESSAGE REJECT message, the IDD executes the command with the connections to the SCSI bus remaining as is, without executing disconnect processing. Cases of disconnect processing in which a pointer operation is necessary and the SAVE DATA POINTER message is rejected are the same.

(6) Reconnection processing procedure

The reconnection processing procedure is as shown below.

- 1) The IDD executes the ARBITRATION phase at the point when processing on the SCSI bus is necessary and gets the SCSI bus control right, then reconnects with the INIT in the RESELECTION phase.
- 2) After that, the IDD sends the IDENTIFY message to the INIT and notifies it of the logical unit number (LUN) necessary for reconnection processing. If a tagged queuing command is executed, the IDD sends the SIMPLE message to inform the INIT of the tag ID. The INIT reads the Saved pointer (command, data and status) corresponding to the LUN specified at this time and restores it to the current pointer.

Note:

- 1) If there is no response from the INIT within the specified time (default: 250 ms) in the RESELECTION phase, the IDD performs timeout processing, then enters the BUS FREE phase. In this case, after waiting 200 ms or longer, the IDD executes the predetermined number of retries (re-executing the RESELECTION phase). However, if it still cannot reconnect with the INIT after that, the IDD clears the command necessary for reconnection processing and generates sense data indicating ABORTED COMMAND[=B]/Select /Reselect failure[=45-00].
- 2) If the INIT rejects the IDENTIFY message, or if it rejects the SIMPLE message when executing a tagged queuing command, the IDD clears the command that was being executed during reconnection processing and enters the BUS FREE phase. In this case, the IDD generates sense data indicating ABORTED COMMAND[=B]/Message error[=43-00].

- 3) After the INIT that accepts the IDENTIFY message normally completes the pointer restore operation, it should make the ACK signal for the IDENTIFY message FALSE. If the ATTENTION condition does not exist when the ACK signal becomes FALSE during sending of the IDENTIFY message, the IDD regards the reconnection processing as having been normally completed and begins subsequent processing.

For further details, refer to CHANGE DEFINITION parameter list (Reselection Retry, Reselection Time-out Delay) in Section 3.1.4 and SCSI Bus (RESELECTION phase) in Chapter 1 of “SCSI Physical Interface Specifications” and SCSI Bus Error Recovery Processing in Chapter 3.

1.3.4 Synchronous mode data transfer/wide mode data transfer

The IDD equips a synchronous mode data transfer function and wide mode data transfer function for processing high speed data transfers (DATA IN and DATA OUT phases) on the SCSI bus. Data transfers on the SCSI bus can be executed in any desired combination of the asynchronous mode or synchronous mode and in 8 bit widths or 16 bit widths (wide mode), but by using synchronous mode data transfer or wide mode data transfer, command processing time is shortened and throughput for input/output processing by multiple command processing using idle time on the SCSI bus can be improved.

After IDD power on, after generating a RESET condition on the SCSI bus or after one of the INITs issues a TARGET RESET message, the data transfer mode (default mode) of the IDD is the asynchronous mode. To use wide mode data transfer, the INIT must exchange a WIDE DATA TRANSFER REQUEST message or PARALLEL PROTOCOL REQUEST message with the IDD, and determine the SCSI bus width. To use the synchronous mode data transfer, the INIT must exchange the SYNCHRONOUS DATA TRANSFER REQUEST message or PARALLEL PROTOCOL REQUEST message and determine parameters necessary for executing the synchronous mode transfer. When exchange of the WIDE DATA TRANSFER REQUEST message or PARALLEL PROTOCOL REQUEST message is completed, if the synchronous mode has been established between the INIT and IDD previously, note that the asynchronous mode is set.

The INIT which uses wide mode data transfer normally sends the WIDE DATA TRANSFER REQUEST or PARALLEL PROTOCOL REQUEST message to the IDD following the IDENTIFY message after the initial SELECTION phase, and requests the TARG (IDD) to set the SCSI bus width in the wide mode. Also, if synchronous mode data transfer is used, after establishing the SCSI bus width, the INIT exchanges the SYNCHRONOUS DATA TRANSFER REQUEST message or PARALLEL PROTOCOL REQUEST message and requests the TARG (IDD) to set the synchronous data transfer mode.

The data transfer mode set with the INIT once is effective until a RESET condition occurs or until a TARGET RESET message is issued by any INITs. Therefore, in order for the INIT to avoid overhead time for message exchange, the INIT should not send the WIDE DATA TRANSFER REQUEST message and the SYNCHRONOUS DATA TRANSFER REQUEST message or PARALLEL PROTOCOL REQUEST message to the TARG each time the SELECTION phase is executed.

When the requesting synchronous mode transfer/wide mode data transfer by specifying of the CHANGE DEFINITION command (synchronous mode transfer/wide mode data transfer request) is permitted, and the IDD is maintaining the default transfer mode (asynchronous, 8-bit width), if a WIDE DATA TRANSFER REQUEST message is not sent from the INIT, the IDD enters the MESSAGE IN phase immediately after the COMMAND phase and sends the WIDE DATA TRANSFER REQUEST message to the INIT for attempting to set the 16-bit width mode. After establishing the bus width, the IDD sends the SYNCHRONOUS DATA TRANSFER REQUEST message to the INIT and attempts the synchronous mode transfer parameters (REQ/ACK offset = 127, Transfer period = 25 ns).

The IDD maintains data transfer mode settings between itself and each INIT individually. Therefore, an INIT which uses asynchronous mode transfer and an INIT which uses synchronous mode transfer can both coexist on the same SCSI bus. Also, the parameters for synchronous mode transfers decided by the SYNCHRONOUS DATA TRANSFER REQUEST message can differ for each INIT and an INIT which uses the 8-bit width transfer mode can coexist with an INIT which uses the 16-bit width transfer mode.

Note:

When the INIT issues the first command after the TARG's power is switched on, or after a RESET condition occurs, it can send the WIDE DATA TRANSFER REQUEST message and the SYNCHRONOUS DATA TRANSFER REQUEST message. However, when the TARG is set internally on a data transfer mode established previously by a TARGET RESET message issued by another INIT, generally, the INIT is not aware of it. In such case, when requesting synchronous mode/wide mode transfer is permitted by the specification of the CHANGE DEFINITION command (synchronous mode/wide mode transfer request), the TARG (IDD) sends the WIDE DATA TRANSFER REQUEST and SYNCHRONOUS DATA TRANSFER messages to establish the synchronous mode/wide mode transfer again. Thus, the INIT shall respond to these messages for setting necessary parameters again.

See "CHANGE DEFINITION" in Section 3.1.4, SCSI Bus (INFORMATION TRANSFER Phase) in Chapter 1 and SCSI Messages (SYNCHRONOUS DATA TRANSFER REQUEST, WIDE DATA TRANSFER REQUEST, PARALLEL PROTOCOL REQUEST) in Chapter 2 of "SCSI Physical Interface Specifications" for further details.

1.4 Command Queuing Function

The IDD equips a command queuing function. Through queuing of commands, the IDD can receive multiple commands in advance and execute them.

There are two methods used in the queuing function, tagged and untagged. In tagged queuing, the IDD can receive multiple commands from each INIT. In untagged queuing, the IDD can receive a single command from each INIT.

Both queuing methods are possible for the IDD, but an INIT can use only one queuing method at a time. However, if another INIT selects a different method, the IDD controls both methods of command queuing.

1.4.1 Untagged queuing

Using untagged queuing, the IDD can receive a command from an INIT while it is executing processing of a command from another INIT. The IDD can receive one command at a time from each INIT. It is the role of the INIT to confirm that only one command is issued every time.

When the IDD receives a new command from an INIT, if it is processing another command from a different INIT, or if it is currently executing its initial self-diagnosis, that command is queued in the command queue. In this case, the IDD executes disconnect processing after command queuing processing is completed.

After the IDD finishes executing the current processing command, if there is a command in the queue, it fetches that command and executes it. If there are multiple commands in the queue, they are fetched and executed in the order in which they were received.

When a command is in the queued state, if a RESET condition occurs, or if the IDD receives a TARGET RESET message from any INIT, it clears all the commands in the queue. At this time, the IDD generates on UNIT ATTENTION condition for all the INITs.

When an ABORT message is sent from an INIT that has issued a command which is in the queue, if the correct LUN (0) is specified, only the command issued by that INIT is cleared and the other commands in the queue are not effected. If the LUN is not identified, an ABORT message which specifies an illegal LUN (1 to 7) does not effect the commands in the queue.

Untagged queuing exception processing (events and operations executed by the IDD) is shown below.

- **If the TEST UNIT READY, REQUEST SENSE or INQUIRY command is received.**

When one of these commands is received, if there is no link instruction in that command, the IDD executes that command immediately without queuing the command or executing disconnect processing. At this time, there is no effect on the commands from other INITs which are currently being executed, or on the commands in the queue.

If these commands contain link instructions, they are queued.

- **If disconnect processing is impossible.**

If disconnect processing is impossible because the INIT which issued the command does not meet the conditions for permitting a disconnect (see Section 1.3.3), or if the DISCONNECT message is rejected by the INIT even though it meets the conditions for permitting a disconnect, the IDD responds with a BUSY status without queuing the received command except the case described in item 1) in following Note during executing or queuing command already. If this is not the case, the received command is executed immediately.

- **If the IDD is reserved**

If the IDD has been reserved by an INIT using the RESERVE command and receives a TEST UNIT READY command after that, when that command conflicts with the reserved state, it responds with a RESERVATION CONFLICT status. Commands after that are queued, and the reserved state is checked when a command is fetched from the queue. Conflicts with the reserved state are explained in the description of the RESERVE command (Section 3.1.11).

Note:

Through the operation of the command queuing function, except for exceptions described on this page, the IDD does not respond to commands issued by the INIT with a BUSY status. This function is applied under the multi-initiator environment, and overhead for re-issuing commands caused by the BUSY status is unnecessary. Normally, the INIT does not have to be aware of the existence of a queuing function, but it is necessary to exercise caution in the following items when controlling input/output processing.

- 1) When a command is queued, the time from the queuing of the command to its actual execution will vary depending on the commands already in the queue, or on the content of the processing currently being executed. Particularly in cases where the FORMAT UNIT command and START/STOP UNIT command (Immed = 0), and data access commands which specify large processing block counts, are already queued or being executed, the newly queued command will be forced to wait a long time until it is executed.
- 2) In the following cases, a command may not be executed even after it has been queued.

- a) When there is an error in the CDB, the IDD responds with a CHECK CONDITION status at the point when that command is fetched from the queue.
- b) If the IDD is in the not ready state at the point when the queued command is fetched, it responds with a CHECK CONDITION status.
- c) If a UNIT ATTENTION condition is generated before the queued command is fetched, a CHECK CONDITION status may be replied.

1.4.2 Tagged queuing

Through the tagged queuing function, the IDD can receive multiple commands from the same INIT or from different INITs until the command queue is full. The number of commands that it is possible to receive by the IDD is 128 maximum, without relation to the INIT. When the IDD receives a new command, if the command queue is full, it responds to the new command with the TASK SET FULL status.

The IDD manages the command queue, but it is possible for the INIT to add or clear commands from the queue. When adding a command to the queue, it is possible for the INIT to specify the order in which commands should be executed or the command that should be executed next to the IDD.

If the disconnect right is not recognized in the IDENTIFY message of a tagged command, the IDD responds with a BUSY status.

Through the QUEUE TAG message, the INIT can attach a unique tag (ID) to each command. The INIT can set that command's pointer correctly by the tag sent when the IDD reconnects. One INIT can issue multiple commands to the IDD only when the respective commands have unique tags.

If an ORDERED message is used, the IDD executes the other commands not included in the ORDERED message in the order in which they are received. All commands received with a SIMPLE message before commands are received with an ORDERED message are executed before those commands received with the ORDERED message. All commands with SIMPLE messages received after commands received with the ORDERED message are executed after the commands received with the ORDERED message.

Commands received with a HEAD OF QUEUE message are registered at the top of the queue for waiting execution. The IDD does not interrupt the current command execution and executes them after completion of current command execution. When commands with the HEAD OF QUEUE message are received continuously, the IDD first executes the command which was received last.

During the IDD executes or queues a tagged command, the same INIT must issue untagged commands except when the IDD is in the sense hold state.

The IDD handles a series of linked commands as if it were processing a single command and processes the series of commands by the tag received with the first command. A command with a HEAD OF QUEUE received before processing of a series of linked commands is completed is executed by the IDD after all the linked commands in the series have been executed.

The RESERVE, RELEASE and RESERVE EXTENDED commands should be issued together with an ORDERED message. If the HEAD OF QUEUE message is used with these commands, previously issued commands and reserved states may become redundant.

The TEST UNIT READY and INQUIRY commands do not influence the state of the IDD, so they can be issued together with a HEAD OF QUEUE message.

The INIT can specify the following error recovery options by the QErr bit of the control mode parameter (Page A) of the mode select parameters.

When “00” is specified in the QErr bit, the IDD enters any one of a number of sense hold states, and when this state is released, it continues to execute the commands in the queue. The IDD queues any commands received from other INITs while it is in the sense hold state, but during this period, execution of all the commands in the queue is interrupted.

If “01” is specified in the QErr bit, if the IDD enters any one of a number of sense hold states, the queue is cleared after the sense hold state is released. When the queue is cleared through this recovery option, the UNIT ATTENTION condition is generated for all the INITs which had their commands cleared (excluding the INIT that set the sense hold state). The additional sense code Commands cleared by another INIT [=2F-00] is set.

If “10” is specified in the QErr bit, the IDD enters any one of a number of sense hold states. When this sense hold state is released, the queue is cleared of commands from the INIT that entered the sense hold state.

Deferred errors are reported for all commands that have already been completed. Therefore, the queue tag values attached to those commands are not reported.

If a QUEUE TAG message is received by the IDD when tagged commands are prohibited by the DQue bit of the control mode page, the IDD rejects the message with the MESSAGE REJECT message processes the accompanying command as an untagged command.

The ABORT TASK SET, ABORT TASK, TARGET RESET or CLEAR TASK SET message is used to clear some or all of the commands in the queue. See “SCSI Physical Interface Specifications” for details.

If ‘0000’, ‘0001’ is specified in the Queue algorithm modifier of the control mode page, the IDD performs command reordering processing of commands issued with a SIMPLE message. Reordering processing is performed with the objective of reducing total processing time for command processing.

- Conditions for Reordering:

- If a command which is the object of reordering is issued by an INIT that permits reordering with an accompanying SIMPLE message.

- Commands which are Objects of Reordering:

- READ, READ EXTENDED, WRITE, WRITE EXTENDED

If an INIT permits command reordering processing, the IDD changes the processing order of the commands. It is necessary for the INIT to manage concerning the legality of the data, etc.

Section 4.1.7, “Control mode parameters (page code = 0A)” for details of the control mode page.

1.5 UNIT ATTENTION Condition

The UNIT ATTENTION condition is a function used to notify the INIT asynchronously of an event (status change) that has occurred in the TARG or logical unit.

1.5.1 Generation of the UNIT ATTENTION condition

Events which cause a UNIT ATTENTION condition to be generated are one of the following.

- (1) When power on, RESET or TARGET RESET occurs
If the IDD's power is switched on, the IDD enters the RESET condition or is reset by a TARGET RESET message, this UNIT ATTENTION condition is generated for all the INITs, regardless of whether the disk drive is in the ready state or not.

- (2) Mode parameters changed (changed by another INIT)
If the parameters specified in the MODE SELECT or MODE SELECT EXTENDED command are changed by any INIT, a UNIT ATTENTION condition is generated for all the INITs other than the INIT which changed the parameters.

- (3) Commands cleared by another INIT
Commands which are being executed or which are queued are cleared if one of the following events occurs, and this UNIT ATTENTION condition is generated.

- The CLEAR TASK SET message is issued by any INIT.
- Tagged queuing is prohibited by a MODE SELECT or MODE SELECT EXTENDED command (Page A send) from any INIT. (DQue = "1")
- The sense hold state of an INIT is released when "01" is specified in the QErr bit of MODE SELECT parameter page A.

However, the IDD does not enter the UNIT ATTENTION condition hold state for an INIT that issues a CLEAR TASK SET message, an INIT that issues a MODE SELECT or MODE SELECT EXTENDED command, or an INIT that releases the sense hold state.

- (4) Changed operating definition
When the operation mode is changed by the CHANGE DEFINITION command, the UNIT ATTENTION condition is generated for all INITs.

1.5.2 Response and release condition at UNIT ATTENTION condition hold state

A UNIT ATTENTION condition generated by the IDD by the occurrence of the previously mentioned events is held individually for each INIT and it is held until it is released by the INIT it is held for issuing the commands specified below.

When the IDD is holding a UNIT ATTENTION condition, if the IDD receives a command from the INIT that the UNIT ATTENTION condition is held for, it performs one of the following operations depending on the type of command issued.

- (1) Commands other than the INQUIRY and REQUEST SENSE commands
The IDD reports a CHECK CONDITION status to the issue command. The UNIT ATTENTION condition for that INIT is then cleared by the CHECK CONDITION status report. The sense key of the sense data generated at this time is UNIT ATTENTION [=6] and the additional sense codes shown below indicate the event that generated the UNIT ATTENTION condition.

- Power on [=29-01]
- Reset [=29-02]
- TARGET RESET [=29-03]
- Transceiver Mode Changed to SINGLE-ENDED [=29-05]
- Transceiver Mode Changed to LVD [=29-06]
- Mode parameters changed [=2A-01]
- Reservations Preempted [=2A-03]
- Reservations Released [=2A-04]
- Registrations Preempted [=2A-05]
- Commands cleared by another INIT [=2F-00]
- Spindle synchronized [=5C-01]
- Spindle not synchronized [=5C-02]
- Microcode has been changed [=3F-01]
- Changed Operating Definition [=3F-02]
- Device Identifier Changed [=3F-05]

However, if the IDD responds with a BUSY status or TASK SET FULL status due to its not being able to receive the command that was issued, the UNIT ATTENTION condition is not cleared.

The above CHECK CONDITION status response that is the cause of the UNIT ATTENTION condition hold can be prohibited by the specification of the CHANGE DEFINITION command. When the CHECK CONDITION status response is prohibited, the IDD executes the commands it receives normally, except in the case of a RESERVATION CONFLICT status, BUSY status or TASK SET FULL status. In this case, the UNIT ATTENTION condition for the INIT that issued that command is cleared.

See Section 3.1.4 “CHANGE DEFINITION” concerning setting details.

(2) INQUIRY command

The INQUIRY command is executed normally, but the UNIT ATTENTION condition is not cleared.

(3) REQUEST SENSE command

One of the following operations is performed depending on whether or not the IDD is in the sense data hold state (shown in Section 1.6).

a. In the case of a Sense Data Hold state

The IDD executes the REQUEST SENSE command normally and sends the sense data which are being held to the INIT. In this case, the UNIT ATTENTION condition is not cleared.

b. In the case of a State other than a Sense Data Hold state

The IDD executes the REQUEST SENSE command normally and sends the sense data which indicate the UNIT ATTENTION condition and are being held to the INIT. At this time, the UNIT ATTENTION condition for that INIT is cleared.

1.5.3 UNIT ATTENTION condition multiple hold

If any UNIT ATTENTION condition is generated and a new UNIT ATTENTION condition is generated for a different reason before the INIT for which the first UNIT ATTENTION condition was held clears it, those UNIT ATTENTION conditions are held together, and the IDD reports these multiple UNIT ATTENTION conditions in sequence. For example, a “Mode parameters changed,” “Spindle Synchronized” or “Spindle not Synchronized” or other UNIT ATTENTION condition may be reported after the “Power on, RESET or TARGET RESET occurred” UNIT ATTENTION condition is reported.

1.6 Sense Data Hold State

1.6.1 Sense data hold condition

The IDD generates sense data if any of the following conditions occurs and enters the sense data hold state until the conditions for cancellation, described in Section 1.6.2, are established. The sense data which are generated, are held for each individual INIT that issued the applicable command. The sense data hold state is also maintained individually for each INIT which is their object.

- 1) If the IDD reports a CHECK CONDITION status, sense data is generated for the command that was terminated by the CHECK CONDITION status.
- 2) If a fatal error occurs on the SCSI bus and the IDD forcibly enters the BUS FREE phase, sense data is generated for the command that was being executed on the SCSI bus. However, if the LUN cannot be identified by the point when the error occurs, the IDD does not generate sense data.
- 3) Since it is impossible for reconnection processing to be executed without a response from the INIT in the RESELECTION phase, if the IDD clears the command that is necessary for reconnection processing, sense data is generated for that command.

Notes:

1. In the case of 3) above, the IDD does not clearly inform the INIT of the occurrence of an error, but terminates the command abnormally and enters the sense data hold state. If a long period of time passes with no response from the IDD, the INIT that issued the command should issue a REQUEST SENSE command and confirm the content of the error.
2. If the INIT which is the object of holding of sense data cannot be identified because the INIT's SCSI ID was not notified in the SELECTION phase, the INIT enters an unspecified special sense data hold state. In this case, the IDD regards this as the INIT that is the object of holding of the sense data starting a new SELECTION phase in which the INIT's SCSI ID is not notified.

1.6.2 Response and release conditions at sense data hold state

The response of the IDD when it receives a new command while it is in the sense data hold state, and conditions for releasing the sense data hold state are shown below.

- 1) If a command is issued to the logical unit in the sense data hold state by the INIT which is the object of sense data holding.
 - In the case of an untagged command
 - REQUEST SENSE command: The sense data held by the IDD are transferred to the INIT and the sense hold state is released.
 - Other commands: The sense data hold state is released and the command is executed normally if commands issued from the INIT are not queued. If commands issued from the INIT are queued, the commands are treated as overlapping commands.
 - In the case of a tagged command
 - The BUSY status is reported and the sense data hold state is released.
- 2) If a command is issued to the logical unit in the sense data hold state from an INIT which is not the object of sense data holding, the sense data hold state is not released and the command is queued.
- 3) In the following cases, the sense data hold state is released and the sense data being held are lost.
 - The RESET condition occurs on the SCSI bus.
 - A TARGET RESET message is issued by any INIT.
 - An ABORT TASK SET message is issued by an INIT for which sense data held for the logical unit in the sense data hold state.

1.7 Command Processing Exceptions

1.7.1 Overlapping commands

If the following state occurs, the IDD recognizes that overlapping commands have been generated and the command is terminated abnormally.

- 1) During the IDD is executing or queuing an untagged command, the INIT that issued that command before the completion of the command execution issues either an untagged command or a tagged command.
- 2) If the IDD is executing or queuing a tagged command, the INIT that issued that command before the completion of the command execution issues another tagged command with the same tag specified as the previous command or an untagged command.

Normally, completion of a command execution is at the point when the TARG notifies the INIT of the TASK COMPLETE message. Execution of a command can also be terminated by the RESET condition, a TARGET RESET message, CLEAR TASK SET message, ABORT TASK SET message or ABORT TASK message.

The IDD abnormally terminates all the commands (commands being executed or queued) received from an INIT which is overlapping commands and the command that generated the overlap condition by the procedure described below.

- 1) If the command received from the INIT is being executed, the IDD stops execution of the command. If the command is still in the queue and execution has not been started, the IDD clears that command.

- 2) The IDD reports a CHECK CONDITION status for a command that generates an overlap. At this time, the sense data generated by the IDD indicates ABORTED COMMAND [=B]/Overlapped commands attempted [=4E-00], or Tagged Overlapped [=4D-nn] (nn: tag No.).

Notes:

- 1) In order for the INIT to stop processing of a command during a disconnect, it is permitted to send an ABORT TASK message, ABORT TASK SET message, CLEAR TASK SET message or TARGET RESET message with specifying the logical unit (see Section 1.7.6).
- 2) Specification of overlapping commands applies without dependence upon the type of command that is issued second. For example, even if the command issued second is the INQUIRY or REQUEST SENSE command, the IDD reports the CHECK CONDITION status and terminates both the first command and the second command abnormally.

1.7.2 Illegal LUN specification

The logical unit number (LUN) supported by the IDD is LUN = 0 only. If a LUN other than this (1 to 7) is specified, the IDD performs one of the following operations, depending on the type of command issued at that time.

- 1) The INQUIRY command is executed normally even if the LUN specification is illegal. However, byte 0 of the “Standard INQUIRY Data” (“Qualifier” field and “Device Type Code” field) transferred to the INIT for that command indicates X ‘7F.’
- 2) The REQUEST SENSE command is executed normally even if the LUN specification is illegal. However, the sense data transferred to the INIT for that command indicates that the LUN specification is illegal (ILLEGAL REQUEST [=5]/Logical unit not supported [=25-00]).
- 3) If an illegal LUN is specified for a command other than the INQUIRY command or REQUEST SENSE command, that command is terminated abnormally with a CHECK CONDITION status. The sense data generated at this time indicate that the LUN specification is illegal (ILLEGAL REQUEST [=5] /Logical unit not supported [=25-00]).

1.7.3 Reserved operation code

Group 6 and Group 7 commands operation codes (X ‘C0’ to X ‘FF’) are reserved by Fujitsu. When any command is issued which includes these operation codes, the IDD does not always respond with a CHECK CONDITION status (ILLEGAL REQUEST [=5] / Invalid command operation code [=20-00]). The INIT should not issue commands which contain these operation codes.

1.7.4 Command processing in the not ready state

After the IDD’s power is switched on, the initial self-diagnosis is completed normally and the spindle motor reaches the normal rotational speed, “system information,” which includes such information as MODE SELECT parameters and disk media defect information is read from the system space on the disk drive and each type of control information is initialized. When this operation is completed, the IDD is in a state where it can be used (ready state). Furthermore, the not ready state is defined as the IDD being in either of the following states.

- When the spindle motor has not reached the normal rotational speed.
- When reading of system information is not completed, or reading failed.

Also, if initialization of the disk media (formatting) has not been completed normally, it will be impossible to access data on the disk media.

Processing of and response to commands received by the IDD when it is in the not ready state or in the initialization incomplete state are described below. Furthermore, starting control of the spindle motor when the power is switched on can be selected from either or two methods, through the setting terminal (motor start mode) on the IDD, with rotation started at the same time as when the power is switched on or through the START/STOP UNIT command.

(1) General response in not ready state

The IDD reports a CHECK CONDITION status for a command, except in cases where the command is one of the commands in item (2). The sense data generated at this time depends on the state of the IDD, as shown in Table 1.3.

Table 1.3 Sense data in not ready state

IDD State	Sense Key	Additional Sense Code
Spindle motor not rotating at normal speed.	NOT READY [=2]	Logical unit not ready [=04-01]
Reading system information have not completed.	NOT READY [=2]	Logical unit not ready [=04-01]
Reading system information failed.	HARDWARE ERROR [=4]	Logical unit failed self-configuration [=4C-nn]

(2) Commands that can be executed even in the not ready state

If the IDD receives any of the following commands, it executes those commands even if it is in the Not Ready state.

- START/STOP UNIT command
- RESERVE/RESERVE EXTENDED command
- RELEASE/RELEASE EXTENDED command
- WRITE BUFFER command
- READ BUFFER command
- INQUIRY command
- REPORT LUNS command
- REQUEST SENSE command: The REQUEST SENSE command is executed normally. If the IDD is in the sense data hold state, the sense data being held at that time are transferred to the INIT. If not, sense data appropriate to the IDD's state at that time are transferred to the INIT (See Table 1.3).

- REZERO UNIT command: If the spindle motor has reached the normal rotational speed, this command is executed even if reading of system information failed. If the spindle motor has not reached the normal rotating speed, or if reading of system information is still in progress, a CHECK CONDITION status is reported as in item (1).

(3) Operation if formatting is not completed normally

While the FORMAT UNIT command is not being executed after a change in data format related parameters by the MODE SELECT command, if the FORMAT UNIT command is terminated abnormally for any reason (example: power cut off or RESET condition), the data on the disk media cannot be accessed normally. In this case, the IDD reports a CHECK CONDITION status for the command accessing the disk media.

The sense data generated at this time indicate a MEDIUM ERROR [=3] / Medium format corrupted [=31-00] in the case of the former and MEDIUM ERROR [=3] / FORMAT command failed [=31-01]. In either case, the IDD is restored to the ready state by reinitializing the disk media using the FORMAT UNIT command.

1.7.5 Error recovery processing

If an error is detected an recoverable error on the SCSI bus or internally in the IDD, the IDD attempts recovery processing of the detected error during command execution.

The INIT can specify detailed parameters related to error recovery processing and whether or not there is a report for errors which were successfully recovered by using the MODE SELECT or MODE SELECT EXTENDED command. It can also save those parameters in accordance with INIT specifications in the system space on the disk media, and can change them temporarily without saving them. After the power is switched on, or after a reset (RESET condition or TARGET RESET message), the saved parameters are read and the error recovery processing procedures is initialized.

See Section 3.1.5 “MODE SELECT” and Section 3.1.6 “MODE SELECT EXTENDED” for details of the MODE SELECT or MODE SELECT EXTENDED command. See Section 5.3 “Disk Drive Error Recovery Processing” and Chapter 3, “SCSI Bus Error Recovery Processing” of “SCSI Physical Interface Specifications” for details of error recovery processing.

An outline of error recovery processing executed by the IDD is shown below.

(1) Recovery processing for errors on SCSI bus

The IDD performs the error recovery for SCSI bus errors, except for errors detected on DATA phase. However, if some kinds of errors (e.g. a critical error related to SCSI bus protocols) are detected, the IDD may transfer the SCSI bus forcibly to the BUS FREE phase and clear the command that is currently being executed.

Table 1.4 Outline of SCSI Bus Error Recovery Processing

Item	Type of Error	Error Recovery Processing
1	MESSAGE OUT phase parity error	Retry the erroneous phase up to 3 times max / "CHECK CONDTION" Status
2	COMMAND phase parity error	Retry the erroneous phase up to 3 times max / "CHECK CONDTION" Status
3	DATA OUT phase parity error	"CHECK CONDTION" Status
4	Received INITIATOR DETECTED ERROR message.	Retry the erroneous phase up to 3 times max / "CHECK CONDTION" Status
5	Received MESSAGE PARITY ERROR message.	Re-execute RESELECTION phase
6	RESELECTION phase time-out	

(2) Recovery procedures for disk drive errors

The IDD executes error recovery listed in Table 1.5 for an error detected during access to data on the disk. Note that the recovery increases command processing time because of rotation delay for repositioning to the data block on the disk or initialization of the positioning control system.

The INIT can use the MODE SELECT parameter Page 1 (read/write error recovery parameter), Page 7 (verify error recovery parameter), and Page 21 (additional error recovery parameter) to control the retry count. However, use the default value specified by the IDD in general operation.

Table 1.5 Outline of disk drive error recovery processing

Item	Type of Error	Error Recovery Processing
1	Seek Error	Rezero (Return to Zero Cylinder), readjustment of positioning control system, and repositioning to the data block.
2	Uncorrectable Data Error	Reread
3	Correctable Data Error	Correct by ECC.

Note:

The execution start timing of this automatic readjustment operation generally cannot be predicted by the INIT. The automatic readjustment operation is performed when there are no commands being executed or in the queue, but execution of commands issued immediately after the IDD starts the readjustment operation, are forced to wait until the readjustment operation is completed.

1.7.6 Reset processing

The INIT can reset the SCSI bus with following.

- RESET condition
- TARGET RESET message
- CLEAR TASK SET message
- ABORT TASK SET message
- ABORT TASK message

The RESET condition resets all the SCSI devices connected on the same SCSI bus. The IDD is initialized to the same state as when its power is switched on by the RESET condition, with the currently executed command as well as all the commands in the queue cleared.

The TARGET RESET message resets only specific SCSI device (TARG) selected by the INIT, and can initialize that TARG to the same state as when its power is switched on. However in a multi-initiator environment, caution concerning clearing of commands issued by other INITs is necessary.

The CLEAR TASK SET message clears all commands that the IDD is executing or queuing. The previously set environment and conditions, such as MODE SELECT parameters, are not changed.

An INIT which wants to clear only specific commands it has issued itself must use an ABORT TASK SET message or an ABORT TASK message. In this case, the INIT generates an ATTENTION condition at the desired point in time if that command is currently being executed on the SCSI bus, then sends the ABORT TASK SET message to the TARG. Also, if there is a disconnect in effect, after the INIT selects the TARG, an ABORT message, in the case of an untagged command, or an ABORT TASK message, in the case of a tagged command, is sent following an IDENTIFY message which specifies the object logical unit, or the INIT waits until a reconnection request occurs, then sends an ABORT TASK SET message or ABORT TASK message. In the case of an ABORT TASK SET message, only the commands issued previously in the logical unit specified at that time by the INIT that issues the ABORT TASK SET message (currently being executed or queuing) are cleared and there is no influence on the other commands.

When an ABORT TASK message is received, only the command issued to the logical unit specified at that time by the INIT which issued the ABORT TASK message is cleared, and there is no influence on the other commands. No status or TASK COMPLETE message concerning commands cleared in this processing is reported.

In particular, in the case of clearing of a write operation command for writing to the disk media which is currently being executed, the IDD stops processing of that command as shown in Table 1.6. The case of halting an overlapping command that is currently being executed (see Section 1.7.1) is the same. The INIT must determine the complete completion state and if necessary, must execute data recovery processing.

Table 1.6 Reset processing during write

Type of command	Halting process of command execution
WRITE WRITE EXTENDED WRITE AND VERIFY SEND DIAGNOSTIC (Write/Read Test) WRITE LONG WRITE SAME	Data blocks which are currently being written are processed normally, including the ECC portion, and execution of the command is terminated at the point when that processing is completed. Not all the data transferred from the INIT to the IDD will necessarily be written to the disk media.
FORMAT UNIT	At the point when processing of the data block that is currently being written (initialized) is completed, execution of the command is halted. Since the formatting results cannot be guaranteed for the entire disk surface, it is necessary for the INIT to reissue the command.
REASSIGN BLOCKS	At the point when processing of alternate blocks which are currently being assigned is completed, execution of the command is halted. Not all the alternate blocks specified for reassignment processing by the INIT will necessarily have been processed.
MODE SELECT MODE SELECT EXTENDED LOG SENSE (Specifying parameter save)	If a parameter save operation has already started, that command is executed until it is completed. However, since the INIT cannot judge whether the parameters have been saved or not, it is necessary for the INIT to confirm the status by the MODE SENSE command or the LOG SENSE command, or reissue the command.
SYNCHRONIZE CACHE	Not all the data which is the write object will necessarily be written to the disk media.

1.7.7 Fatal hardware errors

(1) Self-diagnostic errors

If a hardware fatal error is detected during the initial self-diagnosis, in off-line self diagnosis or in on-line self-diagnosis (SEND DIAGNOSTIC command), rotation of the spindle motor will be halted.

When in this state, the IDD reports the CHECK CONDITION status for all input/output operation requests except the REQUEST SENSE command. The sense data reported at this time indicate HARDWARE ERROR [=4] / Diagnostic failure on component “nn” [=40-nn]. It is necessary for the INIT either to generate a RESET condition or send a TARGET RESET message and attempt to recover from the error state. For recommended procedures for error recovery methods, see the explanation in Section 5.2 “INIT’s Error Recovery Methods (Recommended).” Furthermore, see Section 6.1.1 “Self-diagnostic Function” in “Product Manual.”

(2) Unrecoverable hardware errors

Limited to cases in which a fatal hardware error occurs during execution of a command, and termination processing such as a CHECK CONDITION status report cannot be executed, the IDD may halt rotation of the spindle motor.

After this state occurs, the IDD reports the CHECK CONDITION status for all input/output operation requests except the REQUEST SENSE command. The sense data reported at this time indicate HARDWARE ERROR [=4] / Internal target failure [=44-nn]. If this state is reported continuously for input/output operation requests, it is necessary for the INIT to generate a RESET condition or send a TARGET RESET message and attempt to recover from the error state. For recommended procedures for error recovery methods by the INIT, see the explanation in Section 5.2 “INIT’s Error Recovery Methods (Recommended).”

1.8 Data Block Addressing

1.8.1 Definition of data space

The IDD manages the data storage area on the disk drive in the following 2 types of data space.

- User space: user data storage area
- System space: IDD exclusive area

Within these 2 areas, the user can clearly access the user space. The data format and defect management methods in this space are the same and it is possible to access this space by logical data block addressing described in Section 1.8.2. System space is accessed by the IDD internally when the power is switched on or during processing of specific commands, but it cannot be accessed directly by the user.

Figure 1.5 shows the data space configuration on the disk drive. The number of cylinders allocated to user space can be referred by the user (MODE SENSE or MODE SENSE EXTENDED command).

A spare sector area (alternate area) for use as alternate sectors for defective sectors is allocated in the user space. The IDD manages defects for each cell, which consists of several cylinders (see Figure 1.5). The user can allocate the number of sectors in the last track of each cell as the alternate area (by the MODE SELECT or MODE SELECT EXTENDED command). Alternate cylinders for the IDD cannot be altered by the user.

Alternate data blocks are allocated in defect sector units for defective sectors on the disk media through internal IDD defect management. Through this defect management, the INIT can access all the logical data blocks in the user space as if they were error free.

For details concerning the data format on the disk media (cylinder configuration, track format and sector format) and details concerning defect management techniques and alternate block allocation techniques, Chapter 3 “Data Format” in the “Product Manual.” For an outline of defect management techniques, see “Disk Media Management” in Chapter 6 of this manual.

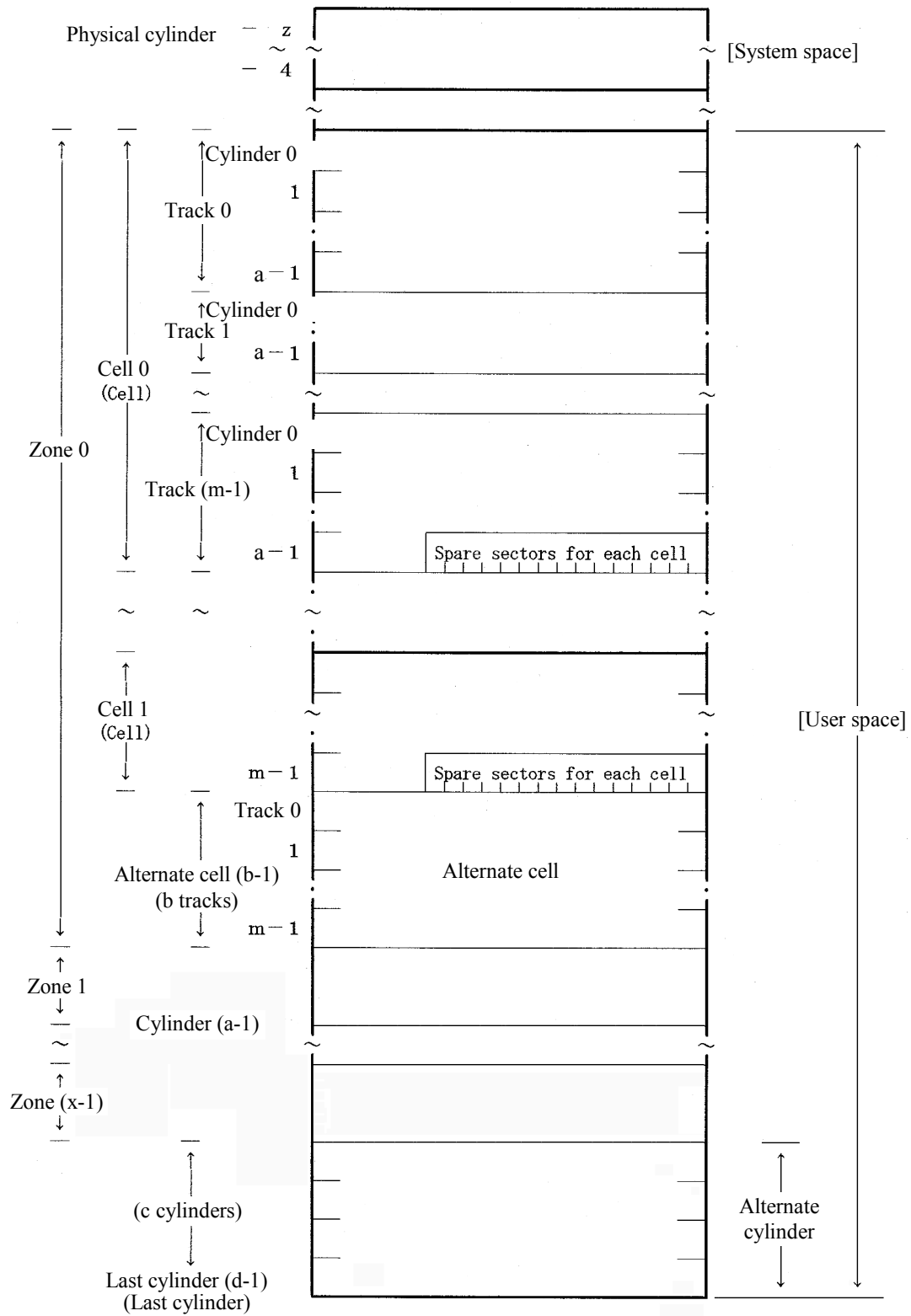

Figure 1.5 Data space configuration

1.8.2 Logical block addressing

The IDD uses logical data block addressing which is not dependent on the disk drive's physical structure as the method of data access on the disk medium. The IDD makes correspondence between each physical sector and each logical data block address during formatting. Access to the data on the disk medium is performed in logical data block units and the INIT specifies the logical data block address that is its object during access.

In logical data block addressing, specifying of a data block address is a function which specifies 2 continuous binary numbers for each drive. Furthermore, the INIT can know the logical data block address range in the user space where specification is possible using the READ CAPACITY command.

(1) User space logical block addresses

The top data block in the user space is made logical data block address "0," then continuous logical data block addresses are allocated to each data block until the last data block in the user space.

The IDD makes cylinder 0, track 0 sector 0 the top logical data block, and allocates subsequent logical data blocks in the order described below to addresses in ascending order.

- 1) Within the same track, logical data blocks are allocated to sector numbers in ascending order.
- 2) Within the same head of the same cell, succeeding logical data blocks are allocated to the sectors in each track according to 1) in the ascending order of cylinder numbers.
- 3) Within the next head of the same cell, succeeding logical data blocks are allocated to the sectors in each track according to 1) and 2) in the ascending order of track numbers.
- 4) On the last track inside the same cell, succeeding logical data blocks are allocated to sectors except for spare sectors according to 1).
- 5) After all the allocation in 1) to 4) is completed within the same cell, succeeding logical data blocks are allocated to the next cell beginning with track 0, according to 1) to 3), and so on to each cell number in ascending order until the last cell in each zone (refer to alternate cell b-1 in Figure 1.5) in the user space, with the exception of alternate cells.

(2) Alternate area

The alternate area in user space (spare sectors within each cell and alternate cells) are excluded from the abovementioned logical data block addresses. Access to allocated sectors as alternate blocks within the alternate area is performed automatically by the IDD's defect management (sector slip processing and alternate block processing), so it is not particularly necessary for the user to access the alternate area. Also, data blocks in the alternate area cannot be clearly specified and accessed directly.

CHAPTER 2 Data Buffer Management

2.1 Data Buffer

2.2 Look-Ahead Cache Feature

2.3 Write Cache

In this chapter, the configuration of the data buffer with which the IDD is equipped, its operation and the operation of the cache feature are described.

2.1 Data Buffer

2.1.1 Data buffer configuration and basic operation

The IDD is equipped with a data buffer, which makes it possible to efficiently execute data transfer operations between INIT (initiator) and a disk drive.

The IDD divides data buffer into 64 Pages, which are minimum allocation size for Cache. Actually two or more Pages are linked and a Cache Segment is constructed per the requested data size from INIT.

Since IDD automatically controls the best suitable Cache Segment, INIT cannot be changed neither the Page size nor the Segment size.

Each data buffer is 2 ports of FIFO (First-In First-Out) ring buffer, with one port allocated for transfers with the disk media and the other port for data transfers with the SCSI bus. Mutual ports operate asynchronously and since it is possible to efficiently absorb variations in data transfer speed between the ports, the INIT can perform data transfer operations with the IDD while being virtually unaware of differences between the SCSI bus data transfer rate and the disk drive data transfer rate.

Even if the data transfer capacity of the SCSI bus (INIT) is lower than the disk drive's data transfer rate, the data buffer can perform data transfers to the system under optimum conditions without using sector interleave. Also, if the data transfer capacity of the SCSI bus (INIT) is higher than the disk drive's data transfer rate, it is possible to minimize the occupancy time on the SCSI bus by accumulating an appropriate amount of data in the data buffer.

Only one cache segment by uniting two or more pages of the divided data buffer is used by one command and the data in the other cache segments are held.

Figure 2.1 shows the data buffer image.

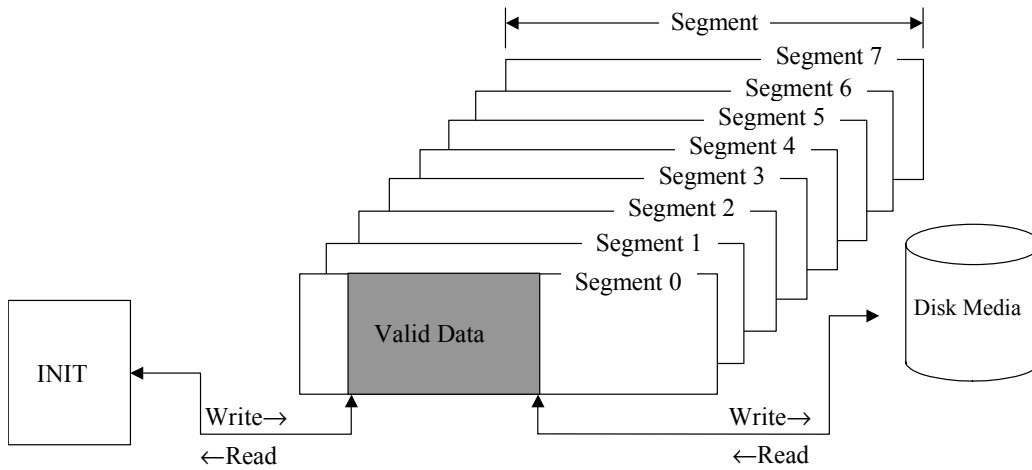

Figure 2.1 Data buffer configuration (in the case of 8 cache segments)

The basic functions and operations of the data buffer in a read operation and a write operation are shown below.

(1) Read operation

Data read from the disk media are temporarily stored in the data buffer. Then, they are transferred to the SCSI bus with the timing specified in the MODE SELECT parameter. The basic read operation procedure is as shown below.

- 1) When the IDD receives a command, normally, it disconnects from the SCSI bus through disconnect processing and locates the data block specified by the command where it is stored on the disk media.
- 2) When the target data block has been located, the IDD reads the data from the disk media to the data buffer. At this time, if a recoverable error is detected, the IDD performs error recovery processing according to the specification in the MODE SELECT parameter or corrects the data in the data buffer.
- 3) When the IDD has read the amount of data specified by the buffer full ratio in the MODE SELECT parameter (see Section 2.1.2) to the data buffer, it performs reconnection processing with the SCSI bus and begins transferring data to the INIT (SCSI bus) from the data buffer while continuing to read subsequent data blocks to the data buffer.
- 4) If the data transfer capacity of the INIT (SCSI bus) is high and the data buffer becomes empty before completing transfer of the number of data blocks specified by the command, the IDD performs disconnect processing at that point. Thereafter, reconnection, data transfer and disconnection (the operations in 3) and 4) above) are repeated until all the data blocks specified in the command have been transferred.
- 5) If the number of blocks specified in the command to be transferred is larger than the capacity of a cache segment and if the data transfer rate of the INIT is lower than the data transfer rate of the disk drive, the empty space in the data buffer disappears from step 3) and the IDD may soon not be able to read data from the disk media (data overrun). In this case, the IDD relocates the block that caused the data overrun after waiting one disk revolution, and continues the reading process.

- 6) When transfer of all the specified data is completed, the IDD reports the status and terminates the command.

Note:

In order to avoid frequent repetition of the disconnect/reconnect processing after data transfer starts on the SCSI bus, and avoid the occurrence of data overruns, it is necessary to set the buffer full ratio (see Section 2.1.2) of the MODE SELECT parameter so the difference in the data transfer rates between the INIT (SCSI bus) and the disk drive is maintained in a good balance.

Figure 2.2 shows an example of the data buffer operating state during a read operation. Details are explained in Section 2.1.2.

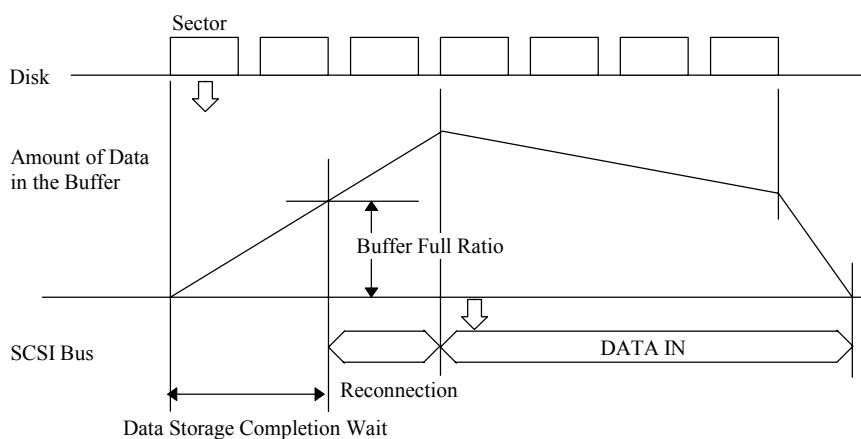

Figure 2.2 Example of data buffer operation during read

(2) Write operation

After data transferred from the INIT are stored temporarily in the data buffer, they are written to the disk media. The basic write operation procedure is as shown below.

- 1) When the IDD receives a command and disconnects, it immediately reconnects and enters the DATA OUT phase and stores data transferred from the INIT to the data buffer (data pre-fetch). At this time, the IDD locates the position of the data block on the disk media specified by the command in parallel.

When storing of all the data specified in the command in the data buffer is completed, or if the empty space in the data buffer is all filled during data storage due to the volume of the specified data, the IDD performs disconnect processing and disconnects from the SCSI bus.

- 2) When locating of the target data block on the disk media is completed, the IDD writes the data in the data buffer to the disk media. If the target data block location operation is completed during the data pre-fetch processing in 1), writing of data to the disk media is performed in parallel with the data pre-fetch to the data buffer.

- 3) If the data transfer rate of the INIT (SCSI bus) is lower than the data transfer rate of the disk drive, since the data pre-fetch of data that are to be written to that data block is not completed, it may not be possible to write the data continuously to the disk (data underrun). In this case, the IDD waits one disk revolution while continuing to pre-fetch data from the INIT, then repositions the block that caused the data underrun and continues the writing of data to the disk.
- 4) After disconnect processing, if all the blocks of data specified in the command have not yet been transferred from the INIT, as writing of data to the disk media progresses, at the point when the empty space in the data buffer reaches the amount specified in the buffer empty ratio in the MODE SELECT parameter, the IDD performs reconnection processing and begins transferring the succeeding data (data pre-fetch).

Writing of data to the disk media is performed in parallel and data transfer with the INIT continues until the empty space in the data buffer is full or until transfer of all the data specified in the command is completed. From then on, disconnection, reconnection and data transfer are repeated until transfer of all the blocks of data specified in the command is completed.

- 5) When writing of all the specified data is completed, the IDD reports the status and terminates the command.

Notes:

1. If the amount of transfer data specified in a command is smaller than the capacity of the cache segment, all the data necessary for execution of the command are pre-fetched in a batch in the processing in 1) above, so the value specified in the buffer empty ratio has not meaning.
2. If the amount of data processed with a single command exceeds the capacity of one cache segment, in order to avoid frequent repetition of disconnect and reconnect processing during command execution, and in order to escape the occurrence of data underrun, it is necessary to set the buffer empty ratio (see Section 2.1.2) of the MODE SELECT parameter so the difference in the data transfer rates between the INIT (SCSI bus) and the disk drive is maintained in a good balance.

Figure 2.3 shows an example of the data buffer operating state during a write operation. Details are explained in section 2.1.2.

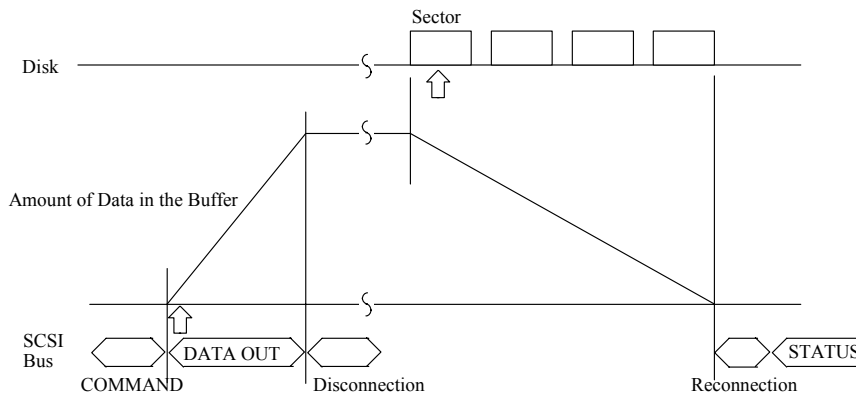

Figure 2.3 Example of data buffer operation during write

2.1.2 Operation mode setting

(1) MODE SELECT parameter

In order to make it possible to control from the INIT the reconnection processing start timing for executing data transfers with the SCSI bus in read and write operations, the IDD is provided with the MODE SELECT parameter (Disconnect/Reconnect Parameter: Page code = 2) shown in Figure 2.4. The user can set the optimum operating state in the system environment as necessary. The MODE SELECT parameter held by the IDD is common to all INITs. Therefore, note that the parameter of each INIT is changed when this parameter is changed. See Section 3.1.5 for details of the MODE SELECT command.

[Disconnect/Reconnect Parameter (Page code = 2)]

Bit	7	6	5	4	3	2	1	0
Byte	0	0	0	0	0	0	1	0
1	X'0E' (Page Length)							
2	Buffer Full Ratio							
	Default Value: X'00' Variable Range: X'00' to X'FF'							
3	Buffer Empty Ratio							
	Default Value: X'00' Variable Range: X'00' to X'FF'							
4	~ (Other parameters) ~							
15								

Figure 2.4 Parameters for controlling reconnection timing

a. Buffer full ratio

This parameter specifies the timing for the IDD to start reconnection to perform data transfer to the INIT in a READ or READ EXTENDED command.

The value specified in this parameter (n) shows the amount of data read to the IDD's data buffer from the disk media as a proportion $[n/256]$ of the total capacity of the data buffer until reconnection processing with the SCSI bus is started. (**Note**)

If it is possible to transfer the amount of data specified in this parameter to the INIT from the data buffer, reconnection processing is executed and transfer of data to the INIT begins. However, if the total amount of transfer data specified in the command does not fill the capacity of the cache segment, the IDD executes reconnection processing and begins transferring data to the INIT when it becomes possible to transfer the amount of data blocks from the data buffer which is equivalent to the proportion of the total volume of transfer data blocks specified in the command that is specified by this parameter.

For example, if a read operation of 16 blocks with a logical data block length of 512 bytes (8 Kbytes) is requested, when the value specified in this parameter is 32, reconnection processing is performed when it becomes possible to transfer 2 blocks of data $[16 \times (32/256)]$, from the data buffer.

b. Buffer empty ratio

This parameter specifies the timing for the IDD to start reconnection when it is requested by the INIT to transfer data in the WRITE, WRITE EXTENDED or WRITE AND VERIFY command. In a write operation, after the IDD receives a command, the IDD begins transferring data (data pre-fetch) while locating the position of the target data blocks on the disk media in parallel. Therefore, if the total number of bytes of data specified in the command is less than the capacity of a cache segment, all the data are pre-fetched in a batch, so the specification in this parameter is not applied.

The value specified in this parameter (n) indicates a proportion of the total data buffer capacity of the IDD when the buffer is empty [n/256]. (**Note**)

While the IDD is writing data to the disk media, it is using the data pre-fetched to the data buffer in order and when the empty space in the data buffer reaches the amount specified in this parameter, it executes reconnection processing, requesting transfer of the succeeding data. However, if the number of data blocks remaining to be transferred according to the command being executed does not reach the amount of data specified in this parameter, the IDD executes reconnection processing at the point when the number of data blocks remaining in the data buffer's empty space reaches the specified number of data blocks and requests transfer of the succeeding data.

Note:

If the value specified for the "buffer full ratio" or the "buffer empty ratio" is not within double the integral boundary of the logical data block length, the IDD rounds up the specified value to the nearest data block boundary. In addition, if zero is specified for any of these parameters, the IDD an appropriate value for the parameter that is determined by IDD.

2.2 Look-Ahead Cache Feature

In order to use the data buffer more effectively and improve the disk drive's effective access speed, the IDD is equipped with a simple cache feature called a "Look-Ahead Cache Feature." The Look-Ahead cache feature is an effective, simple cache function for an INIT which reads data block groups on the disk media sequentially using multiple commands.

2.2.1 Caching operation

When the IDD is executing a READ command or a READ EXTENDED command, it reads the requested data from the disk media and transfers it to the INIT while at the same time reading (looking ahead at) data blocks which are subsequent to the last logical data block specified in that command to the data buffer. Then, when a READ command or READ EXTENDED command issued later specifies any of those Look-Ahead data blocks, the IDD transfers those data directly to the INIT from the data buffer without accessing the disk media. In this way, when continuous logical data block groups are read sequentially by multiple commands, mechanical access operations can be eliminated and effective access time greatly reduced.

An INIT can prohibit the operation of this Look-Ahead cache feature by setting the caching parameter described in section 2.2.2.

(1) Caching object commands

Commands which execute caching operations are the commands shown below:

- READ
- READ EXTENDED

If all the data block groups which are objects of the processing specified in these commands, or a portion of the data blocks, including the top logical data block specified in these commands are relevant data (See item (2)) for caching in the data buffer (if they hit), when the IDD receives a command and performs disconnect processing, it immediately reconnects and sends the data on the data buffer which can be transferred to the INIT. The caching operation can be disabled by the FUA bit of the READ EXTENDED command. If "1" is specified in the FUA bit, the IDD reads data from the disk media.

On the other hand, if the top logical data block specified in a command is not relevant data for caching in the data buffer (if they miss), reading of data is performed from the disk media using the old cache segment.

(2) Data which are objects of caching

Data which exist in the data buffer and which are objects of caching in item (1) (data which are not accessed from the disk media but are transferred to the INIT from the data buffer) are as described below.

- a) Data read by a READ or a READ EXTENDED command and which have been read to the data buffer by Look-Ahead are data which are objects of caching. Depending on the timing for halting Look-Ahead, it is possible that data read by the READ command will be overwritten by Look-Ahead.
- b) Data which have been hit by the READ or READ EXTENDED command and transferred to the INIT once are also objects of caching as long as they are not invalidated.
- c) Data transferred from the INIT and written to the disk media by the WRTE and WRITE EXTENDED command are objects of caching.
- d) Data transferred from the INIT and written to the disk media by the WRITE AND VERIFY command is not the objects of caching.

(3) Disabling caching data

Various data which are objects of caching in the data buffer are disabled in the following cases.

- a) If any of the following commands is issued for the same data block as data which are the object of caching, that data block ceases to be an object of caching.
 - WRITE
 - WRITE AND VERIFY
 - WRITE EXTENDED

b) If any of the following commands is issued, all the data which are objects of caching are disabled.

- CHANGE DEFINITION
- LOG SELECT
- MODE SELECT
- MODE SENSE
- PERSISTENT RSV IN
- READ BUFFER
- READ DEFECT DATA
- READ LONG
- RECEIVE DIAGNOSTIC RESULTS
- REPORT DEV ID
- SEND DIAGNOSTIC
- START/STOP UNIT
- WRITE LONG
- FORMAT UNIT
- LOG SENSE
- MODE SELECT EXTENDED
- MODE SENSE EXTENDED
- PERSISTENT RSV OUT
- READ CAPACITY
- READ DEFECT DATA (12)
- REASSIGN BLOCKS
- RELEASE EXTENDED
- RESERVE EXTENDED
- SET DEVICE IDENTIFIER
- WRITE BUFFER
- WRITE SAME

c) If the data buffer where data which are objects of caching are stored is used by any of the following commands, the data existing in that data buffer which are objects of caching are disabled.

- READ
- READ EXTENDED
- WRITE
- WRITE EXTENDED
- WRITE AND VERIFY
- VERIFY

d) If any of the following events occurs, all the data which are objects of caching are disabled.

- A RESET condition occurs on the SCSI bus.
- A TARGET RESET message is issued by any INIT.

2.2.2 Caching parameters

The IDD supports the MODE SELECT parameters (caching parameters: page code = 8) shown in Figure 2.5 for controlling the cache feature. See Section 4.1 concerning details of the MODE SELECT parameters.

[Caching Parameters (Page Code = 8)]								
Byte \ Bit	7	6	5	4	3	2	1	0
0	0	0	0	0	1	0	0	0
1	X'0A' or X'12' (Page Length)							
2	IC	ABPF	CAP	DISC	SIZE	WCE	MS	RCD
Default	0	0	0	1	0	1	0	0
Variable	1	0	0	0	0	1	0	1
3	X'00' (Reserved)							
4-5	Prefetch-suppressed block count							
Default	X'FFFF'							
Variable	X'0000'							
6-7	Minimum prefetch							
Default	X'0000'							
Variable	X'0000'							
8-9	Maximum prefetch							
Default	X'00xx'							
Variable	X'0000'							
10-11	Maximum prefetch limit block count							
Default	X'FFFF'							
Variable	X'0000'							
12	FSW	LBCSS	DRA	VS	VS	Reserved		
Default	1	0	0	0	0	0	0	0
Variable	0	0	0	0	0	0	0	0
13	Cache segment count							
Default	X'08'							
Variable	X'3F'							
14-15	Cache segment size							
Default	X'0000'							
Variable	X'0000'							
16	X'00' (Reserved)							
17-19	Non cache buffer size							
Default	X'000000'							
Variable	X'000000'							

Remark:

The variable column indicates whether the parameter can be changed or not (if "1", the parameter can be changed).

Figure 2.5 Cache control parameters

2.2.3 Look-Ahead operation, Look-Ahead volume

- 1) Excluding the conditions in 3) and 4) for the amount of data specified as the minimum pre-fetch volume, data are read for look-ahead irrespective of track boundaries or cylinder boundaries. Commands which are already in the queue or commands which are newly received while a look-ahead operation is in progress, are executed after the look-ahead operation is completed. However, if the new command is a READ or READ EXTENDED command, and it is a command in which the first specified logical data block is a sequential access data block, the command is executed without the look-ahead operation being halted. When a newly received command is a command which is not the object of caching, that command is executed immediately in parallel with a look-ahead operation.

Also, in the case of a command which disables all data which are objects of caching (see Section 2.2.1 (3)), the look-ahead operation is halted and that command is executed immediately.

- 2) When commands exist in the queue, the look-ahead operation is halted at the point when reading of the specified amount of data at the minimum pre-fetch volume is completed, then execution of the new command starts. When there are no commands that need to be newly executed, the data look-ahead operation is continued, even after the volume of data specified as the minimum amount of pre-fetch data have been read, until one of the following conditions, 1), 3) or 4), occurs.
 - When "1" is specified in the DISC bit, if look-ahead of data equal in volume to a cache segment is completed.
 - When "0" is specified in the DISC bit, if look-ahead of all the data is completed up to the track boundary or the cylinder boundary.

The IDD does not support this function.

- 3) During a data look-ahead operation, when any error occurs, the data look-ahead operation is terminated at that point (retry is not executed).
- 4) When a RESET condition occurs on the SCSI bus, or when any INIT issues a TARGET RESET message, the look-ahead operation is terminated at that point and all the look-ahead data stored in the data buffer are invalidated.
- 5) During a look-ahead operation, if "sector slip processing" is applied, or defective sectors exist in the same cylinder to which "alternate processing" is applicable, the look-ahead operation is continued without interruption.

2.3 Write Cache

The IDD is equipped with a write cache function in order to reduce the INIT's command processing time. If that operation is permitted by the MODE SELECT command (caching parameters: Page code = 8, WCE bit), at the point when the IDD completes the transfer of all data specified in the WRITE or WRITE EXTENDED command, it reports the GOOD status and terminates the command.

Note:

If the write cache function is permitted, data transferred from the INIT by a WRITE or WRITE EXTENDED command are written to the disk media after the GOOD status is reported, so when an unrecoverable write error is detected in that write operation, sense data is generated. When those sense data is being held, the IDD ordinarily responds to the command that is executed next by a "CHECK" status (deferred error), notifying the INIT that sense data is being held. However, ordinarily, it is troublesome for the INIT to retry when there is an unrecoverable error in a write cache operation, so adequate caution should be exercised when using this function.

This page is intentionally left blank.

CHAPTER 3 Command Specifications

- | | |
|------------|---|
| 3.1 | Control/Sense Commands |
| 3.2 | Data Access Commands |
| 3.3 | Format Commands |
| 3.4 | Maintenance, Diagnostic Commands |

This chapter describes detailed specifications of the SCSI commands which the IDD is equipped with and how to use them.

3.1 Control/Sense Commands

3.1.1 TEST UNIT READY (00)

Bit Byte	7	6	5	4	3	2	1	0
0	X'00'							
1	LUN			0	0	0	0	0
2	0	0	0	0	0	0	0	0
3	0	0	0	0	0	0	0	0
4	0	0	0	0	0	0	0	0
5	0	0	0	0	0	0	0	Link

This command checks the status of the disk drive. This command is executed immediately without queueing in a system which issues only commands with no tags or links.

If the IDD is in the ready state and it is possible for it to be used by the application client which issues this command, a GOOD status is reported for this command.

If the IDD is not in the ready state, it reports a CHECK CONDITION status for this command. The sense data generated at this time indicate the IDD's state at this time.

3.1.2 INQUIRY (12)

Bit Byte	7	6	5	4	3	2	1	0
0	X'12'							
1	LUN			0	0	0	CmdDt	EVPD
2	Page Code/Operation Cpde							
3	0	0	0	0	0	0	0	0
4	Transfer Byte Length							
5	0	0	0	0	0	0	0	Link

This command transfers the information showing the IDD's characteristics (INQUIRY data) to the application client. This command is executed immediately without queuing in a system which issues only commands with no tags or links.

This command is executed normally even in cases where the UNIT ATTENTION condition is held, and the UNIT ATTENTION condition is not cleared. This command is also executed normally when the disk drive is not in the ready state or even when an illegal logical unit number (LUN) is specified.

A CHECK CONDITION status is reported for this command and it is terminated abnormally only in the case that one of the following conditions is detected.

- There is an error in the specifications other than the LUN field of the CDB.
- It is impossible to send INQUIRY data because of an IDD hardware error.
- An unrecoverable error was detected on the SCSI bus.
- An error detected during command execution was recovered in the IDD's error recovery processing (Retry), but the mode which reports "RECOVERED ERROR" is specified in the MODE SELECT parameter.
- Applicability to overlapping command exception conditions (See Section 1.7.1.)

The functions which can be specified in this command's CDB and the contents of information transferred to the application client from the IDD differ depending on the specifications in the CHANGE DEFINITION command. Furthermore, see Section 3.1.4, "CHANGE DEFINITION (40)" concerning the CHANGE DEFINITION command.

If bytes 1, the "EVPD (enable vital product data)" bits, the "CmdDt (Command Support Data)" bits, and byte 2, the "Page code" field in the CDB are enabled only in the case that transfer of the SCSI-2/SCSI-3 mode's INQUIRY data is specified. In the case of the SCSI-1/CCS mode, zero must be set in these bits and in this field. And if both the "EVPD" and "CmdDt" bits are one, this command is terminated by a CHECK CONDITION status (ILLEGAL REQUEST [=5] / Invalid Field in CDB [=24-00]).

- (1) EVPD (Enable Vital Product Data)
 - a) If the specification in this bit is zero, the IDD transfers the standard INQUIRY data or the command supported data, mentioned later, to the application client.
 - b) If the specification in this bit is one, product information called VPD (vital product data) is transferred to the application client.
- (2) CmdDt (Command Supported Data)
 - a) If the specification in this bit is zero, the IDD transfers the standard INQUIRY data, mentioned later, to the application client.
 - b) If the specification in this bit is one, the IDD transfers the command supported data, mentioned later, to the application client.
- (3) Page code/Operation code
 - a) When the "EVPD" bit is one, this field specifies that the IDD transfers the kind of the VPD information.
 - b) If the "EVPD" bit is zero and the "CmdDt" bit is one, this field specifies the operation code (CDB byte 0) of commands generated command supported data.
- (4) Transfer Byte Length

Byte 4 of the CDB, the "Transfer Byte Length" field, shows the number of bytes of standard INQUIRY data or VPD information that the application client can receive by this command. The IDD transfers data with the byte length specified in the "Transfer Byte Length" field, or the byte length in the standard INQUIRY data or VPD information which it is holding, whichever has the smallest number of bytes, to the application client. When zero is specified in the "Transfer Byte Length" field, this command is normally terminated without anything being transferred.
- (5) Standard INQUIRY data

Figure 3.1 shows the format and contents of the standard INQUIRY data transferred to the INIT by this command if "0" is specified in the "EVPD" and the "CmdDt" bit.

Byte	Bit	7	6	5	4	3	2	1	0	SCSI mode									
0		Qualifier (0, 0, 0) or (0, 1, 1)			Device Type Code (0, 0, 0, 0, 0) or (1, 1, 1, 1, 1)						----								
		1	RMB	Reserved								SCSI-1/CCS							
0	0		0	0	0	0	0	0	0	SCSI-3									
	1	RMB	Device Type Code								SCSI-2								
		0	0	0	0	0	0	0	0	0									
2	Version										----								
	X' 01' (SCSI-1)										SCSI-1/CCS								
	X' 02' (SCSI-2)										SCSI-2								
	X' 03' (SPC)										SCSI-3								
3	AENC	TrmIOP					Response Data Format				----								
	0	0	0	0	0	0	0	0	1	SCSI-1/CCS									
	0	0	0	0	0	0	0	1	0	SCSI-2									
	AERC	Obsolete	NORMACA	HISUP	Response Data Format						----								
0	0	0	0/1	0	0	0	1	0	SCSI-3										
4	Additional Data Length																		
	0	1	0	1	1	0	1	1											
5	0	0	0	0	0	0	0	0	0	CCS/SCSI-2									
	SCCS	Reserved									SCSI-3								
	0	0	0	0	0	0	0	0	0										
6	0	0	0	0	0	0	0	0	0	SCSI-1/CCS									
	(Reserved)		Port	DualP		ACKB REQ	Addr32	Addr16											
	0	0	0/1	0	0	0	0	0/1											
	BQue	EncServ	VS	MultiP	MCHNGR	Obsolete		Addr16											
	0	0	0	0	0	0	0	0	0/1	SCSI-3									
7	0	0	0	0	0	0	0	0	0	SCSI-1/CCS									
	RelAdr	WBus32	WBus16	Sync	Linked	TTD	CmdQue	SftRe											
	0	0	0/1	1	1	0	1	0	SCSI-2										
	RelAdr	Obsolete	Wbus16	Sync	Linked	TranDis	CmdQue	VS											
0	0	0/1	1	1	0	1	0	SCSI-3											
8	9	FUJITSU (Vendor ID: ASCII)								----									
15																			
16										17	(Product ID: ASCII)								----
31																			
32	33	Microcode Version No. (ASCII)																	
34										35	(Product Revision: ASCII)								----
47																			
36	37	Device Serial No. (ASCII)								----									
47																			
48-55	X'00' (Vendor Specific)																		
56	X'00' (Reserved)										CCS/SCSI-2								
	Reserved					CLOCKING		QAS	IUS										
	0	0	0	0	0	0/1	0/1	0/1	0/1	SCSI-3									
57	X'00' (Reserved)																		
56-73	X'00' (Reserved)										CCS/SCSI-2								
	Version Descriptor										SCSI-3								
74-95	X'00' (Reserved)																		

Figure 3.1 Standard INQUIRY data

a. Qualifier field

(0,0,0): The specified logical unit shows the type of input/output device shown in the "Device Type Code" field. Even if this code is reported, it does not mean that that logical unit is in the ready state.

(0,0,1): The specified logical unit shows the type of input/output device shown in the "Device Type Code" field, but it shows that an actual input/output device is not connected to that logical unit. The IDD does not report this code.

(0,1,1): Shows that the specified logical unit is not supported. When this code is reported, it X '1F' is shown in the "Device Type Code" field.

b. Device type code

(0,0,0,0,0): Direct access device

(1,1,1,1,1): Undefined device

When LUN=0 is specified, the IDD reports "(0,0,0,0,0) : direct access device" as the device type code. At this time, the "Qualifier" field is "(0,0,0)." Therefore, byte 0 indicates X '00.' On the other hand, when a LUN other than "0" is specified, the IDD reports "(1,1,1,1,1) : undefined device" as the device type code. At this time, the "Qualifier" field is "(0,1,1)." Therefore, byte 0 indicates X '7F.'

c. RMB bit

When this bit is "1," it indicates that the storage media is a removable disk device. The IDD is a fixed disk device, so this bit is always reported as "0."

d. Version

The VERSION field indicates the implemented version of this standard and is defined below.

Code	Description
X'01'	ANSI X3.131: 1986 (SCSI-1)
X'02'	ANSI X3.131: 1994 (SCSI-2)
X'03'	ANSI X3.301: 1997 (SPC Rev.11)
X'04'	T10/1236-D (SPC-2)

e. Response data format field

This field shows the code which shows the standard INQUIRY data format. The definition of the code is (0,0,0,1) for SCSI-1/CCS mode or (0,0,1,0) for SCSI-2 or SCSI-3 mode.

f. Additional data length

This field shows the length of the INQUIRY data (byte length) after byte 5. This value shows the length in the INQUIRY data held by the IDD without relation to the specification in the transfer byte length field in the CDB, and is always X'5B' (total data length = 96 bytes).

g. Supported functions

The bit positions shown below are valid only when the CHANGE DEFINITION command is set so that the SCSI-2 or SCSI-3 mode INQUIRY data are transferred, and the functions which the IDD supports are shown in the bit correspondence.

"1" indicates that that function is supported and "0" indicates that that function is not supported. When the CHANGE DEFINITION command is not set so that SCSI-2 mode INQUIRY data are transferred, "0" is displayed in all these bit positions.

- SCSI-3 mode
 - [Byte 3]
 - AERC (Asynchronous event reporting capability):
Asynchronous condition notify function [0]
 - NORMACA (Normal ACA supported):
ACA support [0]
 - HISUP (Hierarchical support):
Defined the hierarchical addressing model to assign LUN [0/1]
 - [Byte 5]
 - SCCS (SCC support):
Embedded storage array controller equipment [0]
 - [Byte 6]
 - BQue (Basic queuing):
Combination with CMDQUE [0]
 - EncServ (Enclosure service):
Enclosure service [0]
 - MultiP (Multi port):
Supported multi-port [0]
 - MChngr (Medium changer):
Medium Changer [0]
 - Addr16 (Wide SCSI address 16):
16 bit SCSI addressing [0/1]
 - [Byte 7]
 - RelAdr (Relative addressing):
Relative logical block addressing [0]
 - WBus16 (16-bit wide data transfer):
Data transfer on a 2-byte bus [0/1]
 - Sync (Synchronous data transfer):
Data transfer on the synchronous mode [1]
 - Linked (Linked command):
Command link function [1]
 - TranDis (Transfer disable):
Continue task and target transfer disable message [0]
 - CmdQue (Command queuing):
Command queuing function [1]

Bque	CmdQue	Description
0	0	No command queuing of any kink supported
0	1	Command queuing with all types of task tags supported
1	0	Basic task set model supported
1	1	Illegal combination of BQue and CmdQue bits

- VS (Vendor specific):
Not defined [0]

- SCSI-2 mode
 - [Byte 3]
 - AENC (Asynchronous event notification capability):
 - Asynchronous condition notify function [0]
 - TrmIOP (Terminate I/O process):
 - TERMINATE I/O PROCESS message [0]
 - [Byte 6]
 - DualP (Dual port):
 - Dual port function [0]
 - Port:
 - Connection port, '0'= connect to port A [0]
 - '1'= connect to port B
 - ACKBREQB (ACKB/REQB):
 - Use the ACKB and REQB signals with the B cable or the Q cable [0]
 - Addr32 (Wide SCSI address 32):
 - 32 bit SCSI addressing [0]
 - Addr16 (Wide SCSI address 16):
 - 16 bit SCSI addressing [0/1]
 - [Byte 7]
 - RelAdr (Relative addressing):
 - Relative logical block addressing [0]
 - WBus32 (32-bit wide data transfer):
 - Data transfer on a 4-byte bus [0]
 - WBus16 (16-bit wide data transfer):
 - Data transfer on a 2-byte bus [0/1]
 - Sync (Synchronous data transfer)
 - Data transfer in the synchronous mode [1]
 - Linked (Linked command):
 - Command link function [1]
 - TTD (Target transfer disable):
 - Target transfer disable message [0]
 - CmdQue (Command queuing):
 - Tagged command queuing feature [1]
 - SftRe (Soft Reset):
 - Soft reset condition [0]

h. Vendor ID field

This field indicates the name of the product's supplier in left-justified ASCII code, and always indicates FUJITSU. The unused right end is space for the ASCII code.

i. Product ID field

The product's model name is displayed in left-justified ASCII code in this field.

j. Product Revision field

The IDD's microcode version number is displayed in ASCII code in this field.

k. Device Serial Number field

The value following byte 4 of the device serial number in the VPD information is indicated in this field. Higher order digits which do not contain valid numbers are filled with ASCII code spaces (X'20').

l. Clocking field

This field indicates the code which shows the clocking method. The definition of the code is as shown below.

"Clocking" Bit 3	2	Description
0	0	Indicates the device server supports only ST
0	1	Indicates the device server supports only DT
1	0	Reserved
1	1	Indicates the device server supports ST and DT

m. QAS (Quick Arbitrate Supported) bit

This bit of one indicates that the device server supports the quick arbitrate feature. A value of zero indicates that the device server does not support the quick arbitrate feature.

n. IUS (Information unit supported) bit

This bit of one indicates that the device server supports information units. A value of zero indicates that the device server does not support information units.

o. Version Descriptor field

This field is provided for identifying up to eight standards to which the Device claims conformance. The IDD shall be indicated as shown below.

BYTE	Code	Description
58 to 59	X'00', X'40'	SAM2
60 to 61	X'0B', X'54'	SPI4 T10/1356 rev07
62 to 63	X'01', X'3C'	SPC ANSI X3.301: 1997
64 to 65	X'01', X'9B'	SBC T10/0996 rev08C
66 to 67	X'00', X'00'	-
68 to 69	X'00', X'00'	-
70 to 71	X'00', X'00'	-
72 to 73	X'00', X'00'	-

(6) Command Support Data

Figure 3.2 shows the format and contents of the command support data transferred to the INIT by this command if "0" is specified in the "EVDP" bit and "1" is specified in the "CmdDt" bit.

Byte \ Bit	7	6	5	4	3	2	1	0
0	Qualifier			Device Type Code				
1	0	0	0	0	0	Support		
2	Version							
3	X'00' (Reserved)							
4	X'00' (Reserved)							
5	CDB Size (m-5)							
6	CDB Usage Data							
m								

Figure 3.2 Command support data

a. Qualifier, Device Type Code, Version

These fields are the same as those in the previously mentioned standard INQUIRY data.

b. Support

This field indicates the value defined below.

"Support" Bit	2	1	0	Description
	0	0	0	Data about the requested SCSI operation code is not currently available.
	0	0	1	The device server does not support the tested SCSI operation code. All data after byte 1 is undefined.
	0	1	0	Reserved
	0	1	1	The device server supports the tested SCSI operation code in conformance with an SCSI standard.
	1	0	0	Vendor-specific (undefined)
	1	0	1	The device server supports the tested SCSI operation code in a vendor-specific manner.
	1	1	0	Vendor-specific (undefined)
	1	1	1	Reserved

If the "Support" field contains "000b", all data after byte 1 is not valid. One possible reason for "support" being "000b" is the device server's inability to retrieve information stored on the media. When this is the case, a subsequent request for command support data may be successful.

c. CDB size

This field contains the number of bytes in the CDB for the operation code being queried, and the size of the "CDB Usage Data" field in the return data.

d. CDB usage data

This field contains information about the CDB for the operation code being queried. The first byte of the "CDB usage data" contains the operation code for the operation being queried. All bytes except the first byte of the "CDB usage data" contains a usage map for bits in the CDB for the operation code being queried.

The bits in the "Usage map" have a one-for-one correspondence to the CDB for the operation code being queried. If the device server evaluates a bit as all or part of a field in the CDB for the operation code being queried, the usage map contains a one in the corresponding bit position. If the device server ignores or treats as reserved a bit in the CDB for the operation code being queried, the usage map contains a zero in the corresponding bit position. The usage map bits for a given CDB field all have the same value.

Thus, the CDB usage bit map for Inquiry command for a device server that implements command support data but not vital product data is: 12h, 02h, FFh, 00h, FFh, 01h.

(7) VPD information

When "1" is specified in the "EVPD" bits of the CDB, the VPD information described below is transferred to the INIT by this command. The INIT specifies the type of VPD information required in the "Page code" field of the CDB. The type of VPD information supported by the IDD and its page code number are as shown below.

Page Code Page (Hex)	Function
00	Page code list of supported VPD information
80	Device serial number
C0	Operation mode

Furthermore, if page codes other than those shown above (VPD information that is not supported by the IDD) are specified in the CDB, that command is terminated with a CHECK CONDITION status (ILLEGAL REQUEST [=5] / Invalid field in CBD [=24-00]).

The format and contents of each type of VPD information are shown below.

a. Page code list

This VPD information reports the page code list of VPD information supported by the IDD. The format of this VPD information is shown in Figure 3.3.

Byte \ Bit	7	6	5	4	3	2	1	0
0	Qualifier			Device Type Code				
1	X'00' (Page Code)							
2	X'00'							
3	X'03' (Page Length)							
4	X'00' (Page Code List)							
5	X'80' (Device Serial No.)							
6	X'C0' (Operation Mode)							

Figure 3.3 VPD information: VPD identifier list

The values indicated in the "Qualifier" and "Device Type Code" fields in byte 0 are the same as those in the previously mentioned standard INQUIRY data. The "Page code" field in byte 1 indicates the page code (X '00') of this VPD information itself. Also, the "Page length" field in byte 3 indicates the length (byte length) after byte 4. This value has no relationship to the specification in the "Transfer Byte Length" in the CDB, but indicates the length of this VPD information and is always X '03' (Total data length = 7 bytes).

Byte 4 and subsequent bytes list all the VPD information page codes supported by the IDD, with the VPD page code indicated in ascending order in each byte.

b. Device serial No.

This VPD information reports the device serial number of the IDD. The format of this VPD information is shown in Figure 3.4.

Byte \ Bit	7	6	5	4	3	2	1	0
0	Qualifier			Device Type Code				
1	X'80' (Page Code)							
2	X'00'							
3	X'0C' (Page Length)							
4								
5								
~								
~								
15								

Figure 3.4 VPD information: device serial No.

The values indicated in the "Qualifier" and "Device Type Code" fields in byte 0 are the same as those in the previously mentioned standard INQUIRY data. The "Page code" field in byte 1 indicates the page code (X '80') of this VPD information itself. Also, the "Page length" field in byte 3 indicates the length (byte length) after byte 4. This value has no relationship to the specification in the "Transfer Byte Length" in the CDB, but indicates the length of this VPD information and is always X '0C' (Total data length = 16 bytes).

Bytes 4 to 15 indicate the IDD's device serial number in right-justified decimal (ASCII code).

c. Operation mode

This VPD information reports the IDD's current operation mode. The format of this VPD information is shown in Figure 3.5.

Byte \ Bit	7	6	5	4	3	2	1	0
0	Qualifier			Device Type Code				
1	X'C0' (Page Code)							
2	X'00'							
3	X'04' (Page Length)							
4	0	0	0	WDTR	UNTAIN	SDTR	RSRTY	0
5	PHSCRC	AGD	ACE	0	0	0	RTD	
6	X'xx' (Spindle Motor Start Delay Timing)							
7	X'00' (Reserved)							

Figure 3.5 VPD information: operation mode

The values indicated in the "Qualifier" and "Device Type Code" fields in byte 0 are the same as those in the previously mentioned standard INQUIRY data. The "Page code" field in byte 1 indicates the page code (X 'C0') of this VPD information itself. Also, the "Page length" field in byte 3 indicates the length (byte length) after byte 4. This value has no relationship to the specification in the "Transfer Byte Length" in the CDB, but indicates the length of this VPD information and is always X '04' (Total data length = 8 bytes).

Byte 4 and subsequent bytes list all the VPD information page modes currently set in the IDD. This operation mode setting is performed by the CHANGE DEFINITION command, described in Section 3.1.4, and Section 3.1.4 shows concerning a detailed definition of each bit.

3.1.3 READ CAPACITY (25)

Byte \ Bit	7	6	5	4	3	2	1	0
0	X'25'							
1	LUN			0	0	0	0	0
2	Logical Block Address (MSB)							
3	Logical Block Address							
4	Logical Block Address							
5	Logical Block Address (LSB)							
6	0	0	0	0	0	0	0	0
7	0	0	0	0	0	0	0	0
8	0	0	0	0	0	0	0	PMI
9	0	0	0	0	0	0	0	Link

This command transfers information related to the disk drive's capacity and the data block size to the INIT.

When bit 0 "PMI (partial medium indicator)" of CDB byte 8 is "0," the logical block address and block length (byte length) of the final data block which is accessible in the disk drive (user space) are transferred to the INIT. At this time, the "Logical Block address" field in the CDB must specify zero.

When the "PMI" bit is "1," the logical block address and block length (byte length) of data blocks which satisfy either of the following conditions is transferred to the INIT.

- The data block on the track where the specified block exists, which is just before the block where the first alternate sector processing (not including defective block sector slip processing) is implemented. However, when alternate sector processing is being implemented in the specified block, the data block specified in the CDB.
- When no alternate sector processed data block exists in the track where the specified block exists, the last data block in that track.

By using this command with the "PMI" bit specified as "1", the INIT can search for usable data space continuously without being interrupted by data transfers for alternate sector processing or switching of track.

The format of the data transferred to the INIT by this command is shown in Figure 3.6.

Byte \ Bit	7	6	5	4	3	2	1	0
0	Logical Block Address (MSB)							
1	Logical Block Address							
2	Logical Block Address							
3	Logical Block Address (LSB)							
4	Block Length (MSB)							
5	Block Length							
6	Block Length							
7	Block Length (LSB)							

Figure 3.6 READ CAPACITY data

3.1.4 CHANGE DEFINITION (40)

Byte \ Bit	7	6	5	4	3	2	1	0
0	X'40'							
1	LUN			0	0	0	0	0
2	0	0	0	0	0	0	0	Save
3	0	SCSI Level						
4	0	0	0	0	0	0	0	0
5	0	0	0	0	0	0	0	0
6	0	0	0	0	0	0	0	0
7	0	0	0	0	0	0	0	0
8	Parameter List Length							
9	0	0	0	0	0	0	0	Link

This command changes the IDD's SCSI level and the operation mode.

The INIT can know the SCSI level and operation mode that the IDD is currently using by the INQUIRY command (Standard Inquiry Data and VPD Information - Operation Mode Page: Page code X 'C0').

If the "Save" bit of CDB byte 2 specifies "1," the IDD saves the SCSI level and operation mode specified in this command in the Boot-ROM (Flash ROM) when the command is executed.

If this bit specifies "0," the changes are not saved.

This command specifies a different SCSI level in the "SCSI level" field in SCB byte 3. The SCSI level is indicated by 1 byte of code as shown in the following table. If a code other than the following codes is specified, the command is terminated by a CHECK CONDITION status (ILLEGAL REQUEST [=5] / Invalid field in CDB [=24-00]) and the SCSI level and operation mode are not changed.

Operation Code (HEX)	SCSI Level
X'00'	Not Change
X'01'	SCSI-1 (Same as CCS)
X'02'	CCS (Same as SCSI-1)
X'03'	SCSI-2
*1 X'04'	SCSI-3

*1 Set at shipping time.

If zero is specified in the "SCSI Level" field, the IDD operates at the current SCSI level without changing the SCSI level. However, if the correct operation mode parameter (described later) is transferred at the same time, the IDD changes its operation mode.

The total byte length of the operation mode parameter transferred by the INIT with this command is specified in the "Parameter List Length" field in CDB byte 8.

If zero is specified in the "Parameter List Length" field, the command is terminated normally with only the SCSI level being changed.

When changing the operation mode, the "Parameter List Length" field must always be specified by the length (=8) defined by the operation parameter, described later. If a value other than the defined length in the "Parameter Byte Length" field is specified, this command is terminated with a CHECK CONDITION status (ILLEGAL REQUEST [=5] / Invalid field in CDB [=24-00]) and the SCSI level and operation mode are not changed.

If the IDD's operation mode is changed by this command, a UNIT ATTENTION condition (UNIT ATTENTION [=6] / INQUIRY Data has changed [=3F-00]) is generated for all the INITs except the INIT that issued this command.

The format for the operation mode parameter transferred by this command from the INIT to the IDD is shown below. If the operation mode parameter is transferred in a format other than that shown below, this command is terminated with a CHECK CONDITION status (ILLEGAL REQUEST [=5] / Invalid field in parameter list [=26-00]) and the SCSI level and operation mode are not changed.

Byte \ Bit	7	6	5	4	3	2	1	0	
0	X'00'								Header
1	X'00'								
2	X'00'								
3	X'04' (Parameter Length)								
4	0	0	0	WDTR	UNTAIN	SDTR	RSRTY	0	Parameter List
5	PHSCRC	AGD	ACE	0	0	0	RTD		
6	X'xx' (Spindle Motor Start Delay Time)								
7	X'00' (Reserved)								

Figure 3.7 CHANGE DEFINITION command: operation mode parameter

The operation mode parameter is configured from a 4-byte parameter list following a 4-byte header.

(1) Header

a) Bytes 0 to 2

X '00' must be specified in this field.

b) Parameter length

The parameter list length in byte 4 and subsequent bytes which follows the header must be specified in this field. The parameter list length supported by the IDD is X '04' and the INIT must not specify a value other than X '04' in this field. If a value other than X '04' is specified, this command is terminated with a CHECK CONDITION status (ILLEGAL REQUEST [=5] / Invalid field in parameter list [=26-00]) and the operation mode are not changed.

(2) Parameter list

a) WDTR (wide data transfer request: Effective for 16-bit SCSI devices only.)

This specifies whether or not a wide mode data transfer request from the IDD is permitted. If this bit is set to 1, also set SDTR to 1. If only this bit is set but SDTR is not set, error code 5-26-00 is returned.

"1" (Permitted): After the power is switched on, after a RESET condition occurs or when the first command is received following reception of a BUS DEVICE RESET message, if a WIDE DATA TRANSFER REQUEST (WDTR) message is not sent by the INIT, the IDD sends the WDTR message and attempts to establish wide mode data transfer.

"0"* (Prohibited): If it is necessary to establish wide mode data transfer, the IDD does not send the WDTR message. However, if the INIT sends the WDTR message, the IDD responds normally.

* Set at shipping time

b) UNTATN (UNIT ATTENTION report mode)

This specifies the response method to commands received from the INIT when the IDD is holding a UNIT ATTENTION condition:

"1"* (Report): The IDD reports a CHECK CONDITION status (Standard SCSI specification) in response to commands other than INQUIRY and REQUEST SENSE.

"0" (No Report): The IDD terminates all commands that are received normally. (A CHECK CONDITION status which causes a UNIT ATTENTION condition is not reported.)

* Set at shipping time

c) SDTR (synchronous data transfer request)

Specifies whether or not it is permitted for the TARG to request a synchronous mode data transfer.

"1" (Permitted) : After the power is switched on, after a RESET condition occurs or when the first command is received following reception of a BUS DEVICE RESET message, if a SYNCHRONOUS DATA TRANSFER REQUEST (SDTR) message is not sent by the INIT, the IDD sends the SDTR message and attempts to establish synchronous mode data transfer.

"0"* (Prohibited): Even if it is necessary to establish synchronous mode data transfer, no SDTR message is sent from the IDD. However, if a SDTR message is sent from the INIT, the IDD responds normally.

* Set at shipping time

d) RSRTY (reselection retry)

This specifies the number of retries in the RESELECTION phase.

"1" *: Unlimited

"0": 10 times

* Set at shipping time

e) PHSCRC (Phase CRC)

This bit specifies where send or receive the CRC bytes in the DT Data IN/OUT transfer.

"1" * (Phase): After the all transfer is terminated or before the phase during data transfer changes other phase, the CRC bytes are sent or recieved.

"0" (Block): The CRC bytes are sent or recieved in each block boundary.

* Set at shipping time

The IDD ignores this specification and operates with the settings specified at shipping.

f) AGD (AIP generation disabled)

This specifies whether or not it is permitted to generate AIP (Asynchronous Information Protection).

"1" * (Prohibited): Prohibited generation

"0" (Permitted): Permitted generation

* Set at shipping time
The IDD ignores this specification and operates with the settings specified at shipping.

g) ACE (AIP checking enabled)

This specifies whether or not it is permitted to check AIP (Asynchronous Information Protection).

"1" (Permitted): Permitting check

"0"*(Prohibited): Prohibiting check

* Set at shipping time
The IDD ignores this specification and operates with the settings specified at shipping.

h) RTD (reselection timeout delay)

This specifies the reselection timeout delay time.

Bit 1	Bit 0	Reselection Time-out Delay
0	0	250 [ms]*
0	1	3 [ms]
1	0	Reserved
1	1	Reserved

* Set at shipping time

i) Spindle motor start delay time

This specifies the time after power on until the motor starts.

The IDD's motor starts after [(value specified in this parameter) x (IDD's SCSI ID x 0.1)] seconds from the power is switched on. If X '00' is specified in this parameter, the motor starts immediately after the power is switched on, no matter what SCSI ID is set in the IDD. Also, the IDD starts the motor immediately no matter what value is specified in this parameter.

This parameter is enabled only when set in the "Auto Motor Start Mode" with a setting terminal.

3.1.5 MODE SELECT (15)

Byte \ Bit	7	6	5	4	3	2	1	0
0	X'15'							
1	LUN			PF	0	0	0	SP
2	0	0	0	0	0	0	0	0
3	0	0	0	0	0	0	0	0
4	Parameter List Length							
5	0	0	0	0	0	0	0	Link

This command performs setting and changing of each type of parameter related to disk drive physical attributes, data format, timing of SCSI bus disconnect/reconnect processing and error recovery procedures, etc. The INIT can know the types of parameters, the current settings of each parameter and the types of parameters which can be changed, and the ranges for such changes, etc. by using the MODE SENSE or MODE SENSE EXTENDED command.

The data (MODE SELECT parameters) transferred from the INIT to the IDD by this command, are configured from a "Header," "Block Descriptor" and one or more "Page Descriptors" which describe each parameter, each of which will be explained later.

When the "PF (page format)" bit in CDB byte 1 is "1," it indicates that the MODE SELECT parameters transferred from the INIT by this command are in the "Page Descriptor" format. The IDD disregards the value specified in this bit and regards the MODE SELECT parameters transferred from the INIT as being in the "Page Descriptor" format and executes this command.

The "SP (save pages)" bit in CDB byte 1 specifies whether or not to save the MODE SELECT parameters specified in this command on the disk. It is possible for the IDD to save all the MODE SELECT parameters described in the "Page Descriptor" (except for those on page C), but this bit's specification is valid only for parameters other than "Format parameters (Page 3)" and "Drive parameters (Page 4: excluding byte 17)."

If "1" is specified in the "SP" bit, the parameters transferred from the INIT are saved to the disk when this command is executed, except for "Format parameters (page 3)" and "Drive parameters (Page 4: excluding byte 17)." When the "SP" bit is "0," these parameters are not saved to the disk. On the other hand, as for "Format parameters (Page 3)" and "Drive parameters (Page 4: excluding byte 17)," regardless of the specification of the "SP" bit when this command is executed, these parameters are always saved to the disk when the FORMAT UNIT command is executed.

The "Parameter length" field of the CDB specifies the total byte length of the MODE SELECT parameters transferred from the INIT by this command. If zero is specified in the "Parameter length" field, this command is terminated normally without data transfer being executed with the INIT. The MODE SELECT parameters have specifically defined formats and lengths, as explained by the descriptions of each page descriptor in this item, and the INIT must always specify (transfer) those formats and lengths.

If a "Header," "Block Descriptor" or any "Page Descriptor" cannot be transferred with all the defined length because the total defined length of the MODE SELECT parameters actually transferred from the INIT do not match the value specified in the "Parameter List Length" field, or if the total of the MODE SELECT parameter's defined length transferred from the INIT exceeds the value specified in the "Parameter list length" field, this command is terminated with a CHECK CONDITION status (ILLEGAL REQUEST [=5] / Invalid field in CDB [=24-00]) and all the MODE SELECT parameters transferred in the command are disabled.

Three types of values exist in the MODE SELECT parameters, "Current," "Save" and "Default" values. "Current" values are parameters which actually control the IDD's operation, and the parameters specified by this command are converted to "Current" values. "Save" values are parameter values specified by this command which are preserved on the disk. And "Default" values are values which the IDD uses as "Current" values during the time until reading of "Save" values is completed after the IDD's power is switched on, or when no "Save" values exist and no MODE SELECT command is being issued.

The IDD has a common set of "Current", "Save" and "Default" values of all the MODE SELECT parameters for all the INITs.

When the IDD's power is switched on, when a RESET condition occurs or when the IDD receives a BUS DEVICE RESET message, the "Current" MODE SELECT parameter values are changed to the "Save" parameter values, if they exist, and are changed to the "Default" parameter values if the "Save" values do not exist.

When any of the parameters related to the data format on the disk media (Block Descriptor, Format parameters: Page 3, and Drive parameters: Page 4), parameters related to the segment buffer (Caching parameters: Page 8, byte 13) and parameters related to command queuing (Control mode parameters: Page A, byte 3) is changed by this command, a UNIT ATTENTION condition (Mode parameters changed [=2A-01]) is generated for all the INITs other than the INIT that issued this command.

When the RESERVE command is issued which specifies the Third Party Reserve function, the "Current" values of MODE SELECT parameters of the INIT that issued the RESERVE command are copied to "Current" values for a third party device specified by the RESERVE command. Details of this function are described in Section 3.1.11, "RESERVE (16)."

Followings show the relation between the three types of parameters, "Current," "Save" and "Default".

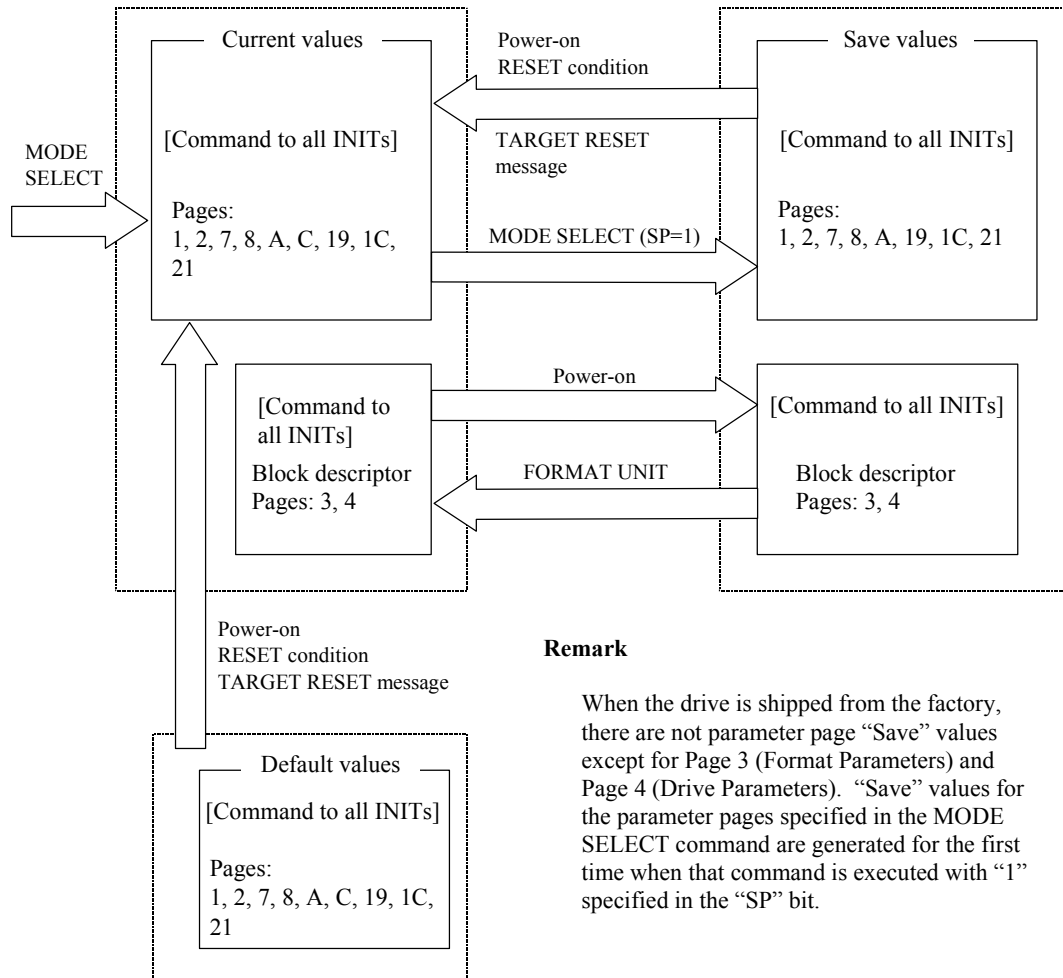
**Remark**

When the drive is shipped from the factory, there are not parameter page "Save" values except for Page 3 (Format Parameters) and Page 4 (Drive Parameters). "Save" values for the parameter pages specified in the MODE SELECT command are generated for the first time when that command is executed with "1" specified in the "SP" bit.

Figure 3.8 MODE SELECT parameter structure

The MODE SELECT parameters include parameters which can be changed by the INIT as desired, parameters which the INIT cannot change, which whose values are determined by the IDD unilaterally and parameters which can be changed by the INIT within certain appropriate limits. The IDD also contains parameter fields which are applicable for rounding processing ("rounding up" or "rounding down") of parameter values specified by the INIT to values which the IDD can use in actual operation.

When changing of parameters other than "variable parameters" is requested by the INIT in the MODE SELECT parameters which it transfers in this command, or when changes which are outside the permissible range are requested, even though they are "variable parameters," this command is terminated with a CHECK CONDITION status (ILLEGAL REQUEST [=5] / Invalid field in parameter list [=26-00]) and all the parameters specified by the INIT are disabled. Furthermore, parameter fields exist which ignore the values specified by the INIT, even if the parameters are "variable parameters." Details are explained in the description of each page descriptor in this item.

If the IDD performs rounding processing ("rounding up" or "rounding down") of parameter values specified by the INIT, in some cases a "CHECK CONDITION" status (RECOVERED ERROR [=1] / Rounded parameter [37-00]) is reported, and in some cases it is not reported. Whether or not a "CHECK CONDITION" status is reported is determined by the type of "rounding up" or "rounding down" and the conditions.

If the INIT would like to confirm that the IDD is implementing rounding processing, it issues a MODE SENSE or MODE SENSE EXTENDED command after issuing this command and reads the values for the "Current" parameters, then compares them with the parameter values sent in the MODE SELECT command.

Parameter fields which are the object of rounding processing are explained in the descriptions of each page descriptor in this item.

Figure 3.9 shows the data configuration of the parameter list transferred by the INIT in this command. The parameter list is configured from header 4 bytes in length followed by a block descriptor with a length of 8 bytes. This is followed by one or more page descriptors, or, when there is no block descriptor the 4-byte header is followed by one or more page descriptors. The INIT may transfer a header only, or the header and block descriptor only without the page descriptor added.

Header

Byte \ Bit	7	6	5	4	3	2	1	0
0	X'00'							
1	X'00' (Media Type)							
2	×	0	0	×	0	0	0	0
3	X'00' or X'08' (Product Descriptor Length)							

Block Descriptor

Byte \ Bit	7	6	5	4	3	2	1	0
0	Data Block Count (MSB)							
1	Data Block Count							
2	Data Block Count							
3	Data Block Count (LSB)							
4	X'00'							
5	Data Block Length (MSB)							
6	Data Block Length							
7	Data Block Length (LSB)							

Page Descriptor
[Page 0 Format (Short Page Format)]

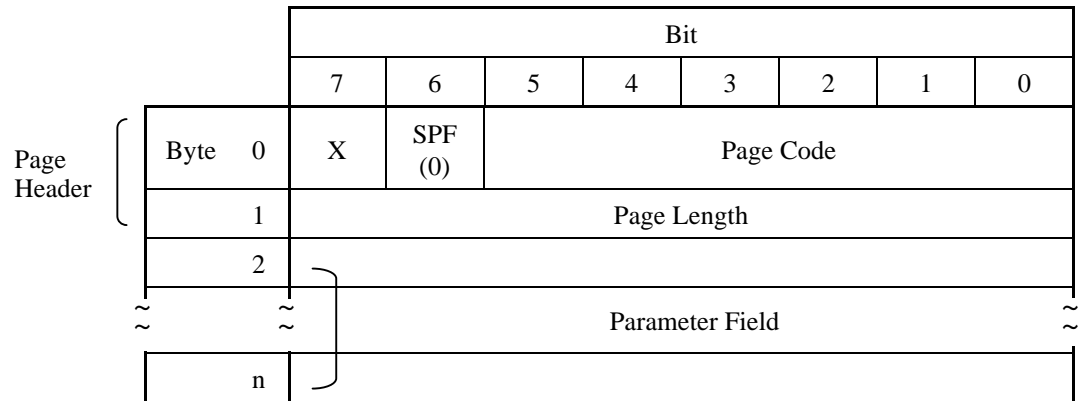

[Sub Page Format (Long Page Format)]

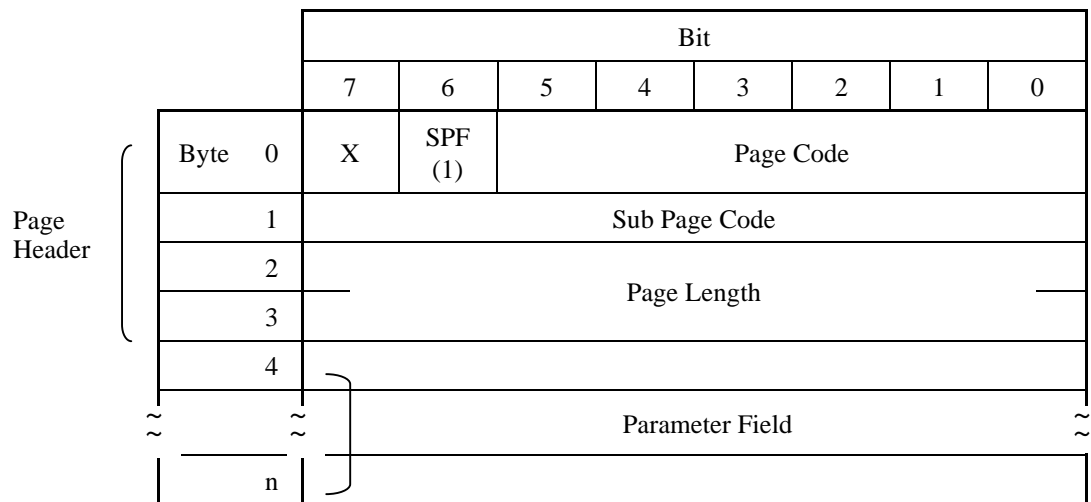

Figure 3.9 MODE SELECT command (Group 0) parameter configuration

- a. Header
 - Media type
X '00' (default type) must be specified in this field.
 - Byte 2
Bits 7 and 4 of this field have meaning only in the header transferred to the INIT by the MODE SENSE and MODE SENSE EXTENDED commands. The values specified in these bits are disregarded in the MODE SELECT and MODE SELECT EXTENDED commands. "0" must always be specified by the INIT in the other bit positions.

- Block descriptor length

This field indicates the length (block count) of the "Block descriptor" which follows the header (not including the length of the "Page descriptor"). It is possible to define only 1 "Block descriptor" to the IDD, and either X '00' or X '08' must be specified in this field. When X '00' is specified in this field, it indicates that the "Block descriptor" is not included in the parameter list transferred from the INIT and the "Page descriptor" follows immediately after the "Header."

- b. Block descriptor

The logical attributes of the data format on the disk media are described in the 8-byte long "Block descriptor."

- Data block count

This field specifies the total number of logical data blocks (the block length is specified in "Data block length") allocated in the user space on the disk media. The maximum logical block address is a value with 1 subtracted from the value in this field.

If only the "Block descriptor" in this command is changed accessible data block count can be limited without formatting if "Data block count" value is within a "Cylinder count" value of page 4.

If zero is specified for the "Data block count," or when the block descriptor is not specified, the IDD retains its current capacity, if the block size or alternate sector count has not changed. If the "Data block count" is set to zero and the Data block size or alternate sector count has changed, the IDD shall set to its maximum capacity when new block size or alternate sector count to be effect.

- Data block length

This field specifies the byte length of a logical data block on the disk media.

The logical data block length and physical data block length are the same in the IDD. The data block length can be specified at 512 to 528 bytes (4-byte boundary).

If less than 512 bytes is specified in this field, the IDD performs rounding processing (there is a rounding processing report), setting the data block length at 512 bytes. If more than 528 bytes is specified, rounding processing is performed (there is a rounding processing report), setting the data block length at 528 bytes. If the number except the multiple of 4 is specified within this range, the number is rounded up at the multiple of 4 that is closest to the specified number. (Rounding processing is reported.)

If zero is specified in this field, the value specified in bytes 12 and 13 (Data byte length/sector) of Page 3 (Format Parameter) is set. At that time, if Page 3 is not specified at the same time, the current value in Page 3 is used.

If the value set in this field differs from the value specified in bytes 12 and 13 (Data byte length/sector) of Page 3 (Format Parameter), the data block length in the block descriptor is set.

c. Page descriptor

The "Page descriptor" is configured from a 2-byte page header followed by a parameter field and each parameter function attribute is classified in a unit called a "Page." The individual "Page descriptors" in the MODE SELECT and MODE SELECT EXTENDED commands may be specified independently by the INIT and multiple "Page descriptors" may be specified continuously in the desired sequence.

• Page code

This field specifies a code (Page No.) that indicates the type of "Page descriptor."

• SPF (sub page format)

A setting of "0" in this bit indicates that Page_0 Format (Short Page Format) is used. A setting of "1" in this bit indicates that Sub_Page Format (Long Page Format) is used.

If "1" is specified for a page (excluding page 19) that does not support the Sub_Page Format, the MODE SELECT command terminates with the "CHECK CONDITION" status (ILLEGAL REQUEST [=5] / Invalid Field in Parameter List [=26/00]), and all parameters specified by this command are invalidated.

• Page length

This field indicates the length of the parameter field (number of bytes) after byte 2, excluding the page header, of the "Page descriptor" and is a fixed value for each page code. The INIT must specify the same value as the page length reported by the IDD in the MODE SENSE or MODE SENSE EXTENDED command, except in cases it is described in each of the page descriptor descriptions in this item.

d. MODE SELECT parameters of the IDD

The parameter list configuration and its length that can be transferred to the IDD by the INIT in the MODE SENSE or MODE SENSE EXTENDED command are as shown below. If a "Page descriptor" that is not supported by the IDD is specified, the command is terminated with a CHECK CONDITION status (ILLEGAL REQUEST [=5] / Invalid field in parameter list [=26-00]), and all the MODE SELECT parameters transferred in the command are disabled.

Parameter		Byte Length
Header		4
Block Descriptor		8 or 0
Page Descriptor	Page 1: Read/Write Error Recovery Parameter	8 or 12
	Page 2 Disconnect/Reconnect Parameter	12 or 16
	Page 3: Format Parameter	24
	Page 4: Drive Parameter	20 or 24
	Page 7: Verify Error Recovery Parameter	12
	Page 8: Caching Parameter	20
	Page A: Control Mode Parameter	12
	Page C Notch Parameter	24
	Page 19: Port Control Parameter (Sub Page 00)	8
	(Sub Page 01)	22
	Page 1C Information exceptions control parameter	12
Page 21: Additional Error Recovery Parameter	4	

Notes:

1. The MODE SELECT parameter is ordinarily different in its configuration depending on the input/output device and the type of controller. It is also possible that current definitions may be expanded in accordance with the expansion of the functions of the IDD in the future. In order to assure independence of software from the individual specifications of input/output devices, before the INIT issues this command, it should follow the procedure of using the MODE SENSE and MODE SENSE EXTENDED command to determine the types of parameters the TARG is actually equipped with and the attributes of those parameters, such as whether or not they can be changed.
2. After changing anything in the "Block descriptor" or "Format parameters (Page 3)" with the MODE SELECT or MODE SELECT EXTENDED command, it is impossible to execute a command to access the data on the disk media until execution of the FORMAT UNIT command is completed, and a CHECK CONDITION status (MEDIUM ERROR [=3] / Medium format corrupted [=31-00]) is reported for all such commands.

The configuration and functions of the "Page descriptors" supported by the IDD are described in Section 4.1.

Note:

In the diagram that shows the configuration of each individual "Page Descriptor," the default column shows that parameter's "default" value and the "variable" column shows whether or not it is possible to vary that parameter ("1" indicates that it can be varied). The INIT can know those values and attributes by using the MODE SENSE or MODE SENSE EXTENDED command.

3.1.6 MODE SELECT EXTENDED (55)

Byte \ Bit	7	6	5	4	3	2	1	0
0	X'55'							
1	LUN			PF	0	0	0	SP
2	0	0	0	0	0	0	0	0
3	0	0	0	0	0	0	0	0
4	0	0	0	0	0	0	0	0
5	0	0	0	0	0	0	0	0
6	0	0	0	0	0	0	0	0
7	Parameter List Length (MSB)							
8	Parameter List Length (LSB)							
9	0	0	0	0	0	0	0	Link

This command performs setting and changing of each type of parameter related to disk drive physical attributes, data format, timing of SCSI bus disconnect/reconnect processing and error recovery procedures, etc.

This command's function is the same as that of the Group 0 MODE SELECT command (Section 3.1.5), except that the format of its data transferred by the INIT differs partially from that of the (MODE SELECT) data format.

Figure 3.10 shows the configuration of the parameter list (MODE SELECT parameters) transferred by this command from the INIT. Compared to the 4-byte header in the Group 0 MODE SELECT command, it is necessary for an 8-byte header to be transferred in this command. The contents of each field in the header except that the byte positions differ, are the same as in the case of the Group 0 MODE SELECT command. The contents of the other parameters (Block descriptor, Page descriptor) are also the same as in the case of the Group 0 MODE SELECT command.

Header

Byte \ Bit	7	6	5	4	3	2	1	0
0	X'00'							
1	X'00'							
2	X'00' (Medium Type)							
3	×	0	0	×	0	0	0	0
4	X'00'							
5	X'00'							
6	X'00' (Block Descriptor Length: LSB)							
7	X'00' or X'08' (block descriptor length: MSB)							

Block Descriptor

Byte \ Bit	7	6	5	4	3	2	1	0
0	Data Block Count (MSB)							
1	Data Block Count							
2	Data Block Count							
3	Data Block Count (LSB)							
4	X'00'							
5	Data Block Length (MSB)							
6	Data Block Length							
7	Data Block Length (LSB)							

Page Descriptor
[Page 0 Format (Short Page Format)]

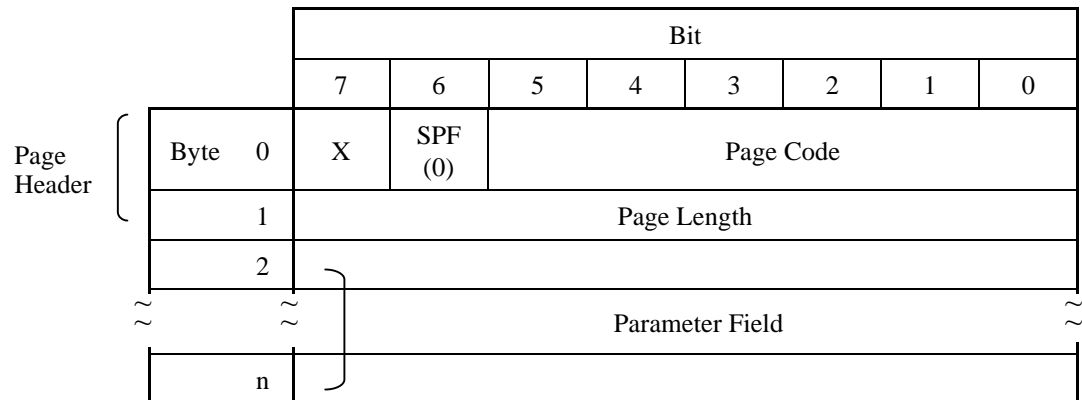

[Sub Page Format (Long Page Format)]

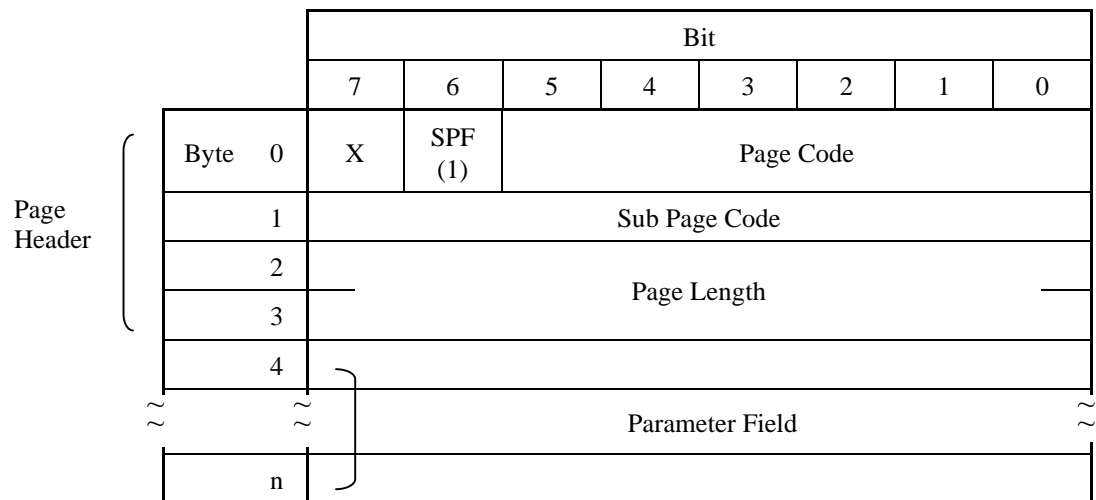

Figure 3.10 MODE SELECT EXTENDED command (Group 2) parameter configuration

3.1.7 MODE SENSE (1A)

		Bit							
		7	6	5	4	3	2	1	0
Byte	0	X '1A'							
	1	LUN			0	DBD	0	0	0
	2	PC		Page Code					
	3	Sub Page Code							
	4	Transfer Byte Length							
	5	0	0	0	0	0	0	0	Link

This command reports the values for each type of parameter related to the disk drive's physical attributes, data format, timing for SCSI bus disconnect and reconnect processing, error recovery procedures, etc., as well as the attributes of those parameters, to the INIT.

The data (MODE SENSE data) transferred to the INIT from the IDD by this command are configured from a "Header," "Block Descriptor" and one or more "Page descriptors" which describe each type of parameter, each of which will be described later in this item.

When "1" is specified in the "DBD (disable block descriptors)" bit of CDB byte 1, it indicates that a "Block descriptor" is not included in the MODE SENSE data transferred to the INIT by this command and the IDD transfers MODE SENSE data composed from the "Header" and the specified "Page descriptor" only to INIT. When "0" is specified in this bit, the IDD transfers MODE SENSE DATA composed of the "Header, " a single "Block descriptor" and the specified "Page descriptor" to the INIT.

The "Page code" field in CDB byte 2 specifies the page code of the "Page descriptor" transferred to the INIT by this command. The types of "Page descriptor" supported by the IDD and their page codes and lengths are as shown below.

Page Code: Page Descriptor Name		Page Byte Length		
		CCS	SCSI-2	SCSI-3
1:	Read/Write Error Recovery Parameter	8 bytes	12 bytes	12 bytes
2:	Disconnect/Reconnect Parameter	12 bytes	16 bytes	16 bytes
3:	Format Parameter	24 bytes	24 bytes	24 bytes
4:	Drive Parameter	20 bytes	24 bytes	24 bytes
7:	Verify Error Recovery Parameter	12 bytes	12 bytes	12 bytes
8:	Read Caching Parameter	20 bytes	20 bytes	20 bytes
A:	Control Mode Parameter	12 bytes	12 bytes	12 bytes
C:	Notch Parameter	24 bytes	24 bytes	24 bytes
19:	Port Control Parameter (Sub Page 00)	8 bytes	8 bytes	8 bytes
	(Sub Page 01)	22 bytes	22 bytes	22 bytes
	(Sub Page 02)	234 bytes	234 bytes	234 bytes
	(Sub Page 03)	14 bytes	14 bytes	14 bytes
	(Sub Page 04)	14 bytes	14 bytes	14 bytes
1C:	Information Exception Control Parameter	12 bytes	12 bytes	12 bytes
21:	Additional Error Recovery Parameter	4 bytes	4 bytes	4 bytes
3F:	All Page Descriptors Supported by the IDD			
	(Sub Page 00)	68 bytes	168 bytes	168 bytes
	(Sub Page FF)	68 bytes	452 bytes	452 bytes

When the value specified in the "Page code" field is other than X '3F', the specified "Page descriptor" only is transferred to the INIT, and when X '3F' is specified, all the "Page descriptors" supported by the IDD are transferred to the INIT in the ascending order of the page code, but if SCSI-1/CCS is specified by the CHANGE DEFINITION command (SCSI level), Page code 7, Page code 8, Page code A, Page code C and Page code 1C are not transferred. Also, when X '00' is specified in the "Page code field," the "Page descriptor" is not transferred. If page codes other than the abovementioned ones ("Page descriptors" which are not supported by the IDD) are specified, the command is terminated with a CHECK CONDITION status (ILLEGAL REQUEST [=5] / Invalid field in CDB [=24-00]).

(Operations depending on page code and subpage code)

Page code	Subpage code	Operation
00h	00h	Vender Specific (No page format is required.) - Reports the contents of the header (if required) and block descriptor.
	01h – FFh	Vender Specific (No page format is required.) - Terminates with an error (5/24/00).
01 – 1Fh	00h	Page_0 Format - Reports the contents of the specified pages (excluding page 19). - For page 19, reports the contents of subpage X'00' (Short Page).
	01h – DFh	Sub_Page Format - For pages excluding page 19, terminates with an error (5/24/00). - For page 19, reports the contents of subpages X'01', X'03', and X'04' (Long Page). For other pages, terminates with an error (5/24/00).
	E0h – DFh	Vender Specific (Sub_Page Format) - Terminates with an error (5/24/00).
	FFh	Reports the contents of subpage X'00' (Page_0 Format) of the specified page and all subpages X'01' to X'FE' (Sub_Page Format). - For pages excluding page 19, terminates with an error (5/24/00). - For page 19, reports the contents of all subpages X'00', X'01', X'03', and X'04' (Short, Long Page).
20h – 3Eh	00h	Vender Specific (Page_0 Format) - Same as "page code X'01' - X'1F' "
	01 - FEh	Vender Specific (Sub_Page Format) - Same as "page code X'01' - X'1F' "
	FFh	Reports the contents of subpage X'00' (Page_0 Format) of the specified page and all subpages X'01' - X'FE' (Sub_Page Format). - Same as "page code X'01' - X'1F' "
3Fh	00h	Reports the contents of all pages or subpage X'00' (Page_0 Format). - Reports the contents of all supported pages. For page 19, the contents of subpage X'00' (Short Page) are reported.
	01h – FEh	Reserved - Terminates with an error (5/24/00).
	FFh	Reports all pages or subpage X'00' (Page_0 Format) and all subpages X'01' -X'FE' (Sub_Page Format). - Reports the contents of all supported pages. For page 19, all subpages X'00', X'01', X'03', and X'04' (Short, Long Page) are reported.

Remark:

For Page_0 Format and Sub_Page Format, see the description below.

The "PC (page control)" field of CDB byte 2 specifies the type of parameter value in the "page descriptor" transferred by this command to an INIT

Note:

Even in cases where the value specified in the MODE SELECT or MODE SELECT EXTENDED command is described in Table 3.1 as the value reported to the INIT by this command, if parameter rounding processing is applied by the IDD, or in cases of a parameter or bit with a specified value that is disregarded, different values than those specified by the INIT will be reported. For details, see the descriptions of each page descriptor (in Section 3.1.5). Also, "0" is reported in byte positions and bit positions which are reserved in each page descriptor.

Table 3.1 MODE SENSE Data Type Specifications

PC	Type of Parameter Transferred to the INIT
00	<p>Current Values:</p> <p>Reports each "Current" parameter value. The "Current" values are either of the following values.</p> <ul style="list-style-type: none"> • Values specified by a MODE SELECT or MODE SELECT EXTENDED command which is finally normally terminated. • When a MODE SELECT or MODE SELECT EXTENDED command is not executed after the power is switched on, after a RESET condition or after a BUS DEVICE RESET message issued by any INIT is received, the same values as "Save" values. However, if "Save" values do not exist for parameters other than those on Page 3 and Page 4 (excluding byte 17), the same values as "Default" values.
01	<p>Variable Values:</p> <p>The INIT reports variable parameter fields and parameter bits through the MODE SELECT or MODE SELECT EXTENDED command. A "1" is reported in the variable fields and bit positions in each page descriptor and "0" is reported in the fields and bit positions which cannot be changed. See the description of each page descriptor for the MODE SELECT command (Section 3.1.5) concerning the variability of each parameter.</p>
10	<p>Default Values:</p> <p>Reports the "Default" value of each parameter. See the description of each page descriptor for the MODE SELECT command (Section 3.1.5) concerning the actual default value of each parameter.</p>
11	<p>Save Values:</p> <p>Reports the "Save" value of each parameter. The "Save" values are either of the following values.</p> <ul style="list-style-type: none"> • For parameters other than those on Page 3 and Page 4 (excluding byte 17), these are the values specified in a MODE SELECT or MODE SELECT EXTENDED command in which the "SP" bit after the final execution is completed is "1." When a MODE SELECT or MODE SELECT EXTENDED command in which the "SP" bit is "1" is not executed (when "Save" values do not exist), these are the same values as the "Default" values. • The values in the parameters in Page 3 and Page 4 (excluding byte 17) are the values save to the disk media during execution of the FORMAT UNIT command.

The "Transfer Byte Length" field in the CDB specifies the total number of bytes of MODE SENSE data which can be transferred to the INIT by this command. The IDD transfers the number of bytes of all the MODE SENSE data specified in the "Page code" field or the portion of MODE SENSE data with the length specified in the "Transfer Byte Length" field, whichever is smaller. When zero is specified in the "Transfer Byte Length" field, this command is terminated without anything being transferred.

Figure 3.11 shows the data configuration in the parameter list (MODE SENSE data) transferred to the INIT by this command. The parameter list consists of a 4-byte header, an 8-byte block descriptor and one or more page descriptors, specified in the CDB, which are transferred in order. However, when "1" is specified in the DBD bit of the CDB, the block descriptor is not transferred. Also, when X '00' is specified in the "Page code" field of the CDB, the page descriptor is not transferred.

Header

		Bit							
		7	6	5	4	3	2	1	0
Byte	0	Sense Data Length							
	1	X '00' (Media Type)							
	2	WP	0	0	DPOFUA	0	0	0	0
	3	X '00' or X '08' (Block Descriptor Length)							

Block Descriptor

		Bit							
		7	6	5	4	3	2	1	0
Byte	0	Data Block Count (MSB)							
	1	Data Block Count							
	2	Data Block Count							
	3	Data Block Count (LSB)							
	4	X '00'							
	5	Data Block Length (MSB)							
	6	Data Block Length							
	7	Data Block Length (LSB)							

Figure 3.11 MODE SENSE command (Group 0) parameter configuration (1 of 2)

Page Descriptor
[Page 0 Format (Short Page Format)]

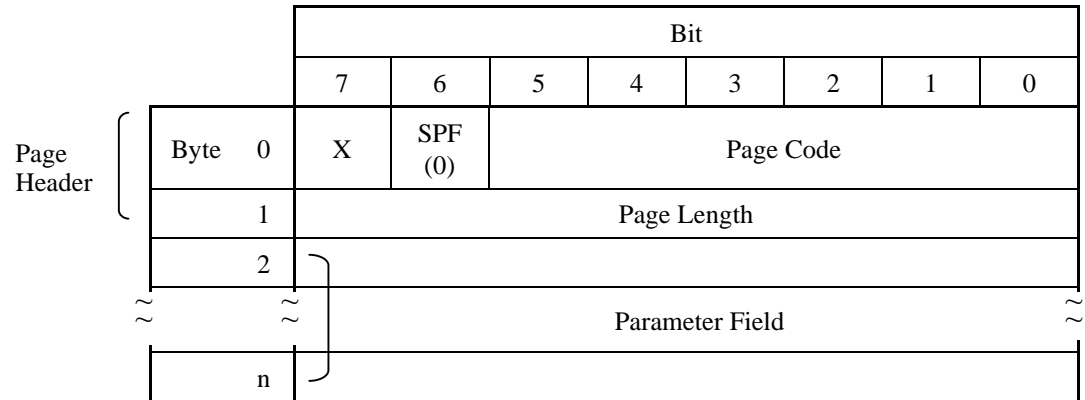

[Sub Page Format (Long Page Format)]

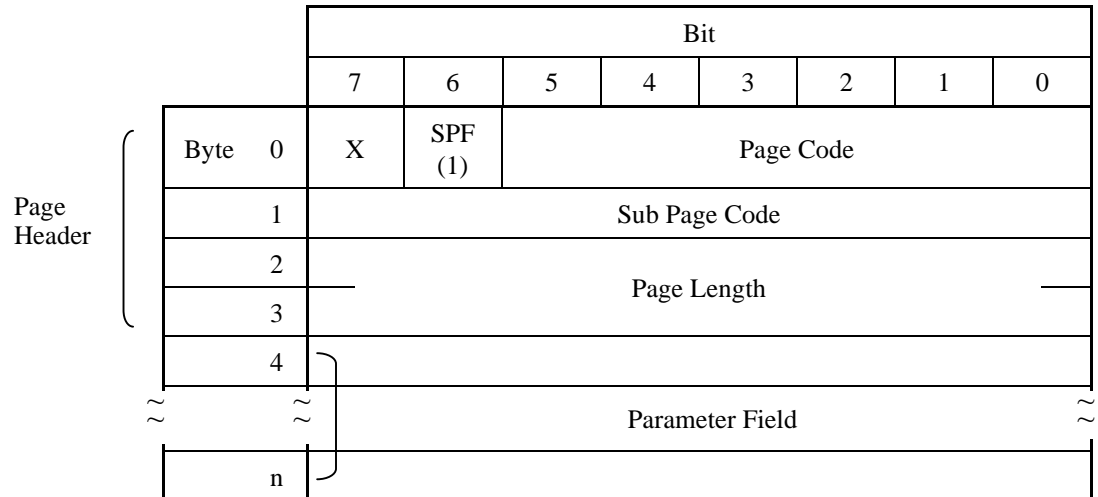

Figure 3.11 MODE SENSE command (Group 0) parameter configuration (2 of 2)

(1) Header

a. Sense data length

This field indicates the length (number of bytes) of the parameter list (MODE SENSE data) which it is possible to transfer to the INIT by this command. The length of the "Sense data length" field itself is not included in this value. Also, a value for a portion of data with a length that is supported by the IDD is reported in this field for a parameter list of the type specified in the CDB regardless of the specification of the "Transfer byte length" field in the CDB. In order for the INIT to confirm that all the parameter list requested in the command has been transferred, it should check whether the value which has the length of the "Sense data length" field itself added to the value indicated in this field is less than the value specified in the "Transfer byte length" field.

b. Media type

X '00' (default type) is always reported in this field.

c. WP bit

When this bit is "1," it indicates that a write operation to the disk media is prohibited and when "0" is specified, it indicates that a write operation is permitted. Prohibition or permission of a write operation can be specified through the setting terminal (write protect) on the IDD. See "Product Specifications/Installation Procedures" in the Product Manual concerning the setting terminal.

d. DPOFUA bit

When this bit is "0", it indicates that the IDD does not support the DPO and FUA bits. When this bit is "1", it indicates that the IDD supports the DPO and FUA bits.

e. Block descriptor length

This field indicates the "Block descriptor" length (byte length) which follows after the header. The "Page descriptor" length is not included in this value. The IDD always reports X '08' in this field if "0" is specified in the DBD bit of this command's CDB, and thus indicates that one "Block descriptor" set follows after the header. When "1" is specified in the DBD bit of the CDB, the value of this field is X '00'.

(2) Block descriptor

The 8-byte "Block descriptor" indicates the logical attributes of the data format on the disk media.

a. Data block count

This field indicates the total number of logical data blocks (the block length is shown in the "Data block length" field) existing in the "User Space" on the disk media. This value does not include the number of spare sectors reserved for alternate block processing.

Furthermore, when this command specifies to transfer the "Default" value and "Variable" value, the value shown in this field is X '00000000' (which means the maximum number of logical data blocks that it is possible to rank in the "User Space").

b. Data block length

This field indicates the length (byte length) of 1 logical data block on the disk media.

(3) Page descriptor

The "Page descriptor" is configured from a parameter field which follows a 2-byte (4-byte for the sub page format) page header, and is divided into units called "Page" for each parameter's functional attributes. See the description of the MODE SELECT command (Section 3.1.5) concerning the configuration of each page descriptor and their contents.

a. PS bit

When this bit is "1," the parameter value defined in that "Page descriptor" can be saved on the disk media, and when it is "0", it indicates that this is a parameter which cannot be saved to the disk. It is possible to save all the "Page descriptors" supported by the IDD. However, "1" is always indicated in this bit for all "Page descriptors" transferred by this command.

b. SPF (sub page format)

A setting of "0" in this bit indicates that Page_0 Format (Short Page Format) is used. A setting of "1" in this bit indicates that Sub_Page Format (Long Page Format) is used.

c. Page length

This field indicates the length of the parameter field (number of bytes) from byte 2 (4 for the sub page format), excluding the page header of that "Page descriptor." The IDD always shows a value in this field which is the same as the length defined in that "Page descriptor" regardless of the type of parameter requested in the "PC (page control)" field of the CDB, and reports all the parameter fields that "Page descriptor" in byte 2 and subsequent bytes.

d. Parameter field

The parameter field in byte 2 (4 for the sub page format) and subsequent bytes, indicates parameter values of the type (current values, variable values, default values or save values) requested in the "PC (page control)" field of the CDB. See the description of the MODE SELECT command (Section 3.1.5) concerning the definition of each parameter, "Default" values and "Variable" values.

3.1.8 MODE SENSE EXTENDED (5A)

		Bit							
		7	6	5	4	3	2	1	0
Byte	0	X '5A'							
	1	LUN			0	DBD	0	0	0
	2	PC		Page Code					
	3	0	0	0	0	0	0	0	0
	4	0	0	0	0	0	0	0	0
	5	0	0	0	0	0	0	0	0
	6	0	0	0	0	0	0	0	0
	7	Transfer Byte Length (MSB)							
	8	Transfer Byte Length (LSB)							
	9	0	0	0	0	0	0	0	Link

This command reports the values for each type of parameter related to the disk drive's physical attributes, data format, timing for SCSI bus disconnect and reconnect processing, error recovery procedures, etc., as well as the attributes of those parameters, to the INIT.

The functions of this command are the same as those of the Group 0 MODE SENSE command (Section 3.1.7) except that the format of data (MODE SENSE data) transferred to the INIT differs somewhat.

Figure 3.12 shows the data configuration of the parameter list (MODE SENSE data) transferred to the INIT by this command. Compared to the 4-byte header in the case of a Group 0 MODE SENSE command, an 8-byte header is transferred in this command. The meanings of each field and bit in the header are the same as in the case of the Group 0 MODE SENSE command, except that the byte positions differ. Also, the contents of the other parameters (block descriptor and page descriptors) are the same as in the case of the Group 0 MODE SENSE command.

Header

		Bit							
		7	6	5	4	3	2	1	0
Byte	0	Sense Data Length (MSB)							
	1	Sense Data Length (LSB)							
	2	X '00' (Media Type)							
	3	WP	0	0	DPOFUA	0	0	0	0
	4	X '00'							
	5	X '00'							
	6	X '00' (Block Descriptor Length: MSB)							
	7	X '00' or X '08' (Block Descriptor Length: LSB)							

Block Descriptor

		Bit							
		7	6	5	4	3	2	1	0
Byte	0	Data Block Count							
	1	Data Block Count (MSB)							
	2	Data Block Count							
	3	Data Block Count (LSB)							
	4	X '00'							
	5	Data Block Length (MSB)							
	6	Data Block Length							
	7	Data Block Length (LSB)							

Figure 3.12 MODE SENSE EXTENDED command (Group 2) parameter configuration (1 to 2)

Page Descriptor
[Page 0 Format (Short Page Format)]

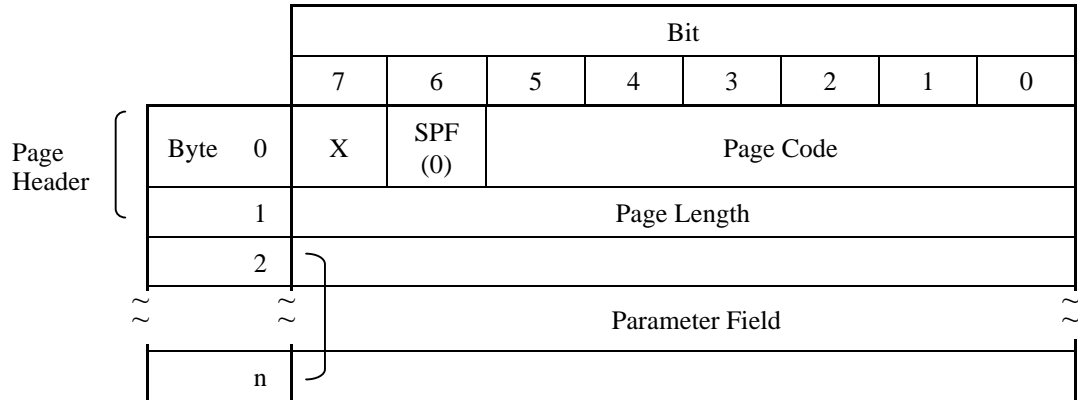

[Sub Page Format (Long Page Format)]

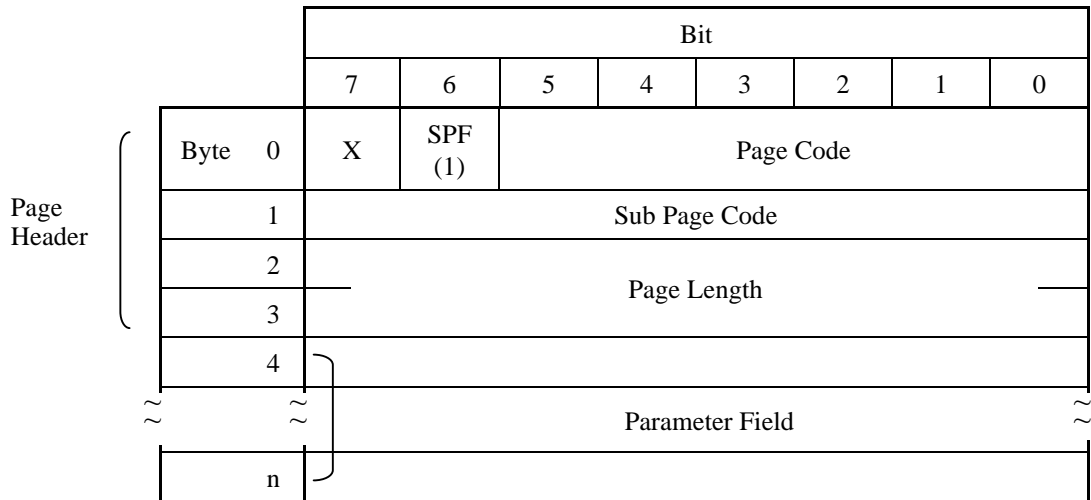

Figure 3.12 MODE SENSE EXTENDED command (Group 2) parameter configuration (2 of 2)

3.1.9 REZERO UNIT (01)

Byte \ Bit	7	6	5	4	3	2	1	0
0	X'01'							
1	LUN			0	0	0	0	0
2	0	0	0	0	0	0	0	0
3	0	0	0	0	0	0	0	0
4	0	0	0	0	0	0	0	0
5	0	0	0	0	0	0	0	Link

This command moves the read/write heads of the disk drive to the initial position. A data block with the logical block address of zero exists at the initial position (cylinder 0 / track 0). Initialization of the disk drive's positioning control system and automatic adjustment are also performed by this command.

3.1.10 START/STOP UNIT (1B)

Byte \ Bit	7	6	5	4	3	2	1	0
0	X'1B'							
1	LUN			0	0	0	0	Immed
2	0	0	0	0	0	0	0	0
3	0	0	0	0	0	0	0	0
4	0	0	0	0	0	0	LoEj	Start
5	0	0	0	0	0	0	0	Link

This command controls starting and stopping of the disk drive's spindle motor. Control of the spindle motor is performed through the "Start" bit in bit 0 of the CDB byte 4.

The spindle motor can be stopped if this command is issued with the "Start" bit as "0." On the other hand, the spindle motor can be started by specifying "1" in the "Start" bit.

Bit 1 (LoEj (Load/Eject) of byte 4 of the CDB is the exclusive bit which controls devices with replaceable recording media, and it has no meaning for the IDD. The IDD disregards the value specified in this bit and controls starting and stopping of the spindle motor in accordance with the "Start" bit only.

It is possible to select the disk drive's spindle motor starting mode through the setting terminal on the IDD. If prohibition of motor starting control is set by this command at the setting terminal, the spindle motor starts automatically when the IDD's power is switched on. It is also possible to delay the starting time through the specifications in the CHANGE DEFINITION command. When the setting terminal is being set to perform motor starting control by command, the IDD's spindle motor will not start even when the power is switched on. In this case, it is necessary for the INIT to issue a command to start the spindle motor. See the description of the motor starting mode in Section 5.3.2 of the Product Manual concerning the setting terminal.

Note:

The setting terminal specifies only the spindle motor starting method at power on time, and whichever mode is set, this command is valid.

The INIT can issue this command whenever it is desired and stop or start the spindle motor regardless of the state of the setting terminal.

Depending on the value specified in the "Immed (immediate)" bit, bit 0 of CDB byte 1, the timing of completion (status report) of this command differs as shown below.

- a. In the case of the start specification ("Start" bit = "1")
 - When the "Immed" bit is "1," simply by instructing starting of the spindle motor, a GOOD status is reported without waiting until the disk drive is in the Ready state, and command execution is completed.
 - When the "Immed" bit is "0," the status is reported, and command execution is completed, at the point when the disk drive has entered the Ready state after the spindle motor has started.
- b. In the case of the stop specification ("Start" bit = "0")
 - When the "Immed" bit is "1," simply by instructing stopping of the spindle motor, the GOOD status is reported and command execution is completed.
 - When the "Immed" bit is "0," the status is reported, and command execution is completed, after the spindle motor is in the stopped state.

Notes:

1. When this command with the Start instruction is issued with a link to another command, the specification in the "Immed" bit should be "0." If "1" is specified for the "Immed" bit, ordinarily, the disk drive is still not in the Ready state at the point when this command is completed, so a linked command cannot be executed normally
2. Even if "1" is specified in the "Immed" bit of this command, if other commands are already queued and another command exists which is already being executed, this command is placed on the queue and disconnect processing is performed. Therefore, even if "1" is specified in the "Immed" bit, the status will not necessarily be reported immediately after the COMMAND phase.

3.1.11 RESERVE (16)

Byte \ Bit	7	6	5	4	3	2	1	0
0	X'16'							
1	LUN			3rd Pty	3rd Pty Dev ID			0
2	×	×	×	×	×	×	×	×
3	×	×	×	×	×	×	×	×
4	×	×	×	×	×	×	×	×
5	0	0	0	0	0	0	0	Link

Together with the RELEASE command, this command controls exclusive access to the logical unit (IDD) under a multi-initiator environment.

The IDD is reserved by this command for the INIT which issued this command or for some other SCSI device specified in the CDB.

The INIT which issues this command must notify the IDD of its own SCSI ID when the SELECTION phase is executed.. When the INIT's ID cannot be specified, this command is terminated with a CHECK CONDITION status (ILLEGAL REQUEST [=5] / Initiator's SCSI ID not identified [=90-00]) without being executed. Also, the values specified in bytes 2 to 4 of the CDB have no meaning and are disregarded, but it is preferable that the INIT specify X '00' in these bytes.

(1) Logical unit reserve function

This command reserves the entire IDD (logical unit) for use as a special SCSI device. The reserve state established by this command is maintained until any one of the following conditions occurs.

- 1) The reserve condition is changed by the INIT that issued this command (Superseding Reserve).
- 2) Reserve is released by a RELEASE command from the INIT that issued this command.
- 3) A TARGET RESET message from any INIT.
- 4) A RESET condition.
- 5) Switching the IDD's power off and on.

When an IDD is reserved for any SCSI device, if this command is issued by an INIT that doesn't have the "Reserve Right" for that IDD, this command is terminated with a RESERVATION CONFLICT status. See item (3) concerning the "Reserve Right."

After the Reserved status is established, a command issued by an INIT other than the SCSI device that reserved the IDD is rejected, except an INQUIRY, REPORT LUNS, REQUEST SENSE or RELEASE command, and a RESERVATION CONFLICT status is reported to the INIT that issued that command. The INQUIRY REPORT LUNS, and REQUEST SENSE commands are executed normally even when the IDD is reserved for use by another SCSI device. Also, a RELEASE command is terminated with a GOOD status, but the release operation specified in a RELEASE command issued to the IDD by a SCSI device which does not have the Reserve Right is disregarded.

(2) Reserve right and third party reserve function

If the "3rd Pty" bit in byte 1 of the CDB is "0," the IDD is reserved by the INIT which issued this command and that INIT has the Reserve right for the IDD.

If the "3rd Pty" bit is "1," the third party reserve function is specified. An INIT which specifies the third party reserve function and issues this command can reserve the IDD for use by another SCSI device. In this case, this command reserves the IDD for the SCSI device (called the third party device) with the SCSI ID specified in the "3rd Pty Dev ID" field in byte 1 of the CDB. Even if the IDD is reserved for another SCSI device using the third party reserve function the reserve right for that ID resides with the INIT that issued this command. Therefore, in order to release that reserve state, it is necessary for the INIT that issued this command to issue a RELEASE command (shown in Section 3.1.13) with the third party release function specified. Also, the conditions for maintaining the reserve state established by the third party reserve function are the same as in the case where the third party reserve function is not used. (See item (1).)

Please note that since only 3 bits are defined for the "3rd Pty Dev ID" field, this command is valid for the third party reserve function with respect to only SCSI devices with SCSI ID 7 to 0.

(3) Changing the reserve conditions (Superseding Reserve)

The INIT which has the reserve right for an IDD (the INIT which has issued this command in the past and has established the IDD reserve state) can change the IDD's reserve conditions by issuing a another RESERVE command (Superseding Reserve).

When a superseding reserve is executed, the IDD releases the reserve state it was in up to that point and establishes a new reserve state in accordance with the specifications in this newly issued command.

By using this function, the INIT can, for example, change the SCSI device (SCSI ID) for which the logical unit is reserved while continuing the reserve state of the logical unit with which the reserve state was established using the previous third party reserve function.

- **Reserve right and the third party reserve function**

Remark

In order to clarify the jurisdiction related to reserve and release, the term "Reserve Right" is used in this manual.

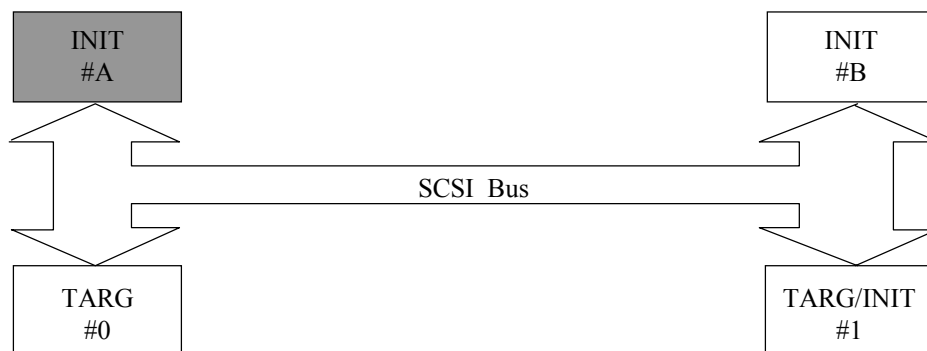

1. If INIT #A issues a RESERVE command which does not specify the third party reserve function to TARG #0, TARG #0 enters the reserved state from INIT #A and INIT #A has the reserve right with respect to TARG #0. In this case,
 - INIT #A has an exclusive monopoly over TARG #0.
 - Any commands issued to TARG #0 by any other SCSI device (INIT #B, TARG/INIT #1) are rejected with a RESERVATION CONFLICT status, with the exception of an INQUIRY, REPORT LUNS, REQUEST SENSE or RELEASE command. The RELEASE command is terminated normally, but TARG #0's reserve state is not influenced by it.
2. If INIT #A issues a RESERVE command which specifies the third party reserve function ("3rd Pty Dev ID" = TARG/INIT#1), TARG #0 becomes reserved from TARG/INIT #1, but INIT #A has the reserve right. In this case,
 - TARG/INIT #1 has an exclusive monopoly of TARG #0. However, if TARG/INIT#1 issues a RESERVE command, that command is rejected with a RESERVATION CONFLICT status. Also, a RELEASE command is terminated normally, but it has no influence on the TARG #0 reserve right.
 - INIT #A can issue INQUIRY, REQUEST SENSE, RELEASE and RESERVE commands to TARG #0, but other commands are rejected with a RESERVATION CONFLICT status. A RELEASE or RELEASE EXTENDED command issued by INIT #A releases TARG #0's reserved state. Also, a RESERVE or RESERVE EXTENDED command changes the reserve state of TARG #0.
 - Commands issued by INIT #B to TARG #0 are rejected with a RESERVATION CONFLICT status, except the INQUIRY, REPORT LUNS, REQUEST SENSE and RELEASE commands. A RELEASE command is terminated normally, but it has no influence on the TARG #0 reserve right.
3. An example of the third party reserve function is applicable when using the COPY command. For example, TARG/INIT #1 supports the COPY command, uses the COPY command and in the case that a data transfer between TARG #0 and TARG/INIT#1 is executed, if the third party reserve in 2) is executed before INIT #A issues a COPY command to TARG/INIT #1, access to TARG #0 by INIT #B during execution of the COPY command can be prohibited.

3.1.12 RESERVE EXTENDED (56)

Byte \ Bit	7	6	5	4	3	2	1	0
0	X'56'							
1	LUN			3rd Pty	0	0	0	0
2	×	×	×	×	×	×	×	×
3	Third Party Device ID							
4	0	0	0	0	0	0	0	0
5	0	0	0	0	0	0	0	0
6	0	0	0	0	0	0	0	0
7	×	×	×	×	×	×	×	×
8	×	×	×	×	×	×	×	×
9	0	0	0	0	0	0	0	Link

This command controls exclusive access to a logical unit (IDD) under a multi-initiator environment together with the RELEASE and RELEASE EXTENDED commands.

The IDD is reserved by the INIT that issued this command or for another SCSI device specified in the CDB.

The functions of this command are the same as for the Group 0 RESERVE command (Section 3.1.11), except that it is possible to specify the third party reserve function to SCSI devices with SCSI IDs 15 to 8.

3.1.13 RELEASE (17)

Byte \ Bit	7	6	5	4	3	2	1	0
0	X'17'							
1	LUN			3rd Pty	3rd Pty Dev ID			0
2	×	×	×	×	×	×	×	×
3	0	0	0	0	0	0	0	0
4	0	0	0	0	0	0	0	0
5	0	0	0	0	0	0	0	Link

This command releases the reserve state of an IDD in relation to the INIT that issued this command.

When a reserve state in relation to the INIT that issues this command, or an IDD in the type of reserve state which is the release object specified in the CDB of this command does not exist, or even when the IDD is reserved by another SCSI device, this command is terminated normally with a GOOD status, but it is no influence on the IDD's reserve state.

The INIT that issues this command must notify its own SCSI ID when the SELECTION phase is executed. When the INIT's ID cannot be specified, this command is terminated with a CHECK CONDITION status (ILLEGAL REQUEST [=5] / Initiator's SCSI ID not identified [=90-00]) without this command being executed. Also, the value specified in CDB byte 2 has no meaning and is disregarded, but it is desirable for X'00' to be specified by the INIT in this byte.

(1) Release function

This command releases a reserve state if a reserve state exists, and if the INIT which issued this command has a reserve right for the entire IDD (logical unit). See Reserve Right and Third Party Reserve Function in RESERVE command (Section 3.1.11) concerning the definition of "Reserve Right."

(2) Release object and third party release function

When the "3rd Pty" bit in CDB byte 1 is "0," this command cancels a reserve state if it exists in the IDD that has been reserved by a RESERVE command without the INIT that issued this command specifying the third party reserve function.

When the "3rd Pty" bit is "1," the third party release function is specified and this command can release a reserve state established in the past by the third party reserve function. When the third party release function is specified, this command releases the reserve state only when the INIT that issued this command is the same as the INIT that used the RESERVE command in the past to specify the third party reserve function which caused the IDD to be reserved for the SCSI device (third party device) specified in the "3rd Pty Dev ID" field in CDB byte 1 of this command.

Since only 3 bits are defined in the "3rd Pty Dev ID" in this command, the third party release function is valid only for SCSI devices with SCSI IDs 7 to 0.

3.1.14 RELEASE EXTENDED (57)

Byte \ Bit	7	6	5	4	3	2	1	0
0	X'57'							
1	LUN			3rd Pty	0	0	0	0
2	×	×	×	×	×	×	×	×
3	Third Party Devices ID							
4	0	0	0	0	0	0	0	0
5	0	0	0	0	0	0	0	0
6	0	0	0	0	0	0	0	0
7	×	×	×	×	×	×	×	×
8	×	×	×	×	×	×	×	×
9	0	0	0	0	0	0	0	Link

This command releases the reserve state of an IDD in relation to the INIT which issued this command.

This command function is the same as that of the Group 0 RELEASE command (Section 3.1.13), except that it is also possible to specify the third party release function for SCSI devices with SCSI IDs 15 to 8.

3.1.15 REQUEST SENSE (03)

Byte \ Bit	7	6	5	4	3	2	1	0
0	X'03'							
1	LUN			0	0	0	0	0
2	0	0	0	0	0	0	0	0
3	0	0	0	0	0	0	0	0
4	Transfer Byte Length							
5	0	0	0	0	0	0	0	Link

This command transfers sense data to the INIT. This command is executed immediately without queuing in a system which issues only commands with no tags or links.

The length of the sense data in the IDD is 48 bytes. The "Transfer byte length" field in the CDB indicates the number of bytes of sense data which can be received by the INIT. The IDD transfers sense data to the INIT by either of the following two methods, depending on the specification in the CHANGE DEFINITION command (SCSI level). Furthermore, see Section 3.1.4 (SCSI Level) concerning the CHANGE DEFINITION command.

- If the SCSI-3/SCSI-2 mode is specified in the CHANGE DEFINITION command, the IDD transfers the number of bytes of sense data specified in the "Transfer byte length" field or the number of bytes in the sense data held by the IDD (48 bytes), whichever is smaller, to the INIT. When zero is specified in the "Transfer byte length" field, this command is terminated with nothing transferred, but in this cases also, the sense data held by the IDD are cleared.
- If SCSI-1/CCS Mode is specified in the CHANGE DEFINITION command, when zero is specified in the "Transfer byte length" field, the IDD transfers to the INIT only 4 bytes of sense data, from the top. When a value other than zero is specified in the "Transfer byte length" field, the IDD transfers to the INIT the number of bytes of sense data specified in the "Transfer byte length" field or the length of sense data held by the IDD (48 bytes), whichever is smaller.

As described in Section 1.6 "Sense Data Hold State," if the IDD terminates a command which it is currently executing abnormally, it generates sense data for the INIT that issued that command and maintains those sense data in the hold state.

Sense data are held in a valid state until they are read by a REQUEST SENSE command from the INIT for which they are held. However, sense data which are being held are cleared by an ABORT TASK SET message from the INIT for which they are held, a TARGET RESET message or CLEAR TASK SET message from any INIT, or a RESET condition.

If a command is terminated with a CHECK CONDITION status, when the SCSI bus enters the BUS FREE phase unintentionally during execution of a command, or when the INIT detects that there is no reconnection request from the IDD, the INIT should issue this command and fetch the sense data.

Note:

See Section 1.6, "Sense Data Hold State" concerning details of the sense data hold state and see Section 5.1, "Sense Data" concerning the format of sense data transferred by this command from the IDD to the INIT, and its contents.

If this command is issued while the IDD is holding the UNIT ATTENTION condition, if the IDD is not in the sense data hold state at that point, sense data indicating the UNIT ATTENTION condition are sent to the INIT by this command and the UNIT ATTENTION condition is cleared. For details, see Section 1.5, "UNIT ATTENTION Condition."

If this command is issued when valid sense data are not being held, the IDD sends the sense key "NO SENSE[=0]" with sense data showing the message "No additional sense information [=00-00]" to the INIT.

This command is terminated abnormally with a CHECK CONDITION status reported only when the conditions shown below are detected. In this case, new sense data are generated and the sense data which had been held up to that point are lost.

- An error in a specification other than the LUN field of the CDB
- Sense data cannot be sent due to a hardware error in the IDD
- An unrecoverable error is detected on the SCSI bus.

- A state appropriate to an overlapping command exception condition (see Section 1.7.1).

In cases other than the above, the sense data currently being held, or, when there are no sense data being held, the sense data which indicate the state if an error occurred during execution of this command, are sent to the INIT and it is terminated with a GOOD status. However, if an error which has been recovered from by retry processing is detected during execution of this command, and if the mode which reports "RECOVERED ERROR" is specified, this command is terminated with a CHECK CONDITION status after sense data are sent to the INIT and sense data (RECOVERED ERROR [=1]) which indicate the contents of that error are newly generated.

3.1.16 LOG SELECT (4C)

Byte \ Bit	7	6	5	4	3	2	1	0
0	X'4C'							
1	LUN			0	0	0	PCR	SP
2	PC		0	0	0	0	0	0
3	0	0	0	0	0	0	0	0
4	0	0	0	0	0	0	0	0
5	0	0	0	0	0	0	0	0
6	0	0	0	0	0	0	0	0
7	Parameter List Length (MSB)							
8	Parameter List Length (LSB)							
9	0	0	0	0	0	0	0	Link

This command provides a means for an application client to manage statistical information maintained by the IDD about IDD. The INIT can know the types of statistical information and the current maintaining of each statistical information by using the LOG SENSE command.

A "Save Parameters (SP)" bit is one indicates that after performing the specified LOG SELECT operation the drive will save all parameters to the disc medium. A "SP" bit of zero specifies that parameters is not saved. It is not an error to set the "SP" bit to one and to set the DS bit of a log parameter to one. In this case, the parameter value for that log parameter is not saved.

The "Parameter Code Reset (PCR)" bit of one and a "Parameter list length" of zero cause all implemented parameters to be set to zero. It also clears the SMART Failure Warning and the Thermal Warning. If the "PCR" bit is one and the parameter list length is greater than zero, the command is terminated with CHECK CONDITION status(ILLEGAL REQUEST [=5] / INVALID FIELD IN CDB [=24-00]). In this case, the log paramters are not cleared. A PCR bit of zero specifies that the log parameters is not reset.

The "Page Control (PC)" bits specifies a kind and treatment content of parameters that changed by this command as shown below.

Value	Description
00b	Current threshold values
01b	Current cumulative values
10b	Default threshold values
11b	Default cumulative values

The "PC" bits are ignored by the drive. The drive assumes that current cumulative parameters are selected.

The "Parameter List Length" field specifies the length in bytes of the parameter list that is located in the Data-Out Buffer. If a parameter list length results in the truncation of any log parameter, the device server terminates this command with CHECK CONDITION status (ILLEGAL REQUEST [=5] / Invalid field in CDB [=24-00]).

A "Parameter List Length" of zero indicates that no pages shall be transferred. This condition shall not be considered an error.

Note:

The IDD does not support that the application client should send pages in ascending order by page code value if the Data-Out Buffer contains multiple pages.

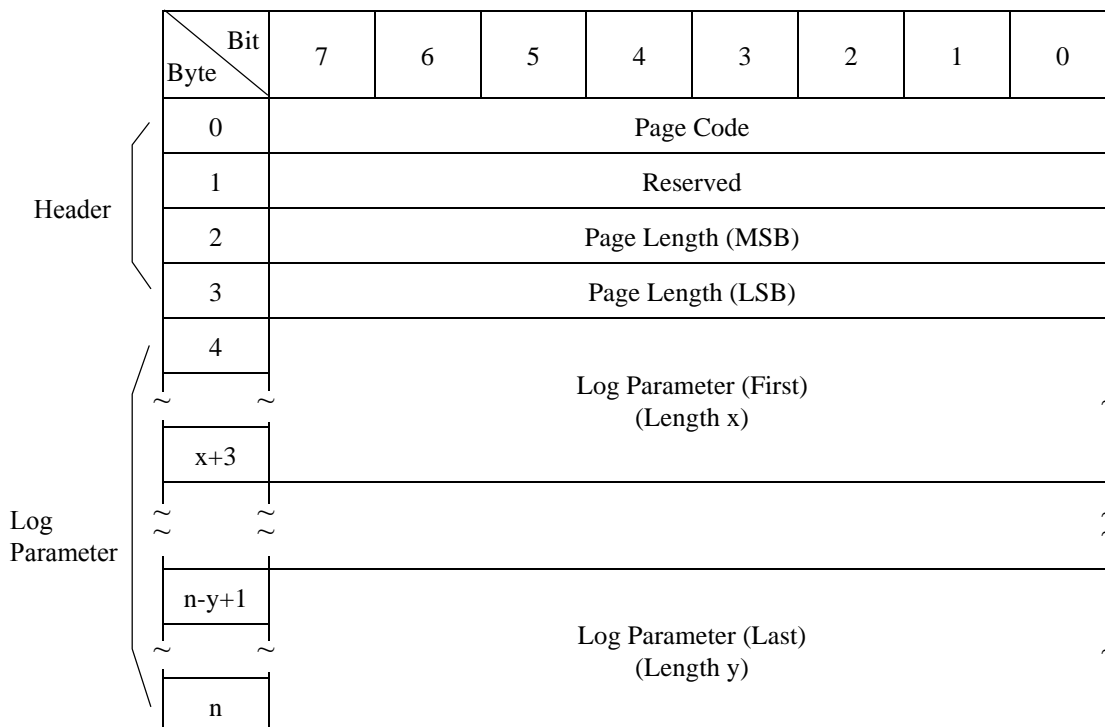

Figure 3.13 LOG, SELECT command: parameter list

(1) Page code

This field identifies which log page is being transferred.

The log pages that can be transferred by this command are shown below.

Page Code	Description	Changable Parameter
01	Buffer Overrun / Underrun Page	Disable
02	Write Error Counter Page	Enable
03	Read Error Counter Page	Enable
05	Verify Error Counter Page	Enable
06	Non-medium Error Page	Enable
0D	Tempature Page	Disable
0E	Start-stop Cycle Counter Page	Enable only 0002
0F	Application Client Log Page	Enable
10	Self-Test Result Log Page	Disable

(2) Page length

This field specifies the length in bytes of the following log parameters. If the application client sends a page length that results in the truncation of any parameter, the device server terminates the command with CHECK CONDITION status (ILLEGAL REQUEST [=5] / Invalid field in paramter list [=26-00]).

The log pages contain one or more special data structures called log parameters as shown below. Each log paramter begins with a 4-byte parameter header followed by one or more bytes of "Parameter Value" data.

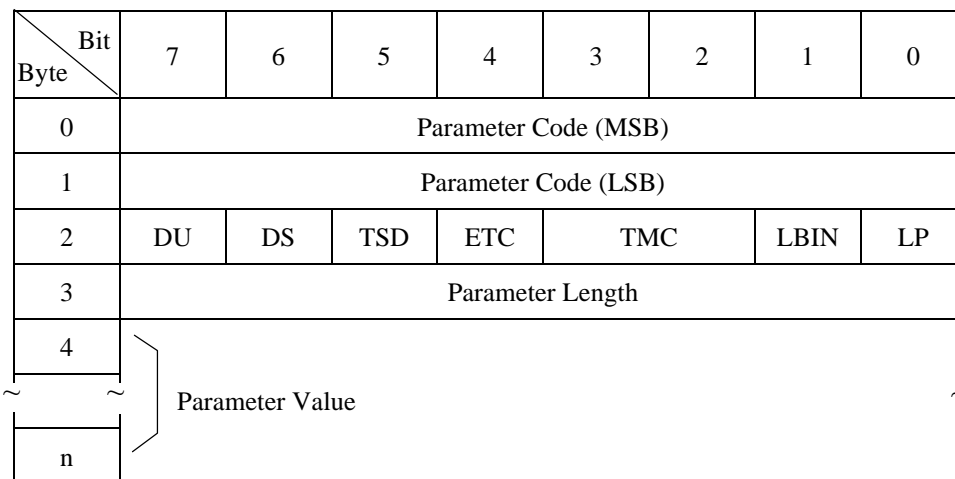

Figure 3.14 LOG SELECT command: log parameter

(1) Parameter code

This field identifies the log parameter being transferred for that log page.

(2) Byte 2

a) DU (Disable Update)

"1" : The IDD does not update the log parameter value except in response to a LOG SELECT command that specifies a new value for the parameter.

"0" : The IDD updates the log parameter value to reflect all events that are noted by that parameter.

b) DS (Disable Save)

"1" : The IDD does not support saving that log parameter in response to LOG SELECT or LOG SENSE command with an "SP" bit of one.

"0" : The IDD supports saving for that log parameter. The IDD saves the current parameter value in response to LOG SELECT or LOG SENSE command with a "SP" bit of one.

c) TSD (Target Save Disable)

The IDD does not support this bit. For LOG SENSE command (See 3.1.17), the IDD always report zero. Also, for this command, the IDD accepts this bit value of "1", but ignores its functionality.

d) ETC (Enable Threshold Comparison)

The IDD does not support this bit. For LOG SENSE command (See 3.1.17), the IDD always report zero. Also, for this command, the IDD accepts this bit value of "1", but ignores its functionality.

e) TMC (Threshold Met Criteria)

This field is ignored when "ETC" bit is 0. For LOG SELECT command (See 3.1.17), the IDD accepts this field value of other than "00b", but ignores its functionality.

f) LBIN

This bit is only valid if the "LP" bit is one. If the "LP" bit is one and this bit is zero then the list parameter is a string of ASCII graphic codes.

If the "LP" bit is one and this bit is one then the list parameter is a list of binary information.

g) LP (List Parameter)

"1" : The parameter is a data counter.

"0" : The parameter is a list parameter.

If these bits are specified by LOG SELECT command, the IDD terminates normally.

But the IDD's action is not changed.

For LOG SENSE command, these bits always report value defined in each log page (see 4.2).

(3) Parameter length

This field specifies the length in bytes of the following parameter value. If the application client sends a parameter length value that results in the truncation of the parameter value, the device server terminates the command with CHECK CONDITION status (ILLEGAL REQUEST [=5] / Invalid field in parameter list [=26-00]).

(4) Parameter value

This field indicates actual "threshold value" or "cumulative value". The size of this field differs in each log parameter.

3.1.17 LOG SENSE (4D)

Byte \ Bit	7	6	5	4	3	2	1	0
0	X'4D'							
1	LUN			0	0	0	PPC	SP
2	PC		Page Code					
3	0	0	0	0	0	0	0	0
4	0	0	0	0	0	0	0	0
5	Parameter Pointer (MSB)							
6	Parameter Pointer (LSB)							
7	Parameter List Length (MSB)							
8	Parameter List Length (LSB)							
9	0	0	0	0	0	0	0	Link

This command provides a means for the application client to retrieve statistical or other operational information maintained by the device about the device or its logical units.

The "Parameter Pointer Control (PPC)" bit is not supported. It should be zero.

An "Save Parameters (SP)" bit of zero indicates the device server performs the specified this command and does not save any log parameters. If saving log parameters is implemented, an "SP" bit of one indicates that the device server performs the specified this command and saves all log parameters identified as savable by the "DS" bit to the disc medium.

The "Page Control (PC)" field defined the type of parameter values to be selected (see 3.1.16 for the definition of the page control field).

The "PC" bits are ignored by the drive. The drive assumes that current cumulative parameters are selected.

The "Page Code" field identifies which page of data is being requested. If the page code is reserved or not implemented, the device server terminates the command with CHECK CONDITION status (ILLEGAL REQUEST [=5] / Invalid field in CDB [=24-00]).

The "Page Code" assignments for the log pages are listed below.

Page Code	Description	Parameter Pointer
00	Supported Log Pages	Ignored
01	Buffer Overrun / Underrun Page	Supported
02	Write Error Counter Page	Supported
03	Read Error Counter Page	Supported
05	Verify Error Counter Page	Supported
06	Non-medium Error Page	Should be zero
0D	Temperature Page	Supported
0E	Start-stop Cycle Counter Page	Supported
0F	Application Client Log Page	Supported
10	Self-Test Result Log Page	Supported
2F	SMART Status Page	Ignored
38	SMART Data Page	Ignored

The "Parameter Pointer" field allows the application client to request parameter data beginning from a specific parameter code to the maximum allocation length or the maximum parameter code supported by the target, whichever is less. If the value of the "Parameter Pointer" field is larger than the largest available parameter code known to the device server for the specified page, the device server terminates the command with CHECK CONDITION status (ILLEGAL REQUEST [=5] / Invalid field in CDB [=24-00]).

The "Parameter List Length" field in the CDB specifies the total number of bytes of log parameter which can be transferred to the INIT by this command. The IDD transfers the number of bytes of all log parameters specified in the "Page Code" field or the portion of log parameters with the length specified in the "Parameter List Length" field, whichever is smaller. When zero is specified in the "Parameter List Length" field, this command is terminated without anything being transferred.

3.1.18 PERSISTENT RESERVE IN (5E)

Bit Byte	7	6	5	4	3	2	1	0
0	X'5E'							
1	0	0	0	Service Action				
2	0	0	0	0	0	0	0	0
3	0	0	0	0	0	0	0	0
4	0	0	0	0	0	0	0	0
5	0	0	0	0	0	0	0	0
6	0	0	0	0	0	0	0	0
7	Allocation Length (MSB)							
8	Allocation Length (LSB)							
9	0	0	0	0	0	0	0	Link

The PERSISTENT RESERVE IN command obtains information about the reservation requirements and reservation keys that are valid in the target range. This command is used in combination with the PERSISTENT RESERVE OUT command (See Section 3.1.19).

When this command is received, if the reservation in the target is enabled by the RESERVE command, the command is rejected and is returned with the RESERVATION CONFLICT status. If the reservation is enabled by a persistent reservation, this command can be executed normally.

The length of the PERSISTENT RESERVE IN parameter data that can be returned by this command is displayed in the parameter data field. If the specified allocation length in the CDB is not sufficient for containing the entire parameter list, a portion of the parameter list from byte 0 to the specified allocation length is sent. This is not assumed to be an error. If the remaining part of the parameter must be read, the initiator must specify a value that is sufficient for containing the entire list in the Allocation Length field and issue the PERSISTENT RESERVE IN command again.

3.1.18.1 PERSISTENT RESERVE IN service actions

In a service action, nonvolatile memory in the logical unit may be required to be in the ready state to access information about reservation requirements or registration (MA*3*** series product requires the drive to be ready). If the nonvolatile memory is not ready, the drive returns the CHECK CONDITION status. The sense key is set to NOT READY [=2]. The sense data is specified with the same value returned by the TEST UNIT READY command.

The service action codes for the PERSISTENT RESERVE IN command are listed below.

Code	Name	Description
00h	READ KEYS	Reads all of the registered reservation keys.
01h	READ RESERVATIONS	Reads all of the persistent reservations that are currently enabled.
02h-1Fh	Reserved	

3.1.18.1.1 READ KEYS

In the READ KEYS service action, the drive transfers the following information to the initiator as a parameter data list.

- Current generation value (See Section 3.1.18.2)
- All of the reservation keys that are currently registered (8 bytes each)

If several initiators register the same key, the key is listed once for each registration. Therefore, the key is displayed on the list as many times as the number of initiators. (The keys are not listed in the order of their registration but in ascending order based on INIT IDs. For example, INIT ID#0 is listed first.) The keys are registered in the REGISTER service action by the PERSISTENT RESERVE OUT command.

3.1.18.1.2 READ RESERVATIONS

In the READ RESERVATION service action, the drive transfers the following information to the initiator as a parameter data list.

- Current generation value (See Section 3.1.18.2)
- Reservation keys registered by initiators that keep persistent reservations
- Scope value and type value
- Scope-specific address (only the Element scope)

When the READ RESERVATION service action is executed, if no persistent reservation is held by the drive, zero is set in the Additional Length field, which is transferred as parameter data, on the list.

3.1.18.2 PERSISTENT RESERVE IN parameter data for READ KEYS

The format for parameter data transferred in the READ KEYS service action of the PERSISTENT RESERVE IN command is shown below.

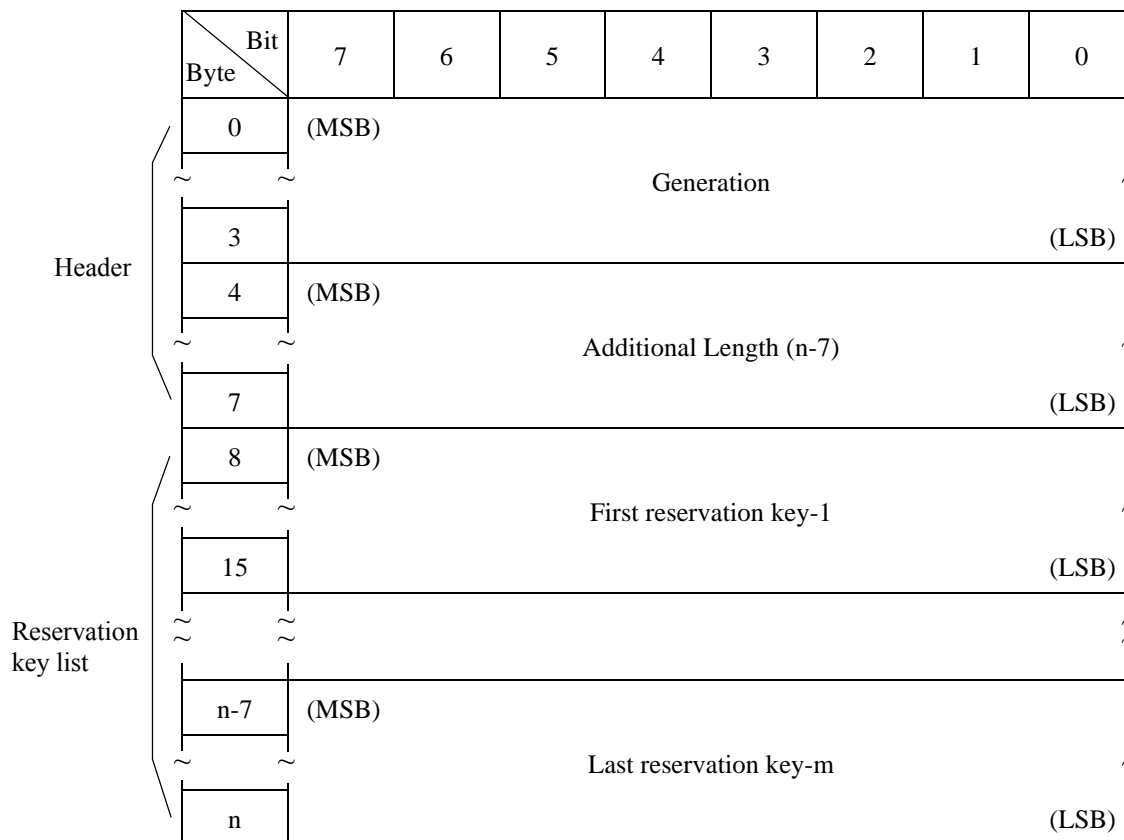

Figure 3.15 PERSISTENT RESERVE IN command: parameter data (READ KEYS)

The "Generation" field contains a 32-bit counter value maintained by the driver. This counter value is incremented every time the PERSISTENT RESERVE OUT command requests execution of the REGISTER, REGISTER AND IGNORE EXISTING KEY, CLEAR, PREEMPT, or PREEMPT AND ABORT service action.

This counter value is not incremented in the following cases:

When the PERSISTENT RESERVE IN command is executed

When the RESERVE or RELEASE service action of the PERSISTENT RESERVE OUT command is executed

If the PERSISTENT RESERVE OUT command cannot be executed because of an error or a reservation conflict. The "Generation" field is reset to zero switching the IDD's power off/on, regardless of the APTPL bit specification.

When an initiator refers to the value in the "Generation" field, a change of the configuration of that initiator associated with the logical unit can be detected without that initiator recognizing the change.

The "Additional Length" field contains a count of the number of bytes in the reservation key list. If the allocation length specified by the PERSISTENT RESERVE IN command is not sufficient for containing the entire parameter list, only a portion of the list (from byte 0 to the specified allocation length) is transferred to the initiator. If the remaining data of the list may be truncated, the "Additional Length" field displays the number of bytes of the entire reservation key list. (This is not assumed to be an error.)

The reservation key list contains the 8-byte reservation keys for all initiators that have been registered via all ports on the drive.

3.1.18.3 PERSISTENT RESERVE IN parameter data for READ RESERVATIONS

The format for the parameter data transferred in the READ RESERVATION service action of the PERSISTENT RESERVE IN command is shown below.



Figure 3.16 PERSISTENT RESERVE IN command: parameter data (READ RESERVATIONS)

The "Generation" field contains the same value defined in the parameter data field of the READ KEYS service action of the PERSISTENT RESERVE IN command (See Section 3.1.18.2).

The "Additional Length" field contains a count of the number of bytes to follow in the "Reservation Descriptors" field. If the specified allocation length in the CDB of the PERSISTENT RESERVE IN command is not sufficient for containing the entire parameter list, a portion of the parameter list from byte 0 to the specified allocation length is transferred to the initiator. If the remaining data of the list may be truncated, valid reservation descriptors are created in the "Additional Length" field.

1. The format of the PERSISTENT RESERVE IN reservation descriptors is shown below.

Byte \ Bit	7	6	5	4	3	2	1	0
0 (8)	(MSB) Reservation Key (LSB)							
7 (15)								
8 (16)	(MSB) Scope-specific Address (LSB)							
11 (19)								
12 (20)	X'00' (Reserved)							
13 (21)	Scope				Type			
14-15 (22-23)	X'00' (Reserved)							

Figure 3.17 PERSISTENT RESERVE IN Reservation Descriptor

The reservation requirements kept by a logical unit are displayed with the Reservation Descriptors in the parameter data. The Descriptors include reservation keys of the initiator that holds the reservation requirements. The Descriptors also include the "Type" value and the "Scope" value of the reservation requirements specified by the PERSISTENT RESERVE OUT command (See Sections 3.1.18.3.1 and 3.1.18.3.2).

The reservation key indicates a key registered according to the reservation requirements. If each initiator uses a unique key, the application must associate the initiator that holds the reservation requirements with the reservation key.

If "Scope" is the Element reservation, the "Scope-specific Address" field indicates an element address, where zeros are filled in the upper bytes. If the "Scope" is a logical unit reservation, the "Scope-specific Address" field shall be set to zero.

Note: MA*3*** series product does not support the Element reservation.

3.1.18.3.1 Persistent reservation scope

The value in the "Scope" field indicates that either a persistent reservation applies to an entire logical unit, or it applies part of the logical unit (element). "Scope" field values are defined below.

Code	Name	Description
0h	Logical Unit	Persistent reservation applies to an entire logical unit
1h	Reserved	Reserved
2h	Element (not supported)	Persistent reservation applies to the specified element
3h-Fh	Reserved	Reserved

3.1.18.3.1.1 Logical Unit scope

The "Scope" field value of the Logical Unit indicates that persistent reservations apply to the entire Logical Unit. All of the drives supporting PERSISTENT RESERVE OUT are required to support the scope of the Logical Unit.

3.1.18.3.1.2 Element scope (not supported by MA*3*** series product)

The "Scope" field value of the logical unit indicates that persistent reservations apply to the element of the logical unit defined in the "Scope-specific Address" field on the PERSISTENT RESERVE OUT parameter list. An element is defined with the SCSI-3 Medium Changer Commands (SMC) standard. Support of Element Scope is optional.

3.1.18.3.2 Persistent reservations type

The "Type" field value defines the reservation attributes applied to data blocks within the logical unit. Table 3.2 shows attributes for four Type values. Table 3.2 shows the code value for each Type and requirements for the supporting drive. The requirements for the supporting drive are explained in two paragraphs. The first paragraph describes the handling required for read operations. The second paragraph describes the handling required for write operations.

Table 3.2 Persistent reservation type codes

Code	Name	Description
0h	Reserved	
1h	Write Exclusive	<p>Reads Shared: Any initiator can execute read commands</p> <p>Writes Exclusive: Except by an initiator holding a persistent reservation, a write command executed by any initiator causes a reservation conflict.</p>
2h	Reserved	
3h	Exclusive Access	<p>Reads Exclusive: A read command executed by any initiator except an initiator holding a persistent reservation causes a reservation conflict.</p> <p>Writes Exclusive: A write command executed by any initiator except an initiator holding a persistent reservation causes a reservation conflict.</p>
4h	Reserved	
5h	Write Exclusive-Registrants Only	<p>Reads Shared: Any initiator can execute read commands</p> <p>Writes Exclusive: A write command executed by any initiator whose reservation key is not registered using the Register service action causes a reservation conflict.</p>
6h	Exclusive Access-Registrants Only	<p>Reads Exclusive: A read command executed by any initiator whose reservation key is not registered using the Register service action causes a reservation conflict.</p> <p>Writes Exclusive: A write command executed by any initiator whose reservation key is not registered using the Register service action causes a reservation conflict.</p>

3.1.19 PERSISTENT RESERVE OUT (5F)

Byte \ Bit	7	6	5	4	3	2	1	0
0	X'5F'							
1	0	0	0	Service Action				
2	Scope				Type			
3	0	0	0	0	0	0	0	0
4	0	0	0	0	0	0	0	0
5	0	0	0	0	0	0	0	0
6	0	0	0	0	0	0	0	0
7	Parameter List Length (18h)							
8								
9	Control							

The PERSISTENT RESERVE OUT command reserves a logical unit for exclusive or shared use by a particular initiator. This command is used in combination with the PERSISTENT RESERVE IN command. However, this command is not associated with the RESERVE or RELEASE command.

The persistent reservation conflicts with the reservation requirements specified by the RESERVE command (RESERVATION CONFLICT). The initiator defines the reservation key. The reservation key identifies the initiator that executes a service action of the PERSISTENT RESERVE OUT command. The initiator can verify which initiators have caused conflicts with the reservation requirements and which initiators hold invalid reservation requirements. If necessary, the initiator can also preempt reservation rights by issuing the PERSISTENT RESERVE OUT command.

The set reservation requirements are not reset by processing such as the TARGET RESET task. Therefore, a persistent reservation can be used for sharing a device among multiple initiators. The PERSISTENT RESERVATION OUT and PERSISTENT RESERVATION IN commands provides basic features for analyzing the dynamically changeable reservation status on a multi-initiator system using multi-port targets. These commands can identify whether a particular reservation requirement is held. They can also eliminate the requirements from an initiator that has an error or is not cooperative.

When a drive receives this command and a reservation requirement has been held by the RESERVE/RESERVE EXTEND command, the command is rejected and returned with the RESERVATION CONFLICT status.

When this command is issued, if an invalid drive resource exists, the drive returns the "CHECK CONDITION" status. The sense key is set to ILLEGAL REQUEST [=5]. Sense data is set to INSUFFICIENT REGISTRATION RESOURCES [=55-04].
(However, SCSI devices do not report sense information.)

The RESERVE, PREEMPT, and PREEMPT AND ABORT service actions of this command determine whether any conflict of Scope or Type specifications occurs between two reservation requirements: the new one provided by this command, and the other one already being held on the drive. If the reservation requirements conflict, the command is rejected and returned with the RESERVATION CONFLICT status. In this case, RESERVE, PREEMPT, and CLEAR processing is not executed. However, if the reservation requirement held by an initiator is preempted (specified by the service action reservation key) in the RESERVE, PREEMPT, or PREEMPT AND ABORT service action, the reservation requirement is excluded from the conflict determination.

The RELEASE and CLEAR service actions do not conflict with any reservation requirements. (However, if a reservation key is not registered, or if a reservation key does not match the reserved one, it returns the RESERVATION CONFLICT status.)

If an initiator that does not register a reservation key issues this command specified with a service action other than REGISTER or REGISTER AND IGNORE EXISTING KEY, the command is rejected and returned with the RESERVATION CONFLICT status.

The PERSISTENT RESERVE OUT command includes fields for specifying the type of PERSISTENT RESERVATION service action, the applied Scope of a persistent reservation, and the restrictions defined by a persistent reservation. For definitions of "Type" and "Scope" fields, see Sections 3.1.18.3.1 and 3.1.18.3.2. If the specified Scope value cannot be executed on the device, the drive returns the "CHECK CONDITION" status. The sense key is set to ILLEGAL REQUEST [=5], and sense data is set to INVALID FIELD IN CDB [=24-00].

In fields on the PERSISTENT RESERVE OUT parameter list, information about the reservation key and elements that are required for executing the PERSISTENT RESERVATION service action is specified.

The parameter list is 24 bytes in length so the "Parameter List Length" field must contain "24 (18h)." If the parameter list length is not "24 (18h)," the drive returns the CHECK CONDITION status. Moreover, the sense key is set to ILLEGAL REQUEST [=5], and the sense data is set to PARAMETER LIST LENGTH ERROR [=1A-00].

A logical unit uses nonvolatile memory to maintain persistent reservations and the registered keys (even after unit power is turned off). (The AL-7 series product uses the SA space.) If the nonvolatile memory is in the access-disabled state when the Active Persist Through Power Loss facility is enabled (to maintain reservation requirements after unit power is turned off) by issuing the PERSISTENT RESERVE OUT command, the drive returns the CHECK CONDITION status. The sense key is set to NOT READY [=2], and sense data is set as defined in the TEST UNIT READY command.

3.1.19.1 PERSISTENT RESERVE OUT service actions

To execute a service action of the PERSISTENT RESERVE OUT, the drive updates the "Generation" value as described in the Section 3.1.18.

Table 3.3 describes the service actions of the PERSISTENT RESERVE OUT command.

Table 3.3 PERSISTENT RESERVE OUT command service action codes

Code	Name	Description
00h	REGISTER	Registers a reservation key on the drive.
01h	RESERVE	Generates a persistent reservation for the specified Scope and Type using the reservation key.
02h	RELEASE	Releases the persistent reservation.
03h	CLEAR	Clears all reservation keys and persistent reservations.
04h	PREEMPT	Dispossesses a persistent reservation from another initiator.
05h	PREEMPT & ABORT	Dispossesses a persistent reservation from another initiator, and clears the task set regarding the initiator.
06h	REGISTER & IGNORE EXISTING KEY	Registers a reservations key on the drive.
07h-1Fh	Reserved	

3.1.19.2 PERSISTENT RESERVE OUT parameter list

The format for the parameter list that is transferred with the PERSISTENT RESERVE OUT command is shown below. Some fields on the parameter list may be disabled for specific service actions or a specific Scope. However, all fields including such fields must be transferred by this command.

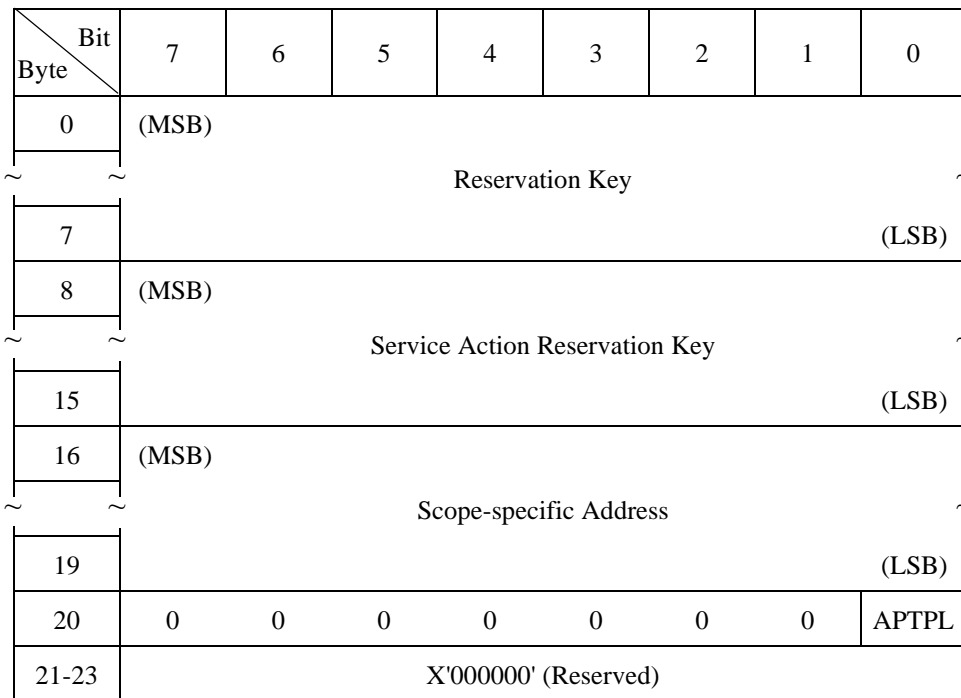

Figure 3.18 PERSISTENT RESERVE OUT command: parameter list

For the "Reservation Key" field, an 8-byte key code provided by the application client is set in order to enable the drive to identify the initiator that is the source of the PERSISTENT RESERVE OUT command. The drive can then verify that the "Reservation Key" field in the PERSISTENT RESERVE OUT command matches the registered reservation key for the initiator that issues the command. However, if the reservation key value is zero, which means no reservation key is registered, the specified value in this field is ignored. If the key specified for the PERSISTENT RESERVE OUT command does not match the registered reservation key for the initiator, the drive returns the RESERVATION CONFLICT status. This reservation key of the initiator is valid to all service actions and Scopes.

The "Service Action Reservation Key" field must be specified for the REGISTER, PREEMPT, and PREEMPT AND ABORT service actions. In the REGISTER service action, a new registered reservation key is specified in this field. In the PREEMPT and PREEMPT AND ABORT service actions, a reservation key of the initiator that holds the reservation requirements to be preempted is specified in this field. In the PREEMPT or PREEMPT AND ABORT service actions, if the value specified in this field does not match any registered reservation key, the drive returns the RESERVATION CONFLICT status. In other service actions, the value specified in this field is ignored.

If the Scope is the Element reservation, the "Scope-specific Address" field contains the Element address, zero filled in the most significant bytes to fit the field. If the service action is REGISTER, REGISTER AND IGNORE EXISTING KEY, or CLEAR, or if the Scope is a Logical Unit reservation, the "Scope-specific Address" field is set to zero.

The "Activate Persist Through Power Loss (APTPL)" bit shall be valid only for the REGISTER service action. In any other service action, the APTPL bit is ignored. Support for the APTPL bit is optional. If a value is specified for a drive that does not support the APTPL bit, the drive returns the CHECK CONDITION status and terminates this command. In this case, the sense key is set to ILLEGAL REQUEST [=5], and sense data is set to INVALID FIELD IN PARAMETER LIST [=26-00].

If the last APTPL bit value received by the driver is zero, all persistent reservations are released and all reservation keys are cleared by turning off the power to the target (See Section 4.2.1.1). If the last APTPL bit value received by the driver is one, the logical unit keeps all persistent reservations and reservation keys for all initiators even after unit power is turned off once and turned on again. (MA*3*** series product saves the registration information in the SA space.) The APTPL value controls the operation of the logical unit while power is off, and it is always valid even if it is received from an initiator.

Table 3.4 summarizes which fields are defined by the application client and interpreted by the drive for each service action and scope value. The reservation keys and APTPL are explained in previous sections.

Table 3.4 PERSISTENT RESERVE OUT service actions and valid parameters

Service Action	Allowed Scope	Parameters			
		type	Reservation Key	Service Action Reservation Key	Element Parameters
REGISTER	ignored	ignored	valid	valid	ignored
REGISTER & IGNORE EXISTING KEY	LU	ignored	ignored	valid	ignored
	Element	ignored	ignored	valid	valid (*1)
RESERVE	LU	valid	valid	ignored	ignored
	Element	valid	valid	ignored	valid (*1)
RELEASE	LU	valid	valid	ignored	ignored
	Element	valid	valid	ignored	valid (*1)
CLEAR	ignored	ignored	valid	ignored	ignored
PREEMPT	LU	valid	valid	valid	ignored
	Element	valid	valid	valid	valid (*1)
PREEMPT & ABORT	LU	valid	valid	valid	ignored
	Element	valid	valid	valid	valid (*1)

Note: MA*3*** series product does not support the Element scope.

3.1.20 REPORT LUNS (A0)

Byte \ Bit	7	6	5	4	3	2	1	0
0	X'A0'							
1	0	0	0	0	0	0	0	0
2	0	0	0	0	0	0	0	0
3	0	0	0	0	0	0	0	0
4	0	0	0	0	0	0	0	0
5	0	0	0	0	0	0	0	0
6	Allocation Length (MSB)							
7	Allocation Length							
8	Allocation Length							
9	Allocation Length (LSB)							
10	0	0	0	0	0	0	0	0
11	0	0	0	0	0	0	0	Link

This command requests that the peripheral device logical unit inventory be sent to the application client.

This command normally operate under the reserve condition (RESERVE or PERSISTENT RESERVE).

The "Allocation Length" should be at least 16 bytes. If the "Allocation Length" is less than 16 bytes, the IDD reports the CHECK CONDITION status (ILLEGAL REQUEST [=5] / Invalid Field in CDB [=24-00]). If the "Allocation Length" is not sufficient to contain the entire logical unit inventory, the device server shall report as many logical unit number values as fit in the specified allocation length. This shall not be considered an error.

The device server shall report those devices in the logical unit inventory using the format shown in below.

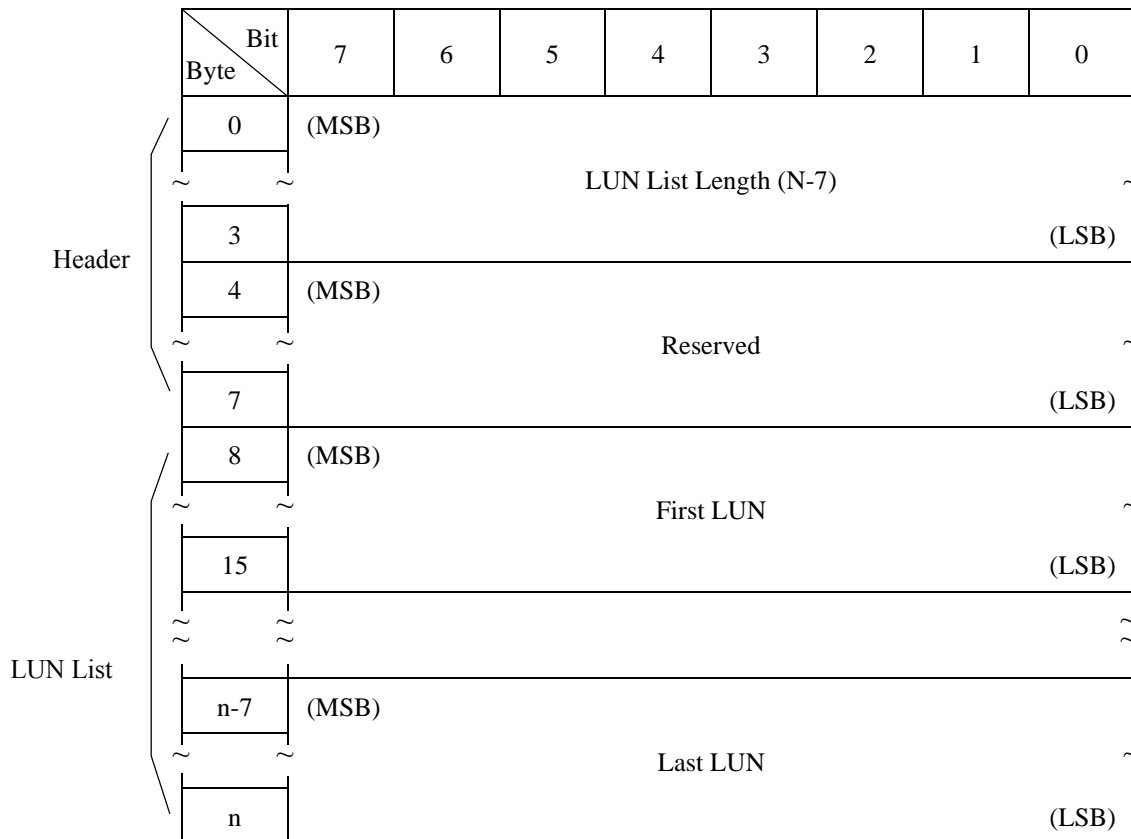

Figure 3.19 REPORT LUNS command: parameter list

The "LUN List Length" field shall contain the length in bytes of the LUN list that is available to be transferred. The "LUN list length" is the number of logical unit numbers in the logical unit inventory multiplied by eight. If the allocation length in the command descriptor block is too small to transfer information about the entire logical unit inventory, the LUN list length value shall not be adjusted to reflect the truncation.

3.1.21 REPORT DEVICE IDENTIFIER (A3)

Byte \ Bit	7	6	5	4	3	2	1	0
0	X 'A3'							
1	0	0	0	Service Action (X' 05')				
2	0	0	0	0	0	0	0	0
3	0	0	0	0	0	0	0	0
4	0	0	0	0	0	0	0	0
5	0	0	0	0	0	0	0	0
6	Allocation Length (MSB)							
7	Allocation Length							
8	Allocation Length							
9	Allocation Length (LSB)							
10	0	0	0	0	0	0	0	0
11	0	0	0	0	0	0	0	Link

This command requests that the device server send device identification information to the application client.

The "Service Action" field can be specified only X'05'.

The "Allocation Length" field indicates how much space has been reserved for the returned parameter data. If the length is not sufficient to contain all the parameter data, the first portion of the data shall be returned. This shall not be considered an error. The actual length of the parameter data is available in the "Identifier Length" field in the parameter data. If the remainder of the parameter data is required, the application client should send a new REPORT DEVICE IDENTIFIER command with an "Allocation Length" field large enough to contain all the data.

The REPORT DEVICE IDENTIFIER parameter list are shown below.



Figure 3.20 REPORT DEVICE IDENTIFIER: parameter list

The "Identifier Length" field specifies the length in bytes of the "Identifier" field.

If the "Allocation Length" field in the CDB is too small to transfer all of the identifier, the length shall not be adjusted to reflect the truncation. The identifier length shall initially equal zero, and shall be changed only by a successful SET DEVICE IDENTIFIER command.

The "Identifier" field shall contain a vendor specific value. The value reported shall be the last value written by a successful SET DEVICE IDENTIFIER command. The value of the identifier shall be changed only by a SET DEVICE IDENTIFIER command. The identifier value shall persist through resets, power cycles, media format operations, and media replacement.

The target shall return the same Identifier to all initiators on all ports.

The execution of a REPORT DEVICE IDENTIFIER may require the enabling of a nonvolatile memory within the logical unit. If the nonvolatile memory is not ready, the device server shall return CHECK CONDITION status, rather than wait for the device to become ready. The sense key shall be set to NOT READY and the additional sense data shall be set as described in the TEST UNIT READY command.

3.1.22 SET DEVICE IDENTIFIER (A4)

Byte \ Bit	7	6	5	4	3	2	1	0
0	X'A4'							
1	0	0	0	Service Action (X'06')				
2	0	0	0	0	0	0	0	0
3	0	0	0	0	0	0	0	0
4	0	0	0	0	0	0	0	0
5	0	0	0	0	0	0	0	0
6	Allocation Length (MSB)							
7	Allocation Length							
8	Allocation Length							
9	Allocation Length (LSB)							
10	0	0	0	0	0	0	0	0
11	0	0	0	0	0	0	0	Link

This command requests that the device identifier information in the logical unit be set to the value received in the SET DEVICE IDENTIFIER parameter list.

On successful completion of this command a unit attention shall be generated for all initiators except the one that issued the service action. When reporting the unit attention condition the additional sense code shall be set to DEVICE IDENTIFIER CHANGED.

The "Service Action" field can be specified only X'06'.

The "Allocation Length" field specifies the length in bytes of the Identifier that shall be transferred from the application client to the device server. The maximum value for this field shall be 512 bytes. A parameter list length of zero indicates that no data shall be transferred, and that subsequent REPORT DEVICE IDENTIFIER commands shall return an Identifier length of zero. Logical units that implement this command shall be capable of accepting a parameter list length of 512 bytes or less. If the parameter list length exceeds 512 bytes and the logical unit is not capable of storing the requested number of bytes, then the device server shall return CHECK CONDITION status (ILLEGAL REQUEST [=5] / Invalid field in CDB [=24-00]).

The SET DEVICE IDENTIFIER parameter list are shown below.

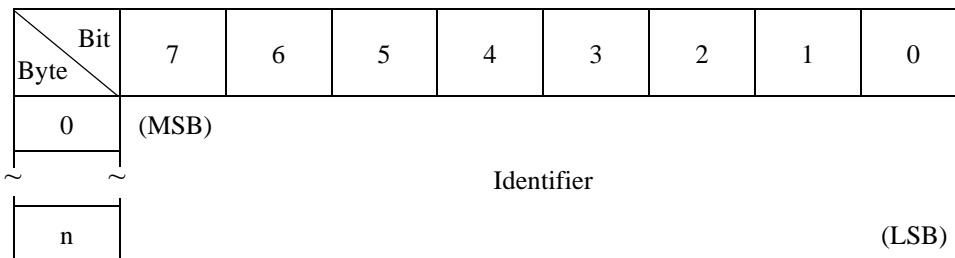

Figure 3.21 SET DEVICE IDENTIFER: parameter list

The "Identifier" field shall be a vendor specific value, to be returned in subsequent REPORT DEVICE IDENTIFIER commands.

3.2 Data Access Commands

3.2.1 READ (08)

Byte \ Bit	7	6	5	4	3	2	1	0
0	X'08'							
1	LUN			Logical Block Address (MSB)				
2	Logical Block Address							
3	Logical Block Address (LSB)							
4	Transfer Block Count							
5	0	0	0	0	0	0	0	Link

This command reads the number of blocks of data in continuous logical data blocks specified in the "Transfer block count" field with the logical data block on the disk media specified in the "Logical block address" field in the CDB as the top.

The transfer block count can be specified up to a maximum of 256 logical data blocks. When zero is specified in the "Transfer block count" field in byte 4 of the CDB, it specifies transfer of 256 logical data blocks and when a value other than zero is specified, it specifies the number of logical data blocks that should be transferred.

When transfer of multiple data blocks is instructed by this command, when the data blocks which are to be processed come to a track boundary, cylinder boundary or zone boundary, a head switch or cylinder switch is executed automatically and reading of the specified number of blocks is performed.

When the specifications in the "Logical block address" field and "Transfer block count" field in the CDB exceed the maximum logical block address in the IDD, that command is terminated with a CHECK CONDITION status (ILLEGAL REQUEST [=5] / Logical block address out of range [=21-00]) and the reading of data from the disk media is not executed.

Error recovery processing during execution of this command can be specified by the MODE SELECT parameter. If retry processing and data correction processing are not prohibited, when this command is completed normally, or when it is completed with a "RECOVERED ERROR [=1]" sense key report, the data transferred to the INIT by this command are error free. When a correctable error check is detected, the IDD first corrects the data errors in the data buffer, then transfers those data to the INIT.

When disconnect processing is permitted, the starting timing for reconnection processing in order to execute data transfer on the SCSI bus can be specified by the MODE SELECT parameter (buffer full ratio). Also, if the Look-Ahead cache feature is permitted, a caching operation is performed using the IDD's data buffer by this command. See Chapter 2, "Data Buffer Management," concerning details of data buffer operation and the Look-Ahead cache feature.

3.2.2 READ EXTENDED (28)

Byte \ Bit	7	6	5	4	3	2	1	0
0	X'28'							
1	LUN			×	FUA	0	0	0
2	Logical Block Address (MSB)							
3	Logical Block Address							
4	Logical Block Address							
5	Logical Block Address (LSB)							
6	0	0	0	0	0	0	0	0
7	Transfer Block Count (MSB)							
8	Transfer Block Count (LSB)							
9	0	0	0	0	0	0	0	Link

This command reads the number of blocks of data in continuous logical data blocks specified in the "Transfer block count" field with the logical data block on the disk media specified in the "Logical block address" field in the CDB as the top.

The functions of this command are the same as those of the Group 0 READ command (Section 3.2.1) with the exception that it is possible to specify 4-byte logical block addresses and 2-byte transfer block counts. However, when zero is specified for the "Transfer block count," the command is terminated normally without seek and pre-fetch being performed.

- FUA (force unit access)

When this bit is "0", it indicates that the IDD satisfy the command by accessing the cache memory. Any logical blocks that are contained in the cache memory may be transferred to the INIT directly from the cache memory.

When this bit is "1", it indicated that the IDD shall access the media in performing the command prior to returning GOOD status. READ commands shall access the specified logical blocks from the media (i.e., the data is not directly retrieved from the cache).

3.2.3 WRITE (0A)

Byte \ Bit	7	6	5	4	3	2	1	0
0	X'0A'							
1	LUN			Logical Block Address (MSB)				
2	Logical Block Address							
3	Logical Block Address (LSB)							
4	Transfer Block Count							
5	0	0	0	0	0	0	0	Link

This command transfers the number of blocks of data specified in the "Transfer block count" field from the INIT and writes them in continuous logical data blocks with the logical data block on the disk media specified in the "Logical block address" field in the CDB as the top.

The transfer block count can be specified up to a maximum of 256 logical data blocks. When zero is specified in the "Transfer block count" field in byte 4 of the CDB, it specifies transfer of 256 logical data blocks and when a value other than zero is specified, it specifies the number of logical data blocks that should be transferred.

When transfer of multiple data blocks is instructed by this command, when the data blocks which are to be processed come to a track boundary, cylinder boundary or zone boundary, a head switch or cylinder switch is executed automatically and writing of the specified number of blocks is performed.

When the specifications in the "Logical block address" field and "Transfer block count" field in the CDB exceed the maximum logical block address in the IDD, that command is terminated with a CHECK CONDITION status (ILLEGAL REQUEST [=5] / Logical block address out of range [=21-00]) and writing of data to the disk media is not executed.

The IDD does not perform data transfer immediately after receiving the CDB, but after performing automatic disconnect processing once, it executes pre-fetching of data. If disconnect processing is permitted, the IDD either completes transfer of all the data specified in the command or, at the point when the empty space in the data buffer runs out, disconnect processing is executed. Positioning of the specified data blocks is performed in parallel with this data transfer, and writing of data from the data buffer to the disk media is executed immediately after positioning is completed. See Section 2.1 "Data Buffer" for details of data buffer operation and control of the timing for starting reconnection processing by the MODE SELECT parameter (buffer empty ratio).

If the write cache function is enabled, the IDD reports a status at the point when reception of all the data transferred from the INIT is completed. If an error occurs while data are being written to the disk media, a CHECK CONDITION status is reported for the command to be executed next. If the write cache function is disabled, a status is reported after writing to the disk media of all the data transferred from the INIT is completed, then execution of the command is terminated.

Note:

Even when there is an error in the specification in the CDB, or when a write operation to the disk media cannot be executed normally due to various other causes, the transfer of data (data is pre-fetched to the data buffer) from the INIT to the IDD may be executed. In this case, the length of data transferred from the INIT to the IDD is undefined. Also, all the data transferred to the IDD will not necessarily be actually written to the disk media. However, if the command is terminated with a CHECK CONDITION status and the sense key of the sense data indicates "ILLEGAL REQUEST [=5]," the data from that command is not written to the disk media by a write operation.

3.2.4 WRITE EXTENDED (2A)

Byte \ Bit	7	6	5	4	3	2	1	0
0	X'2A'							
1	LUN			×	FUA	0	0	0
2	Logical Block Address (MSB)							
3	Logical Block Address							
4	Logical Block Address							
5	Logical Block Address (LSB)							
6	0	0	0	0	0	0	0	0
7	Transfer Block Count (MSB)							
8	Transfer Block Count (LSB)							
9	0	0	0	0	0	0	0	Link

This command transfers the number of blocks of data specified in the "Transfer block count" field from the INIT and writes them in continuous logical data blocks with the logical data block on the disk media specified in the "Logical block address" field in the CDB as the top.

The functions of this command are the same as those of the Group 0 WRITE command (Section 3.2.3) with the exception that it is possible to specify 4-byte logical block addresses and 2-byte transfer block counts. However, when zero is specified for the "Transfer block count," the command is terminated normally without pre-fetch being performed.

- FUA (force unit access)

When this bit is "0", it indicates that the IDD satisfy the command by accessing the cache memory. For write operations, logical blocks may be transferred directly to the cache memory. GOOD status may be returned to the INIT prior to writing the logical blocks to the medium. Any error that occurs after the GOOD status is returned is a deferred error and information regarding the error is not reported until a subsequent command.

When this bit is "1", it indicated that the IDD shall access the media in performing the command prior to returning GOOD status. WRITE commands shall not return GOOD status until the logical blocks have actually been written on the media (i.e., the data is not write cached).

3.2.5 WRITE AND VERIFY (2E)

Byte \ Bit	7	6	5	4	3	2	1	0
0	X'2E'							
1	LUN			×	0	0	BytChk	0
2	Logical Block Address (MSB)							
3	Logical Block Address							
4	Logical Block Address							
5	Logical Block Address (LSB)							
6	0	0	0	0	0	0	0	0
7	Transfer Block Count (MSB)							
8	Transfer Block Count (LSB)							
9	0	0	0	0	0	0	0	Link

This command transfers the number of blocks of data specified in the "Transfer block count" field from the INIT and writes them in continuous logical data blocks with the logical data block on the disk media specified in the "Logical block address" field in the CDB as the top, then reads those data and performs a Verify check.

The functions of this command related to write operations are the same as those of the WRITE EXTENDED command (Section 3.2.4), with the exception that the write cache function cannot be applied. When zero is specified in the "Transfer block count," this command is terminated normally without performing seek or pre-fetch.

The specification in bit 4 of CDB byte 1 is disabled in the IDD and the specified value is disregarded.

The VERIFY check executed by this command is the only the ECC (data portion) normalcy check. Error recovery processing during execution of the VERIFY check conforms to the mode specified by the MODE SELECT parameter (Verify error recovery parameter). For example, when data correction processing is not prohibited, if a correctable data check is detected during the VERIFY check, the VERIFY check is regarded as having terminated successfully.

When "1" is set in bit 1 (BytChk bit) of CDB byte 1, the IDD reads data blocks from the disk and compares the data with the write data transferred from the INIT after terminating the write operation. This IDD does not support that function, however, so it performs the operation executed when "0" is set in bit 1 (BytChk bit) of CDB byte 1.

3.2.6 VERIFY (2F)

Byte \ Bit	7	6	5	4	3	2	1	0
0	X'2F'							
1	LUN			×	0	0	BytChk	0
2	Logical Block Address (MSB)							
3	Logical Block Address							
4	Logical Block Address							
5	Logical Block Address (LSB)							
6	0	0	0	0	0	0	0	0
7	Transfer Block Count (MSB)							
8	Transfer Block Count (LSB)							
9	0	0	0	0	0	0	0	Link

This command reads the number of continuous logical data blocks specified in the "Block count" field with the logical data block on the disk media which is specified in the "Logical block address" field in the CDB as the top, then executes a VERIFY check on those data.

The "Block count" field in the CDB specifies the number of data blocks which is the object of the VERIFY check. When zero is specified in the "Transfer block count," the command is terminated normally without performing seek and pre-fetch.

Bit 4 of CDB byte 1 is disabled in the IDD and the specified value is disregarded.

If "1" is specified in bit 1 of CDB byte 1, the BytChk bit, the IDD compare the data read from the disk media with the data transferred from the INIT. If the data do not match during this mode, the command is terminated with a CHECK CONDITION status (MISCOMPARE [=E] / Miscompare during verify operation [=1D-00]).

If "0" is specified in bit 1 of CDB byte 1, the BytChk bit, an ECC (data portion) normalcy check is executed. Also, error recovery processing during execution of the verify check is according to the mode specified by the MODE SELECT parameter (verify error recovery parameter). For example, if data correction processing is not prohibited, even if a correctable data check is detected, it is regarded as if the verify check succeeded.

3.2.7 SEEK (0B)

Byte \ Bit	7	6	5	4	3	2	1	0
0	X'0B'							
1	LUN			Logical Block Address (MSB)				
2	Logical Block Address							
3	Logical Block Address (LSB)							
4	0	0	0	0	0	0	0	0
5	0	0	0	0	0	0	0	Link

This command executes a seek operation of the cylinder/track where the logical data block specified in the "Logical block address" field in the CDB exists.

When disconnect processing is permitted, the IDD performs disconnect processing after receiving the CDB. After that, the IDD executes reconnect processing at the point when the seek operation is completed and reports the status.

When disconnect processing is not permitted, the IDD executes the seek operation while still connected to the SCSI bus and when it is completed, reports the status of this command.

3.2.8 SEEK EXTENDED (2B)

Byte \ Bit	7	6	5	4	3	2	1	0
0	X'2B'							
1	LUN			0	0	0	0	0
2	Logical Block Address (MSB)							
3	Logical Block Address							
4	Logical Block Address							
5	Logical Block Address (LSB)							
6	0	0	0	0	0	0	0	0
7	0	0	0	0	0	0	0	0
8	0	0	0	0	0	0	0	0
9	0	0	0	0	0	0	0	Link

This command executes a seek operation of the cylinder/track where the logical data block specified in the "Logical block address" field in the CDB exists.

The functions and operation of this command are the same as those of the Group 0 SEEK command (Section 3.2.7), except that it is possible to specify 4-byte logical block addresses.

3.2.9 SET LIMITS (33) (Not Supported)

Byte \ Bit	7	6	5	4	3	2	1	0
0	X'33'							
1	LUN			0	0	0	RdInh	WrInh
2	Logical Block Address (MSB)							
3	Logical Block Address							
4	Logical Block Address							
5	Logical Block Address (LSB)							
6	0	0	0	0	0	0	0	0
7	Transfer Block Count (MSB)							
8	Transfer Block Count (LSB)							
9	0	0	0	0	0	0	0	Link

This command specifies the address range of logical data blocks on an ID which it is possible to access by commands which follow this command and which are linked to it, and to specify the type of operations which it is possible to execute. It is possible to issue this command once only in a group of commands which are linked in a series.

Note:

The specifications in this command are valid only for a series of linked commands which follow this command. When the link between the commands is cut, the specifications in this command lose their validity.

The "Logical block address" field in the CDB specifies the logical block address which is the starting point of the range where access is permitted. When an address in the User Space (X '00000000' or higher) is specified in the "Logical block address" field, access to the User Space only is permitted in linked commands which follow this command and CE space cannot be accessed. On the other hand, if an address in CE space (X '80000000' or higher) is specified, access to CE space only is permitted in linked commands which follow this command, and User Space cannot be accessed.

Also, the size of the range where access is permitted, specified in this command in the "Block count" field in the CDB, specifies the number of logical data blocks from that starting point. However, when zero is specified in the "Block count" field, access to the final logical data block of the specified data space (User Space or CE Space), with the logical data block specified in the "Logical block address" field as the starting point, is permitted. Figure 3.22 shows the method for specification of the range where access is permitted in this command.

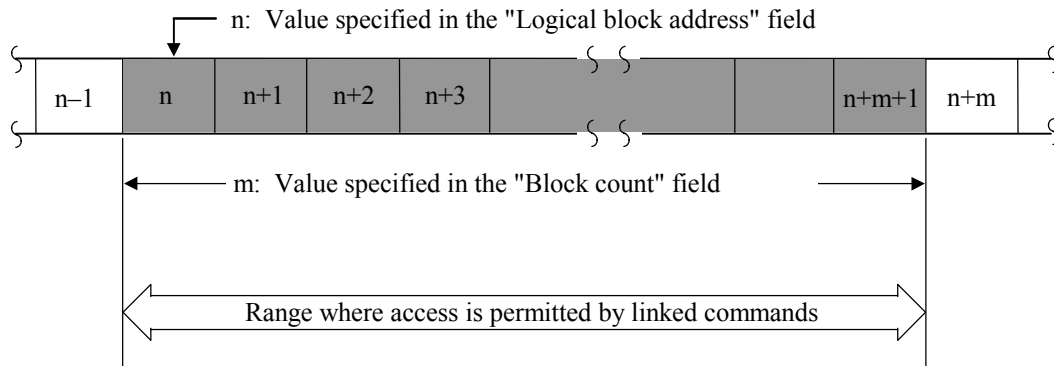

Figure 3.22 SET LIMITS command: Specifying the range where access is permitted

If "1" is specified in bit 1 of CDB byte 1, "RdInh (read inhibit)" flag or in bit 0, "WrInh (write inhibit)" flag, read operations or write operations is prohibited for linked commands following this command, as shown below.

RdInh	WrInh	Operation limits
0	0	Read/write operations are permitted in the specified range.
0	1	Read operations only are permitted in the specified range.
1	0	Write operations only are permitted in the specified range.
1	1	Both read and write operations are prohibited. Only access by the SEEK and SEEK EXTENDED commands is permitted within the specified range.

When access to logical data blocks outside the address range defined by this command by linked commands which follow this command is specified, or when a prohibited type of access operation is specified, that command is terminated with a CHECK CONDITION status without being executed. (When there is a violation of the (DATA PROTECT [=7] / Write protect [=27-00]: "WrInh" flag, or when there is a violation of the (DATA PROTECT [=7] / No additional sense information [=00-00]: "RdInh" flag.) When this command is issued again in a group of commands linked in a series, the 2nd SET LIMITS command is rejected and a CHECK CONDITION status (DATA PROTECT [=7] / Command sequence error [=2C-00]) is reported.

Notes:

1. Commands which come under restrictions in read operations or write operations when "1" is specified in the "RdInh" (read inhibit) or "WrInh" (write inhibit) flag are as follows.
 - “RdInh” • READ
 - VERIFY (*)
 - READ EXTENDED (*) • WRITE AND VERIFY (*)
 - READ LONG • PRE-FETCH
 - “WrInh” • FORMAT UNIT
 - WRITE EXTENDED (*)
 - REASSIGN BLOCKS • WRITE LONG
 - WRITE • WRITE SAME
 - WRITE AND VERIFY (*)

* When zero is specified in the processing block count, that command is not executed.
2. Even if a write operation is prohibited by this command, "0" is indicated in the "WP (write protect)" bit reported to the INIT in the MODE SENSE and MODE SENSE EXTENDED commands.
3. If "0" is specified in this command in the "WrInh" flag, execution of a FORMAT UNIT command or REASSIGN BLOCKS command issued in linked form following this command is permitted (the specification of the range where access is permitted is not applied.)

3.2.10 SYNCHRONIZE CACHE (35)

Byte \ Bit	7	6	5	4	3	2	1	0
0	X'35'							
1	LUN			0	0	0	Immed	0
2	Logical Block Address (MSB)							
3	Logical Block Address							
4	Logical Block Address							
5	Logical Block Address (LSB)							
6	0	0	0	0	0	0	0	0
7	Block Count (MSB)							
8	Block Count (LSB)							
9	0	0	0	0	0	0	0	Link

This command matches the logical block data in the data buffer with the same logical block data recorded on the disk media. If the data in the logical block in the data buffer is newer than the data on the disk media, those data are written to the disk media.

When the write cache is used, unwritten data held in the data buffer which are written to the disk media are written using this command.

The values specified in the "Logical block address" field and "Block count" field in the CDB are disregarded and if any unwritten data exist in the data buffer, writing of all those data to the disk media is performed.

If bit 1 of CDB byte 1, the "Immed (immediate) bit, is "1," a GOOD status is reported immediately at the point when the legality of the CDB is confirmed and the command is terminated. If this bit is "0," a GOOD status is reported at the point when writing of the unwritten data in the data buffer is completed and the command is terminated.

3.3 Format Commands

3.3.1 FORMAT UNIT (04)

Byte \ Bit	7	6	5	4	3	2	1	0
0	X'04'							
1	LUN			FmtData	CmpLst	Defect List Format		
2	0	0	0	0	0	0	0	0
3	Interleave factor (MSB)							
4	Interleave factor (LSB)							
5	0	0	0	0	0	0	0	Link

This command initializes (formats) the entire area of the disk media that can be accessed from the INIT (User Space). At the same time, the IDD also implements defect management processing, allocating alternate blocks for defective portions of the disk media in accordance with the specifications in this command.

Furthermore, when the disk media is initialized with any of the following format attributes changed, the INIT must issue the MODE SELECT or MODE SELECT EXTENDED command before issuing this command and specify those format attributes in advance.

- Logical data block length
- Logical data block count
- User space cylinder count
- Spare sector count for alternate blocks

(1) Defect list

In order to register or specify the positions of defects on the disk media in connection with defect management processing that can be specified from the INIT, the following types of “Defect List” are defined.

a. P List: primary defect list

Defect position information (permanent defects) is registered in this list at the time the disk drive is shipped from the factory. The P List registers areas on the disk media which clearly cannot be accessed from the INIT. The INIT can refer to the contents of this list by the READ DEFECT DATA command only, but cannot change or erase it.

b. D List: data defect list

The defect information in this list is defect position information transferred from the INIT when this command is executed. The IDD registers this defect information on the disk media as the G List.

c. C List: target certification list

This defect list contains position information on defective data blocks detected in the data block verify operation (Certification) after initialization when the FORMAT UNIT command is executed. The IDD generates this list internally when the FORMAT UNIT command is executed and adds it to the G List.

d. G List: grown defect list

The defect information in this list contains defect position information specified by the NIT and position information on defective data blocks detected by the IDD itself. The P List is not included in this defect list. The IDD stores the G List in an area on the disk media which clearly cannot be accessed from the INIT. The INIT can refer to the contents of this list by the READ DEFECT DATA command. the following defect position information is included in the G List.

- Defect information transferred from the INIT as the D List.
- Defect information detected in the Verify operation when this command was executed (C List)
- Defect information specified from the INIT by the REASSIGN BLOCKS command.
- Defect information on data blocks where alternate block allocation was performed among defective data blocks detected by the IDD when automatic allocation processing of alternate blocks is permitted.

(2) Specifying the initialization method

The INIT can specify the method of defect processing executed by this command in the “FmtData (format data)” bit and “CmpLst (complete list)” bit of CDB byte 1 and the “Defect List Format” field.

When “1” is specified in the “FmtData (format data)” bit, it indicates that the format parameters (header and defect list), described later, are transferred from the INIT when this command is executed. When this bit’s specification is “0,” it indicates that the format parameters are not transferred.

When the “CmpLst (complete list)” bit is “1”, it indicates that the previously existing G List is replaced with the defect list (D List) transferred from the INIT when this command is executed. When this bit is “0,” the contents of the D List are added to those of the previously existing G List.

The “Defect List Format” field specifies the format of the defect list (D List) transferred from the INIT when the “FmtData (format data)” bit is “1.” Any one of the following formats can be specified for the defect list.

Defect List Format			D List Format
0	0	0	Block Address Format
1	0	0	Byte Distance from the Index Format
1	0	1	Physical Sector Address Format

If (0,0,0) is specified in the Defect List Format field and a value other than 0 is specified in “Defect List Length” in the Format parameters, this command is terminated with a CHECK CONDITION status (ILLEGAL REQUEST / Invalid field in parameter list).

The “Interleave factor” field in the CDB specifies the method of positioning logical data blocks in physical sectors on the disk media. Whichever value is specified in this field, the IDD does not apply sector interleave, but physically positions logical data blocks continuously in continuous sectors.

(3) Format parameters

Figure 3.23 shows the data format of the Format parameter transferred from the INIT when “1” is specified in the “FmtData (format data)” bit of the CDB.

Header

Bit Byte	7	6	5	4	3	2	1	0
0	X'00'							
1	FOV	DPRY	DCRT	STPF	0	0	Immed	0
	0	0	0	0				
	1	0/1	0/1	×				
2	Defect List Length (MSB)							
3	Defect List Length (LSB)							

Defect List (D List)

Bit Byte	7	6	5	4	3	2	1	0
0	Defect Descriptor 0							
1								
~	~							
~	~							
x	~							
~	~							
~	~							
xx	Defect Descriptor n							
xx+1								
~	~							
~	~							
xx+x	~							

Figure 3.23 FORMAT UNIT command parameter list configuration

a. Header

The top of the format parameter transferred from the INIT is a 4-byte header. The INIT can specify the method used for defect processing that is executed by this command by control flags within the header.

- **FOV (format option valid)**

- 0: Indicates that the INIT does not specially specify concerning the functions specified by the control flags in bits 6 to 4 of byte 1 (see following “DPRY” to “STPF”). The IDD executes format processing in accordance with the default values of the various control flags. If the INIT specifies “0” in this bit, “0” must be specified in all the control flags in bits 6 to 4 of byte 1.
- 1: Indicates that the INIT is clearly specifying the functions specified by the control flags in bits 6 to 4 of byte 1 (see following “DPRY” to “STPF”). The IDD executes format processing according to the values specified in the various control flags.

- **DPRY (disable primary): Default value: “0”**

- 0: Specifies execution of format processing using the P List. Alternate blocks are allocated as substitutes for sectors in which defects registered in the P List exist, and logical data blocks are not positioned there.
- 1: Specifies use of the P List in defect processing. Even if this value is specified, the P List itself is saved without being erased.

Note:

When the disk media is being initialized for normal operation, the P List must by all means be used. Therefore, “0” should be specified in this bit.

- **DCRT (disable certification): Default value: “0”**

- 0: Specifies that data block verification be performed after initialization of the disk media. The IDD confirms that all logical data blocks can be read from normally after initialization is completed. Any defective data blocks detected in this verify operation are registered as a C List and alternate blocks are allocated for those data blocks.
- 1: Indicates that data block verify operations are prohibited after initialization of the disk media.

- **STPF (stop format): Default value: “1”**

When the defect list (P List or G List) necessary for executing the defect processing specified in this command, cannot be read from the disk media, this bit indicates whether to continue (“0” is specified) or terminate (“1” is specified) command processing, but in the IDD, this bit’s specification is disabled, and the specified value is disregarded. When the necessary defect list cannot be read, this command is terminated with a CHECK CONDITION status. The sense data at this time indicate “MEDIUM ERROR [=3] / Primary defect list not found [=1C-01]” or “MEDIUM ERROR [=3] / Defect list error in primary list [=19-02],” if the P List cannot be read and “MEDIUM ERROR [=3] / Grown defect list not found [=1C-02]” or “MEDIUM ERROR [=3] / Defect list error in grown list [=19-03],” if the G List cannot be read.

- **Immed (Immediate)**

“1” : If “1” is specified in the Immed (immediate) bit, at the point when the CDB’s legality is confirmed, or at the point when transfer of the defect list is completed, a “GOOD” status is reported.

“0” : If “0” is specified in the Immed (immediate) bit, the specified operation is executed and the status is reported at the point when that operation is completed, then the command is terminated.

- **Defect list length**

This field specifies the total number of bytes in the “Defect list” transferred from the INIT following the header. The byte length of the “Defect descriptor” which configures the defect list differs depending on its format and the value specified by this field must be a multiple of 4 when the defect descriptor is in the block address format, and must be a multiple of 8 when the defect descriptor is in the byte distance from the index format or the physical sector address format. When zero is specified in this field, it indicates that the defect list is not transferred.

Note:

The disk media defect processing method implemented during FORMAT UNIT command execution is specified by the CDB and by header of the format parameters transferred from the INIT. By specifying zero in the “Defect list length” field in the Format parameter header, the INIT can specify the control flags related to formatting processing without transferring the defect list (D List).

b. Defect list (D List)

The defect list (D List) contains defect position information about the disk media specified by the INIT and is configured from one or more “Defect descriptors.” “Defect descriptors must be described in the format specified in the “Defect List Format” field of the CDB.

The configurations which it is possible to specify for the “Defect descriptors” in the defect list (D List), and their description formats, are shown below. Furthermore, it is possible only to specify User Space address information on the disk media in the Defect list (D List).

- **Byte distance from the index format defect descriptor**

Figure 3.24 shows this description format of the defect descriptor. Defect descriptor in this format specifies the cylinder number, head (track) number and byte distance to the top byte of those data (8 bytes), of the data which includes defective bits, on the disk media. One defect is treated as a defect with a length of 8 bytes (64 bits length). Therefore, for defects with a length which exceeds 8 bytes, 2 or more defect descriptors must be specified. When multiple defect descriptors are specified, the cylinder number must be specified in the top position, the byte distance from the index in the bottom position, and the defect positions listed in ascending order.

Note:

Even if X'FFFFFFFF' is specified as the byte distance from the index to the defect position, a whole track cannot be considered defective.

Byte \ Bit	7	6	5	4	3	2	1	0
0	Cylinder No. (MSB)							
1	Cylinder No.							
2	Cylinder No. (LSB)							
3	Head No.							
4	Byte distance from index to defect position (MSB)							
5	Byte distance from index to defect position							
6	Byte distance from index to defect position							
7	Byte distance from index to defect position (LSB)							

Figure 3.24 Defect descriptor: Byte distance from index format

- **Physical sector address format defect descriptor**

Figure 3.25 shows this description format of the defect descriptor. A defect descriptor with this format specifies the physical sector number of the data block which includes the defect on the disk media together with the cylinder No. and the head (track) No. When specifying multiple defect descriptors, the cylinder No. must be specified in the top position and the physical sector No. in the bottom position, with the defect positions listed in ascending order.

Note:

Sector numbers described in this format are physical sector numbers which do not apply the "Track skew factor" and the "Cylinder skew factor."

Also, even if X'FFFFFFFF' is specified as the byte distance from the index to the defect position, a whole track cannot be considered defective.

Byte \ Bit	7	6	5	4	3	2	1	0
0	Cylinder No. (MSB)							
1	Cylinder No.							
2	Cylinder No. (LSB)							
3	Head No.							
4	Physical sector No. of defective block (MSB)							
5	Physical sector No. of defective block							
6	Physical sector No. of defective block							
7	Physical sector No. of defective block (LSB)							

Figure 3.25 Defect descriptor: physical sector address format

- **Cautions in specifying the D list**

The P List, containing defect position information, is always recorded on the IDD when it is shipped from the factory. Also, information on defect positions for which alternate block processing has been implemented during operation are recorded as the G List. The function which specifies defect position information as the D List when the FORMAT UNIT command is executed, is prepared mainly to specify initial defect position information of the disk media which does not have the P List recorded on it. In the IDD, by specifying use of the P List and G List, advance notice of the defect positions can be specified during initialization, so ordinarily, it is not necessary to use the D List. When the D List is used for the IDD, caution should be exercised in the follow points.

1. The maximum number of defective sectors (total amount of 'sector slip' and 'alternate sectors') are calculated per :
 - a) Current condition of reallocated sectors:
(how many Slip Sectors have been allocated? and so Alternate Sectors? Since Defect table entry for Slip and Alternate are different size.)
 - b) The maximum size of Defect Management Table (Fixed value)
 - c) Current allocation condition of 'sector slip'
(i.e. Up to 16 consecutive Slip Sector can be controlled by 1 Slip Defect entry. So the necessary table size are varied not only the number of Defects but also the number of consecutive Slips.)

Consequently, the concrete Defect numbers cannot be described though the IDD guarantees 12,000 Slip Sectors and 3,000 Alternate Sectors at minimum. If defect processing which exceeds this limit is specified in the FORMAT UNIT command, that command is terminated with a CHECK CONDITION status (HARDWARE ERROR [=4] / No defect spare location available [=32-00]).

2. A defect descriptor specified as the D List are received normally if the specified defect position information is within a range which does not exceed the disk drive's physical boundaries (User Space), and is recorded as the G List, but formatting processing is executed only for the User

Space in the range specified in the “Block descriptor” and “Format parameters” (Page 3), and the “Drive parameters” (Page 4) of the MODE SELECT parameter.

3. If a defect descriptor in the “Byte distance from the Index format” is specified in the D List, depending on the byte position of the specified defective byte, 1 sector may be processed as a defective sector with 2 or more defect descriptors. Also, if the specified defective byte position has no influence on data block read/write operations, that defect position information is disregarded and is not the object of defective sector processing, and thus is not recorded in the G List. Therefore, the defect position information specified in this command may not necessarily coincide with the defect position information read with the READ DEFECT DATA command after this command is terminated.

(4) Defect processing during initialization

Table 3.5 shows each combination of control flag specification values and the contents of processing executed by the IDD. Furthermore, see Chapter 3 “Data Format” of the “Product Manual” concerning alternate block allocation processing methods.

Table 3.5 FORMAT UNIT command defect processing (1 of 3)

CDB Byte 1			Header			Defect Processing Method
FmtData	CmpLst	Defect List Format	FOV	DPRY	Defect List Length	
0	–	– – –	(Format parameters not transferred)			① Alternate block allocation is performed for defects registered in the P List. ② The previously existing G List is erased.
1	0	d d d	0 1	0 0	Zero	① Alternate block allocation is performed for defects registered in the P List and the previously existing G List. ② The previously existing G List is saved.
1	0	d d d	1	1	Zero	① Alternate block allocation is performed for defects registered in the previously existing G List. ② The P List is saved, but it is not used in defect processing. ③ The previously existing G List is saved.
1	1	d d d	0 1	0 0	Zero	① Alternate block allocation is performed for defects registered in the P List. ② The previously existing G List is erased and it is not used in defect processing.

Table 3.5 FORMAT UNIT command defect processing (2 of 3)

CDB Byte 1			Header			Defect Processing Method
FmtData	CmpLst	Defect list format	FOV	DPRY	Defect List Length	
1	1	d d d (Note 1, Note 2)	1	1	Zero	① Neither the P List or the G List is used in defect processing (alternate block allocation processing is not performed.) ② The P List is saved, but the previously existing G List is erased.
1	0	1 0 0 1 0 1 (Note 3)	0 1	0 0	>0	① Alternate block allocation is performed for defects registered in the P List, in the previously existing G List and the defects described in the D List transferred from the INIT. ② The D List is added to the previously existing G List.
1	0	1 0 0 1 0 1 (Note 1, Note 3)	1	1	>0	① Alternate block allocation is performed for defects registered in the previously existing G List and the defects described in the D List transferred from the INIT. ② The P List is saved, but it is not used in defect processing. ③ The D List is added to the previously existing G List
1	1	1 0 0 1 0 1	0 1	0 0	>0	① Alternate block allocation is performed for defects described in the D List transferred from the INIT. ② The previously existing G List is erased and it is not used in defect processing. ③ The D List is registered as the new G list.
1	1	1 0 0 1 0 1	1	1	>0	① Alternate block allocation is performed for defects registered in the P List and the defects described in the D List transferred from the INIT. ② The P List is saved, but it is not used in defect processing. ③ The previously existing G List is erased and it is not used in defect processing. ④ The D List is added to the previously existing G List.

Table 3.5 **FORMAT UNIT command defect processing (3 of 3)**

- Note 1)** ddd: 0,0,0= D List in the block address format.
 1,0,0= D List in the byte distance from the index format.
 1,0,1= D List in the physical sector address format.
- Note 2)** The D List is not transferred from the INIT.
- Note 3)** If the data block length is changed and the disk media is initialized, the INIT cannot specify a combination defect processing method.
- Note 4)** When this combination of defect processing methods is specified, the IDD performs verification of the data blocks after initialization and creates the C List. In other combination defect processing methods, the INIT can clearly specify whether the verification operation is prohibited or permitted by the DCRT flag of the Format parameter.

3.3.2 REASSIGN BLOCKS (07)

Bit Byte	7	6	5	4	3	2	1	0
0	X'07'							
1	LUN			0	0	0	0	0
2	0	0	0	0	0	0	0	0
3	0	0	0	0	0	0	0	0
4	0	0	0	0	0	0	0	0
5	0	0	0	0	0	0	0	Link

This command allocates alternate data blocks for defective data blocks specified in the “Defect Data” list transferred from the INIT. See Chapter 3, “Product Specifications/Installation Procedures” in the Product Manual concerning alternate block processing methods implemented by this command.

The INIT specifies the logical block address of one or more defective data blocks in the “Defect Data” list which it transfers to the IDD. The IDD searches for unused spare sectors for use as alternate blocks and allocates these alternate blocks for the specified logical data blocks. Also, in the case of data blocks for which alternate data blocks have already been specified, the IDD allocates other usable spare sectors as alternate blocks for those data blocks.

Using this command, copying of the contents of the data in the logical data blocks specified in the “Defect data” list to the allocated alternate data blocks is attempted. If the data in logical data blocks which are specified in the “Defect data” list are correctable by ECC correction, the corrected data are copied and those data which are not correctable by ECC are copied as is in the uncorrected state (including the errors) and in the case of other media errors, X '00' is copied in all bytes. Furthermore, the contents of data in data blocks other than the logical data blocks specified in the “Defect Data” list are not influenced by the alternate allocation processing through this command.

Note:

Copying of the contents of data in the logical data blocks specified in the “Defect data” list to alternate blocks allocated by this command is attempted, but in some cases, copying cannot be done. Confirmation of the contents of the data in allocated alternate blocks, saving of data before issuing this command and restoring of data after this command is executed are the responsibility of the INIT.

The format of the “Defect Data” list transferred from the INIT by this command is shown in Figure 3.26.

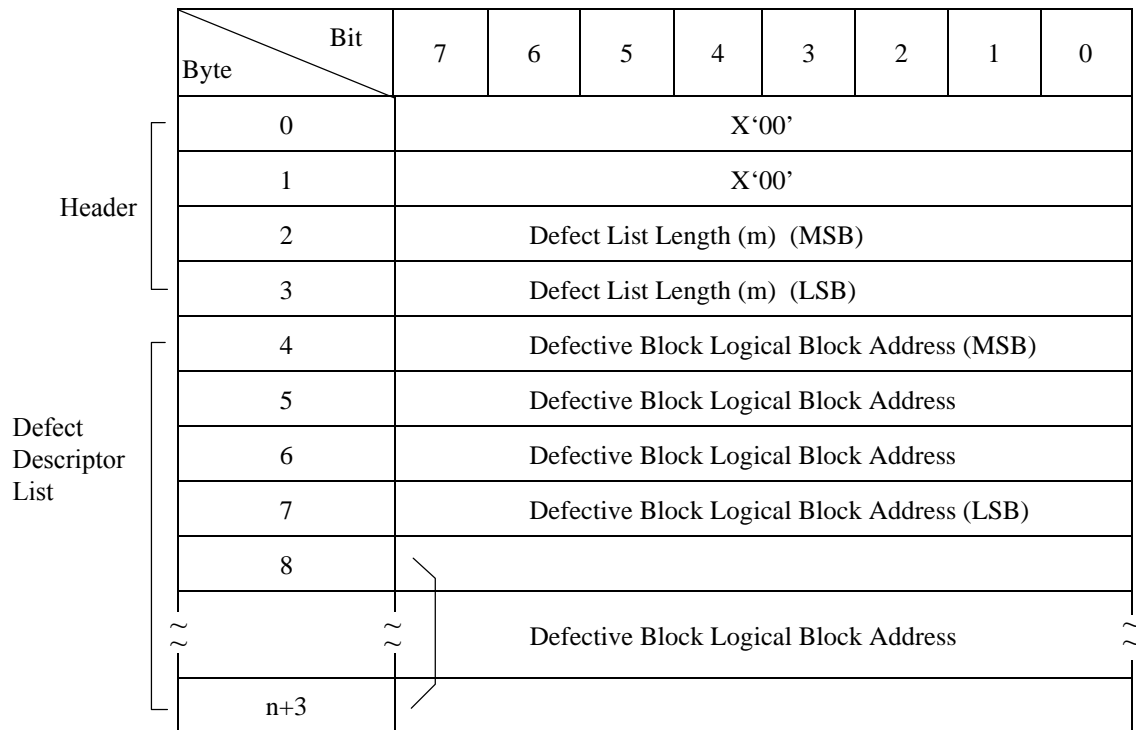

Figure 3.26 REASSIGN BLOCK command: defect data list configuration

The “Defect data” list is configured from a 4-byte header and one or more defect descriptors which follow it. One defect descriptor has a length of 4 bytes.

The “Defect list length” field in the header indicates the total number of bytes (m) of the defect descriptor list transferred after the header, and must be a multiple of 4. Also, when zero is specified in this field, this command is terminated without transfer of the defect descriptor list and allocation processing of alternate blocks.

Note:

The Defect list length that can be specified for the IDD is 2,044 (X '7FC') bytes or less. Therefore, a maximum of 511 defective blocks can be specified in the REASSIGN BLOCKS command.

The logical block address of defective data blocks is described in 4-byte format in the defect descriptor. When multiple defect descriptors are specified, it is best for the INIT to describe defect descriptors in the ascending order of the logical data block addresses.

Furthermore, if the addresses of logical data blocks specified in the defect descriptor list overlap each other, This command is terminated with a CHECK CONDITION status (ILLEGAL REQUEST [=5] / Invalid field in parameter list [=26-00] and none of the alternate block allocation processing in that command is executed.

The IDD allocates alternate blocks to the specified data blocks in order from the top of the defect descriptor list. When all the usable spare sectors have been used up, and it is impossible to allocate alternate blocks, execution of this command is terminated at that point and a CHECK CONDITION status is reported. The sense data at this time indicate the following contents.

- Sense key: 4 = HARDWARE ERROR
- Additional sense code/
Additional sense code qualifier: 32-00 = No defect spare location available
- “VALID” bit: “1”
- Information field ————— Logical block address specified in the defect descriptor at the point when alternate block allocation becomes impossible.
- Command inherent information field ————

Also, when this command is terminated abnormally with a CHECK CONDITION status due to any one of several other types of error besides the above error, the logical block address specified in the first defect descriptor which did not undergo alternate block allocation is reported in the “Command inherent information” field in the sense data. However, if alternate block allocation processing of the defect descriptors for which alternate block allocation has not been implemented cannot be specified, or if alternate block allocation of all the specified defect descriptors has been completed, the “Command inherent information” field indicates X ‘FFFFFFF.’

When alternate block allocation processing is successful, the defect position information on the disk media related to the data blocks specified in the defect descriptor list is recorded on the disk media as the defect list (G List). The INIT can read the contents of the G List using the READ DEFECT DATA command. Also, this command has no influence on the contents of the primary defect list (P List).

Note:

The defect position information in the G List is physical block addresses (logical data block addresses are allocated when no defect exists on the disk media). Therefore, the values specified in this command’s defect descriptor list (logical block addresses) may not necessarily be the same as the contents of the G List read by the READ DEFECT DATA command after this command is terminated. For details, see the description of the READ DEFECT DATA command (Section 3.3.3).

Note: Precautions for use of command

If this command is terminated with a CHECK CONDITION status, the additional sense code/additional sense code qualifier in the sense data is other than “No defect spare location available [=32-00], and a valid logical block address (other than X ‘FFFFFFF’) is displayed in the “Command inherent information” field, it is necessary for the INIT to reissue this command by the following procedure after executing recovery processing (shown in Section 5.2) in accordance with the contents of the sense data.

1. Delete the defect descriptors which precede the defect descriptor that specifies the logical block address displayed in the “Command inherent information” field of the sense data from the defect descriptor list specified in this command, and leave that defect descriptor in the list.

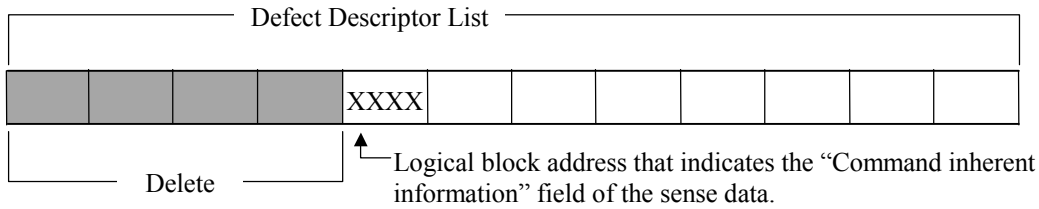

2. Change the “Defect List Length” in the header and add the new ”Defect descriptor list” corrected in 1), then reissue the REASSIGN BLOCKS command.

3.3.3 READ DEFECT DATA (37)

Bit Byte	7	6	5	4	3	2	1	0
0	X'37'							
1	LUN			0	0	0	0	0
2	0	0	0	PList	GList	Defect List Format		
3	0	0	0	0	0	0	0	0
4	0	0	0	0	0	0	0	0
5	0	0	0	0	0	0	0	0
6	0	0	0	0	0	0	0	0
7	Transfer Byte Length (MSB)							
8	Transfer Byte Length (LSB)							
9	0	0	0	0	0	0	0	Link

This command transfers the list described in the defect position information of the disk media (defect data) to the INIT.

There are two types of defect data, the P List (primary defect list) and the G list (grown defect list). The P List indicates the defect position information at the time the disk drive was shipped from the factory. On the other hand, the G List shows the defect position information specified from the INIT by the REASSIGN BLOCKS command or automatic alternate block allocation processing, or when executing the FORMAT UNIT command, or defective data block positional information from alternate block allocation from Verify operation after initialization.

The INIT can specify the defect data type transferred to the INIT by the “P List (primary list)” bit and “G List (grown list)” bit in the CDB and can specify the defect data format by the “Defect List Format” field.

PList	GList	Defect Data Type
1	1	P List and G List
1	0	P List only
0	1	G List only
0	0	4-byte header information only (described in this section)

Defect List Format	Defect Data Format		
0 0 0	Block Address Format		
1 0 0	Byte Distance from the Index Format		
1 0 1	Physical Sector Address Format		

The “Transfer byte length” field in the CDB specifies the defect data length (number of bytes) that can be received by the INIT. The IDD terminates data transfer when transfer of the length of defect data specified in the “Transfer byte length” field is completed or when transfer of all the defect data of the specified type is completed. Also, when zero is specified in the “Transfer byte length” field, this command is terminated without execution of data transfer.

Figure 3.27 shows the format of defect data transferred to the INIT by this command.

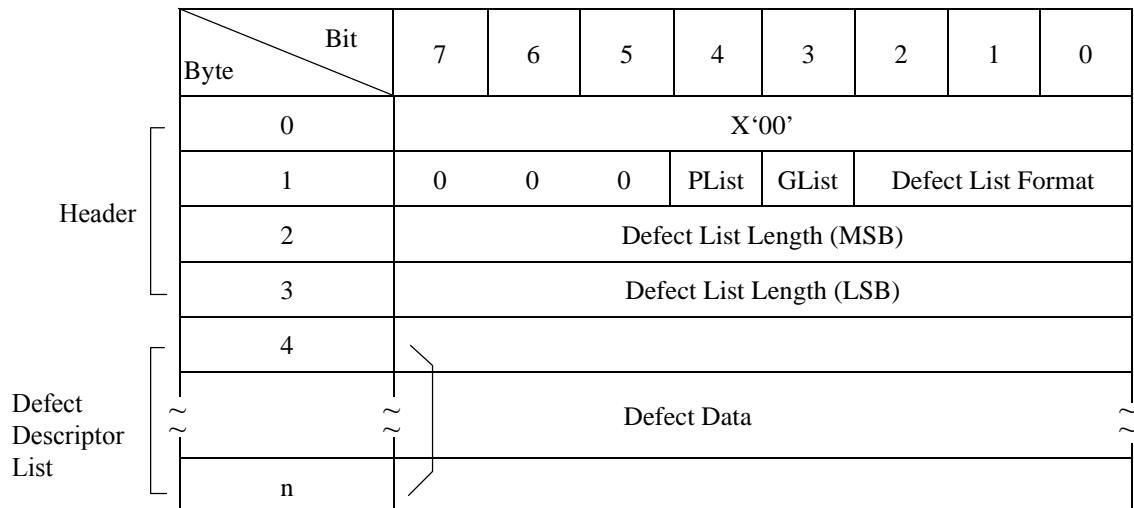

Figure 3.27 READ DEFECT DATA command (37): Defect data configuration

(1) Header

a. P List (primary list) bit

When this bit is “1,” it indicates that P List defect data are included in the defect descriptor list that is actually transferred to the INIT. When it is “0,” it indicates that the P List defect data are not included. See 3) of item (2).)

b. G List (grown list) bit

When this bit is “1,” it indicates that G List defect data are included in the defect descriptor list that is actually transferred to the INIT. When it is “0,” it indicates that the G List defect data are not included. See 3) of item (2).)

c. Defect list format

This field indicates the description format of the defect descriptor list that is actually transferred to the INIT. It is possible for the IDD to transfer defect data in 3 different formats which it can specify in the CDB, and the values in this field are the same as the values specified in the “Defect List Format” field in the CDB.

d. Defect list length

This field follows the 4-byte header and indicates the total number of bytes of defect descriptor list that can be transferred. It has either 4 or 8 bytes, depending on the format of the defect descriptor. Also, the values shown in this field are the total number of bytes described in the “Defect List Format” which specifies the specified type (P List or G List) of defect data, regardless of the value specified in the “Transfer byte length” field in the CDB. The INIT should check whether the value shown in this field plus 4 is a smaller value than that specified in the “Transfer byte count” field in the CDB in order to confirm that all the defect data requested in this command have been transferred. Also, since the value shown in this field is divided by the number of bytes (4 or 8) per defect descriptor (quotient), the INIT can know the number of defects on the disk media.

(2) Defect descriptor list

The data transferred after the 4-byte header is the “Defect descriptor” list (Defect data) in which the defect position information are described with the type and format specified in the CDB. One “Defect descriptor” has a length of 4 bytes when in the “Block address format,” and a length of 8 bytes when in the “Byte distance from the index format” and “Physical sector address format.” The “Defect descriptors” do not necessarily transfer defect position information in ascending order.

See the description of the FORMAT UNIT command (Section 3.3.1) concerning the configuration and contents of the “Defect descriptor” in each format.

Notes: Precautions for use of command

1. When “1” is specified in both the “P List” bit and the “G List” bit in the CDB, and transfer of both the P List and G List is requested, the IDD first of all transfers the P List, then transfers the G List afterward (merging of the defect information in the two lists is not performed).
2. When “0” is specified in both the “PList” bit and the “GList” bit in the CDB, only the header is transferred by that command, but the following information is shown in the header at this time.
 - PList bit: “0”
 - GList bit: “0”
 - Defect List Length field: The total number of bytes described in the “Defect List Format” specifying defect data included in the P List and G List.

3. Even if defect data of the type specified in the CDB do not exist in the defect list (P List or G List) (if the defect list is empty), “1” is displayed in the “PList” bit and the “GList” bit in the header transferred to the INIT corresponding to the specification in the CDB.
4. By the INIT issuing this command specifying “4” in the “Transfer Byte Length” field in the CDB, and by investigating the information in the header transferred by the IDD, it can know the length (number) of data included in the P List and G List.
5. Depending on the combination of defect data type specifications and format specifications, the following conditions exist concerning the transferred defect data, so caution is necessary.

Defect List Format	PList	GList
Block Address Format	2)	2)
Byte Distance from the Index Format	1)	1), 3)
Physical Sector Address Format	1)	1)

- 1) Regardless of the size of the User Space, all the defect position information for the disk media other than the system space is reported. Defect position information is also reported for areas which cannot be clearly accessed from the INIT, such as the spare sectors for alternate blocks.
 - 2) Logical data blocks which have undergone slip processing due to defective sectors, and logical data blocks which have undergone alternate processing, are reported. Defect position information is not reported for areas which cannot be clearly accessed from the INIT (areas which do not have logical block addresses) such as cylinders and sectors, etc. which are not used as User Space or CE Space.
 - 3) The byte position which indicates the first byte in defective sector data is reported.
6. The number of defects reported by this command differs depending on the defect data format.
 - When data are in the “Block Address Format,” defect position information is not reported for portions which cannot be clearly accessed from the INIT.
 - When data are in the “Block Address Format” or the “Physical Sector Address Format,” even if defects exist in multiple locations within that sector, that defect information is reported by one defect descriptor.
 - When data are in the “Byte Distance from the Index Format,” all the registered defect positions are reported when the P List is reported, but in the case of the “Block Address Format” and the “Physical Sector Address Format,” the defect position information is not reported for defects which do not have an influence on data block read/write operations.
 - When data are in the “Byte Distance from the Index Format,” when the P List is reported, multiple defect position information may be reported for a single sector, or 2 defective sectors may be reported as a single item of defect position information due to defects which extend across sector boundaries.

7. In defect data in the block address format, all the physical defect position information on the disk media cannot be described universally. For example, defect position information in areas without block addresses (spare sectors, or cylinders which are not being used as User Space or CE Space) cannot be described. The defect data in this format are provided in order to preserve continuity with previous specifications, but it is recommended that as much as possible, the INIT not use the “Block Address Format.”

3.3.4 READ DEFECT DATA (B7)

		Bit								Remark
		7	6	5	4	3	2	1	0	
Byte	00	1	0	1	1	0	1	1	1	X'B7'
	01	LUN			PList	GList	Defect List Format			
	02	0	0	0	0	0	0	0	0	X'00'
	03	0	0	0	0	0	0	0	0	X'00'
	04	0	0	0	0	0	0	0	0	X'00'
	05	0	0	0	0	0	0	0	0	X'00'
	06	Transfer Byte Length (MSB)								
	07	Transfer Byte Length								
	08	Transfer Byte Length								
	09	Transfer Byte Length (LSB)								
	10	0	0	0	0	0	0	0	0	X'00'
	11	0	0	0	0	0	0	0	Link	Control

This command transfers the list containing the defect position information of disk media (defect data) to the INIT.

The command is the same as the READ DEFECT DATA command (37) described in Section 3.3.3 except for the following: the transfer byte length can be specified in four bytes and the defect list length can be specified in four bytes in this command.

Figure 3.28 shows the format of defect data that is transferred to the INIT by this command.

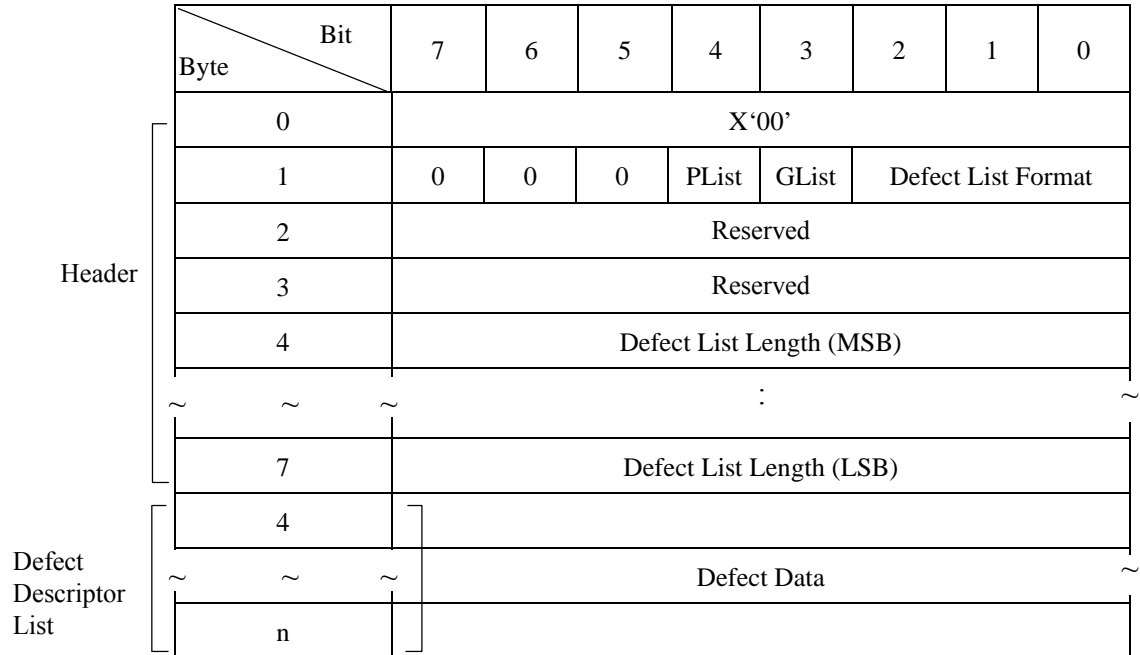

Figure 3.28 READ DEFECT DATA command (B7): Defect data configuration

3.4 Maintenance, Diagnostic Commands

3.4.1 SEND DIAGNOSTIC (1D)

Byte \ Bit	7	6	5	4	3	2	1	0
0	X'1D'							
1	SELF-TEST CODE			PF	0	SelfTest	DevOfI	UnitOfI
2	0	0	0	0	0	0	0	0
3	Parameter List Length (MSB)							
4	Parameter List Length (LSB)							
5	0	0	0	0	0	0	0	Link

This command executes self-diagnosis tests which the IDD is equipped to perform and operation specified in the parameter list transferred from the INIT.

(1) Self-diagnosis test

When the “SelfTest (self test)” bit is “1,” and “Self-Test Code” field is “000” in the CDB, this command specifies execution of the self-diagnosis test which the IDD is equipped to perform. At this time, the “PF (page format)” bit and the “Parameter list length” field in the CDB have no meaning and the values specified there are disregarded. Also, the “DevOfI (device off-line)” bit specifies whether or not operations which have an influence on the status of logical units other than the logical unit specified in this command during the self-diagnosis test, but in the IDD, there is only 1 logical unit that exists. Therefore, the specification in this bit has no meaning and the specified value is disregarded.

The INIT can specify the type of self-diagnosis test to be executed through the “UnitOfI (unit off-line)” bit. When “1” is specified in the “SelfTest (self test)” bit, the IDD executes a series of self-diagnosis tests in accordance with the combination with the “UnitOfI (unit off-line)” bit, as shown below.

Type of Self-diagnosis Test	UnotOfI = “0”	UnitOfI = “1”
1) Controller Function Test	×	×
2) Disk Drive Seek Test		×
3) Disk Media (CE Space) Write/Read/Data Comparison Test		×

×: Execution Object

When the IDD completes all the specified self-diagnosis tests normally, it reports a GOOD status. On the other hand, when an error is detected in any of the specified self-diagnosis tests, a CHECK CONDITION status is reported and information related to the detected error is shown in the sense data. For example, when an error is detected in the controller function test, the type of error is shown by HARDWARE ERROR [=4] in the sense key, and the additional sense code/additional sense code qualifier show “Diagnostic failure on component ‘nn’ [=40-nn].” (nn is the code in the range X ‘80’ to X ‘FF,’ which shows the type of error. This code is a Fujitsu unique definition for the purpose of analysis when there is a failure, and its meaning is not released to the public. The user should present the value displayed in this sense data as repair information to the Fujitsu representative.)

Furthermore, error recovery processing when diagnostic tests (seek tests and write/read/data comparison tests) related to the disk drive are executed are in accordance with the mode set in the MODE SELECT command’s parameters (Page code 1: Read/Write Error Recovery parameter, Page code 21: Additional Error Recovery parameter), except in the following special cases.

Special cases of MODE SELECT parameters during a self-diagnosis test are as shown below

- The AWRE, ARRE and TB flags are not applied.
- The PER and DTE flags are as shown in Table 3.6.

Table 3.6 Error recovery control flags during the self-diagnosis test

PER	DTE	Diagnostic test operation
0	0	The diagnostic test continues when error recovery is successful. The contents of recovered errors are not reported. When an error which cannot be recovered from is detected, the diagnostic test terminates at that point with an error.
0	1	----- (Setting prohibited) -----
1	0	The diagnostic test continues when error recovery is successful. When an error which cannot be recovered from is detected, the diagnostic test terminates at that point with an error. Even when all the detected errors have been recovered, a CHECK CONDITION status (RECOVERED ERROR [=1]) is reported after the series of diagnostic tests is completed and the sense data show the contents of the last error to be successfully recovered from.
1	1	When error recovery is successful, or even when error recovery is impossible, the diagnostic test is terminated with an error at the point when the permitted error recovery processing is completed and a CHECK CONDITION status is reported. The sense data show the contents of the detected error.

Note:

When “1” is specified in the “SelfTest (self test)” bit in this command, the command execution results are reported by the status and the sense data. Therefore, even if the RECEIVE DIAGNOSTIC RESULTS command is executed after this command, the self-diagnosis test execution results are not reported as response data.

Remark:

The error recovery control flag is valid only for PER. Therefore, the only error recovery flag combination that is actually executed in the above self-diagnosis tests is the (PER, DTE) = (1, 0) combination.

(2) Parameter specification

When “0” is specified in the “SelfTest (self test)” bit in the CDB, the IDD executes the operations specified in the parameter list transferred from the INIT by this command. In this case, the IDD reports a GOOD status and terminates this command at the point when preparation of the “response data” is completed after completing the specified operations. The INIT can read the execution results (response data) by the RECEIVE DIAGNOSTIC RESULTS command.

When the “PF (page format)” bit in the CDB is “1,” the parameter list transferred from the INIT by this command shows the page format, explained later, but the IDD disregards the value specified in this bit and always handles the page format according to the specifications in the parameter list when the parameter list is transferred by this command. Also, when the “SelfTest (self test)” bit is “0,” the specifications in the “DefOfl (device off-line)” bit and the “UnitOfl (unit off-line)” bit have no meaning and their specified values are disregarded.

The “Parameter list length” field in the CDB shows the length (number of bytes) of the parameter list that is transferred from the INIT when the “SelfTest (self test)” bit’s specification is “0.” When zero is specified in the “Parameter list length” field, this command is terminated without anything being executed. Also, when the value specified in the “Parameter list length” field does not reach the specified length for the parameter list, explained later, and as a result, not all the bytes in the parameter list can be

received, that command is terminated with a CHECK CONDITION status (ILLEGAL REQUEST) [=5] / Invalid field in CDB [=24-00]).

Figure 3.29 shows the format of the parameter list (called the parameter page) transferred from the INIT to the IDD by this command. The parameter page is configured from the 4-byte “Page Header” and the “Page Parameters” which follow it. Furthermore, the INIT can specify only a single parameter page by this command. Even when multiple parameter pages have been specified by the INIT, the IDD executes only the operation specified by the top parameter page.

Notes

1. When “0” is specified in the “SelfTest (self test)” bit in this command, the INIT can specify only a single parameter page.
2. In order to avoid loss of security to the execution results (response data) of this command due to another command issued by another INIT, when “0” is specified in the “SelfTest (self test)” bit, the INIT should issue this command linked to the RECEIVE DIAGNOSTIC RESULTS command or reserve the IDD before issuing this command, and should release the reserve status after executing the RECEIVE DIAGNOSTIC RESULTS command.
3. When a command other than the RECEIVE DIAGNOSTIC RESULTS command is linked to this command, the execution results (response data) may no longer be secure.

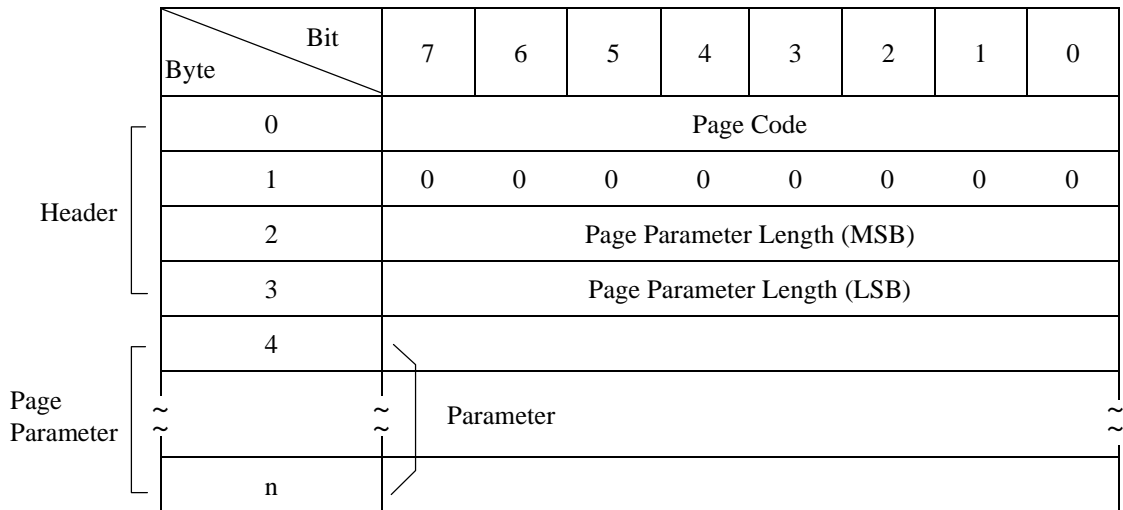

Figure 3.29 SEND DIAGNOSTIC command: parameter list configuration

- **Page code**

This field specifies the code which identifies the type of parameter page being transferred from the INIT and the operation that should be executed. The parameter pages which can be specified by the INIT and their functions are as shown below.

Page Code (Hex)	Function
00	Reports a list of the supported page codes.
40	Logical/Physical Address Conversion

- **Page parameter length**

This field specifies the byte length of the page parameter after byte 4. The INIT must specify the same value as the length specified for each of the parameter pages, which will be explained later.

- **Page parameter**

This field specifies each of the inherent parameters in each page code. Depending on the page code, this field may not be necessary (page parameter length = 0).

- a. Page code list

This parameter page specifies transfer of the “Page code” list of the parameter page supported by the IDD in the SEND DIAGNOSTIC command and the RECEIVE DIAGNOSTIC RESULTS command to the INIT. Figure 3.30 shows the format of this parameter page. The page code list supported by the IDD is transferred to the INIT by the RECEIVE DIAGNOSTIC RESULTS command which is issued following the SEND DIAGNOSTIC command that specifies this parameter page (shown in Section 3.4.2 (1))

Byte \ Bit	7	6	5	4	3	2	1	0
0	X '00' (Page Code)							
1	0	0	0	0	0	0	0	0
2	X '00' (Page parameter length)							
3	X '00' (Page parameter length)							

Figure 3.30 SEND DIAGNOSTIC parameters: page code list

- b. Logical/physical address conversion

This parameter page specifies conversion of the address information expressed in either the “Logical Block Address,” “Physical Sector Address” or “Byte Distance from the Index” format to another expression format. Figure 3.31 shows this parameter page format. The INIT can specify the address information that should be converted in this parameter page of the SEND DIAGNOSTIC command, and can read the conversion results by the RECEIVE DIAGNOSTIC RESULTS command (see Section 3.4.2 (2)).

Bit Byte	7	6	5	4	3	2	1	0
0	X '40' (Page Code)							
1	0	0	0	0	0	0	0	0
2	X '00' (Page Parameter Length)							
3	X '0A' (Page Parameter Length)							
4	0	0	0	0	0	Address Format Before Conversion		
5	0	0	0	0	0	Address Format After Conversion		
6								
7								
13								

Figure 3.31 SEND DIAGNOSTIC parameters: logical/physical address conversion

The “Address Format Before Conversion” field shows the format of the address information specified in bytes 6 to 13. The IDD converts that address information to the expression format specified in the “Address Format After Conversion” field. the following codes can be specified as the “Address Format.”

Code	Address Format
0 0 0	Logical Block Address Format
1 0 0	Byte Distance from the Index Format
1 0 1	Physical Sector Address Format

The description format of the address information specified in bytes 6 to 13 is the same as the description specification of the D List transferred from the INIT by the FORMAT UNIT command. For details, see the description of the FORMAT UNIT command (Section 3.3.1). furthermore, when the logical block address format is specified, it must be described in bytes 6 to 9 and zero must be specified in the remaining byte positions.

When a logical data block address which does not exist (outside the range of the MODE SELECT parameter) is specified in the logical block address format, or when an area which cannot be allocated as User Space on the disk drive (cylinders which physically do not exist) is specified in the “Byte Distance from the Index” format or the “Physical Sector Address” format, that command is terminated with a CHECK CONDITION status (ILLEGAL REQUEST [=5] / Invalid field in parameter list [=26-00]) and address conversion is not executed.

Details of the address conversion algorithm executed when this parameter page is specified and the data format, etc. of the conversion results reported to the INIT are explained in RECEIVE DIAGNOSTIC RESULTS command (Section 3.4.2).

(3) Logical unit Self-Test

When "0" is specified in the "SelfTest" bit and the values other than zero is specified in the "SELF-TEST Code" field in CDB, the IDD executes the Self-Test specified in CDB. In this case, the INIT can read the executed results (page code= x10 : Self-Test Result Log Page) by the LOG SENSE command.

The specified values in "PF" bit, "DevOffL" bit and "UnitOffL" bit in CDB are ignored.

The "Parameter List length" field shall contain zero. If the value other than zero is specified in this field, this command is terminated with a CHECK CONDITION status (ILLEGAL REQUEST [=5] / Invalid field in CDB [=24-00]).

The "SELF-TEST Code" field specifies the type of executing Self-Test by this command, as below.

SELF-TEST Code	Description
0,0,0	Refer to clause (2), Parameter Specification.
0,0,1	The IDD shall start its short self-test routine in the background mode.
0,1,0	The IDD shall start its extended self-test routine in the background mode.
0,1,1	Reserved
1,0,0	Abort the current self-test running in background mode. This value is only valid if a previous this command specified a Background self-test function and that function has not completed. If either of these conditions is not true, then the IDD shall it respond by returning a CHECK CONDITION status.
1,0,1	The IDD shall start its short self-test routine in the foreground mode.
1,1,0	The IDD shall start its extended self-test routine in the foreground mode.
1,1,1	Reserved

The Self-Test executes the following test segments in ascending order by number:

1. Buffer RAM test
2. Flash ROM test
3. Pre-SMART test
4. Low Level Format test
5. Random seek test
6. Sequential seek test
7. Data compare test
8. Random read test
9. Sequential read test
10. SMART test

3.4.2 RECEIVE DIAGNOSTIC RESULTS (1C)

Bit Byte	7	6	5	4	3	2	1	0
0	X'1C'							
1	LUN			0	0	0	0	0
2	0	0	0	0	0	0	0	0
3	Transfer Byte Length (MSB)							
4	Transfer Byte Length (LSB)							
5	0	0	0	0	0	0	0	Link

This command transfers data (response data) which show the results of executing the SEND DIAGNOSTIC command from the IDD to the INIT. The format and content of response data are determined by the parameter list (page code) specified by the INIT in the SEND DIAGNOSTIC command.

The “Transfer byte length” field in the CDB shows the maximum number of bytes of response data that can be received by the INIT by this command. The IDD transfers the number of bytes of data specified by this field or all the bytes of the effective response data, whichever is smaller in length. Also, when zero is specified in this field, this command is terminated without anything being transferred.

Notes:

Exercise caution in the following points when using this command.

1. In order to avoid damage to the results of SEND DIAGNOSTIC command execution (response data) from a command issued by another INIT during the interval until this command is issued, either this command should be linked to the SEND DIAGNOSTIC command when it is issued or the SEND DIAGNOSTIC command and this command should be executed after the IDD is reserved.
2. Response data are valid only when “0” is specified in the “SelfTest (self test)” bit and after a SEND DIAGNOSTIC command which specifies a specific operation in the parameter list is executed, with the IDD transferring response data showing the execution results of the latest SEND DIAGNOSTIC command. Also, even if this command is executed, the response data in not cleared, and remains valid until the next SEND DIAGNOSTIC command is executed.
3. If this command is issued when valid response data do not exist, the IDD transfers a maximum of 4 bytes of X ‘00’ data to the INIT.

Figure 3.32 shows the format of response data transferred to the INIT from the IDD by this command. The response data are configured from a 4-byte “Page header” and the “Page parameters” which follow it.

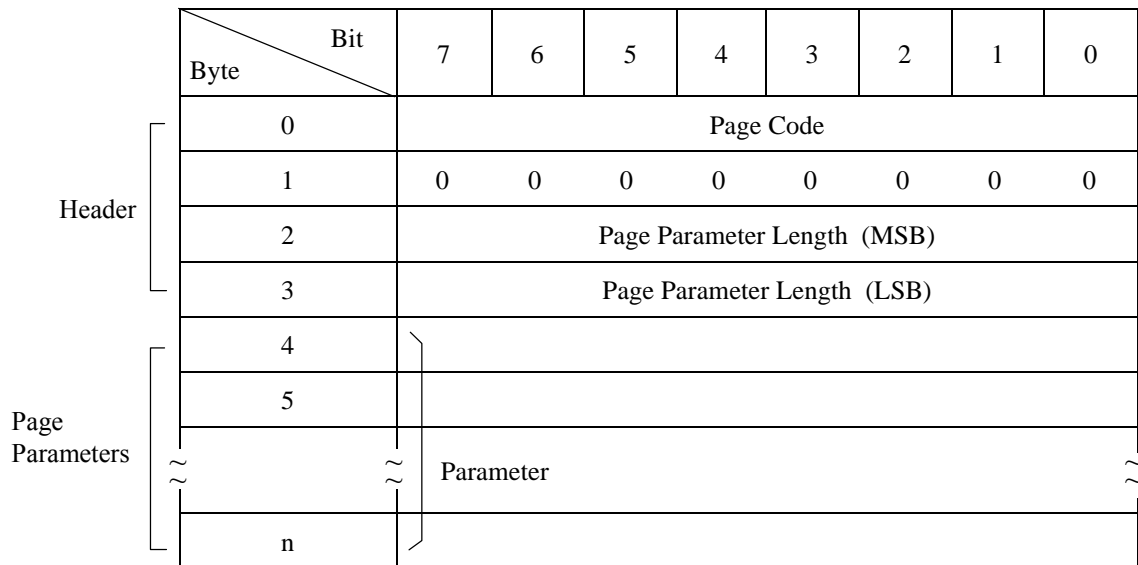

Figure 3.32 RECEIVE DIAGNOSTIC RESULTS command: Response data configuration

- **Page code**

This field is the same value as the page code specified in the parameter list transferred from the INIT by the SEND DIAGNOSTIC command executed last, and shows a code which identifies the type of response data reported in this command.

- **Page parameter length**

This field shows the byte length of the page parameter after byte 4.

- **Page parameter**

Data which show the execution results of the operation specified by the SEND DIAGNOSTIC command are reported in this field.

(1) Page code list

This response data reports the “Page code” list of the parameter page supported by the IDD in the SEND DIAGNOSTIC command and the RECEIVE DIAGNOSTIC RESULTS command after byte 4. The format and contents of this response data are shown in Figure 3.33.

Bit Byte	7	6	5	4	3	2	1	0
0	X '00' (Page Code)							
1	0	0	0	0	0	0	0	0
2	X '00' (Page Parameter Length)							
3	X '02' (Page Parameter Length)							
4	X '00' (Page Code List)							
5	X '40' (Logical/Physical Address Conversion)							

Figure 3.33 RECEIVE DIAGNOSTIC RESULTS response data: page code list

(2) Logical/physical address conversion

This response data reports the execution results of address conversion specified in the “Logical/Physical Address Conversion” parameter in the SEND DIAGNOSTIC command in bytes after byte 4. The format and contents of this response data are shown in Figure 3.34.

Bit Byte	7	6	5	4	3	2	1	0
0	X '40' (Page Code)							
1	0	0	0	0	0	0	0	0
2	X '00' (Page Parameter Length)							
3	X '0A' (Page Parameter Length)							
4	0	0	0	0	0	Address Format Before Conversion		
5	0	0	0	0	0	Address Format After Conversion		
6	Logical or Physical Address							
7								
~	~							~
13								

Figure 3.34 RECEIVE DIAGNOSTIC RESULTS response data: logical/physical address conversion

Note:

The value of the “Page Parameter Length” field in this response data is a variable length within the range of $[2 + 8n]$ in the SCSI specifications. For example, If multiple logical data blocks are located in 1 physical sector, or if 1 logical data block is located in multiple physical sectors, n address information items are reported as the address conversion results.

In the current IDD specifications, multiple address information items are not reported in this response data, but the “Page parameter length” always shows X ‘000A.’ However, considering expanded specifications in the future, the INIT should make it possible to correspond to variable lengths for the “Page parameter length.”

The “Address Format Before Conversion” field in byte 4 and the “Address Format After Conversion” field in byte 5 are the same values as the codes which show the expression format for address information specified by the SEND DIAGNOSTIC command parameters. The “Address Format After Conversion” field shows the expression format of the address information reported in bytes 6 to 13 of this response data. “Address format” codes are as shown below.

Code	Address Format
0 0 0	Logical Block Address Format
1 0 0	Byte Distance from the Index Format
1 0 1	Physical Sector Address Format

The description of address information shown in bytes 6 to 13 is the same as the description specifications in the D List transferred from the INIT by the FORMAT UNIT command. For details, see the description of the FORMAT UNIT command (Section 3.3.1). Furthermore, When the logical block format is used, the address is shown in bytes 6 to 9 and zero is reported in the remaining byte positions. However, when the address information specified in the “SEND DIAGNOSTIC command points to a position on the disk media which is not used as physical data blocks, X ‘FFFFFFFF 00000000’ is reported as the logical block address after conversion.

3.4.3 WRITE BUFFER (3B)

Byte \ Bit	7	6	5	4	3	2	1	0
0	X'3B'							
1	LUN			0	Mode			
2	Buffer ID							
3	Buffer Address (MSB)							
4	Buffer Address							
5	Buffer Address (LSB)							
6	Transfer Byte Length (MSB)							
7	Transfer Byte Length							
8	Transfer Byte Length (LSB)							
9	0	0	0	0	0	0	0	Link

This command is used in combination with the READ BUFFER command to diagnose the normality of the IDD's data buffer memory or the SCSI bus, or to download microcode to the IDD.

The IDD does not support "Buffer ID" field, and disregards any values to this field.

The functions of this command and the format of data transferred from the INIT are specified in the "Mode" field in byte 1 of the CDB and any of the transfer modes shown below can be selected.

“Mode Bit”	3	2	1	0	Transfer Mode
	0	0	0	0	Header + Data, without Address Specification
	0	0	0	1	Header + Data, with Address Specification
	0	0	1	0	Data Only, with Address Specification
	0	1	0	0	Microcode Download, without Saving
	0	1	0	1	Microcode Download, with Saving
	0	1	1	0	Microcode Download with offset, without Saving
	0	1	1	1	Microcode Download with offset, and Saving
	1	0	1	0	Echo buffer

- (1) Mode = 0, 0, 0, 0: Header + data, without address specification

In this mode, a 4-byte header (with all zero’s specified for the contents) must be added to the top of the data transferred from the INIT. Also, zero must be specified in the “Buffer address” field of the CDB.

The “Transfer byte length” field specifies the total number of bytes of data transferred from the INIT. The transfer byte count specification includes the 4 bytes of the header. The IDD stores the data transferred from the INIT with the header omitted (“Transfer byte length” – 4 bytes) in the data buffer beginning in order from the top of the data buffer (Address: X ‘000000’).

Furthermore, a value which is less than the [IDD’s buffer size + 4 bytes] must be specified in the “Transfer byte length” field in the CDB. When a value that is larger than this is specified, no data transfer with the INIT is executed. Also, when zero is specified in the “Transfer byte length” field, this command is terminated without data being transferred.

Figure 3.35 shows the format of data transferred from the INIT when this mode is specified.

		Bit	7	6	5	4	3	2	1	0
Header	Byte									
	0		0	0	0	0	0	0	0	0
	1		0	0	0	0	0	0	0	0
	2		0	0	0	0	0	0	0	0
Data	3		0	0	0	0	0	0	0	0
	4		Buffer Data (Byte 0)							
	5		Buffer Data (Byte 1)							
	~		~							
	n		Buffer Data (Byte n-4)							

Figure 3.35 WRITE BUFFER command: buffer data (Mode = 000, 001)

- (2) Mode = 0, 0, 0, 1: Header + data, with address specification

The format of data transferred from the INIT in this mode must be the same as in the case of Mode = 0, 0, 0, 0, and the 4-byte header (with zero specified in all its contents) must be added to them.

In this mode, the top address of the data buffer where the data transferred from the INIT are stored can be specified in the "Buffer address" field in the CDB.

The "Transfer byte length" field in the CDB specifies the total number of bytes of data transferred by the INIT. The transfer byte count specification includes the 4 bytes of the header. The IDD stores data transferred from the INIT, in a length in which the number of bytes in the header has been deleted from the data ("Transfer byte length" – 4 bytes) in the data buffer beginning at the byte position specified in the "Buffer address" field in the CDB.

Furthermore, a value less than the ["IDD's buffer size" – value specified in the "Buffer address" field – 4 bytes] must be specified in the "Transfer byte length" field in the CDB. When a value larger than that is specified, data transfer is not executed with the INIT. Also, when zero is specified in the "Transfer byte length" field, this command is terminated without data transfer being executed.

- (3) Mode = 0, 0, 1, 0: Data only, with address specification

In this mode, data transfer from the INIT includes buffer data only without the 4-byte header being added.

The top address of the data buffer where the data transferred from the INIT are to be stored can be specified in the "Buffer address" field.

The "Transfer byte length" field in the CDB specifies the total number of bytes of data transferred by the INIT. The IDD stores data transferred from the INIT in the data buffer beginning at the byte position specified in the "Buffer address" field in the CDB.

Furthermore, a value less than the ["IDD's buffer size" – value specified in the "Buffer address" field] must be specified in the "Transfer byte length" field in the CDB. When a value larger than that is specified, data transfer is not executed with the INIT. Also, when zero is specified in the "Transfer byte length" field, this command is terminated without data transfer being executed.

- (4) Mode = 0, 1, 0, 0: Microcode download, without saving

In this mode, the controller's microcode or control information is transferred to the IDD's control memory area. "0" must be specified in the "Buffer ID" field and the "Buffer address" field.

The "Transfer byte length" field specifies the total number of transfer bytes of data transferred from the INIT.

When downloading of microcode is completed, the IDD generates a UNIT ATTENTION condition for all the INITs. At this time, the IDD performs microprogram reboot and generates additional sense code.

The IDD operates according to this microcode until its power is switched off. If the power is switched on again, the IDD's operation returns to the existing microcode saved previously on the disk.

Note:

Depending on the setting in the IDD, if done using the START/STOP command, it is necessary to issue the START command after issuing his command. See the description of the motor starting modes in Section 5.3.2 of the "Product Manual" concerning the setting terminal.

- (5) Mode = 0, 1, 0, 1 : Microcode download, with saving

In this mode, the controller's microcode or control information is transferred to the IDD's control memory area and written to the disk. "0" must be specified in the "Buffer ID" field and the "Buffer address" field.

The "Transfer byte length" field specifies the total number of transfer bytes of data transferred from the INIT.

When all the data have been received, the IDD writes the new microcode to the non-volatile memory space the disk's system area and operates in accordance with this microcode until new microcode is downloaded.

Note:

When abnormal termination for reasons other than ILLEGAL REQUEST [=5] / Invalid field in CDB [=24-00] or ILLEGAL REQUEST [=5] / Invalid field in parameter list [=26-00] occurs, the IDD indicates that downloading of the new microcode failed, and it is therefore necessary for the INIT to quickly download the new microcode.

When downloading of microcode is completed, the IDD generates a UNIT ATTENTION condition for all the INITs except the INIT that issued the WRITE BUFFER command. At this time, the additional sense code indicates "Microcode has been changed [=3F-01]."

When the IDD is checked and downloading of the microcode is judged to be possible, the IDD may be in the Not Ready state (the state in which the spindle motor is not rotating). In this event, the IDD starts the motor, then saves the microcode to flash ROM and the system area to disk media. Then, the IDD stops the motor and returns to the Not Ready state.

- (6) Mode = 0, 1, 1, 0 : Microcode Download with offsets, without saving

In this mode the INIT may split the transfer of the controller's microcode or control information over two or more WRITE BUFFER commands.

If the last WRITE BUFFER command of a set of one or more commands completes successfully, the microcode or control information shall be transferred to the control memory space of the IDD.

Since the download microcode or control information may be sent using several commands, when the IDD detects the last download microcode with offsets, the IDD shall perform the verification of the complete set of downloaded microcode or control information prior to returning GOOD status for the last command. After the last command completes successfully the IDD generates a unit attention condition for all INITs except the one that issued the set of WRITE BUFFER commands. When reporting the unit attention condition, the IDD sets the additional sense code to MICROCODE HAS BEEN CHANGED.

"0" must be specified in the "Buffer ID" field.

The microcode or control information is written to the logical unit buffer starting at the location specified by the BUFFER Address field. If the IDD is unable to accept the specified buffer address, it shall return CHECK CONDITION status and it shall set the sense key to ILLEGAL REQUEST [=5] with an additional sense code of INVALID FIELD IN CDB [=24-00].

The "Transfer Byte Length" field specifies the maximum number of bytes that shall be present in the Data-Out Buffer to be stored in the specified buffer beginning at the buffer offset. The INIT should attempt to ensure that the parameter list length plus the buffer offset does not exceed the capacity of the specified buffer. (The capacity of the buffer may be determined by the BUFFER CAPACITY field in the READ BUFFER descriptor.) If the BUFFER Address and Transfer Byte Length fields specify a transfer in excess of the buffer capacity, the IDD shall return CHECK CONDITION status and shall set the sense key to ILLEGAL REQUEST [=5] with an additional sense code of INVALID FIELD IN CDB [=24-00].

When the IDD is checked and downloading of the microcode is judged to be possible, the IDD may be in the Not Ready state (the state in which the spindle motor is not rotating). In this event, the IDD starts the motor, then saves the microcode to flash ROM and the system area to disk media. Then, the IDD stops the motor and returns to the Not Ready state.

(7) Mode = 0, 1, 1, 1 : Microcode Download with offset, with saving

In this mode the INIT may split the transfer of the controller's microcode or control information over two or more WRITE BUFFER commands.

If the last WRITE BUFFER command of a set of one or more commands completes successfully, the microcode or control information shall be saved in the non-volatile memory space and the disk's system area.

Since the downloaded microcode or control information may be sent using several commands, when the IDD detects the last download microcode with offsets and save mode WRITE BUFFER command has been received, the IDD shall perform the verification of the complete set of downloaded microcode or control information prior to returning GOOD status for the last command. After the last command completes successfully the IDD generates a unit attention condition for all INITs except the one that issued the set of WRITE BUFFER commands. When reporting the unit attention condition, the IDD sets the additional sense code to MICROCODE HAS BEEN CHANGED.

The microcode or control information is written to the logical unit buffer starting at the location specified by the BUFFER Address field. If the IDD is unable to accept the specified buffer offset, it shall return CHECK CONDITION status and it shall set the sense key to ILLEGAL REQUEST [=5] with an additional sense code of INVALID FIELD IN CDB [=24-00].

(8) Mode = 1, 0, 1, 0 : Echo buffer

In this mode the IDD transfers data from the INIT and stores it in the echo buffer. The BUFFER ID and BUFFER OFFSET fields are ignored in this mode.

3.4.4 READ BUFFER (3C)

Byte \ Bit	7	6	5	4	3	2	1	0
0	X'3C'							
1	LUN			0	Mode			
2	X'00' (Buffer ID)							
3	Buffer Offset (MSB)							
4	Buffer Offset							
5	Buffer Offset (LSB)							
6	Transfer Byte Length (MSB)							
7	Transfer Byte Length							
8	Transfer Byte Length (LSB)							
9	0	0	0	0	0	0	0	Link

This command is used in combination with the WRITE BUFFER command to diagnose the normalcy of the IDD's data buffer memory and the SCSI bus.

The functions of this command and the contents of the data transferred to the INIT are specified by the "Mode" field in the CDB and one of the transfer modes shown below can be selected.

"Mode" Bit	3	2	1	0	Transfer Mode
	0	0	0	0	Header + Data, without Address Specification
	0	0	0	1	Header + Data, with Address Specification
	0	0	1	0	Data Only, with Address Specification
	0	0	1	1	Buffer Descriptor
	1	0	1	0	Echo buffer
	1	0	1	1	Echo buffer descriptor

- (1) Mode = 0, 0, 0, 0: Header + data, without address specification

When this mode is specified, the data stored in the IDD's data buffer are transferred to the INIT after the 4-byte header. Zero must be specified in the "Buffer offset" field in the CDB.

The “Transfer byte count” field in the CDB specifies the total number of bytes of the header and buffer data which can be received by the INIT. The IDD reads the data from the data buffer from the top (Address X ‘000000’), then adds the 4-byte header to it and transfers it to the INIT. Data transfer is completed at the point when the number of bytes of the header and data from the IDD’s data buffer, specified in the “Transfer byte length” field, has been transferred, or at the point when transfer of the header and all the data in the IDD’s data buffer, to the final byte position, has been completed. When zero is specified in the “Transfer byte length” field, this command is terminated without executing a data transfer.

The format of the data transferred to the INIT when this mode is specified is shown in Figure 3.36.

		Bit							
		7	6	5	4	3	2	1	0
Header	0	0	0	0	0	0	0	0	0
	1	Effective Buffer Data Length (MSB)							
	2	Effective Buffer Data Length							
	3	Effective Buffer Data Length (LSB)							
Data	4	Buffer Data (Byte 0)							
	5	Buffer Data (Byte 1)							
	~	~							
	n	Buffer Data (Byte n-4)							

Figure 3.36 READ BUFFER command: buffer data (Mode = 0000, 0001)

The “Effective buffer data length” field in the header indicates the size of the data buffer (byte length). This value indicates the size of the IDD’s data buffer that can be used by the WRITE BUFFER and READ BUFFER commands without relation to the length specified in the “Transfer byte length” field in the CDB or the length of the data actually stored in the data buffer by the WRITE BUFFER command. When this mode is specified, the “Effective buffer data length” shows the size (cache segment volume) of the IDD’s entire data buffer area. Also, the length of the buffer data transferred to the INIT by this command is the value for the number of bytes in the [“Transfer byte length” field in the CDB – 4 bytes] or the value indicated in the “Effective buffer data length” field in the header, whichever is smaller.

- (2) Mode = 0, 0, 0, 1: Header + data, with address specification

The format of the data transferred to the INIT when this mode is specified is the same as the format of the data in the case of Mode = 0, 0, 0, 0, with the data stored in the IDD’s data buffer transferred to the INIT following the 4-byte header. In this mode, the address in the data buffer can be specified in the “Buffer offset” field in the CDB.

The “Transfer byte length” field in the CDB specifies the total number of bytes of header and buffer data that can be received by the INIT. The IDD reads the data from the data buffer beginning from the byte position in the data buffer specified in the “Buffer offset” field of the CDB and continuing in order, then adds the 4-byte header to it and transfers it to the INIT. Data transfer is completed at the point when the number of bytes of the header and data from the IDD’s data buffer, specified in the “Transfer byte length” field, has been transferred, or at the point when transfer of the header and all the data in the IDD’s data buffer, to the final byte position, has been completed. When zero is specified in the “Transfer byte length” field, this command is terminated without executing a data transfer.

The format and contents of the 4-byte header transferred in this mode are the same as in the case of Mode = 0, 0, 0, 0. However, the “Effective buffer data length” field in the header indicates the size (byte length) of the data from the byte position in the data buffer specified in the “Buffer offset” field in the CDB to the final byte position in the data buffer, including that byte. Also, the length of the buffer data transferred to the INIT by this command is the value for the number of bytes in [“Transfer byte length” field in the CDB – 4 bytes] or the value indicated in the “Effective buffer data length” in the header, whichever is smaller.

(3) Mode = 0, 0, 1, 0: Data only, with address specification

The data transferred to the INIT when this mode is specified is only the data which the IDD reads from the data buffer. The header is not transferred as it is in Mode = 0,0,0,0 and Mode = 0,0,0,1. In this mode, address in the data buffer can be specified in the “Buffer offset” field in the CDB.

The “Transfer byte length” field in the CDB specifies the total number of bytes of buffer data that can be received by the INIT. The IDD reads the data in order beginning from the byte position in the data buffer specified in the “Buffer address” field and transfers it to the INIT. Data transfer is completed at the point when the number of bytes of buffer data specified in the “Transfer byte length” field has been completed or transfer of the buffer data to the final byte position of the IDD’s data buffer is completed. When zero is specified in the “Transfer byte length” field, this command is terminated without executing a data transfer.

(4) Mode = 0, 0, 1, 1: Buffer descriptor

When this mode is specified, the IDD transfers only the 4-byte buffer descriptor to the INIT. the IDD’s data buffer attributes are indicated in the 4-byte buffer descriptor. Zero must be specified in the “Buffer offset” field in the CDB when this mode is specified. The IDD transfers the data length specified in the “Transfer byte length” field in the CDB or 4 bytes, whichever portion of data is smaller, to the INIT. When zero is specified in the “Transfer byte length” field, this command is terminated without executing a data transfer.

Byte \ Bit	7	6	5	4	3	2	1	0
0	X'xx' Addressing Boundary							
1	X'xx' Buffer Capacity (MSB)							
2	X'xx' Buffer Capacity							
3	X'xx' Buffer Capacity (LSB)							

Figure 3.37 READ BUFFER command: buffer descriptor

The "Addressing boundary" field in the buffer descriptor indicates the addressing boundary in the data buffer which can be specified in the WRITE BUFFER Command and the READ BUFFER Command as a "Power" when expressed as a "Power of 2." The IDD reports X'02' (=2²), indicating that it is possible to specify the address in 4-byte units. Also, the "Buffer capacity" field indicates the byte length of the size of the data buffer which can be operated by the WRITE BUFFER and READ BUFFER commands.

Note: Exercise caution regarding the following points when using this command.

If the WRITE BUFFER command or READ BUFFER command is used under a multi-initiator or multitask environment, it is necessary to be careful of the contents of the data buffer being changed by another initiator or a command that issues another task during the interval between completion of WRITE BUFFER command execution and execution of the READ BUFFER command.

- (5) Mode = 1, 0, 1, 0 : Echo buffer

In this mode the IDD transfers data to the INIT from the echo buffer. The echo buffer shall transfer the same data as when the WRITE BUFFER command with the mode field set to echo buffer was issued. The BUFFER ID and BUFFER OFFSET fields are ignored in this mode.

- (6) Mode = 1, 0, 1, 1 : Echo buffer descriptor

In this mode, a maximum of four bytes of READ BUFFER descriptor information is returned. The device server shall return the descriptor information for the echo buffer. The "Buffer Offset" field is reserved in this mode. The allocation length should be set to four or greater. The device server shall transfer the lesser of the allocation length or four bytes of READ BUFFER descriptor. The READ BUFFER descriptor is defined as shown in Figure 3.38.

Byte \ Bit	7	6	5	4	3	2	1	0
0	Reserved							EBOS
1	Reserved							
2	Reserved				Echo Buffer Capacity (MSB)			
3	Echo Buffer Capacity (LSB)							

Figure 3.38 READ BUFFER command: Echo buffer descriptor

The IDD return one in EBOS field, and the IDD verifies that echo buffer data from each initiator is the same as that previously written by the same initiator.

The "Buffer Capacity" field returns the size of the echo buffer X'01FC' in bytes aligned to a four-byte boundary.

3.4.5 READ LONG (3E)

Byte \ Bit	7	6	5	4	3	2	1	0
0	X'3E'							
1	LUN			0	0	0	CORRCT	0
2	Logical Block Address (MSB)							
3	Logical Block Address							
4	Logical Block Address							
5	Logical Block Address (LSB)							
6	0	0	0	0	0	0	0	0
7	Transfer Byte Length (MSB)							
8	Transfer Byte Length (LSB)							
9	0	0	0	0	0	0	0	Link

This command reads the logical data block data and its ECC byte, specified in the “Logical block address” field in the CDB, from the disk media and transfers it to the INIT. Normally, this command is used in combination with the WRITE LONG command to perform checks of the ECC function. The operation object in this command is 1 data block only.

Remark The Pad Byte and Sync Byte patterns are not included in the transfer data.

When “0” is specified in bit 1 of CDB byte 1, the “CORRCT (Corrected)” bit, the IDD does not implement ECC correction processing of data read from the disk media. When “1” is specified in the “CORRCT (Corrected)” bit, data errors that can be corrected by ECC are transferred to the INIT after being corrected in the IDD’s data buffer.

When a length (other than zero) which does not match the data format on the disk media is specified in the “Transfer byte length” field in the CDB, this command is terminated with a CHECK CONDITION status without executing a data transfer to the INIT. At this time, the sense data indicate the following contents and the INIT can determine the correct “Transfer byte length” from their contents.

- Sense key : 05 = ILLEGAL REQUEST
- Additional sense code/
Additional sense code qualifier : 24-00 = Invalid field in CDB
- “VALID” bit : “1”
- “ILI” bit : “1”
- Information field : (“Transfer byte length in the CDB) – (Original “Transfer byte length”)

Remark The calculation formula for the information field expresses 1 logical data block as n physical sectors, and when negative, as a complement of 2.

Error recovery processing during execution of this command is in accordance with the specifications in (Page code 1: Read/Write Error Recovery Parameter, Page code 21: Additional error recovery parameters).

- The ARRE flag and the DTE flag are not applied.
- The TB flag is treated as if “1” was specified.

3.4.6 WRITE LONG (3F)

Byte \ Bit	7	6	5	4	3	2	1	0
0	X'3F'							
1	LUN			0	0	0	0	0
2	Logical Block Address (MSB)							
3	Logical Block Address							
4	Logical Block Address							
5	Logical Block Address (LSB)							
6	0	0	0	0	0	0	0	0
7	Transfer Byte Length (MSB)							
8	Transfer Byte Length (LSB)							
9	0	0	0	0	0	0	0	Link

This command writes the data block data transferred from the INIT, together with the ECC to form bytes, in the logical data blocks on the disk media specified in the “Logical block address” field in the CDB. Normally, this command is used for checking the ECC function in combination with the READ LONG command.

The object of this command’s operation is only 1 data block. Also, the data transferred from the INIT by this command must have the same order and the same length as the data transferred to the INIT from the IDD by the READ LONG command.

The “Transfer byte length” field in the CDB indicates the number of bytes of data transferred from the INIT by this command. When the “Transfer byte length” specification is zero, this command is terminated normally without performing anything.

If a value specifying a length (other than zero) that does not match the data format on the disk media is specified in the “Transfer byte length” field in the CDB, that command is terminated with a CHECK CONDITION status without data being transferred to the INIT. The sense data at this time indicate the following contents and the INIT can determine the correct “Transfer byte length” from their contents.

- Sense key : 05 = ILLEGAL REQUEST
- Additional sense code/
Additional sense code qualifier : 24-00 = Invalid field in CDB
- “VALID” bit : “1”
- “ILI” bit : “1”
- Information field : (“Transfer byte length in the CDB) – (Original “Transfer byte length”)

Remark The calculation formula for the information field expresses 1 logical data block as n physical sectors and n sub-sectors, and when negative, as a complement of 2.

Error recovery processing during execution of this command is performed in accordance with the specifications in the MODE SELECT parameters (Page code 1: Read/Write Error Recovery Parameter, Page Code 21: Additional Error Recovery Parameter, but the AWRE flag and DTE flag are not applied.

3.4.7 WRITE SAME (41)

Byte \ Bit	7	6	5	4	3	2	1	0
0	X'41'							
1	LUN		0	0	PBdata	LBdata	RelAdr	
2	Logical Block Address (MSB)							
3	Logical Block Address							
4	Logical Block Address							
5	Logical Block Address (LSB)							
6	0	0	0	0	0	0	0	0
7	Number of Blocks (MSB)							
8	Number of Blocks (LSB)							
9	0	0	0	0	0	0	0	Link

This command requests that the device server write the single block of data transferred by the application client to the medium multiple times to consecutive multiple logical blocks.

A "Logical Block data (LBdata)" bit of zero and a "Physical Block data (PBdata)" bit of zero indicates that the single block of data transferred by the application client shall be used without modification. A "LBdata" bit of one requests that the device server replace the first four bytes of the data to be written to the current logical block with the logical block address of the block currently being written.

A "PBdata" bit of one requests that the device server replace the first eight bytes of the data to be written to the current physical sector with the physical address of the sector currently being written using the physical sector format.

The IDD is not supported a "PBdata" bit. Therefore, if "PBdata" bit is one, this command is terminated with CHECK CONDITION status (ILLEGAL REQUEST [=5] / Invalid field in CDB [=24-00]).

A "Relative Address (RelAdr)" bit of zero indicates that the "Logical Block Address" field specifies the first logical block of the range of logical blocks for this command.

A "RelAdr" bit of one indicates that the "Logical Block Address" field is a two's complement displacement. But the IDD is not supported this bit. Therefore, if this bit is one, this command is terminated with CHECK CONDITION status (ILLEGAL REQUEST [=5] / Invalid field in CDB [=24-00]).

The "Number of Blocks" field specifies the number of contiguous logical blocks to be written. A "Number of Blocks" field of zero requests that all the remaining logical blocks on the medium be written.

CHAPTER 4 Parameter Data Formats

4.1 Mode Parameters

4.2 Log Parameters

This chapter describes detailed parameter data formats provided by the IDD and how to use them.

4.1 Mode Parameters

This clause describes the block descriptors and the pages used with MODE SELECT and MODE SENSE commands that are applicable to all SCSI devices. Pages specific to each device type are described in the command standard that applies to that device type.

4.1.1 Read/Write error recovery parameters (page code = 1)

Figure 4.1 shows the format of the page descriptor of this MODE SELECT parameter.

Byte \ Bit	7	6	5	4	3	2	1	0
0	0	0	0	0	0	0	0	1
1	X'0A' or X'06' (Page Length)							
2	AWRE	ARRE	TB	RC	ERR	PER	DTE	DCR
Default	1	1	1	0	1	0	0	0
Variable	1	1	1	1	1	1	1	1
3	Number of retries during READ							
Default	X'3F' (=63 times)							
Variable	X'FF'							
4	Correctable Bit Length							
Default	X'FF' (MAWxxxx) / (MAXxxxx) (= over 255 bits)							
Variable	X'00'							
5	X'00' (Head Offset Count)							
6	X'00' (Data Strobe Offset Count)							
7	X'00' (Reserved)							
8	Number of retries during WRITE							
Default	X'3F' (=63 times)							
Variable	X'FF'							
9	X'00' (Reserved)							
10-11	Recovery Time Limit							
Default	X'7530' (=30 s)							
Variable	X'FFFF'							

(See the "Note")

Figure 4.1 MODE SELECT parameters: read/write error recovery parameters

Note:

If transfer of this page descriptor is requested by the MODE SENSE or MODE SENSE EXTENDED command, the IDD reports X'0A' as the page length (byte 1). However, if either X'0A' or X'06' is specified for the page length in the MODE SELECT or MODE SELECT EXTENDED command, the IDD treats it as though the correct page length was specified. If X'06' is specified for the page length, the value specified in the "Number of retries during READ" field is used as is in the "Number of retries during WRITE" field and the value specified in the "Number of retries during READ" field is also used as is in the "Number of retries during VERIFY" field. The X'06' page length is included in consideration of compatibility with previous models, but as much as possible, it is recommended that the INIT use the X'0A' page length.

Error recovery parameters defined in this page descriptor are applicable for the following commands, except in cases where it is specifically pointed out.

- READ
- READ EXTENDED
- READ LONG
- SEND DIAGNOSTIC (Write/read test)
- WRITE
- WRITE AND VERIFY (Write operation)
- WRITE EXTENDED
- WRITE LONG

a. AWRE (automatic write reallocation enabled)

"1" : An "automatic alternate block allocation processing" operation is specified during execution of a write operation.

"0" : An "automatic alternate block allocation processing" operation is prohibited during execution of a write operation.

Automatic alternate block allocation processing is explained in Section 5.3.2.

b. ARRE (automatic read reallocation enable)

"1" : An "automatic alternate block allocation processing" operation is specified during execution of a read operation.

"0" : An "automatic alternate block allocation processing" operation is prohibited during execution of a read operation.

Automatic alternate block allocation processing is explained in Section 5.3.2.

c. TB (transfer block)

"1" : Data blocks which contain errors that are impossible to correct are transferred to the INIT during a read operation.

"0" : Data blocks which contain errors that are impossible to correct are not transferred to the INIT during a read operation.

d. RC (read continuous)

This bit specifies continuous transfer of all the data requested by a command unaccompanied by a delay for executing error recovery processing.

e. EER (enable early recovery)

"1" : When a correctable data check has been detected, data correction according to the ECC is applied immediately without executing retry (rereading) up to the number of times specified in the "Number of retries during READ" parameter.

"0" : When a correctable data check has been detected, retry (rereading) is executed up to the number of times specified in the "Number of retries during READ" parameter, then data correction according to the ECC is applied if possible.

The IDD disregards this bit and operates according to the default value (=1).

f. PER (post error)

"1" : When several errors (errors related to the disk drive), which were recovered from normally through the IDD's error recovery processing, have been detected, a CHECK CONDITION status is reported when execution of that command is completed. In the sense data generated at this time, the sense key indicates "RECOVERED ERROR [=1]" and the content of the first error to be corrected successfully is reported.

"0" : Even when several errors (errors related to the disk drive), which were recovered from normally through the IDD's error recovery processing, have been detected, that command is completed with a GOOD status and the contents of the recovered errors are not reported.

g. DTE (disable transfer on error)

"1" : Even when several errors on the disk drive, which were recovered from normally through the IDD's error recovery processing, have been detected, execution of that command terminates at that point.

"0" : When several errors on the disk drive, which were recovered from normally through the IDD's error recovery processing, have been detected, execution of that command is continued.

The IDD disregards this bit and operates according to the default value (=0).

h. DCR (disable correction)

"1" : Even when a correctable data check has been detected, data correction according to the ECC is prohibited. However, On-the-fly correction processing is not prohibited.

"0" : When a correctable data check has been detected, data correction according to the ECC is applied.

The IDD disregards this bit and operates according to the default value (=0).

i. Number of retries during read

This parameter specifies the number of retries that should be executed for "Data Check" type errors detected in read operations on the disk media. The number of retries specified in this parameter is the maximum number of times reading is retried for each individual portion of data in each logical data block. If the IDD cannot perform correction of the data On-the-fly for each portion of data in the data block, it retries the reading of those portions. The reread retry is executed the number of times specified by the drive parameter internally by the IDD before this retry is executed, so actually the retry is executed the number specified here plus the number of internal retries.

The value specified in this parameter is applicable to the READ/READ EXTENDED commands and the read test in the SEND DIAGNOSTIC command.

When the page length in Page 1 is specified as X '06,' the value specified in this field is copied to the "Number of retries during WRITE" on this page and "Number of retries during VERIFY" on Page 7.

j. Correctable bit length

This parameter indicates the burst error length (bit length) which it is possible to apply data correction according to the ECC to. It is impossible to change this parameter from the INIT. The IDD disregards the value specified in this parameter and operates according to the "Default" value.

k. Head offset count (not supported)

This field specifies in two's-complement notation an incremental offset position from the track center to the radial position the heads are moved. Any value specified in this field does not preclude the device server from using positive or negative head offset during error recovery. However, after any error recovery is completed the device server returns the head offset to the value specified in this field.

The IDD is not supported this field. Therefore, the IDD ignores the specified value in this field.

l. Data strobe offset count (not supported)

This field specifies in two's-complement notation an incremental position to where the recovered data strobe is adjusted from its nominal setting. Any value specified in this field does not preclude the device server from using positive or negative data strobe offset during error recovery. However, after any error recovery is completed the device server returns the data strobe offset to the value specified in this field.

The IDD is not supported this field. Therefore, the IDD ignores the specified value in this field.

m. Number of retries during write

This field specifies the maximum number of times writing of data to the disk media is retried in the case that there has been an interruption in a write operation such as a shock. The number of retries specified in this field is applied to each logical block unit. When zero is specified in this field, retrying of writing to the disk is prohibited.

The value specified in this field is applicable to the WRITE command, WRITE EXTENDED command, write operation in the WRITE AND VERIFY command and write test in the SEND DIAGNOSTIC command. When the page length in Page 1 is specified as X '06,' the value specified in this field is not transferred from the INIT, but in this case, the value specified in the "Number of retries during READ," on the same page, is also applied to this field by the IDD.

n. Recovery time limit

This parameter specifies the maximum time that can be used by the TARG for error recovery processing, as a 1ms constant. The value specified in this parameter is the maximum permissible time for error recovery processing for each individual command. When both this parameter and the "Number of retries" parameter are specified, the parameter which specifies the shortest time must be given priority in application.

If less than 5000ms is specified, the IDD performs rounding processing and sets 5000ms.

Table 4.1 Combinations of error recovery flags (1 of 3)

EER	PER	DTE	DCR	Error Recovery Procedure
0	0	0	0	<ol style="list-style-type: none"> 1. Rereading is tried repeatedly up to the number of times specified in the "Read Retry Count", "Write Retry Count" or "Verify Retry Count" parameter. If possible, data correction is executed afterward according to the ECC. 2. When error recovery has succeeded, processing of the command is continued. 3. The contents of recovered errors are not reported. 4. If unrecoverable errors have been detected, execution of that command is terminated at that point. 5. Transfer of data in blocks which include unrecoverable errors to the INIT is done in accordance with the specification in the TB bit (read commands).
0	0	0	1	<ol style="list-style-type: none"> 1. Rereading is tried repeatedly up to the number of times specified in the "Read Retry Count", "Write Retry Count" or "Verify Retry Count" parameter. Data correction is not executed according to the ECC. 2. When error recovery has succeeded, processing of the command is continued. 3. The contents of recovered errors are not reported. 4. If unrecoverable errors have been detected, execution of that command is terminated at that point. 5. Transfer of data in blocks which include unrecoverable errors to the INIT is done in accordance with the specification in the TB bit (read commands).
0	0	1	0	(Setting prohibited) (See *1 at the end of this table.)
0	0	1	1	(Setting prohibited) (See *1 at the end of this table.)
0	1	0	0	<ol style="list-style-type: none"> 1. Rereading is tried repeatedly up to the number of times specified in the "Read Retry Count", "Write Retry Count" or "Verify Retry Count" parameter. If possible, data correction is executed afterward according to the ECC. 2. When error recovery has succeeded, processing of the command is continued. 3. If unrecoverable errors have been detected, execution of that command is terminated at that point. 4. Transfer of data in blocks which include unrecoverable errors to the INIT is done in accordance with the specification in the TB bit (read commands). 5. When recovery from all detected errors has been successful, a CHECK CONDITION status (RECOVERED ERROR [=1]) is reported after all processing of the command is completed and the sense data indicate the content of the last error that was successfully recovered from and the address of the data block where that error occurred.
0	1	0	1	<ol style="list-style-type: none"> 1. Rereading is tried repeatedly up to the number of times specified in the "Read Retry Count", "Write Retry Count" or "Verify Retry Count" parameter. Data correction is not executed according to the ECC. 2. When error recovery has succeeded, processing of the command is continued. 3. If unrecoverable errors have been detected, execution of that command is terminated at that point. 4. Transfer of data in blocks which include unrecoverable errors to the INIT is done in accordance with the specification in the TB bit (read commands). 5. When recovery from all detected errors has been successful, a CHECK CONDITION status (RECOVERED ERROR [=1]) is reported after all processing of the command is completed and the sense data indicate the content of the last error that was successfully recovered from and the address of the data block where that error occurred.

Table 4.1 Combinations of error recovery flags (2 of 3)

EER	PER	DTE	DCR	Error Recovery Procedure
0	1	1	0	<ol style="list-style-type: none"> 1. Rereading is tried repeatedly up to the number of times specified in the "Read Retry Count", "Write Retry Count" or "Verify Retry Count" parameter. If possible, data correction is executed afterward according to the ECC. 2. When error recovery has succeeded, or even when recovery is impossible, execution of the command is terminated with a CHECK CONDITION status at the point when error recovery processing is completed, and the sense data indicate the data block address where that error occurred. 3. Transfer to the INIT of data in blocks with recovered errors is done, but transfer to the INIT of data blocks in which the errors were unrecoverable is done in accordance with the specification in the TB bit (read commands).
0	1	1	1	<ol style="list-style-type: none"> 1. Rereading is tried repeatedly up to the number of times specified in the "Read Retry Count", "Write Retry Count" or "Verify Retry Count" parameter. Data correction is not executed according to the ECC. 2. When error recovery has succeeded, or even when recovery is impossible, execution of the command is terminated with a CHECK CONDITION status at the point when error recovery processing is completed, and the sense data indicate the data block address where that error occurred. 3. Transfer to the INIT of data in blocks with recovered errors is done, but transfer to the INIT of data blocks in which the errors were unrecoverable is done in accordance with the specification in the TB bit (read commands).
1	0	0	0	<ol style="list-style-type: none"> 1. When a correctable data check is detected, immediately, correction is executed according to the ECC. For data checks which cannot be corrected, rereading is tried repeatedly up to the number of times specified in the "Read Retry Count", "Write Retry Count" or "Verify Retry Count" parameter. However, if a correctable error is detected during reading, data correction is executed at that point according to the ECC. 2. When error recovery has succeeded, processing of the command is continued. 3. The contents of recovered errors are not reported. 4. If unrecoverable errors have been detected, execution of that command is terminated at that point. 5. Transfer of data in blocks which include unrecoverable errors to the INIT is done in accordance with the specification in the TB bit (read commands).
1	0	0	1	(Setting prohibited) (See *1 at the end of this table.)
1	0	1	0	(Setting prohibited) (See *1 at the end of this table.)
1	0	1	1	(Setting prohibited) (See *1 at the end of this table.)

Table 4.1 Combinations of error recovery flags (3 of 3)

EER	PER	DTE	DCR	Error Recovery Procedure
1	1	0	0	<ol style="list-style-type: none"> 1. When a correctable data check is detected, immediately, correction is executed according to the ECC. For data checks which cannot be corrected, rereading is tried repeatedly up to the number of times specified in the "Read Retry Count", "Write Retry Count" or "Verify Retry Count" parameter. However, if a correctable error is detected during reading, data correction is executed at that point according to the ECC. 2. When error recovery has succeeded, processing of the command is continued. 3. If unrecoverable errors have been detected, execution of that command is terminated at that point. 4. Transfer of data in blocks which include unrecoverable errors to the INIT is done in accordance with the specification in the TB bit (read commands). 5. When recovery from all detected errors has been successful, a CHECK CONDITION status (RECOVERED ERROR [=1]) is reported after all processing of the command is completed and the sense data indicate the content of the last error that was successfully recovered from and the address of the data block where that error occurred. However, if the error is corrected with ECC only, the CHECK CONDITION is not reported and no sense data is created.
1	1	0	1	(Setting prohibited) (See *1 at the end of this table.)
1	1	1	0	<ol style="list-style-type: none"> 1. When a correctable data check is detected, immediately, correction is executed according to the ECC. For data checks which cannot be corrected, rereading is tried repeatedly up to the number of times specified in the "Read Retry Count", "Write Retry Count" or "Verify Retry Count" parameter. However, if a correctable error is detected during reading, data correction is executed at that point according to the ECC. 2. When error recovery has succeeded, or even when recovery is impossible, execution of the command is terminated with a CHECK CONDITION status at the point when error recovery processing is completed, and the sense data indicate the data block address where that error occurred. 3. Transfer to the INIT of data in blocks with recovered errors is done, but transfer to the INIT of data blocks in which the errors were unrecoverable is done in accordance with the specification in the TB bit (read commands).
1	1	1	1	(Setting prohibited) (See *1 at the end of this table.)

*1 If a setting-prohibited combination of error recovery flags is specified, the MODE SELECT or MODE SELECT EXTENDED command is terminated with a CHECK CONDITION status (ILLEGAL REQUEST [=5] / Invalid field in parameter list [=26-00]) and all the parameters specified at that time are disabled.

Remark:

Just as explained for the EER, PER, DTE and DCR bits, the IDD can only make a valid specification for the PER bit. Therefore, among the error recovery flag combinations listed above, the only one which can actually operated is (EER, PER, DTE, DCR) = (1, 0, 0, 0) and (1, 1, 0, 0).

4.1.2 Disconnect/reconnect parameters (page code = 2)

The format of the page descriptor in this MODE SELECT parameter is shown in Figure 4.2.

Bit Byte	7	6	5	4	3	2	1	0	
0	0	0	0	0	0	0	1	0	
1	X'0E' or X'0A' (Page Length)								(See the "Note.")
2	Buffer Full Ratio								
Default	X'00'								
Variable	X'FF'								
3	Buffer Empty Ratio								
Default	X'00'								
Variable	X'FF'								
4-5	Bus Inactivity Limit								
Default	X'0001'								(=100 μs)
Variable	X'0000'								
6-7	Disconnect Time Limit								
Default	X'0000'								
Variable	X'0000'								
8-9	Connect Time Limit								
Default	X'0000'								
Variable	X'0000'								
10-11	Maximum Burst Size								
Default	X'0000'								
Variable	X'0000'								
12	EMDP	FAIR ARBITRATION			DImm	DTDC			
Default	0	1	1	1	0	0	0	0	
Variable	0	1	1	1	0	0	1	1	
13-15	X'000000' (Reserved)								

Figure 4.2 MODE SELECT parameters: disconnect/reconnect parameters

Note:

If transfer of this page descriptor is required by the MODE SENSE or MODE SENSE EXTENDED command, the IDD reports X '0E' as the page length (byte 1). However, if either X '0E' or X '0A' is specified for the page length in the MODE SELECT command, the IDD regards it as if the correct page length was specified. The X '0A' page length, is provided in consideration of compatibility with previous models, but it is recommended that the page length X '0E' be used by the INIT to support expansions in the specifications in the future.

See Section 2.1, "Data Buffer" concerning specification methods for the "Buffer Full Ratio" and "Buffer Empty Ratio" parameters in this page descriptor and details of data buffer operation.

a. Buffer full ratio

This parameter specifies the timing for the IDD to start reconnection processing in order to transfer data to the INIT by the READ or READ EXTENDED command.

The value specified in this parameter (n) shows the amount of data read to the IDD's data buffer from the disk media as a proportion [n/256] of the total capacity of the data buffer until reconnection processing with the SCSI bus is started. **(Note)**

If it is possible to transfer the amount of data specified in this parameter to the INIT from the data buffer, reconnection processing is executed and transfer of data to the INIT begins.

The default value for this parameter is X'00'. The host can also specify X'00' for this parameter. If X'00' is specified, the IDD assigns an appropriate value for this parameter that is determined by IDD.

b. Buffer empty ratio

This parameter specifies the timing for the IDD to start reconnection when it is requested by the INIT to transfer data in the WRITE, WRITE EXTENDED or WRITE AND VERIFY command.

The value specified in this parameter (n) indicates the size of the empty area in the IDD's data buffer as a proportion of the total data buffer capacity of the IDD [n/256]. **(Note)**

While the IDD is writing data to the disk media, it is using the data pre-fetched to the data buffer in order, and when the empty space in the data buffer reaches the amount specified in this parameter, it executes reconnection processing, requesting transfer of the succeeding data.

If the total number of bytes in the transferred data block count specified in the command is less than the capacity of the buffer segment, all the data are pre-fetched in a batch, so the specification in this parameter is not applied.

The default value for this parameter is X'00'. The host can also specify X'00' for this parameter. If X'00' is specified, the IDD assigns an appropriate value for this parameter that is determined by IDD.

Note:

If the value specified for the "buffer full ratio" or the "buffer empty ratio" is not within double the integral boundary of the logical data block length, the IDD rounds up the specified value to the value which is the nearest data block boundary. Also, if zero is specified in any of these parameters. If X'00' is specified, the IDD assigns an appropriate value for this parameter that is determined by IDD. However, parameter values specified from the INIT in the MODE SELECT or MODE SELECT EXTENDED command are held as is and those values are reported in response to a MODE SENSE or MODE SENSE EXTENDED command. (Rounding processing of the parameters is not done by the IDD.)

c. Bus inactivity limit

This parameter indicates the maximum time that the TARG is permitted to keep the SCSI bus in the busy state (BSY signal = TRUE) without executing a REQ/ACK handshake, in multiples of 100 μ s. In the IDD, this value is 100 μ s during normal operation. It is impossible for this parameter to be changed by the INIT. The IDD disregards the value specified in this parameter and operates according to the "Default" value.

d. Disconnect time limit

This parameter specifies the maximum time that the TARG is permitted to continue in the disconnect state until it starts reconnect processing, in multiples of 100 μ s.

In the IDD, this value is 0 μ s. It is impossible for this parameter to be changed by the INIT. The IDD disregards the value specified in this parameter and operates according to the "Default" value.

e. Connect time limit

This parameter specifies the maximum time that the TARG is permitted to use the SCSI bus until it starts disconnect processing, in multiples of 100 μ s.

In the IDD, this value is unlimited. It is impossible for this parameter to be changed by the INIT. The IDD disregards the value specified in this parameter and operates according to the "Default" value.

f. Maximum burst size

This parameter specifies the maximum volume of data the TARG is permitted to transfer continuously in the DATA IN phase or the DATA OUT phase until it starts disconnect processing, in multiples of number of bytes per sector.

In the IDD, this value is unlimited. It is impossible for this parameter to be changed by the INIT. The IDD disregards the value specified in this parameter and operates according to the "Default" value.

g. Data transfer disconnect control (DTDC)

DTDC: Controls how to perform disconnection.

00b= Perform disconnection according to the instructions of other parameters without using DTDC.

01b= When a data transfer by the command is started, the target will never try disconnection until transmission of all the data to be transferred by the command is completed. The specified values in the "connect limit time" and "bus inactivity limit" fields are ignored during the data transfer.

10b= Reserved.

11b= When a data transfer by the command is started, the target will never try disconnection until execution of the command is completed. The specified values in the "connect limit time" and "bus inactivity limit" fields are ignored during the data transfer.

h. Disconnect Immediate (DImm) (Not supported)

The IDD always control disconnection with itself algorithm. Therefore, The IDD disregards the value specified in this parameter, and operates according to the "Default" value.

"0" : The IDD transfers data for a command during the same interconnect tenancy in which it receives the command. Whether or not the target does so may depend upon the target's internal algorithms, the rules of the applicable SCSI protocol, and settings of the other parameters in this mode page.

"1" : The IDD does not transfer data for a command during the same interconnect tenancy in which it receives the command.

i. Fair arbitration

This field indicates whether the target uses fair or unfair arbitration when requesting an interconnect tenancy.

"000b" : Cannot use the arbitration fairness during a normal arbitration.

except above : Can use the arbitration fairness during a normal arbitration.

j. Enable modify data pointer (EMDP) (Not supported)

This bit indicates whether or not the initiator allows the data transfer to be re-ordered by the target.

The IDD are not supported a MODIFY DATA POINTER message. Therefore, The IDD disregards the value specified in this bit, and operates according to the "Default" value.

"0" : The IDD cannot transfer a MODIFY DATA POINTER message.

"1" : The IDD can transfer a MODIFY DATA POINTER message.

4.1.3 Format parameter (page code = 3)

The Page descriptor format of this MODE SELECT parameter is shown in Figure 4.3.

Byte \ Bit	7	6	5	4	3	2	1	0
0	0	0	0	0	0	0	1	1
1	X'16' (Page Length)							
2-3	Track Count/Zone							
Default	X'xxxx'							
Variable	X'0000'							
4-5	Alternate Sector Count/Zone							
Default	X '00F0' (MAWxxxx) or X '00C8' (MAXxxxx)							
Variable	X'FFFF'							
6-7	Alternate Track Count/Zone							
Default	X'0000'							
Variable	X'0000'							
8-9	Alternate Track Count/Drive							
Default	X'xxxx'							
Variable	X'0000'							
10-11	Sector Count/Track							
Default	X'xxxx'							
Variable	X'0000'							
12-13	Data Byte Length/Physical Sector							
Default	X'0200'							
Variable	X'FFFF'							
14-15	Interleave Factor							
Default	X'0001'							
Variable	X'0000'							
16-17	Track Skew Factor							
Default	X'xxxx'							
Variable	X'0000'							
18-19	Cylinder Skew Factor							
Default	X'xxxx'							
Variable	X'0000'							
20	SSEC	HSEC	RMB	SURF	0	0	0	0
Default	0	1	0	0	0	0	0	0
Variable	0	0	0	0	0	0	0	0
21-23	X'000000' (Reserved)							

Figure 4.3 MODE SELECT parameters: format parameters

- a. Parameters for specifying alternate processing areas for defective blocks (bytes 2 to 9)

The following 4 parameters specify the position and number of spare sectors for performing defective block alternate allocation processing on the disk media. See Chapter 3, "Data Format" of Product Manual for details of the IDD's alternate block processing.

- Track count/zone

This parameter specifies the number of tracks a unit for alternating blocks. The INIT cannot clearly specify this value. The IDD ignores the specification for this bit. If the value of the Active Notch in Page C is 0, the "Number of tracks a cell" is reported for the MODE SENSE and MODE SENSE EXTENDED commands.

If not, the total number of track of the zone which is specified as the Active Notch is reported.

- Alternate sector count/zone

This parameter specifies the number of sectors per one cell as the number of spare sectors secured for use as alternate blocks. In the IDD, this parameter indicates the number of spare sectors secured in each cell. The maximum permissible value of this parameter either the "number of physical sectors per track in the last cell - 1" or "240", whichever is smaller. It is possible for the INIT to vary this parameter within a range of 0 to the maximum permissible value. When a value which exceeds the maximum permissible value is specified, the IDD performs rounding down of the parameter and sets a value equal to this parameter's maximum permissible value. If the above rounding processing is performed, a CHECK CONDITION status (RECOVERED ERROR [= 1] / Rounded parameter [37-00]) is reported for that command.

- Alternate track count / zone

This parameter specifies the area secured for alternate blocks as the number of tracks per one cell. It is impossible to change this parameter. When a value other than zero is specified in this field, the IDD performs rounding down processing of this parameter and always sets this parameter value at zero.

- Alternate track count / drive

This parameter specifies the area secured for alternate blocks as the number of tracks per disk drive. In the IDD, this parameter indicates the number of tracks in the spare area secured as alternate cells. This value is fixed at a value that equals the number of tracks per cylinder multiplied by the number of zones in the IDD. This parameter cannot be changed by the INIT.

- b. Parameters specifying track format (bytes 10, 11)

- Sector count/track

This parameter specifies the number of physical sectors per 1 track. In the IDD, the number of physical sectors in a track is set unilaterally according to the data format specified by the "Data Block Length" parameter in the block descriptor or the "Data byte length/Physical sector" parameter in this page descriptor, so this parameter cannot be changed. The IDD disregards the value specified in this field. This parameter indicates the value of zone specified in Active Notch of Page C. If it is 0, this parameter indicates the value in zone 0.

c. Parameters specifying sector format (bytes 12 to 19)

- Data byte length/physical sectors

This parameter specifies the data length per 1 physical sector as the number of bytes. In the IDD, the data byte length per 1 physical sector is the same as the data byte length in 1 logical data block. The INIT can specify the value of this parameter at 0 or 512 to 528 bytes (4-byte boundary).

If a value less than 512 bytes, the IDD sets a byte length of 512. If more than 528 bytes is specified, the IDD performs rounding processing and sets a byte length of 528. If an odd number of bytes is specified within the specified range, the IDD performs rounding up processing. If the above rounding processing is performed, the IDD reports the CHECK CONDITION status (RECOVERED ERROR [=1] / Rounded parameter [37-00] for that command.

If 0 is specified in this parameter, the value calculated based on the value of the "Data block length" in the block descriptor is used as this parameter value.

When both this page descriptor and the block descriptor are specified by the same MODE SELECT command, and a nonzero value is specified in this parameter which differs from the value in the "Data block length" parameter in the block descriptor, the value specified in the block descriptor has priority.

- Interleave factor

This parameter field has meaning only with the MODE SENSE and MODE SENSE EXTENDED commands. The interleave factor (in the IDD, this is always X '0001' :non interleave) of the disk drive's current data format. The value specified in this field is disregarded in the MODE SELECT and MODE SELECT EXTENDED commands.

- Track skew factor

This parameter indicates the number of physical sectors existing between the data block with the highest order logical block address on a track and the data block with the next logical block address on the next track of the same cylinder (track skew). This parameter cannot be changed. The IDD disregards the value specified in this field and sets the optimum track skew value in the specified data block length. See Chapter 3, "Data Format" in the Product Manual for details about track skew. This parameter indicates the value of zone specified in active notch of Page C. If it is 0, this parameter indicates the value in zone 0.

- Cylinder skew factor

This parameter indicates the number of physical sectors existing between the data block with the highest order logical block address in a cylinder and the data block with the next logical block address in the next cylinder (cylinder skew). This parameter cannot be changed. The IDD disregards the value specified in this field and sets the optimum cylinder skew value in the specified data block length. See Chapter 3, "Data Format" in the Product Manual for details about cylinder skew. This parameter indicates the value of zone specified in active notch of Page C. If it is 0, this parameter indicates the value in zone 0.

d. Parameters related to device type (byte 20)

- SSEC (soft sectoring)

When this bit is "1," it indicates that the data formatting method on the disk media is "soft sectoring." However, since the IDD uses only the "hard sectoring" method (refer to previously shown item b), this bit is disregarded. Furthermore, it is impossible to change this parameter.

- **HSEC (hard sectoring)**
When this bit is "1," it indicates that the data formatting method on the disk media is "hard sectoring." However, since the IDD uses only the "hard sectoring" method, this bit is disregarded. Furthermore, it is impossible to change this parameter.
- **RMB (removable medium)**
When this bit is "1," it indicates that the storage media of the disk drive can be replaced. When this bit is "0," it indicates that the storage media is fixed. However, since the IDD has a fixed media, this bit is disregarded. Furthermore, it is impossible to change this parameter.
- **SURF (surface addressing)**
When this bit is "1," it indicates that after logical data block address allocation is performed over all the sectors in order on the same memory surface (same head), it is proceeding to the next memory surface (next head) after all the sectors have been done. When this bit is "0," it indicates that after logical data block address allocation is performed over all the sectors in order in the same cylinder (all heads), it is proceeding to the next cylinder. In the IDD, only the latter type of addressing is possible, so this bit is disregarded. It is also impossible to change this parameter.

Figure 4.4 shows each parameter of pages 3, 4, and C in detail. (The contents are subject to change without notice.)

	Page 3					Page 4		Page C			
	Byte 2-3	Byte 8-9	Byte 10-11	Byte 16-17	Byte 18-19	Byte 2-4	Byte 5	LPN=0 (Default)		LPN=1	
	Number of tracks/zone	Number of alternate tracks/drive	Number of sectors/track	Track skew factor	Cylinder skew factor	Number of cylinders	Number of heads	Starting boundary	Ending boundary	Starting boundary	Ending boundary
MAW3300 (Sector length = 512)	0x00E8	0x0090	0x048D	0x0124	0x0071	0x0133A1	0x08	0x00000000	0x0133A007	0x00000000	0x22EF6677
MAW3147 (Sector length = 512)	0x0091	0x005A	0x048D	0x0124	0x0071	0x0133A1	0x05	0x00000000	0x0133A004	0x00000000	0x15DIE58C
MAW3073 (Sector length = 512)	0x003A	0x0024	0x048D	0x0124	0x0071	0x0133A1	0x02	0x00000000	0x0133A001	0x00000000	0x08B464A1
MAX3147 (Sector length = 512)	0x00D8	0x0090	0x035F	0x00D8	0x006F	0x00C006	0x08	0x00000000	0x00C00507	0x00000000	0x1133BDD7
MAX3073 (Sector length = 512)	0x006C	0x0048	0x035F	0x00D8	0x006F	0x00C006	0x04	0x00000000	0x00C00503	0x00000000	0x089717FB
MAX3036 (Sector length = 512)	0x0036	0x0024	0x035F	0x00D8	0x006F	0x00C006	0x02	0x00000000	0x00C00501	0x00000000	0x0448C50D

Figure 4.4 MODE SELECT parameters: each parameters of pages 3, 4, and C in detail

4.1.4 Drive parameter (page code = 4)

The page descriptor format of this MODE SELECT parameter is shown in Figure 4.5.

Byte \ Bit	7	6	5	4	3	2	1	0
0	0	0	0	0	0	1	0	0
1	X'16', X'12' or X'0A' (Page Length)							
2-4	Cylinder Count							
Default	X'xxxxxx'							
Variable	X'000000'							
5	Number of Heads							
Default	X'xx'							
Variable	X'00'							
6-8	"Write Precompensation" Starting Cylinder							
Default	X'000000'							
Variable	X'000000'							
9-11	"Reduced Write Current" Starting Cylinder							
Default	X'000000'							
Variable	X'000000'							
12-13	Drive Step Rate							
Default	X'0000'							
Variable	X'0000'							
14-16	Landing Zone Cylinder							
Default	X'000000'							
Variable	X'000000'							
17	0	0	0	0	0	0	RPL	
Default	0	0	0	0	0	0	0	0
Variable	0	0	0	0	0	0	0	0
18	Rotational Synchronization Offset							
Default	X'00'							
Variable	X'00'							
19	X'00' (Reserved)							
20-21	Rotational Speed							
Default	X'2729' or X'3A98'							
Variable	X'0000'							
22-23	X'0000' (Reserved)							

(See the "Note")

(10,025 rpm or 15,000 rpm)

Figure 4.5 MODE SELECT parameters: drive parameters

Note:

When transfer of this page is requested by the MODE SENSE or MODE SENSE EXTENDED command, the IDD reports X'16' as the page length. However, in the MODE SELECT and MODE SELECT EXTENDED commands, if either X'16,' X'12' or X'0A' is specified, it is treated as if the IDD has specified the correct page length. The X'12' and X'0A' page lengths have been included in consideration of compatibility with previous models, but it is recommended that the INIT use the X'16' page length to support expanded specifications in the future.

a. Cylinder count

This parameter specifies the total number of cylinders configured in the user space on the disk media. This value includes the number of cylinders for alternate blocks specified in the "Alternate Track Count/Drive" parameter of the format parameters (Page code = 3). It is impossible to change this parameter.

b. Number of heads

This parameter indicates the number of data Read/Write heads in the disk drive. It is impossible to change this parameter.

c. Bytes 6 to 16

The parameter defined in bytes 6 to 16 of this page descriptor is a parameter that it is clearly not necessary for the INIT to specify. The IDD disregards the values specified in this field.

d. RPL (rotational position locking)

These bits are used for rotational synchronization of the disk and can be specified. The IDD disregards the value specified in this field.

e. Rotational synchronization offset

This is a field which specifies the offset value used for rotational synchronization of the disk, but it is not supported in the IDD. The IDD disregards the value specified in this field.

f. Rotational speed

This specifies the disk's rotational speed in rpm (rotations/minute). This parameter cannot be changed by the INIT. The IDD disregards the value specified in this field and operates according to the "Default" value.

4.1.5 Verify error recovery parameters (page code = 7)

The page descriptor format of this MODE SELECT parameter is shown in Figure 4.6.

Byte \ Bit	7	6	5	4	3	2	1	0	
0	0	0	0	0	0	1	1	1	
1	X'0A' (Page Length)								(See the Note.)
2	(Reserved)				EER	PER	DTE	DCR	
Default	0	0	0	0	1	0	0	0	
Variable	0	0	0	0	1	1	1	1	
3	Number of retries during VERIFY.								
Default	X'3F'								
Variable	X'FF'								
4	Correctable Bit Length								
Default	X'FF' (MAWxxxx) / (MAXxxxx) (= over 255 bits)								
Variable	X'00'								
5-9	X'000000000' (Reserved)								
10-11	Recovery Time Limit								
Default	X'7530'								
Variable	X'FFFF'								

Figure 4.6 MODE SELECT parameters: verify error recovery parameters

The error recovery parameters divided in this page descriptor are applicable for the following commands.

- VERIFY
- WRITE AND VERIFY (verify operation)

Note:

If selecting the SCSI-1/CCS mode in the CHANGE DEFINITION command specification, use Page code = 1 (Read/Write Error Recovery Parameters) instead of this parameter.

a. Error recovery flags

- EER (enable early recovery)
- PER (post error)
- DTE (disable transfer on error)
- DCR (disable correction)

The definitions and functions of these control flags are the same as for the read/write error recovery parameters. See item (1) concerning the details.

b. Number of retries during VERIFY

This parameter specifies the number of times reading of the disk media should be retried when a "Data Check" type error is detected in a read operation. The number of retries specified by this parameter is the maximum number of times reading of each individual data area in each logical data block is retried. The IDD retries reading the data area in each data block the specified number of times. When zero is specified in this field, retrying to read data from the disk is prohibited.

When X '06' is specified as the page length on Page 1, the IDD applies the value specified in the Number of retries during READ field on Page 1 to this field also.

c. Correctable bit length

This parameter indicates the burst error length (bit length) that can be applied for data corrections according to the ECC. This parameter cannot be changed by the INIT. However, the IDD disregards the value specified in this parameter and operations according to the "Default" value.

d. Recovery time limit

This parameter specifies the maximum time the TARG can be used for error recovery processing, as a 1ms constant. The value specified in this parameter is the maximum permissible error recovery processing time for an individual command. When both this parameter and the "Number of retries during VERIFY" parameter are specified, priority must be given to whichever parameter specifies the shortest time in its application.

The reported value in this field is a copy of the Recovery time limit in Page 1. The IDD disregards the value specified in this field.

4.1.6 Caching parameters (page code = 8)

The page descriptor format of this MODE SELECT parameter is shown in Figure 4.7.

Byte \ Bit	7	6	5	4	3	2	1	0
0	0	0	0	0	1	0	0	0
1	X'0A' or X'12' (Page Length)							
2	IC	ABPF	CAP	DISC	SIZE	WCE	MS	RCD
Default	0	0	0	1	0	1	0	0
Variable	1	0	0	0	0	1	0	1
3	Demand Read Retention Priority				Write Retention Priority			
Default	0	0	0	0	0	0	0	0
Variable	0	0	0	0	0	0	0	0
4-5	Pre-fetch inhibit block count							
Default	X'FFFF'							
Variable	X'0000'							
6-7	Minimum pre-fetch							
Default	X'0000'							
Variable	X'0000'							
8-9	Maximum pre-fetch							
Default	X'0000'							
Variable	X'0000'							
10-11	Maximum pre-fetch limit block count							
Default	X'FFFF'							
Variable	X'0000'							
12	FSW	LBCSS	DRA	VS	VS	(Reserved)		
Default	1	0	0	0	0	0	0	0
Variable	0	0	0	0	0	0	0	0
13	Cache Segment Count							
Default	X'08'							
Variable	X'3F'							
14-15	Cache Segment Size							
Default	X'0000'							
Variable	X'0000'							
16	X'00' (Reserved)							
17-19	Non Cache Segment Size							
Default	X'000000'							
Variable	X'000000'							

Figure 4.7 MODE SELECT parameters: caching parameters

The parameters defined in this page descriptor control the range of look-ahead data in the Look-Ahead cache feature and enable or disable the caching operation. See Section 2.2, "Look-Ahead Cache Feature" and Section 2.3, "Write Cache" concerning details of the Look-Ahead cache feature and parameter setting methods.

a. RCD (read cache disable)

This bit can be specified, and its operation is as specified.

This bit specifies whether or not to activate the cache operation for a read command.

"1" : Prohibits operation of the Look-Ahead cache function.

The IDD reads ahead all of the data requested by the READ command or READ EXTENDED command from the disk and transfers it to the INIT. Moreover, it does not read ahead data blocks after the requested data.

"0" : Specifies operation of the Look-Ahead cache function.

If part or all of the data, including logical data blocks of headers, requested by a READ command or READ EXTENDED command exists in the data buffer, the IDD transfers that data without accessing the disk. Also, depending on the instructions for the bytes beyond byte 4 of the parameter page, it reads ahead the data blocks after the requested data in the data buffer.

b. Multiple selection (MS)

This bit specifies how to specify the "minimum prefetch count" (bytes 6 and 7) and "maximum prefetch count" (bytes 8 and 9) parameters in this page descriptor.

1: The "minimum prefetch count" and "maximum prefetch count" parameters indicate a multiplier. The number of data blocks to be prefetch is calculated that the value in the "transfer byte count" in the CDB specified by the READ or READ EXTENDED command X multiplier.

0: The "minimum prefetch count" and "maximum prefetch count" parameters indicate the data block count to be prefetched with the logical data block count.

This bit cannot be changed, and the IDD ignores this bit specification and operates according to the default value ('0').

c. WCE (write cache enable)

This bit can be specified, and its operation is as specified.

This bit specifies whether or not to activate the cache operation for a write command.

"1" : This enables the write cache.

Write data remains in the buffer memory, the cache is made the object even for a read command, and when all of the write data has been received, "GOOD" status is reported without disconnecting.

Sequential writing is performed without waiting for rotation.

"0" : This prohibits operation of the write cache function.

Write data remains in the buffer memory, the cache is not made the object even for a read command, and as soon as all the data has been written to the disk, "GOOD" status is reported.

d. SIZE (size enable) (not supported)

"1" : Divides the data buffer in accordance with the value specified for the cache segment size (bytes 14, 15).

"0" : Divides the data buffer in accordance with the value specified for the number of cache segments (byte 13).

This bit cannot be changed. The IDD disregards the specification in this bit and operates according to the "Default" value (= "0").

e. DISC (discontinuity)

"1" : Even if a track switch occurs during Look-Ahead, the Look-Ahead operation continues without interruption.

"0" : Look-Ahead is terminated at the point where track switch occurs during Look-Ahead.

This bit cannot be changed. The IDD disregards the specification in this bit and operates according to the "Default" value (= "1").

f. IC (initiator control enable)

"1" : Dividing of cache segments is according to the SIZE bit specification.

"0" : Dividing of the cache segments is performed by an algorithm that is inherent in the IDD.

The IDD disregards this bit and operates according to the default value (= "0").

g. Demand Read Retention Priority (not supported)

This field advises the device server the retention priority to assign for data read into the cache that has also been transferred from the logical unit to the application client.

The IDD are not supported this field. Thus, the IDD disregards the specification in this field.

"F" : Data put into the cache via a READ command was not replaced if there is other data in the cache that was placed into the cache by other means and it may be replaced.

"1" : Data put into the cache via a READ command was replaced sooner than data placed into the cache by other means.

"0" : Indicates the device server was not distinguish between retaining the indicated data and data placed into the cache memory by other means.

h. Write Retention Priority (not supported)

This field advises the device server the retention priority to assign for data written into the cache that has also been transferred from the cache memory to the medium.

"F" : Data put into the cache during a WRITE or WRITE and VERIFY command was not replaced if there is other data in the cache that was placed into the cache by other means and it may be replaced.

"1" : Data put into the cache during a WRITE or WRITE and VERIFY command was replaced sooner than data placed into the cache by other means.

"0" : Indicates the device server was not distinguish between retaining the indicated data and data placed into the cache memory by other means.

i. Pre-fetch inhibit block count (not supported)

This parameter is used to selectively prohibit data Look-Ahead operations in the READ command or the READ EXTENDED command. When the "Transfer block count" specified in the CDB of the READ command or the READ EXTENDED command is greater than the value in this parameter, data Look-Ahead operations are not executed in that command. This bit cannot be changed. The IDD disregards the specification in this bit and operates according to the "Default" value (= X 'FFFF').

j. Minimum pre-fetch (not supported)

This parameter specifies the minimum quantity of logical data blocks pre-fetched to the data buffer with the READ command or READ EXTENDED command.

This parameter cannot be changed. The IDD disregards the specification in this field.

k. Maximum pre-fetch (not supported)

This parameter specifies the maximum quantity of logical data blocks pre-fetched to the data buffer with the READ command or READ EXTENDED command.

The IDD varies the pre-fetch volume according to the volume of data requested by the READ command or READ EXTENDED command. The value reported to the MODE SENSE command always indicates the number of blocks corresponding to 1 cache segment – 1.

This parameter cannot be changed. The IDD disregards the specification in this field.

l. Maximum pre-fetch control block count (not supported)

This parameter specifies the maximum quantity of logical data blocks pre-fetched to the data buffer with the READ command or READ EXTENDED command. In the IDD the maximum pre-fetch quantity cannot be limited.

This parameter cannot be changed. The IDD disregards the specification in this field.

m. DRA (Disable Read-ahead) (not support)

This bit specifies whether or not activate the read-ahead operation.

This bit cannot be changed. The IDD disregards the specification in this bit.

"1" : Requests that the device server not read into the buffer any logical blocks beyond the addressed logical blocks.

"0" : The device server continues to read logical blocks into the buffer beyond the addressed logical blocks.

n. FSW (force sequential write) (not supported)

This bit specifies how to write multiple blocks.

"1" : If the IDD writes multiple blocks, this indicates that data are recorded on the disk media in the order in which they are transferred from the INIT.

"0" : If the IDD writes multiple blocks, this indicates that data are recorded on the disk media with their order changed in order to complete the command in the fastest time.

This bit cannot be changed. The IDD disregards the specification in this bit and operates according to the "Default" value (= "1").

o. LBCSS (Logical Block Cache Segment Size) (not supported)

"1" : Indicates that the "Cache segment size" field units are interpreted as logical blocks.

"0" : The "Cache segment size" field units are interpreted as bytes.

This bit is not supported for the IDD. The IDD disregards the specification in this bit.

p. Cache segment count

This parameter specifies the number of cache segments used by the IDD. This parameter is valid when the SIZE bit specification is "0."

When a value greater than max value is specified, the IDD performs rounding processing and sets max value. Also, when a value less than 3 is specified, the IDD performs rounding processing and set 4.

This parameter indicates the same value for all initiators and if it is changed by any initiator, a UNIT ATTENTION condition (UNIT ATTENTION [=6] / Mode select parameter changed [=2A-01]) is generated for all the initiators that did not change it.

This parameter can be changed though the IDD disregards the specification of this field. The IDD divides the Cache Segments according to the inherent algorithm. That is, the Cache Segment size is best tuned per the request data size of Host command. Within one Cache Segment, data for various commands are stored.

IDD does not support this parameter. IDD disregards the specification of this field.

q. Non cache buffer size

If this field is greater than zero, this field advises the device server how many bytes the application client requests that the device server allocate for a buffer function when all other cache segments are occupied by data to be retained. If the number is at least one, caching functions in the other

segments need not be impacted by cache misses to perform the SCSI buffer function. The impact of this field equals 0 or the sum of this field plus this field greater than the buffer size is vendor-specific.

This bit is not supported for the IDD. The IDD disregards the specification in this bit.

4.1.7 Control mode parameters (page code = 0A)

The page descriptor format of this MODE SELECT parameter is shown in Figure 4.8.

Byte \ Bit	7	6	5	4	3	2	1	0	
0	0	0	0	0	1	0	1	0	
1	X'0A' or X'06' (Page Length)								
2	TST			(Reserved)			GLTSD	RLEC	
	Default	0	0	0	0	0	0	0	
	Variable	0	0	0	0	0	1	1	
3	Queue Algorithm Qualifier				Reserved	Qerr		DQue	
	Default	0	0	0	0	0	0	0	
	Variable	1	1	1	1	0	1	1	
4	Reserved	RAC	Reserved		SWP	RAERP	UAAERP	EAERP	
	Default	0	0	0	0	0	0	0	
	Variable	0	0	0	0	0	0	0	
5	X'00' (Reserved)								
6-7	Ready Aer Holdoff Period								
	Default	X'0000'							
	Variable	X'0000'							
8-9	Busy Timeout Period								
	Default	X'0000'							
	Variable	X'0000'							
10-11	Extended Self-Test Completion Time								
	Default	X'xxxx'							
	Variable	X'0000'							

Figure 4.8 MODE SELECT parameters: control mode parameters

The parameters defined on this page control the operations of the tagged queuing function and statistical information function.

a. TST (Task Set Type)

This field specifies the type of task set defined below.

Value	Description
000b	Task set per logical unit for all initiators
001b	Task set per initiator per logical unit
010b-111b	Reserved

The IDD operates according to "000b". If other value is specified in this field, the IDD reports a "CHECK CONDITION" status (ILLEGAL REQUEST [=5] / Invalid parameter in list [=26-00]).

b. Queue algorithm qualifier

This parameter controls the execution order algorithm of a command issued together with a SIMPLE QUEUE TAG message.

When "0" is specified in this parameter, the IDD may change the queued command execution order in order to achieve the best performance.

The commands that may be reordered are:
Read, Read Extend, Write, Write Extend.

In case the commands whose specified LBAs are overlapped, the order of the commands in question are kept to ensure the Data Integrity.

When "1" is specified in this parameter, the IDD may change the queued command execution order in order to achieve the best performance.

The commands that may be reordered are:
Read, Read Extend, Write, Write Extend.

Despite the commands whose specified LBAs are overlapped, the IDD conducts reordering operation. Therefore the INIT who specifies "1" in this field shall ensure Data Integrity itself. The IDD disregards "1" in this field and operates as if "0" were specified.

When "F" is specified in this parameter, the IDD prohibits to order queued commands.

When other value is specified in this parameter, the IDD reports a CHECK CONDITION status (ILLEGAL REQUEST [=5] / Invalid parameter in List [=26-00]).

c. GLTSD (Global Logging Target Save Disable) (not supported)

This bit specifies whether or not to permit the saving treatment of peculiar logging parameter within the IDD.

Since the IDD performs the saving treatment with itself algorithm regardless of specified value in this bit, disregards the specification in this bit.

d. RLEC (Report Log Exception Condition) (not supported)

This bit controls operations in cases where the accumulated value log parameter reaches the maximum value.

"1" : The IDD reports a CHECK CONDITION status (UNIT ATTENTION [=6] / Log counter at maximum [5B-02]).

"0" : The IDD executes the command which is issued next normally.

Since the IDD does not support the reporting function of exception condition, the IDD disregards the specification in this bit.

e. DQue (disable queuing)

This bit specifies whether the IDD will execute processing of tagged commands or not.

"1" : The IDD prohibits tagged queuing processing. The IDD clears queued commands and generates a UNIT ATTENTION condition (Command cleared by another initiator [=2F-00]) for each of the INITs that issued the commands which were cleared. After that, when a QUEUE TAG message is received, it is rejected with a MESSAGE REJECT message and executed as an untagged command.

"0" : The IDD permits tagged queuing processing.

f. QErr (queue error management)

This field controls processing of commands queued after a sense hold state is canceled when the IDD is in the sense hold state.

Value	Description
00b	The IDD, when it has been in any one of various sense hold states, then that sense hold state is cleared, continues executing the commands which are queued by normal methods.
01b	The IDD, when it has been in any one of various sense hold states, then that sense hold state is cleared, clears the commands which are queued. At this time, the IDD generates a UNIT ATTENTION condition (UNIT ATTENTION [=6] / Command Cleared by Another Initiator [=2F-00]) for each of the INITs that issued the commands which were cleared.
10b	Reserved
11b	The IDD, when it has been in any one of various sense hold states, then that sense hold state is cleared, clears the commands which are queued by abnormal terminated INIT.

If "10b" is specified in this field, the IDD reports a CHECK CONDITION status (ILLEGAL REQUEST [=5] / Invalid parameter in list [=26-00]).

g. RAC (Report Check) (not supported)

The IDD is not supported in this bit. Therefore, the IDD always report "0", and ignore specified value.

h. SWP (Soft Write Protect) (not supported)

This bit specifies whether or not to execute for the device server write operation to the medium.

The IDD is not supported this bit. Therefore, the IDD always report "0", and ignore specified value.

i. RAERP, UAAERP, EAERP, READY AER HOLDOFF PERIOD (not supported)

These field specify the action method of asynchronous event reporting protocol.

The IDD is not supported these field. Therefore, the IDD always report '0', and ignore specified value.

j. Extended Self-Test Completion Time

This field contains advisory data that an application client may use to determine the time in seconds that the device server requires to complete an extended self-test when the device server is not interrupted by subsequent commands and no errors occur during execution of the self-test.

This field only use to report the value by the MODE SENSE / MODE SENSE EXTENDED command.

Therefore, the IDD ignores specified value by the MODE SELECT / MODE SELECT EXTENDED command.

4.1.8 Notch parameter (page code = 0C)

Byte \ Bit	7	6	5	4	3	2	1	0
0	0	0	0	0	1	1	0	0
1	X'16' (Page Length)							
2	ND	LPN	X'00' (Reserved)					
Default	0	0	0	0	0	0	0	0
Variable	0	1	0	0	0	0	0	0
3	X'00' (Reserved)							
4-5	Maximum number of notches							
Default	X'00xx'							
Variable	X'0000'							
6-7	Active Notch							
Default	X'0000'							
Variable	X'FFFF'							
8-11	Starting Boundary							
Default	X'00000000'							
Variable	X'00000000'							
12-15	Ending Boundary							
Default	X'xxxxxxxx'							
Variable	X'00000000'							
16-23	Page Notch							
Default	X'000000000000000008'							
Variable	X'0000000000000000'							

Figure 4.9 MODE SELECT parameters: notch parameter

This page is used to report the top address and final address of each zone.

If the zone number + 1 of the notching zone is set in the "Active notch" field and this parameter is issued, the starting and ending address of the specified zone can be referred to by the MODE SENSE command.

Also, if Page 3 and Page 3F are specified by the MODE SENSE command, the parameters below the zone specified in the notch page can be referred to.

- Track/zone (Page 3, Byte 02, 03) (Note)
- Sector count/track (Page 3, Bytes 10, 11)
- Track Skew Factor (Page 3, Bytes 16, 17)
- Cylinder Skew Factor (Page 3, Bytes 18, 19)

Note:

Normally, the number of tracks (logical heads) per cell is set in the track count/zone, but in the case of notching only, the total track count (number of cylinders in the zone x number of logical heads) of the affected zone is reported.

If this parameter is issued, only the format parameter of the zone specified by the MODE SENSE command can be referred to without changing the number of accessible blocks.

Also, if a MODE SENSE command with a SP = "1" that includes a notch page is issued, the current value is reported for this page and the zone value which is the object is reported if Page 3 is notched, then the command is terminated normally. However, in the case of the FORMAT CORRUPTED state, caution is necessary because the value following changing of the Format parameter is reported.

The contents of each parameter are explained below.

- ND (Notch Drive)

"0" : Since the device is not in the notched state, "0" is reported for LPN, active notch, starting boundary and ending boundary.

"1" : Since the device is in the notched state, the starting boundary and ending boundary for the zone number (+1) shown in the active notch is set in the format specified in the LPN Bit.

- LPN (Logical or Physical Notch)

"0" : This shows that the boundary address is based on the physical address format. At that time, the higher order 3 bytes show the logical cylinder number and the lowest order byte shows the logical head number.

"1" : This shows that the boundary address is based on the 4-byte logical block address format.

This bit is a bit which must be set during MODE SELECT.

- Maximum Number of Notches

This indicates the number of device zones. 18 (X'12') zones are set for all drives.

- Active Notch

This specifies the zone number 1 to 18 of a notching zone. If "0" is specified, the page and parameter changed by the notch page, and the notch page itself, are changed to the initial value. If a value which exceeds the maximum number of notches has been specified, the test ends by "CHECK CONDITION" status (ILLEGAL REQUEST [=5]/Invalid parameter in List [=26-00]).

This field is a field which must be set during MODE SELECT.

- Starting Boundary

This field is enabled by the MODE SENSE command. This field indicates the beginning of the active notch or, if the active notch is zero, the beginning of the logical unit (IDD).

- Ending Boundary

This field is valid in the MODE SENSE command. This field indicates the ending of the active notch or, if the active notch is zero, the ending of the logical unit (IDD).

- Page Notch

This is a bit map which shows whether or not other mode pages are being changed if the device is notched. The most significant bit of this field corresponds to page code 3Fh and the least significant bit corresponds to page code 00h. If it is specified, the IDD disregards this value.

4.1.9 Port control parameter (page code = 19)

This page is used to set parameters related to drive transfer and to refer to the currently set values and maximum values.

[Page_0 Format (Short Page Format)]

		Bit							
		7	6	5	4	3	2	1	0
Byte	0	0	SPF (0)	0	1	1	0	0	1
	1	X '06' (Page Length)							
	2	Reserved				Protocol Identifier			
	Default	0	0	0	0	0	0	0	1
	Variable	0	0	0	0	0	0	0	0
	3	X '00' (Reserved)							
	4-5	Synchronous Transfer Timeout							
	Default	X '0000'							
	Variable	X 'FFFF'							
	6-7	X '00' (Reserved)							

Figure 4.10 MODE SELECT parameters: port control parameter

a. SPF

“0”: This shows that transfer data is based on the Short Page Format.

“1”: This shows that transfer data is based on the Long Page Format.

b. Protocol Identifier

1h: This shows that this page conforms to the SPI SCSI Device.

c. Synchronous Transfer Timeout

This specifies time monitoring starting and ending with the following events (time is specified in units of ms):

- 1) The timer (count) is initialized and started when a new REQ is sent in a state in which the entire ACK response to an already sent REQ of the device has been completed.
- 2) The timer operation is not affected even when a new REQ is sent in a state in which the ACK response to an already sent REQ of the device is not completed.
- 3) The timer is initialized and started when the device detects an ACK response while the ACK response to an already sent REQ has not been completed.
- 4) The timer is stopped when the device detects an ACK response after the ACK response to an already sent REQ has been completed.

Value specified in Synchronous Transfer Timeout field	Time or exception operation
0x0000	Prohibited
0x0001-0xFFFE	Specified time (msec)
0xFFFF	Not limited

[Sub_Page Format (Long Page Format)]

		Bit							
		7	6	5	4	3	2	1	0
Byte	0	0	SPF (1)	0	1	1	0	0	1
	1	Subpage Code							
	2-3	Subpage Length							
	4	X '00' (Reserved)							
	5	Reserved				Protocol Identifier			
	Default	0	0	0	0	0	0	0	1
	Variable	0	0	0	0	0	0	0	0
	6-n	Protocol Specific Mode Parameters							

a. Subpage Code

This shows the page code of a subpage used during Long Page Format specification.

Subpage Code	Parameter	Support state
00h	Not allowed	-----
01h	Margin control subpage	Supported
02h	Saved training configuration value subpage	Supported
03h	Negotiated setting subpage	Supported
04h	Report transfer capabilities subpage	Supported
05h-DFh	Reserved	-----
E0h-FEh	Vendor specific	-----
FFh	Return all subpages for the port control Page	Supported

Note:

For the most recent information, see SPI-4 of the ANSI standard.

If X'00' is specified for the subpage code or if an unsupported page is specified by the Mode Select command, the command terminates with the CHECK CONDITION status (ILLEGAL REQUEST [=5] / Invalid Field in Parameter List [=26/00]), and all parameters specified by this command are invalidated.

b. Subpage Length

This field specifies the length (in bytes) of the parameter field beginning from byte 4, excluding the page header portion. The value is unique for each subpage code. The INIT must specify the same page length as that reported from the IDD through the Mode Sense or Mode Sense Extended command. If an invalid page length is specified, the Mode Select command terminates with the CHECK CONDITION status (ILLEGAL REQUEST [=5] / Invalid Field in Parameter List [=26/00]), and all parameters specified by this command are invalidated.

c. Protocol Specific Mode Parameters

The subpage itself enters this area.

(SubPage 01: Margin Control)

		Bit							
		7	6	5	4	3	2	1	0
Byte	0	X '00' (Reserved)							
	1	Driver Strength				Reserved			
	Default	0	0	0	0	0	0	0	0
	Variable	1	1	1	1	0	0	0	0
	2	Driver Asymmetry				Driver Precompensation			
	Default	0	0	0	0	0	0	0	0
	Variable	0	0	0	0	0	0	0	0
	3	Driver Slew Rate				Reserved			
	Default	0	0	0	0	0	0	0	0
	Variable	1	1	1	1	0	0	0	0
	4-6	X '00' (Reserved)							
	7	Vendor Specific							
	Default	0	0	0	0	0	0	0	0
	Variable	0	0	0	0	0	0	0	0
	8-15	X '00' (Reserved)							

This subpage is used to set and report margin adjustment values between the SCSI initiator and target port during synchronization and Paced transfers.

The Mode Sense command reports the currently set values, and it reports zero for unsupported parameters.

a. Driver Strength

This shows the amount of current of the driver source.

b. Driver Precompensation (not supported)

This shows the amplitude difference between strong and weak drivers when Driver Precompensation is valid.

c. Driver Asymmetry (not supported)

This shows the amplitude difference between the assert and negate signals sent from the driver.

d. Driver Slew Rate

This shows the result obtained by dividing the size difference between assertion and negation by the time difference between rising and falling.

The default values of the above parameters a to d are X'0000'.

A value in this field is indicated by an absolute value (2's complement) that does not affect the preset value based on the default value. As listed below, the value is specified in 16 stages, from B'0111' (maximum value) to B'1000' (minimum value). If a specified value cannot be supported according to the capability of a device, the value is rounded off.

		Remark
Bin (b)	Dec (d)	
0111	7	Maximum setting
0110	6	
0101	5	
0100	4	
0011	3	
0010	2	
0001	1	
0000	0	
1111	-1	Minimum setting
1110	-2	
1101	-3	
1100	-4	
1011	-5	
1010	-6	
1001	-7	
1000	-8	

The operation corresponding to each value depends on the vendor, so the ANSI standard does not define the difference between actual maximum and minimum values. However, the setting does not violate the applicable standard.

Only the REQUEST, ACKNOWLEDGE, DATA BUS, P_CRCA, and DB (P1) signals are affected to the same degree by this setting.

(SubPage 02: Saved Training Configuration)

		Bit							
		7	6	5	4	3	2	1	0
Byte	0-3	X '00' (Reserved)							
	4-7	DB (0) Value							
	64-67	DB (15)Value							
	68-71	P_CRCA Value							
	72-75	P1 Value							
	76-79	BSY Value							
	80-83	SEL Value							
	84-87	RST Value							
	88-91	REQ Value							
	92-95	ACK Value							
	96-99	ATN Value							
	100-103	C/D Value							
	104-107	I/O Value							
	108-111	MSG Value							
	112-227	X '00' (Reserved)							

(SubPage 03: Negotiated Setting)

		Bit							
		7	6	5	4	3	2	1	0
Byte	0	Transfer Period Factor							
	Default	x	x	x	x	x	x	x	x
	Variable	0	0	0	0	0	0	0	0
	1	X'00'(Reserved)							
	2	REQ/ACK Offset							
	Default	x	x	x	x	x	x	x	x
	Variable	0	0	0	0	0	0	0	0
	3	Transfer Width Exponent							
	Default	x	x	x	x	x	x	x	X
	Variable	0	0	0	0	0	0	0	0
	4	Rsv	Protocol Option Bits						
	Default	0	x	x	x	x	x	x	X
	Variable	0	0	0	0	0	0	0	0
	5	Reserved				Transceiver Mode		SENT PCOMP_EN	RCVD PCOMP_EN
	Default	0	0	0	0	x	x	x	x
	Variable	0	0	0	0	0	0	0	0
	6-7	X'00'(Reserved)							

This subpage is used to report the negotiation settings of the SCSI target port of the current I_T NEXAS.

a. Transfer Period Factor

This field indicates the transfer rate value for a transfer established by the current I_T NEXAS.

Note:

When an asynchronous transfer is established (REQ/ACK Offset is set to X'00'), the value reported by this parameter is not in effect and has no meaning.

Period value	Parameter
08h	160 MHz
09h	80 MHz
0Ah	40 MHz
0Bh	30.3MHz
0Ch	20 MHz
0Dh - 18h	19.2 to 10.4MHz (*)
19h - 31h	10.0 to 5.1MHz (*)
32h	5 MHz

*1 The transfer cycle is calculated as (Period value * 4)(ns).

b. REQ/ACK Offset

This field indicates the REQ/ACK offset for a transfer established by the current I_T NEXAS.

Value	Parameter
00h	Asynchronous transfer
01h - FEh	Synchronous transfer or Paced transfer according to the offset as established by Negotiation
FFh	Synchronous transfer or Paced transfer according to an unlimited offset

c. Transfer Width Exponent

This field indicates the data transfer width of a transfer established by the current I_T NEXAS.

Value	Parameter
00h	8-bit data bus
01h	16-bit data bus
02h	Obsolete
03h - FFh	Reserved

d. Protocol Option Bits

This field indicates the protocol options established by the current I_T NEXAS.

Bit	Bit name	Parameter
7	PCOMP_EN (*1)	Precompensation enable
6	RTI	Retain training information
5	RD_STRM	Read streaming and read flow control enable
4	WR_FLOW	Write flow control enable
3	HOLD_MCS	Hold margin control setting
2	QAS_REQ	QAS enable request
1	DT_REQ	DT clocking enable request
0	IU_REQ	Information units enable request

*1 The PCOM_EN bit is reserved on this subpage and is used on subpage 4.

e. Received (RCVD) PCOMP_EN

This bit indicates the PCOMP_EN bit received by the SCSI target port of the current I_T NEXAS.

f. Sent PCOMP_EN

This bit indicates the PCOMP_EN bit sent from the SCSI target port of the current I_T NEXAS.

g. Transceiver Mode

This field indicates as follows the current bus mode of the SCSI target port.

Value	Parameter
00b	Unclear (device that can report no bus mode, etc.)
01b	Single ended
10b	Low Voltage Differential
11b	High Voltage Differential

(SubPage 04: REPORT Transfer Capability)

		Bit							
		7	6	5	4	3	2	1	0
Byte	0	Minimum Transfer Period Factor							
	Default	0	0	0	0	1	0	0	0
	Variable	0	0	0	0	0	0	0	0
	1	X '00' (Reserved)							
	2	Maximum REQ/ACK Offset							
	Default	0	1	1	1	1	1	1	1
	Variable	0	0	0	0	0	0	0	0
	3	Maximum Transfer Width Exponent							
	Default	0	0	0	0	0	0	0	1
	Variable	0	0	0	0	0	0	0	0
	4	Protocol Option Bits Supported							
	Default	1	1	1	1	1	1	1	1
	Variable	0	0	0	0	0	0	0	0
	5-7	X '00' (Reserved)							

This subpage is used to report the transfer capability of the SCSI target port. Individual parameters cannot be changed by the Mode Select command. For the following parameter values, see the description of subpage 3:

- 1) Minimum Transfer Period Factor
This shows the minimum transfer rate value supported by the SCSI target port.
- 2) Maximum REQ/ACK Offset
This shows the maximum REQ/ACK offset supported by the SCSI target port.
- 3) Maximum Transfer Width Exponent
This shows the maximum data transfer width supported by the SCSI target port.
- 4) Protocol Option Bits Supported
This shows the protocol options supported by the SCSI target port.

4.1.10 Informational exceptions control page (page code = 1C)

The page descriptor format of this MODE SELECT parameter is shown in Figure 4.9.

Byte \ Bit	7	6	5	4	3	2	1	0
0	0	0	0	1	1	1	0	0
1	Page length (X'0A')							
2	Perf	0	EBF	EWASC	DExcpt	Test	0	LogErr
Default	0	0	0	0	1	0	0	0
Variable	1	0	1	1	1	1	0	1
3	0	0	0	0	MRIE			
Default	0	0	0	0	0	0	0	0
Variable	0	0	0	0	0	1	1	1
4-7	Interval Timer							
Default	X'00000000'							
Variable	X'FFFFFFFF'							
8-11	Report Count							
Default	X'00000001'							
Variable	X'FFFFFFFF'							

Figure 4.11 MODE SELECT parameters: informational exception control

This page specifies whether the drive failure prediction function is enabled or disabled and the reporting method when a drive failure is predicted.

The log errors bit (**LogErr**) of zero indicates that the logging of informational exception conditions within a target is vendor specific. A LogErr bit of one indicates the target logs informational exception conditions.

A **Test** bit of one creates a false device failure at the next interval time, if the DExcpt bit is not set. When the Test bit is one, the MRIE and Report count fields apply as if the Test bit were zero. The false device failure is reported with an additional sense code of FAILURE PREDICTION THRESHOLD EXCEEDED [=50-FF]. If both the Test and the DExcpt bits are one, the device server terminate the MODE SELECT command with CHECK CONDITION status. The sense key is set to ILLEGAL REQUEST [=5] with the additional sense code set to INVALID FIELD IN PARAMETER LIST [=26-00]. A Test bit of zero instructs the device server not to generate any false device failure notifications.

A disable exception control (DExcpt) bit of zero indicates information exception operations is enabled. The reporting of information exception conditions when the "DExcpt" bit is set to zero is determined from the method of reporting informational exceptions field. A "DExcpt" bit of one indicates the target disables all information exception operations. The method of reporting informational exceptions field is ignored when "DExcpt" is set to one.

An enable warning (EWASC) bit of zero indicates the target disables reporting of the warning. The "MRIE" field is ignored when "DExcpt" is set to one and "EWASC" is set to zero. An "EWASC" bit of one indicates warning reporting is enabled. The method for reporting the warning when the "EWASC" bit is set to one is determined from the "MRIE" field.

If background functions are supported, an Enable Background Function (EBF) bit of one indicates the target enables background functions. An "EBF" bit of zero indicates the target disables the functions.

The IDD disregards the specified value and operates according to the "Default" value ("0").

A Performance (**Perf**) bit of zero indicates that informational exception operations that are the cause of delays are acceptable. A Perf bit of one indicates the target is not cause delays while doing informational exception operations. A Perf bit set to one may cause the target to disable some or all of the informational exceptions operations, thereby limiting the reporting of informational exception conditions.

The Method of Reporting Informational Exceptions (**MRIE**) field indicates the methods that is used by the target to report informational exception conditions. The priority of reporting multiple informational exceptions is vendor specific.

Table 4.2 MRIE (Methods of reporting informational exception conditions)

MRIE	Descriptor
X'00'	<p>No reporting of informational exception conditions: This method instructs the target to not report informational exception conditions.</p>
X'01' (setting prohibited)	<p>Asynchronous event reporting: This method instructs the target to report informational exception conditions by using the rules for asynchronous event reporting as described in the SCSI-3 Architecture Model and the relevant Protocol Standard. The sense key shall be set to RECOVERED ERROR and the additional sense code shall indicate the cause of the informational exception condition.</p>
X'02'	<p>Generate unit attention: This method instructs the target to report informational exception conditions by returning a CHECK CONDITION status on any command. The sense key shall be set to UNIT ATTENTION and the additional sense code shall indicate the cause of the informational exception condition. The command that has the CHECK CONDITION shall not be executed before the informational exception condition is reported.</p>
X'03'	<p>Conditionally generate recovered error: This method instructs the target to report informational exception conditions, dependent on the value of the per bit of the error recovery parameters mode page, by returning a CHECK CONDITION status on any command. The sense key shall be set to RECOVERED ERROR and the additional sense code shall indicate the cause of the informational exception condition. The command that has the CHECK CONDITION shall complete without error before any informational exception condition may be reported.</p>
X'04'	<p>Unconditionally generate recovered error: This method instructs the target to report informational exception conditions, regardless of the value of the per bit of the error recovery parameters mode page, by returning a CHECK CONDITION status on any command.. The sense key shall be set to RECOVERED ERROR and the additional sense code shall indicate the cause of the informational exception condition. The command that has the CHECK CONDITION shall complete without error before any informational exception condition may be reported.</p>
X'05' (setting prohibited)	<p>Generate no sense: This method instructs the target to report informational exception conditions by returning a CHECK CONDITION status on any command. The sense key shall be set to NO SENSE and the additional sense code shall indicate the cause of the informational exception condition. The command that has the CHECK CONDITION shall complete without error before any informational exception condition may be reported.</p>
X'06'	<p>Only report informational exception condition on request: This method instructs the target to report informational exception(s) information. To find out about information exception conditions the Application Client polls the target by issuing an unsolicited REQUEST SENSE command. The sense key shall be set to NO SENSE and the additional sense code shall indicate the cause of the information exception condition.</p>
X'07'- X'0B'	Reserved
X'0C'- X'0F'	Reserved (Vendor Specific)

The "Interval Timer" field indicates the period in 100 millisecond increments for reporting that an informational exception condition has occurred. The target does not report informational exception conditions more frequently than the time specified by the "Interval Timer" field and as soon as possible after the timer interval has elapsed. After the informational exception condition has been reported the interval timer is restarted. A value of zero in the "Interval Timer" field indicates that the target shall only report the informational exception condition one time. A value of X'FFFFFFFF' in the "Interval Timer" field indicates the timer interval is vendor specific.

In the implementation, actual period unit to be used in reporting information exception condition is minute. Therefore a value is rounded-up to minute as shown below. A value of zero and X'FFFFFFFF' in the interval timer field indicates that drive report the information exception condition once.

A value of TIMER INTERVAL field	Actual time interval (minutes)
0, 0xFFFFFFFFh	Drive reports the informational exception condition once
1-600	1
601-1200	2
1201-1800	3
0xFFFFFE11-0xFFFFFFE	7158279

The "**Report Count**" field indicates the number of timer to report an informational exception conditions to the application client. A value of zero in the Report Count field indicates there is no limit on the number of timers the target shall report an information exception condition.

4.1.11 Background control mode parameter (page code = 1C/subpage = 01)

Note:

This parameter is not supported. When this parameter is set during MODE SELECT, this command is terminated with error. (ILLEGAL REQUEST [=5] / Invalid Field in Parameter List [=26/00]) In MODE SENSE, this parameter is not transferred.

Byte \ Bit	7	6	5	4	3	2	1	0
0	1	1	0	1	1	1	0	0
1	Subpage Code = 01							
2-3	Subpage Length							
4	Reserved							EN_BMS
Default	0	0	0	0	0	0	0	0
Variable	0	0	0	0	0	0	0	1
5	Reserved							EN_PS
Default	0	0	0	0	0	0	0	0
Variable	0	0	0	0	0	0	0	1
6-7	BMS Interval Time							
Default	X '00AB'							
Variable	X 'FFFF'							
8-9	PRE-SCAN Timeout Value							
Default	X '0000'							
Variable	X 'FFFF'							
10-15	X '00' (Reserved)							

a. EN_BMS (Enable Background Media Scan)

"1": a background medium scan operations are enabled.

"0": a background medium scan is disabled.

Background medium scanning means the operation is performed without using any bandwidth on the SCSI interface.

b. EN_PS (Enable Pre-Scan)

"1": a background medium scan operation shall not start until after the pre-scan operation is halted or completed.

The BMS interval time shall occur before a background medium scan operation is started.

"0": Pre-Scan is disabled.

The background pre-scan feature is enabled by setting the EN_PS bit in the Background Control mode page, then setting the EN_PS bit and power cycling the device. After power is restored the pre-scan timer is set and the device begins scanning the medium starting at LBA zero and ending with the last LBA.

After one pre-scan processing, IDD do not execute the next pre-scan processing until the following sequence.

1. EN_PS bit set to '0'
2. EN_PS bit set to '1'
3. Power Off and On

c. BMS Interval Time

This parameter specifies the minimum time, in hours, between the end of one pre-scan or background medium scan operation and the start of the next background medium scan operation.

d. Pre-Scan Timeout Value

This parameter specifies the maximum time, in hours, for a pre-scan operation to complete. If the pre-scan operation does not complete within the specified time then it is halted. A value of zero specifies an unlimited timeout value.

4.1.12 Additional error recovery parameters (page code = 21)

The page descriptor format of this MODE SELECT parameter is shown in Figure 4.10

		[Fujitsu unique parameter]							
Byte \ Bit	Bit	7	6	5	4	3	2	1	0
0		0	0	1	0	0	0	0	1
1		X'02' (Page Length)							
2		0	0	0	0	Number of retries during a Seek Error			
	Default	0	0	0	0	1	1	1	1
	Variable	0	0	0	0	1	1	1	1
3		RFJ							
	Default	0	0	0	0	0	0	0	0
	Variable	0	0	0	0	0	0	0	0

Figure 4.12 MODE SELECT parameters: additional error recovery parameters

a. Number of retries during a seek error

This parameter specifies the number of times repositioning is retried when a seek error is detected. When zero is specified in this field, repositioning retries are prohibited. The value specified in this field is applicable for all commands which are accompanied by a seek operation.

b. RFJ (reserved by Fujitsu)

All the bits in byte 3 are reserved by Fujitsu. The user should specify "0" in this bit.

4.2 Log Parameters

This clause describes the log page structure and the log pages that are applicable to all SCSI devices. Pages specific to each device type are described in the command standard that applies to that device type. The LOG SENSE command returns a single log page specified in the page code field of the command descriptor block.

4.2.1 Supprot log page (X'00')

The supported log page returns the list of log pages implemented by the drive.

Byte \ Bit	7	6	5	4	3	2	1	0
0	0	0	0	1	0	1	0	1
1	0	0	0	0	0	0	0	0
2	X'00' (Parameter Length)							
3	X'0D' (Parameter Length)							
4	X'00' (Supported Page)							
5	X'01' (Supported Page)							
6	X'02' (Supported Page)							
7	X'03' (Supported Page)							
8	X'05' (Supported Page)							
9	X'06' (Supported Page)							
10	X'0D' (Supported Page)							
11	X'0E' (Supported Page)							
12	X'0F' (Supported Page)							
13	X'10' (Supported Page)							
14	X'2F' (Supported Page)							
15	X'38' (Supported Page)							

4.2.2 Buffer overrun / underrun page (X'01')

Byte \ Bit	7	6	5	4	3	2	1	0
0	0	0	0	0	0	0	0	1
1	X'00' (Reserved)							
2	X'00' (Page Length)							
3	X'0C' (Page Length)							
4	X'00' (Reserved)							
5	Count Basis			Cause				Type
	0	0	0	0	0	0	0	0
6	DU	DS	TSD	ETC	TMC		LBIN	LP
	0	0	0	0	0	0	0	0
7	X'02' (Parameter Length)							
8-9	X'0000' (Data Underrun)							
10	X'00' (Reserved)							
11	Count Basis			Cause				Type
	0	0	0	0	0	0	0	0
12	DU	DS	TSD	ETC	TMC		LBIN	LP
	0	0	0	0	0	0	0	0
13	X'02' (Parameter Length)							
14-15	X'0000' (Data Overrun)							

Cause

- 0h : Undefined
- 1h : SCSI bus busy, optional
- 2h : Transfer rate too slow, optional
- 3h-Fh : Reserved

The drive does not support this field. Zero is always reported.

- Count Basis
 - 0h : Undefined
 - 1h : Per command, optional
 - 2h : Per failed reconnect, optional
 - 3h : Per unit of time, optional
 - 4h-7h : Reserved

The drive does not support this field. Zero is always reported.

- **Data Underrun**
Count of data underruns which occur during write operation when a buffer empty condition prevents continued transfer of data to the media from the buffer.

The drive does not support this field due to a hardware limitation. Zero is always reported.

- **Data Overrun**
Count of data overruns which occur during read operation when a buffer full condition prevents continued transfer of data from the media to the buffer.

The drive does not support this field due to a hardware limitation. Zero is always reported.

4.2.3 Write error count page (X'02')

Byte \ Bit	7	6	5	4	3	2	1	0
0	0	0	0	0	0	0	1	0
1	X'00' (Reserved)							
2	Page Length (MSB)							
3	Page Length (LSB)							

All of the following parameters have this header.

Page Length will be defined based on the value of Parameter Pointer. (CDB 5-6)

4.2.3.1 Write errors recovered without delays (Page 02, Code 0000)

Byte \ Bit	7	6	5	4	3	2	1	0
4	(MSB) X'0000' (Parameter code) (Errors Recovered Without Delays) (LSB)							
5								
6	DU	DS	TSD	ETC	TMC		LBIN	LP
	0	0	0	0	0	0	0	0
7	X'04' (Parameter Length)							
8	(MSB) Counter Value (LSB)							
9								
10								
11								
11								

The Counter Value indicates the count of all recovered write errors that would not be reported to the initiator during write operations, because no delay is incurred.

The drive does not support this field due to a hardware limitation. Zero is always reported.

4.2.3.2 Write errors recovered with possible delays (Page 02, Code 0001)

Byte \ Bit	7	6	5	4	3	2	1	0
4	(MSB) X'0001' (Parameter code) (Errors Recovered With Possible Delays) (LSB)							
5								
6	DU	DS	TSD	ETC	TMC		LBIN	LP
	0	0	0	0	0	0	0	0
7	X'04' (Parameter Length)							
8	(MSB) Counter Value (LSB)							
9								
10								
11								

The Counter Value indicates the count of all recovered write errors that would not be reported to the initiator during write operations, because possible delay is incurred.

4.2.3.3 Total posted write errors (Page 02, Code 0002)

Byte \ Bit	7	6	5	4	3	2	1	0
4	(MSB) X'0002' (Parameter code) (Total Posted Errors) (LSB)							
5								
6	DU	DS	TSD	ETC	TMC		LBIN	LP
	0	0	0	0	0	0	0	0
7	X'04' (Parameter Length)							
8	(MSB) Counter Value (LSB)							
9								
10								
11								

The Counter Value indicates the count of all posted errors to the interface during write operations.

Implementation:

If a write error is posted, it will force a save of all error log pages information.

4.2.3.4 Total posted recoverable write errors (Page 02, Code 0003)

Byte \ Bit	7	6	5	4	3	2	1	0
4	(MSB) X'0003' (Parameter code) (Total Posted Recoverable Errors) (LSB)							
5								
6	DU	DS	TSD	ETC	TMC		LBIN	LP
	0	0	0	0	0	0	0	0
7	X'04' (Parameter Length)							
8	(MSB) Counter Value (LSB)							
9								
10								
11								

The Counter Value indicates the count of all posted recovered (01/xx/xx) errors to the interface during write operations.

4.2.3.5 Total write bytes processed (Page 02, Code 0005)

Byte \ Bit	7	6	5	4	3	2	1	0
4	(MSB) X'0005' (Parameter code) (Total Bytes Processed) (LSB)							
5								
6	DU	DS	TSD	ETC	TMC		LBIN	LP
	0	0	0	0	0	0	0	0
7	X'0A' (Parameter Length)							
8	(MSB) Total Write Bytes Processed (10 bytes) (LSB)							
9								
~								
~								
~								
16	(LSB)							
17								

The Total Write Bytes Processed indicates the total processed bytes during write operations.

4.2.3.6 Total posted unrecoverable write errors (Page 02, Code 0006)

Byte \ Bit	7	6	5	4	3	2	1	0
4	(MSB) X'0006' (Parameter code) (Total Posted Unrecoverable Errors) (LSB)							
5								
6	DU	DS	TSD	ETC	TMC		LBIN	LP
	0	0	0	0	0	0	0	0
7	X'04' (Parameter Length)							
8	(MSB) Counter Value (LSB)							
9								
10								
11								

The Counter Value indicates the count of all posted unrecovered errors (03/xx/xx) to the interface during write operations.

4.2.4 Read error count page (X'03')

Byte \ Bit	7	6	5	4	3	2	1	0
0	0	0	0	0	0	0	1	1
1	X'00' (Reserved)							
2	Page Length (MSB)							
3	Page Length (LSB)							

All of the following parameters have this header.

Page Length will be defined based on the value of Parameter Pointer. (CDB 5-6)

4.2.4.1 Read errors recovered without delays (Page 03, Code 0000)

Byte \ Bit	7	6	5	4	3	2	1	0
4	(MSB) X'0000' (Parameter code) (Errors Recovered Without Delays) (LSB)							
5								
6	DU	DS	TSD	ETC	TMC		LBIN	LP
	0	0	0	0	0	0	0	0
7	X'04' (Parameter Length)							
8	(MSB) Counter Value (LSB)							
9								
10								
11								

The Counter Value indicates the count of all recovered read errors.

Because the IDD does not support this parameter, 0 is always reported.

4.2.4.2 Read errors recovered with possible delays (Page 03, Code 0001)

Byte \ Bit	7	6	5	4	3	2	1	0
4	(MSB) X'0001' (Parameter code) (Errors Recovered With Possible Delays) (LSB)							
5								
6	DU	DS	TSD	ETC	TMC		LBIN	LP
	0	0	0	0	0	0	0	0
7	X'04' (Parameter Length)							
8	(MSB) Counter Value (LSB)							
9								
10								
11								

The Counter Value indicates the count of all recovered read errors that would not be reported to the initiator during read operations, because possible delay is incurred.

4.2.4.3 Total posted read errors (Page 03, Code 0002)

Byte \ Bit	7	6	5	4	3	2	1	0
4	(MSB) X'0002' (Parameter code) (Total Posted Errors) (LSB)							
5								
6	DU	DS	TSD	ETC	TMC		LBIN	LP
	0	0	0	0	0	0	0	0
7	X'04' (Parameter Length)							
8	(MSB) Counter Value (LSB)							
9								
10								
11								

The Counter Value indicates the count of all posted errors to the interface during read operations. The value includes the count of all posted verify errors to the interface (page X'05', Parameter code X'0002').

Implementation:

If a read error is posted, it will force a save of all error log pages information.

4.2.4.4 Total posted recoverable read errors (Page 03, Code 0003)

Byte \ Bit	7	6	5	4	3	2	1	0
4	(MSB) X'0003' (Parameter code) (Total Posted Recoverable Errors) (LSB)							
5								
6	DU	DS	TSD	ETC	TMC		LBIN	LP
	0	0	0	0	0	0	0	0
7	X'04' (Parameter Length)							
8	(MSB) Counter Value (LSB)							
9								
10								
11								

The Counter Value indicates the count of all posted recovered (01/xx/xx) errors to the interface during read operations. The value includes the count of all posted recovered verify errors (page X'05', Parameter code X'0003').

4.2.4.5 Total read bytes processed (Page 03, Code 0005)

Byte \ Bit	7	6	5	4	3	2	1	0
4	(MSB) X'0005' (Parameter code) (Total Bytes Processed) (LSB)							
5								
6	DU	DS	TSD	ETC	TMC		LBIN	LP
	0	0	0	0	0	0	0	0
7	X'0A' (Parameter Length)							
8	(MSB) Total Read Bytes Processed (10 bytes) (LSB)							
9								
~								
~								
~								
16								
17								

The Total Read Bytes Processed indicates the total processed bytes during read operation.

The bytes includes the total processed bytes during verify operation. (page X'05', Parameter code X'0005')

4.2.4.6 Total posted unrecoverable read errors (Page 03, Code 0006)

Byte \ Bit	7	6	5	4	3	2	1	0
4	(MSB) X'0006' (Parameter code) (Total Posted Unrecoverable Errors) (LSB)							
5								
6	DU	DS	TSD	ETC	TMC		LBIN	LP
	0	0	0	0	0	0	0	0
7	X'04' (Parameter Length)							
8	(MSB) Counter Value (LSB)							
9								
10								
11								
~								

The Counter Value indicates the count of all posted unrecovered errors (03/xx/xx) to the interface during read operations. The value includes the count of all posted unrecovered verify errors (page X'05', Parameter code X'0006').

4.2.5 Verify error count page (X'05')

Byte \ Bit	7	6	5	4	3	2	1	0
0	0	0	0	0	0	1	0	1
1	X'00' (Reserved)							
2	Page Length (MSB)							
3	Page Length (LSB)							

All of the following parameters have this header.

Page Length will be defined based on the value of Parameter Pointer. (CDB 5-6)

4.2.5.1 Verify errors recovered without delays (Page 05, Code 0000)

Byte \ Bit	7	6	5	4	3	2	1	0
4	(MSB) X'0000' (Parameter code) (Errors Recovered Without Delays) (LSB)							
5								
6	DU	DS	TSD	ETC	TMC		LBIN	LP
	0	0	0	0	0	0	0	0
7	X'04' (Parameter Length)							
8	(MSB) Counter Value (LSB)							
9								
10								
11								

The Counter Value indicates the count of all recovered verify errors that would not be reported to the initiator during verify operations, because no delay is incurred.

4.2.5.2 Verify errors recovered with possible delays (Page 05, Code 0001)

Byte \ Bit	7	6	5	4	3	2	1	0
4	(MSB) X'0001' (Parameter code) (Errors Recovered With Possible Delays) (LSB)							
5								
6	DU	DS	TSD	ETC	TMC		LBIN	LP
	0	0	0	0	0	0	0	0
7	X'04' (Parameter Length)							
8	(MSB) Counter Value (LSB)							
9								
10								
11								

The Counter Value indicates the count of all recovered verify errors that would not be reported to the initiator during verify operations, because possible delay is incurred.

4.2.5.3 Total posted verify errors (Page 05, Code 0002)

Byte \ Bit	7	6	5	4	3	2	1	0
4	(MSB) X'0002' (Parameter code) (Total Posted Errors) (LSB)							
5								
6	DU	DS	TSD	ETC	TMC		LBIN	LP
	0	0	0	0	0	0	0	0
7	X'04' (Parameter Length)							
8	(MSB) Counter Value (LSB)							
9								
10								
11								

The Counter Value indicates the count of all posted errors to the interface during verify operations.

Implementation:

If a verify error is posted, it will force a save of all error log page information.

4.2.5.4 Total posted recoverable verify errors (Page 05, Code 0003)

Byte \ Bit	7	6	5	4	3	2	1	0
4	(MSB) X'0003' (Parameter code) (Total Posted Recoverable Errors) (LSB)							
5								
6	DU	DS	TSD	ETC	TMC		LBIN	LP
	0	0	0	0	0	0	0	0
7	X'04' (Parameter Length)							
8	(MSB) Counter Value (LSB)							
9								
10								
11								

The Counter Value indicates the count of all posted recovered (01/xx/xx) errors to the interface during verify operations.

4.2.5.5 Total verify bytes processed (Page 05, Code 0005)

Byte \ Bit	7	6	5	4	3	2	1	0
4	(MSB) X'0005' (Parameter code) (Total Bytes Processed) (LSB)							
5								
6	DU	DS	TSD	ETC	TMC		LBIN	LP
	0	0	0	0	0	0	0	0
7	X'0A' (Parameter Length)							
8	(MSB) Total Verify Bytes Processed (10 bytes) (LSB)							
9								
~								
~								
16								
17								

The Total Verify Bytes Processed indicates the total processed bytes during verify operation.

4.2.5.6 Total posted unrecoverable verify errors (Page 05, Code 0006)

Byte \ Bit	7	6	5	4	3	2	1	0
4	(MSB) X'0006' (Parameter code) (Total Posted Unrecoverable Errors) (LSB)							
5								
6	DU	DS	TSD	ETC	TMC		LBIN	LP
	0	0	0	0	0	0	0	0
7	X'04' (Parameter Length)							
8	(MSB) Counter Value (LSB)							
9								
10								
11								

The Counter Value indicates the count of all posted unrecovered errors (03/xx/xx) to the interface during verify operations.

4.2.6 Non-medium error count page (X'06')

Byte \ Bit	7	6	5	4	3	2	1	0
0	0	0	0	0	0	1	1	0
1	X'00' (Reserved)							
2	X'00' (Page Length)							
3	X'08' (Page Length)							
4	(MSB) X'0000' (Parameter code) (Non-medium Error Count) (LSB)							
5								
6	DU	DS	TSD	ETC	TMC		LBIN	LP
	0	0	0	0	0	0	0	0
7	X'04' (Parameter Length)							
8	(MSB) Counter Value (LSB)							
9								
10								
11								

The Counter Value indicates the count of all non-medium errors (01/xx/xx, 02/xx/xx, 04/xx/xx, 05/xx/xx, 06/xx/xx, 07/xx/xx, 09/xx/xx and 0B/xx/xx) posted to the interface.

Implementation:

If a non-medium error is posted, it will force a save of all error log pages information.

4.2.7 Temperature page (X'0D')

Byte \ Bit	7	6	5	4	3	2	1	0
0	0	0	0	0	1	1	0	1
1	X'00' (Reserved)							
2	Page Length (MSB)							
3	Page Length (LSB)							

All of the following parameters have this header.

Page Length will be defined based on the value of Parameter Pointer. (CDB 5-6)

4.2.7.1 Temperature (Page 0D, Code 0000)

Byte \ Bit	7	6	5	4	3	2	1	0
4	(MSB) X'0000' (Parameter code) (LSB)							
5								
6	DU	DS	TSD	ETC	TMC		LBIN	LP
	0	1	0	0	0	0	1	1
7	X'02' (Parameter Length)							
8	X'00' (Reserved)							
9	Temperature (degrees Celsius)							

The Temperature sensed in the device at the time the LOG SENSE command is performed shall be returned in the parameter code 0000h. The one byte binary value specifies the temperature of the device in degrees Celsius. Temperatures equal to or less than zero degrees Celsius shall be indicated by a value of zero. If a valid temperature cannot be detected because of a sensor failure or other condition, the value returned shall be FFh. If EWASC (mode page 1C) is on, comparison is performed between the temperature value specified in parameter 0000h and the reference temperature specified in parameter 0001h.

4.2.7.2 Reference temperature (Page 0D, Code 0001)

Byte \ Bit	7	6	5	4	3	2	1	0
4	(MSB) X'0001' (Parameter code) (Temperature) (LSB)							
5								
6	DU	DS	TSD	ETC	TMC		LBIN	LP
	0	1	0	0	0	0	1	1
7	X'02' (Parameter Length)							
8	X'00' (Reserved)							
9	Reference Temperature (degrees Celsius)							

The Reference Temperature reflect the maximum reported sensor temperature in degrees Celsius at which the device can operate continuously without degrading the device's operation or reliability outside the limits specified by the manufacturer of the device.

4.2.8 Start-stop cycle counter page (X'0E')

Byte \ Bit	7	6	5	4	3	2	1	0
0	0	0	0	0	1	1	1	0
1	X'00' (Reserved)							
2	Page Length (MSB)							
3	Page Length (LSB)							

All of the following parameters have this header.

Page Length will be defined based on the value of Parameter Pointer. (CDB 5-6)

4.2.8.1 Date of manufacture (Page 0E, Code 0001)

Byte \ Bit	7	6	5	4	3	2	1	0
4	(MSB) X'0001' (Parameter code) (Date of Manufacture) (LSB)							
5								
6	DU	DS	TSD	ETC	TMC		LBIN	LP
	0	1	0	0	0	0	0	1
7	X'06' (Parameter Length)							
8	(MSB) Year of manufacture (4 ASCII characters) (LSB)							
9								
10								
11								
12	(MSB) Week of manufacture (2 ASCII characters) (LSB)							
13								

The year and week in the year that the device was manufactured shall be set in the parameter field defined by parameter code 0001h. The date of manufacture shall not be savable by the application client using the LOG SELECT command. The date is expressed in numeric ASCII characters (30h-39h) in the form YYYYWW, as shown above.

4.2.8.2 Accounting date (Page 0E, Code 0002)

Byte \ Bit	7	6	5	4	3	2	1	0
4	(MSB) X'0002' (Parameter code) (Accounting Date) (LSB)							
5								
6	DU	DS	TSD	ETC	TMC		LBIN	LP
	0	0	0	0	0	0	0	1
7	X'06' (Parameter Length)							
8	(MSB) Accounting date Year (4 ASCII characters) (LSB)							
9								
10								
11								
12	(MSB) Accounting date week (2 ASCII characters) (LSB)							
13								

The Accounting date specified by parameter code 0002h is a parameter that may be savable using a LOG SELECT command to indicate when the device was placed in service. If the parameter is not yet set or is not settable, the default value placed in the parameter field shall be 6 ASCII blank characters (20h). The field shall not be checked for validity by the device server.

4.2.8.3 Specified cycle count over device lifetime (Page 0E, Code 0003)

Byte \ Bit	7	6	5	4	3	2	1	0
4	(MSB) X'0003' (Parameter code) (Specified Cycle Count Over Device Lifetime) (LSB)							
5								
6	DU	DS	TSD	ETC	TMC		LBIN	LP
	0	1	0	0	0	0	1	1
7	X'04' (Parameter Length)							
8	(MSB) Specified Cycle Count Over Device Lifetime (4-byte binary number) (LSB)							
9								
10								
11								

The Specified cycle count over device lifetime is a parameter provided by the device sever. The specified cycle count over device lifetime parameter shall not be savable by the application client using the LOG SELECT command. The parameter value is a 4-byte binary number. The value indicates how operation or reliability outside the limits specified by the manufacture of the device.

4.2.8.4 Start-stop cycle counter (Page 0E, Code 0004)

Byte \ Bit	7	6	5	4	3	2	1	0
4	(MSB) X'0004' (Parameter code) (Accumulated Start-Stop Cycles) (LSB)							
5								
6	DU	DS	TSD	ETC	TMC		LBIN	LP
	0	1	0	0	0	0	1	1
7	X'04' (Parameter Length)							
8	(MSB) Accumulated Start-Stop Cycles (4-byte binary number) (LSB)							
9								
10								
11								

The Accumulated start-stop cycles is a parameter provided by the device sever. The accumulated start-stop cycles parameter shall not be savable by the application client using the LOG SELECT command. The parameter value is a 4-byte binary number. The value indicates how many start-stop cycles the device has detected since its date of manufacture. For rotating magnetic storage device, a single start-stop cycle is defined as an operational cycle that begins with the disk spindle at rest, continues while the disk accelerates to its normal operational rotational rate, continues during the entire period the disk is rotating, continues as the disk decelerates toward a resting state, and ends when the disk is no longer rotating. The count is incremented by one for each complete start-stop cycle. No comparison with the value of parameter 0003h shall be performed by the device server.

4.2.9 Application client page (X'0F')

Byte \ Bit	7	6	5	4	3	2	1	0
0	0	0	0	0	1	1	1	1
1	X'00' (Reserved)							
2	Page Length (MSB)							
3	Page Length (LSB)							

All of the following parameters have this header.

Page Length will be defined based on the value of Parameter Pointer. (CDB 5-6)

4.2.9.1 General usage application client parameter data (Page 0F, Code 0000-003F)

Byte \ Bit	7	6	5	4	3	2	1	0
4	(MSB) X'0000'-X'003F' (Parameter code) (Application Client Parameter) (LSB)							
5								
6	DU	DS	TSD	ETC	TMC		LBIN	LP
	1	0	0	0	0	0	1	1
7	X'FC' (Parameter Length)							
8	(MSB) General Usage Paramter Bytes (LSB)							
9								
~								
~								
258								
259								

The values stored in the General usage parameter bytes represent data sent to the device server in a previous LOG SELECT command. If a previous LOG SELECT command has not occurred, the data is zero.

4.2.10 Self-test result page (X'10')

Byte \ Bit	7	6	5	4	3	2	1	0
0	0	0	0	1	0	0	0	0
1	X'00' (Reserved)							
2	Page Length (MSB)							
3	Page Length (LSB)							

All of the following parameters have this header.

Page Length will be defined based on the value of Parameter Pointer. (CDB 5-6)

4.2.10.1 Self-test result parameter data (Page 10, Code 0001-0014)

Byte \ Bit	7	6	5	4	3	2	1	0
4	(MSB) X'0001'-X'0014' (Parameter code) (LSB)							
5								
6	DU	DS	TSD	ETC	TMC		LBIN	LP
	0	0	0	0	0	0	1	1
7	X'10' (Parameter Length)							
8	Self-Test Code			0	Self-Test Result Value			
9	Self-Test Segment Number							
10	(MSB) Time Stamp (LSB)							
11								
12	(MSB) Address of First Failure (LSB)							
~								
19								
20	0	0	0	0	Sense Key			
21	Additional Sense Code							
22	Additional Sense Code Qualifier							
23	X'xx' (Vendor-specific)							

When the self-test is initiated, the value specified in the SELF-TEST CODE field in the CDB is reported to the SELF-TEST CODE field by a SEND DIAGNOSTICS command.

The values reported to the “Self-Test Result Value” field are defined below.

Table 4.3 Self-test results values

Value	Description
0h	The self-test completed without error.
1h	The background self-test was aborted by the application client using a SEND DIAGNOSTICS command with the SELF-TEST CODE field set to 100b (Abort background self-test).
2h	The self-test routine was aborted by an application client using a method other than a SEND DIAGNOSTICS command with the SELF-TEST CODE field set to 100b (e.g., by the ABORT Task, RESET CONDITION, or reception of an interrupt command as described in Section 4.2).
3h	An unknown error occurred while the device server was executing the self-test and the device server was unable to complete the self-test.
4h	The self-test completed with a failure in a test segment, and the test segment that failed is not known.
5h	The first segment of the self-test failed.
6h	The second segment of the self-test failed.
7h	Another segment of the self-test failed (see the SELF-TEST SEGMENT NUMBER field).
8h - Eh	Reserved
Fh	The self-test is in progress.

The number of the segment that failed during the self-test is shown in the “Self-Test Segment Number” field. When the self-test is completed without an error, 0 is shown in the field.

The accumulated power-on time (unit: hour) in the event of an error occurring in the drive is shown in the “Time Stamp” field.

Address information of the data block where that error occurred is shown in the “Address of First Failure” field.

The error information in the same format as that used by sense data is reported to the “Sense Key,” “Additional Sense Code,” and “Additional Sense Code Qualifier” fields.

4.2.11 Background medium scan page (X'15')

Note:

These parameters ("4.2.11.1 Background medium scan status parameter" and "4.2.11.2 Background medium scan parameter") are not supported. In LOG SENSE, these parameters are not transferred.

Byte \ Bit	7	6	5	4	3	2	1	0
0	0	0	0	1	0	1	0	1
1	0	0	0	0	0	0	0	0
2	Page Length (MSB)							
3	Page Length (LSB)							

All of the following parameters have this header.

Page length will be defined based on the value of Parameter Pointer (CDB 5-6).

4.2.11.1 Background medium scan status parameter

Byte \ Bit	7	6	5	4	3	2	1	0
4	(MSB) X'0000' (Parameter code)							
5	(LSB)							
6	DU	DS	TSD	ETC	TMC		LBIN	LP
	0	0	0	0	0	0	1	1
7	X'0C' (Parameter Length)							
8	(MSB) Time Stamp							
9								
10								
11								
12	Reserved							
13	BMS Status							
14-15	Number of Scans Performed							
16-17	Medium Scan Progress							
18	Reserved							
19	Reserved							

The accumulated power-on time (unit: minute) at processing the LOG SENSE command is shown in the "Time Stamp" field.

The values reported to the "BMS Status" field are defined below.

Value	Description
0h	No medium scan
1h	Background medium scan in progress
2h	Pre-Scan in progress
3h	Halt the Medium Scan due to fatal error
4h	Halt the Medium Scan due to vendor specific pattern of errors
5h	Halt the Medium Scan due to medium formatted without the P-List
6h	Reserved
7h	Halt the Medium Scan due to Irregular Temperature condition
8h	Scan suspended until BMS Interval Timer

The execution time of the Medium Scan operation is shown in the "Number of Scans Performed" field.

The progressing rate of the Medium Scan operation is shown in the "Medium Scan Progress" field.

4.2.11.2 Background medium scan parameter

Byte \ Bit	7	6	5	4	3	2	1	0
0	(MSB) X'0001' - X'0800' (Parameter code) (LSB)							
1								
2	DU	DS	TSD	ETC	TMC		LBIN	LP
	0	0	0	0	0	0	1	1
3	X'14' (Parameter Length)							
4	(MSB) Time Stamp (LSB)							
5								
6								
7								
8	Reassign Status				Sense Key			
9	Additional Sense Code							
10	Additional Sense Code Qualifier							
11	Vender Specific (0x00)							
15								
16	(MSB) LBA (LSB)							
23								

The values reported to the "Reassign Status" field are defined below

Value	Description
0h	No Reassign operation
1h	Waiting a command (REASSIGN BLOCK or WRITE) from the application client
2h	Automatic Reassign done
3h	Reserved
4h	Reassign failed
5h	Retrieval with Re-Write operation
6-Fh	Reserved

The Error occurred LBA Number is shown in the "LBA" field.

4.2.12 SMART status page (X'2F')

[Fujitsu unique page]

Byte	Bit								
		7	6	5	4	3	2	1	0
0		0	0	1	0	1	1	1	1
1		X'00' (Reserved)							
2		Page Length (MSB)							
3		Page Length (LSB)							
4									
~									
n									

This page contains parameters which allow the application client to check the predictive drive failure condition of the IDD. The application client can check whether the IDD has predicted a drive failure by periodically reading out this page.

The "Page Length" field indicates the length (byte length) after byte 4.

The "SMART Status Parameter" field is Fujitsu unique parameters. The details of this field are outside the scope of this manual.

4.2.13 SMART data page (X'38')

[Fujitsu unique page]

Byte \ Bit	7	6	5	4	3	2	1	0
0	0	0	1	1	1	0	0	0
1	X'00' (Reserved)							
2	Page Length (MSB)							
3	Page Length (LSB)							
4								
~								
n								

This page reports data which the IDD collects for predicting drive failures.

The "Page Length" field indicates the length (byte length) after byte 4.

The "Log Parameters" field is Fujitsu unique parameters. The details of this field are outside the scope of this manual.

CHAPTER 5 **Sense Data Error Recovery Methods**

5.1 Sense Data

5.2 INIT Error Recovery Methods (Recommended)

5.3 Disk Drive Error Recovery Processing

In this chapter, the configuration and contents of sense data reported to the INIT (initiator) when an error occurs, etc., key information for interpreting error states, recommended procedures for error recovery processing that should be executed by software in the INIT and error recovery processing executed internally by the IDD are described. Furthermore, see Chapter 3, “SCSI Bus Error Recovery Processing” in the “SCSI Physical Interface Specifications” concerning recovery processing for errors detected in operations on the SCSI bus.

5.1 Sense Data

When the IDD reports a CHECK CONDITION status, or in cases when some fatal error is detected in connection with the SCSI bus, and as a result, the command that is currently being executed, or the commands in the stack are cleared, it generates sense data for the INIT that issued that command. The INIT can fetch the sense data by issuing a REQUEST SENSE command.

5.1.1 Sense data format

The IDD’s sense data is in the so-called “Expanded Sense Data” format. The expanded sense data format supported by the IDD is shown in Figure 5.1.

Notes:

1. In the SCSI specifications, each device is permitted to define whatever it chooses after byte 18 of the expanded sense data, and the length and format differ for each device. The length of expanded sense data is displayed in the sense data, so by analyzing the sense data which it receives, the INIT can know its effective length.
2. In the REQUEST SENSE command, even if a Transfer byte length that is shorter than the length of the sense data supported by the device which is the object of the command, the command will terminate normally, but in that case, some of the sense data only will be received and the remaining information will be lost. Sufficient caution should be exercised with regard to the devices connected to the INIT and all the sense data of those devices should be read.

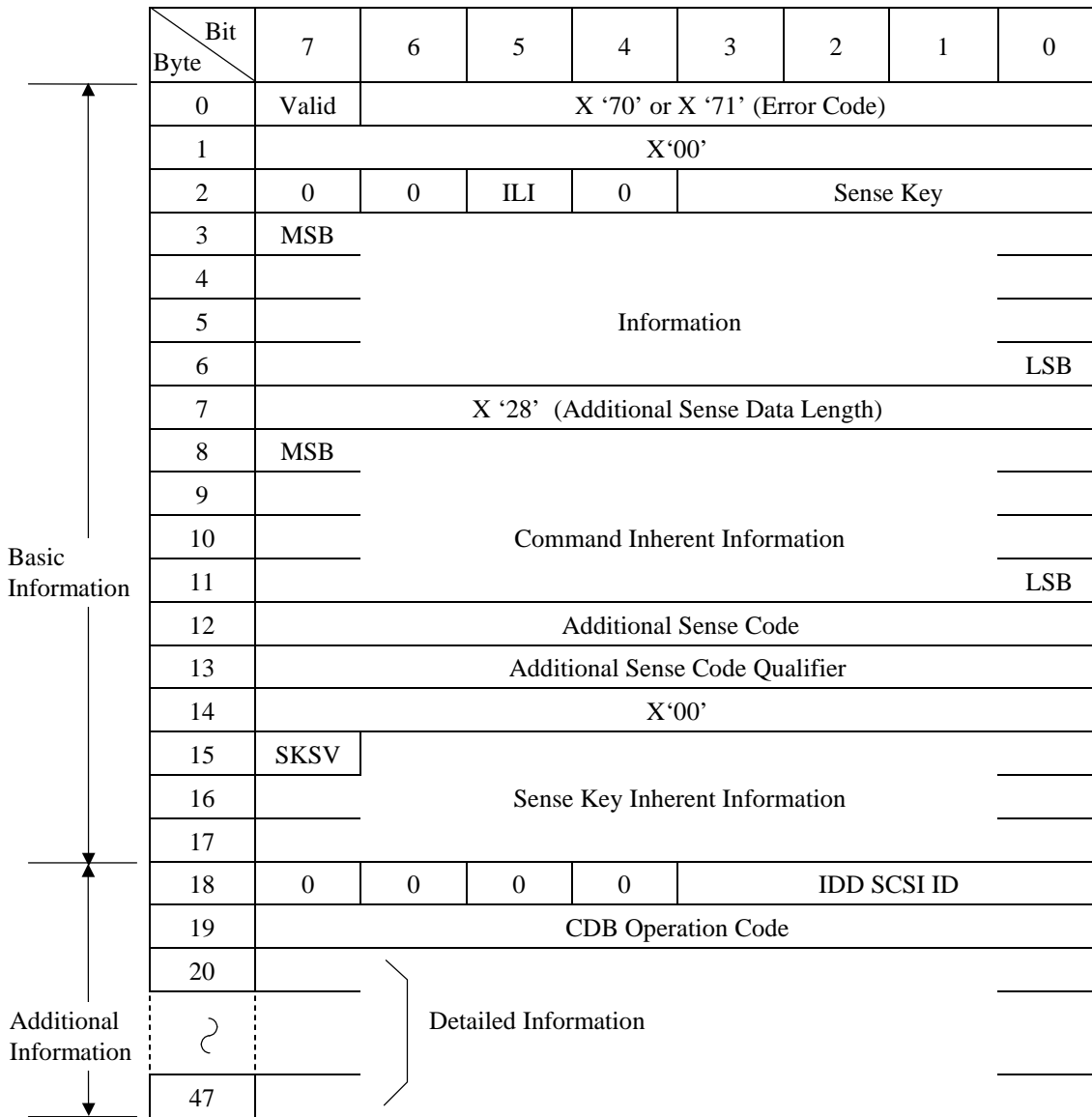

Figure 5.1 Expanded sense data format

5.1.2 Sense data basic information

Bytes 0 to 17 of the sense data are basic information which show the contents of the error that has occurred. The INIT can know the contents of the error and the key information that is necessary for recovery processing by analyzing this basic information. Each field and the meanings of bits in the sense data basic information are explained below.

- (1) Valid

When this bit is “1,” it indicates that the values shown in the information field (bytes 3 to 6) are valid. On the other hand, when this bit is “0”, it indicates that the information field does not contain valid information.

(2) Error code

This field shows the format and type of sense data. The IDD always displays X '70' (current error) or X '71' (deferred error), which has the meaning "expanded sense data format" in this field.

(3) ILI (incorrect length indicator)

When this bit is "1," it indicates that the transfer byte length requested in the command did not coincide with the data block length on the disk media. In the IDD, the only commands that it reports "1" in this bit for are the READ LONG command and the WRITE LONG command. For details, refer to the descriptions of these commands (Sections 3.4.5 and 3.4.6).

(4) Sense key

This field shows the cause of the sense data being generated. More details reasons are indicated in the additional sense code field (Byte 12) and the additional sense code qualifier field (Byte 13). Table 5.1 shows a list of the meanings of sense keys.

(5) Information

This field shows information related to the error that has been detected and is valid only when the Valid bit is "1." Depending on the command where the error occurred, additional information other than the information in this field may be indicated in the command inherent information field. The information shown in this field has the following meanings depending on the value of the "ILI" bit.

- a) When the "ILI" bit is "0," the logical block address of the data block where the error occurred is indicated.
- b) When the "ILI" bit is "1," the difference between the transfer byte length requested by the command and the actual data block length on the disk media is indicated. If the difference is a minus value, (if the request transfer byte count is smaller), it is expressed as a complement of 2. In the IDD, only the READ LONG command and the WRITE LONG command display this information. For details, see the descriptions of these commands (Sections 3.4.5 and 3.4.6).

(6) Additional sense data length

This field indicates the length (number of bytes) after byte 8 of the sense data. The value shown in this field shows the length of sense data provided by the IDD without relation to the value specified in the "Transfer byte length" in the CDB of the REQUEST SENSE command. The length of the IDD's sense data is fixed at 48 bytes and this field always indicates X '28' (40 bytes).

(7) Command inherent information

This field indicates information that is inherent to the command where the error occurred. The only command for which the value in this field is valid in the IDD is the REASSIGN BLOCKS command. See the description of the REASSIGN BLOCKS command (Section 3.3.2) concerning details of the information shown in this field.

- (8) Additional sense code, additional sense code qualifier

The codes which indicate the reason for the error displayed by the sense key in detail are reported in these fields. The INIT can decide procedures for error recovery according to the sense key and these fields. The additional sense code and additional sense code qualifier are defined in Table 5.2.

- (9) SKSV (sense key specific valid), sense key inherent information

When the sense key indicates one of “RECOVERED ERROR [=1],” “MEDIUM ERROR [=3]” or “HARDWARE ERROR [=4],” and the “SKSV” bit indicates “1,” indicates the number of times the IDD has attempted to recover from the detected error as shown in Figure 5.2 (a).

When the sense key indicates “NOT READY [=2]” and the “SKSV” bit indicates “1,” indicates the progressing rate of the formatting operation by the FORMAT UNIT command with [n/65536] as shown in Figure 5.2 (b) or the progressing rate of the drive self-test operation by the SEND DIAGNOSTICS command (Self-Test = 0).

- (a)

Bit Byte	7	6	5	4	3	2	1	0
15	SKSV	0	0	0	0	0	0	0
16	X'00'							
17	Number of retries executed							

- (b)

Bit Byte	7	6	5	4	3	2	1	0	
15	SKSV	0	0	0	0	0	0	0	
16	[MSB]	Progressing rate of formatting							
17		or Progressing rate of Self-Test operation						[LSB]	

Figure 5.2 Sense key inherent information

Table 5.1 Sense key

Sense Key	Name	Explanation
0	NO SENSE	The specific sense key does not exist.
1	RECOVERED ERROR	1) Indicates that the command which was executed last was terminated normally with a recovery operation by the IDD. If multiple errors which were successfully recovered from during processing of a single command occurred, the last error to have occurred is reported. 2) Rounding processing of the MODE SELECT parameter was performed.
2	NOT READY	The disk drive is not in a state where it can be accessed.
3	MEDIUM ERROR	An irrecoverable error was detected due to a defect in the disk media or an error in the recorded data.
4	HARDWARE ERROR	The IDD detected an error in the hardware for which recovery processing is impossible during command execution or self-diagnosis.
5	ILLEGAL REQUEST	An illegal value was detected in the parameter transferred in the CDB or the specification in the command. Also, an error in the LUN specification. If the IDD detects an illegal parameter in the CDB, it terminates the command without changing the contents of the disk media. If an illegal parameter is detected in the parameters transferred from the INIT in the DATA OUT phase, the contents of the disk media may be changed by that command.
6	UNIT ATTENTION	A UNIT ATTENTION condition occurred. (See Section 1.5 concerning details of the UNIT ATTENTION condition.)
7	DATA PROTECT	1) An illegal operation was attempted in an area where a read or write operation is prohibited. In this case, that command is not executed. 2) A SET LIMITS command was issued 2 times in a group of commands linked in a series.
8	BLANK CHECK	Not Used
9	(Reserved)	Not Used
A	COPY ABORTED	Not Used
B	ABORTED COMMAND	The IDD terminated a command abnormally during execution. Normally, the INIT can attempt to recover by reissuing that command.
C	EQUAL	Not Used
D	VOLUME OVERFLOW	Not Used
E	MISCOMPARE	During execution of a Byte Check with the VERIFY command, the data transferred from the INIT were compared to the data read from the disk drive, but they did not match.
F	(Reserved)	Not Used

Table 5.2 Additional sense code and additional sense code qualifier (1 of 6)

C*	Q*	Name	Explanation	Sense key
00	00	No additional sense information	No specific additional sense code exists.	0
	06	I/O process terminated	I/O was interrupted by the Terminated I/O Process message.	0
01	00	No index/sector signal	The target sector was not detected by the sector counter within the specified time.	4
03	00	Peripheral device write fault	A write operation to the disk media was terminated abnormally. • Off track during write.	1, 3, B
	80	Peripheral device write fault	A write operation to the disk media was terminated abnormally. • Write current abnormality	1, 4, B
	82	Peripheral device write fault	A write operation to the disk media was terminated abnormally. • Servo mark not found during write.	1, 3, B
	83	Peripheral device write fault	A write operation to the disk media was terminated abnormally. • Servo cell detected was detected during write. • Write gate and sector pulse were activated at the same time during write.	1, 4, B
	87	Peripheral device write fault	A write operation to the disk media was terminated abnormally. • No write gate detected	1, 4, B
04	01	Logical unit in process of becoming ready	Disk drive is getting ready. (The spindle motor is not at its regular rotation speed or has reached its regular rotation speed but is still reading the information)	2
	02	Logical unit not ready	Disk drive is in start command waiting state. (initializing command required)	2
	04	Logical unit not ready, format in progress	The drive cannot be accessed since it is being formatted.	2
	09	Logical unit not ready, Self-Test in progress	The drive cannot be accessed since it is being Self-Test.	2
	F0	Microcode Revision ady, UNMATCH (Counterfeit Detected)	The drive detected the Firmware Revision Unmatch between SA Area and F-ROM.	2
0B	01	Specified temperature exceeded	Temperature exceeded established value.	0, 1, 6
0C	01	Write error recovered with auto reallocation	A write error was recovered with auto reallocation.	1
	02	Write error – auto reallocation failed	Write auto reallocation or the write that was applied to auto reallocation was failed.	3
	03	Write Error	Unrecovered Write Offtrack Error • Write retries are exhausted in case of AWRE = 0	3
	80	Write Error • Unrecovered Write Offtrack Error	Reported if a write offtrack occurred during the Format unit command execution.	3
	81	Write Error Recovered	Write Error Recovered With Servo Auto Reallocation.	1

* C: Additional Sense Code, Q: Additional Sense Code Qualifier

Table 5.2 Additional sense code and additional sense code qualifier (2 of 6)

C*	Q*	Name	Explanation	Sense key
11	00	Unrecovered Read Error	Unrecovered read error occurs during reading data field (LBA Mismatch Error detected by SCSI portion)	3
	01	Read retries exhausted	Unrecovered error was detected during data read (retry out).	3, B
	02	Error too long to correct	Unrecovered error was detected during data read (BCRC error detected by SCSI)	3, B
	04	Unrecovered read error, auto reallocation failed	Auto allocation failed during read.	3
13	00	Sync Byte not found for Data field	SB (Sync Byte) could not be detected in the Data area.	1, 3, B
14	00	Record entity not found	Expected data from a sector was undetected. (LBA compare error detected by FMT)	1, 3, B
	01	Record not found	The target data block (sector) could not be detected.	1, 3, B
15	01	Mechanical positioning Error	A seek error occurred in the drive.	1, 3, B
	02	Positioning Error detected by read of medium	LBA did not match due to Cylinder number's mismatch.	1, 3, B
17	01	Recovered data with retries	A data error was recovered from by reading was retried.	1
	02	Recovered data with positive head offset	A data error was recovered by read retry with offsetting head to positive direction.	1
	03	Recovered data with negative head offset	A data error was recovered by read retry with offsetting head to negative direction.	1
	06	Recovered data without ECC: data auto-reallocated	Automatic alternate allocation was applied without ECC correcting a data error.	1
	08	Recovered data without ECC: recommended rewrite	Rewriting to the same sector was performed without ECC correcting a data error.	1
18	00	Recovered Data with Error Correction Applied	A data error was recovered by read retry with ECC correcting.	1
19	02	Defect list error in primary list	An error was detected during reading of the defect list (P List).	3
	03	Defect list error in grown list	An error was detected during reading of the defect list (G List).	3
	80	Log information read error	An error was detected during reading of statistical information.	3
	81	Log information write error	A write error was detected during writing of statistical information.	3
	84	Mode Select SA write Error	An error was detected during writing of SA information (Mode Select Parameter)	3
	Ax	Drive Parameter SA write Error	An error was detected during writing of SA information (Device Information)	3
	Bx	Drive Parameter SA write Error	An error was detected during writing of SA information (Device Information)	3
1A	00	Parameter list length error	There is a mistake in the indication of the parameter list page length.	5

* C: Additional Sense Code, Q: Additional Sense Code Qualifier

Table 5.2 Additional sense code and additional sense code qualifier (3 of 6)

C*	Q*	Name	Explanation	Sense key
1B	00	Synchronous Data Transfer Error	An error (timeout) was detected during synchronous data transfer on SCSI bus by Synchronous Transfer Timeout function.	B
1C	01	Primary defect list not found	The defect list (P List) header is incorrect.	3
	02	Grown defect list not found	The defect list (G List) header is incorrect.	3
	90	SA information list not found	The SA information (MODE SELECT parameter) header is incorrect.	3
1D	00	Miscompare during verify operation	Comparison of data transferred from the INIT by a VERIFY command (when the Byte Check mode was specified) with data read from the disk media was terminated unsuccessfully.	E
	80	Miscompare during self-configuration	There is an unmatched to compare read data with write data during self-configuration.	E
1F	00	Partial Defect List Transfer	Read Defect Data command (37h) cannot transfer all the Defect data in the target because the numbers of defect exceeded the maximum.	1
20	00	Invalid command operation code	CDB byte 0 (operation code) is illegal.	5
21	00	Logical block address out of range	A logical block address which exceeds the drive's maximum value was specified.	5
24	00	Invalid field in CDB	There is an error in a specification in the CDB.	5
25	00	Logical unit not supported	An illegal LUN was specified.	5
26	00	Invalid field in parameter list	There is an error in the parameter list specifications transferred from the INIT during command execution.	5
	04	Invalid Release of Persistent Reservation	There is unmatched valid reservation status in the parameter list specifications	5
27	00	Write protected	A write operation was attempted in a write protected area. Or a write operation is prohibited at the external operation panel.	7
29	01	Power on occurred	Power On occurred.	6
	02	SCSI reset occurred	A SCSI RESET was received.	6
	03	TARGET RESET message occurred	A TARGET RESET message was received.	6
	05	Transceiver mode changed to Single-Ended	Transceiver mode was changed to Single-Ended mode.	6
	06	Transceiver mode changed to LVD	Transceiver mode was changed to LVD mode.	6
2A	01	Mode parameter changed	The MODE SELECT parameter values were changed by another INIT.	6
	03	Reservations preempted	A persistent reserve state was cleared by another INIT.	6
	04	Reservations released	A persistent reserve state was released	6
	05	Registrations preempted	A persistent reserve state was preempted by another INIT.	6
2F	00	Command cleared by another INIT	A command was forcibly terminated by another INIT during execution or queuing. <ul style="list-style-type: none"> • By a CLEAR QUEUE message • The sense hold state was entered when the QErr bit was set on "1." • The DQue bit was changed from "0" to "1." 	6

* C: Additional Sense Code, Q: Additional Sense Code Qualifier

Table 5.2 Additional sense code and additional sense code qualifier (4 of 6)

C*	Q*	Name	Explanation	Sense key
31	00	Medium format corrupted	The media format is different from the original format. (The media was not formatted after the data format specification was changed by the MODE SELECT command.)	3
	01	FORMAT command failed	For some reason, formatting cannot be completed and reformatting is necessary.	3
32	00	No defect spare location available	No usable alternate block area exists. Or alternate block processing cannot be performed due to control table overflow.	4
	01	Defect list update failure	Updating of the defect list (G List) failed.	4
37	00	Rounded parameter	Rounding processing of the MODE SELECT parameter specified by the command was performed.	1
3D	00	Invalid bits in IDENTIFY message	"1" was specified in the reserve bit of the IDENTIFY message.	5
3E	03	Logical unit failed Self-Test	The test segment error occurred during the Self-Test	4
	04	Logical unit unable to update	The IDD failed to update the Self-Test result log	4
3F	01	Microcode has been changed	Microcode was changed by another INIT.	6
	02	Changed operating definition	Operating definition was changed.	6
	05	Device identifier changed	Device identifier was changed.	6
40	nn	Diagnostic failure on component "nn"	An error was detected in self-diagnosis. ("nn" is a Fujitsu unique code) <ul style="list-style-type: none"> • 81: Buffer RAM compare error/bus error • 82: Program RAM compare error/bus error • 83: HDC register check error • 84: Firmware header/check sum error • 85: Firmware type unmatched • 86: Parameter header/check sum error • 88: Drive Serial No. unmatched • 89: DE type unmatched • 8F: Other MPU peripheral circuit diagnostic error • 92: Spindle motor firmware initialize error 	4
43	00	Message error	A message sent by the IDD was illegally rejected.	B

* C: Additional Sense Code, Q: Additional Sense Code Qualifier

Table 5.2 Additional sense code and additional sense code qualifier (5 of 6)

C*	Q*	Name	Explanation	Sense key
44	nn	Internal target failure	<p>An error was detected in self-diagnosis. ("nn" is a Fujitsu unique code)</p> <ul style="list-style-type: none"> • 90: Next sector IDD compare error • 91: WCS RAM parity error • 92: Unexpected FMT interrupt • 94: NRZ parity error during Write (MAS3*** Series only) • 99: Overflow error occurred at SPC FIFO • 9A: Unexpected SPC interrupt • 9B: SPC detected illegal command interrupt • 9C: SPC detected illegal write interrupt • 9D: SPC detected Sync offset error interrupt • A0: Error interruption from DBM • A3: DBM buffer CRC error • A4: DBM internal parity error • A8: Data late error • B0: Flash ROM erase operation failed. • B1: Flash ROM write operation failed. • C0: RDCLK error (FMT hang up) • D1: DSP downloading failed • D2: DSP overrun (watch dog time out, DRV hard error) • D3: Servo Gate Window error • D4: Illegal error was reported from DSP 	<p>4</p> <p>B</p> <p>4</p> <p>4, B</p> <p>4</p> <p>4, B</p> <p>4</p> <p>4</p> <p>4</p> <p>4</p> <p>4</p> <p>4</p> <p>4</p>
45	00	Select/Reselect failure	A response wait time-out from the INIT was detected in the RESELECTION phase.	B
47	00	SCSI parity error	A parity error was detected on the SCSI data bus.	B
48	00	INITIATOR DETECTED ERROR message received	The INITIATOR DETECTED ERROR message was received from the INIT.	B
49	00	Invalid message error	An unsupported or inappropriate message was received.	B
4C	nn	Logical unit failed self-configuration	<p>The IDD's initial setup failed. ('nn' is a Fujitsu unique code)</p> <ul style="list-style-type: none"> • 91: Microcode Read error (any 3/11/** error during microcode read) • 93: Microcode Read error (any 3/13/** NOSB error) • 94: Microcode Read error (any 3/14/** NRF error) • 95: Microcode Read error (any 3/15/** error during seek) • 97: Microcode Read error (any 4/44/** or other errors during microcode read) • 98: Invalid microcode (Header/Check Sum) • A1: SA Read error (any 3/11/** error during SA read) • A3: SA Read error (any 3/13/** error during SA read) • A4: SA Read error (any 3/14/** error during SA read) • A5: SA Read error (any 3/15/** error during SA read) • A7: SA Read error (any 4/44/** error during SA read) • A8: Invalid SA (Header/Check Sum) • A9: SA Read error (DSP downloading failed) • AA: SA Read error (DSP overrun/DRV hardware error) • AB: SA Read error (abnormal rotation of spindle motor) • AC: SA Read error (on-track failure) • E0: Initial calibration failed 	4

* C: Additional Sense Code, Q: Additional Sense Code Qualifier

Table 5.2 Additional sense code and additional sense code qualifier (6 of 6)

C*	Q*	Name	Explanation	Sense key
4D	nn	Tagged overlapped command	Before completing one command execution, new command having the same tag number was issued to the same logical unit. (nn=queue tag number)	B
4E	00	Overlapped commands attempted	1) Before execution of an untagged command was completed, the same INIT issued a new command to the same LUN. 2) Before execution of a tagged command was completed, the same INIT issued a command to the same LUN with the same tag. Or, an untagged command was issued when not in the sense hold state.	B
55	04	Insufficient Registration Resource	PERSISTENT RESERVATION OUT command is issued from insufficient device server resource.	5
5C	01	Spindle synchronized	The rotational synchronization operation was completed.	6
	02	Spindle not synchronized.	Rotational synchronization deviated.	6
5D	nn	SMART predictive failure	SMART related sense data <ul style="list-style-type: none"> • 12: The read error rate attribute has reached the failure threshold. • 14: The frequency of grown defect allocation attribute has reached the failure threshold. • 41: SERVO Impending Failure, Data Error Rate Exceeding Limits. • 43: The seek error rate attribute has reached the failure threshold. • 56: The spin up time attribute has reached the failure threshold. • 64: The remaining alternate sector count attribute has reached the failure threshold. • FF: The drive is in test mode. 	0, 1, 6
90	00	Initiator's SCSI ID not identified	Since the SCSI ID of the INIT was not notified in the SELECTION phase, the RESERVE, RESERVE EXTENDED, RELEASE AND RELEASE EXTENDED commands cannot be executed.	5
C4	nn	Drive Failure	A serious error was detected in the drive's control system. ('nn' is a Fujitsu unique code) <ul style="list-style-type: none"> • 00: Abnormal Rotation of Spindle Motor • 01: Any error at Spindle Motor Start • 30: On track failure 	4

* C: Additional Sense Code, Q: Additional Sense Code Qualifier

5.1.3 Sense data additional information

Bytes 18 to 47 of sense data are defined as a Fujitsu unique field, and indicate the additional information which is explained below.

(1) **IDD SCSI ID**

This field shows the SCSI ID of the very IDD which generated the sense data.

(2) **CDB operation code**

This field indicates the operation code (the value in the first byte of the CDB) of the command where the error occurred. When sense data are generated without relation to the INIT issuing a command, this field shows zero.

(3) **Detailed information**

The information displayed in bytes 20 to 47 of sense data is information defined by Fujitsu for the specific product for the purpose of analyzing trouble, and the contents of this information are not made public. However, the user should present this information to the persons in charge at Fujitsu as troubleshooting and repair information collected in error logging (shown in Section 5.3.3) of all the bytes in sense data, including this field.

5.2 INIT Error Recovery Methods (Recommended)

When a single command or a series of linked commands are not terminated with a GOOD status or TASK COMPLETE message reported, the INIT should execute error recovery processing corresponding to the state in which the command was terminated. Here, the procedure for analyzing the command execution termination state and recommended procedures for error recovery processing executed by the INIT in accordance with the results are explained.

5.2.1 Termination status analysis and error recovery methods

Figure 5.3 shows a model of the INIT's general processing flow from issuing of the command until reception of the termination status. In the figure, a "BUS FREE Error" is the case where the SCSI bus entered the BUS FREE phase at a point not intended by the INIT (at a point when entering the BUS FREE phase was not permitted by the SCSI bus protocol specification), and normally, it is an error detected by the host system's (INIT's) SCSI controller's hardware or firmware.

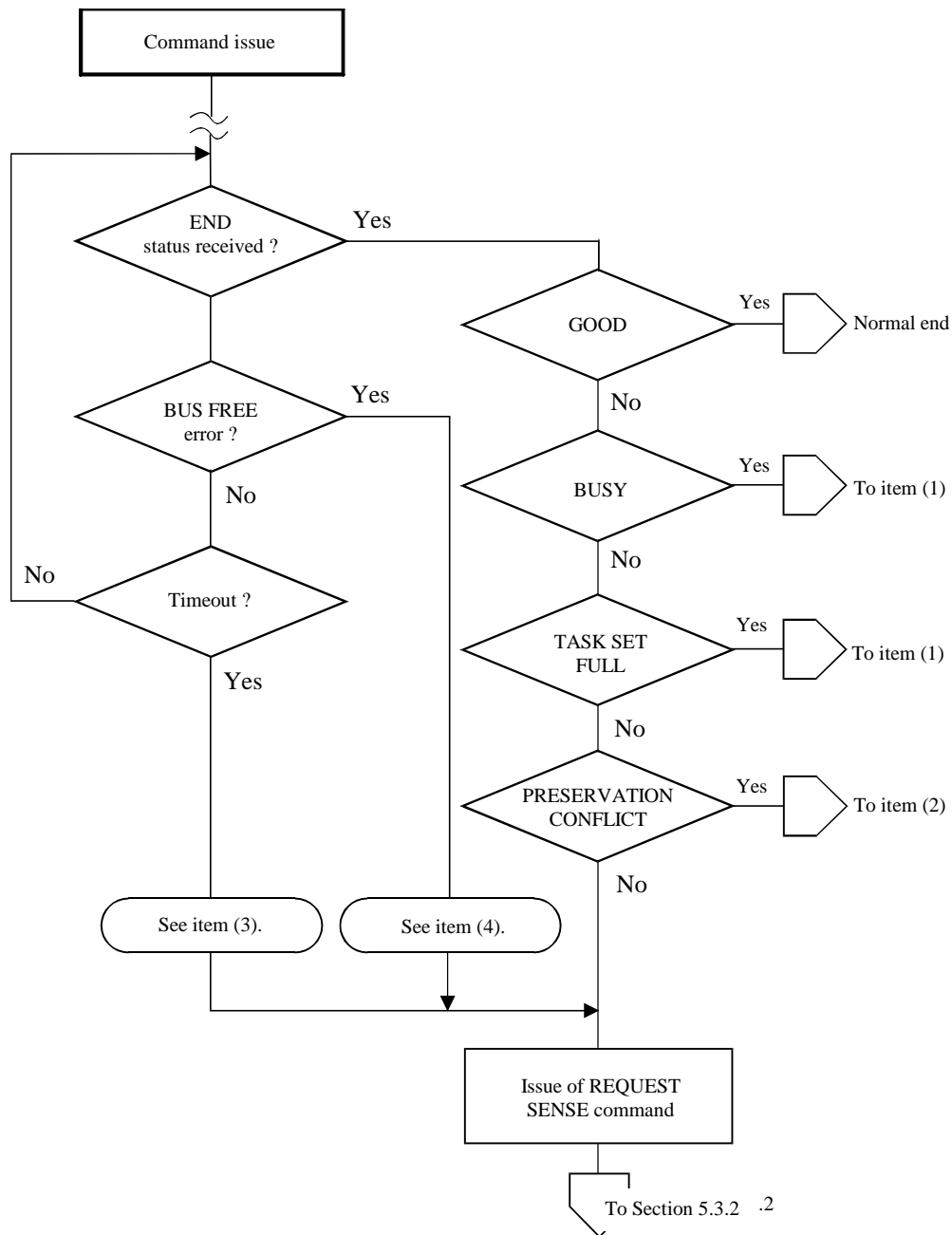

Figure 5.3 Analysis of the termination status

(1) **BUSY/TASK SET FULL status**

This status indicates that the IDD is currently executing processing of another command and that a new command cannot be received. The INIT that receives this status can reissue the original command.

Under a multi-initiator environment, when an INIT receives this status, the time until the IDD can receive the next command depends on the operating state with other INITs, so ordinarily, it cannot be predicted. In such a case, it is necessary for the INIT that issued the command for which this status was received to repeatedly issue the command until it is accepted.

(2) RESERVATION CONFLICT status

This status shows, under a multi-initiator environment, that the IDD is currently reserved by another INIT, and cannot be used until that reserved status is released.

The period over which the reserved status continues should be managed by the system, but normally, an INIT that receives this status reissues the original command after waiting an appropriate length of time. The wait time until a command is reissued is generally an inherent value of the system and it is necessary that consideration be given to the operating states of the other INITs in the system when deciding it.

Of the INIT which reserved the IDD falls into a state which it cannot recover from for any reason before the reserved state is released, it will be impossible for other INITs to access the IDD because that reserved state will continue. In such a case, it is necessary for the INIT to take one of the following measures to forcibly release the reserved state and recover the access right.

- TARGET RESET message
- RESET condition

(3) Command completion wait time-out

This error is a state where the completed status for a command is not reported within the time expected by the INIT that issued the command.

One cause of this error occurring, besides a malfunction of the IDD, is that the command was cleared by some method which the INIT that issued the command cannot clearly detect, such as a TARGET RESET message, or the command was cleared when an unrecoverable error was detected in reconnection processing executed by the IDD, etc. When this error occurs, the INIT should gather sense data by issuing the REQUEST SENSE command, then judge which recovery method to use based on the contents of the sense data (see Section 5.2.2).

Not only does command execution time differ widely depending on the type and specified contents of the command, but since it has an influence on the following factors, it is necessary to give adequate consideration to these points when setting the monitoring time value at the INIT.

- Since the command stack feature exists (see Section 1.4), even if the IDD accepts a command normally, if a command issued by another INIT is being executed, or if there are other commands in the stack, execution of the command is caused to wait until all the other commands have been processed. The execution wait time is dependent upon the type of command issued by the other INITs and the contents of its specifications.
- If the IDD has executed error recovery processing (retried) for an error that occurred on the SCSI bus or in the disk drive, command completion time will be longer than normal.

(4) BUS FREE error

This error occurs in the case that the SCSI bus enters the BUS FREE phase at a time when the INIT is not expecting it, during execution of a command on the SCSI bus. Even in cases where a RESET condition is generated by another SCSI device on the bus, the same state occurs, but the occurrence of an unexpected RESET condition should be processed as an abnormal state of the system.

Table 5.3 Sense data error classification (4 of 4)

K*	C*	Q*	Error contents	L*	Recovery method (See Table 5.4.)
B	4E	00	Overlapped commands attempted Before execution of a command was completed, a new command was issued by the same INIT.	None	2
	4D	nn	Tagged overlapped commands		
E	1D	00	Miscompare during verify operation Data failed to match in the Byte check mode of the Verify command.	None	24

* K: Sense Key C: Additional Sense Code
Q: Additional Sense Code Qualifier L: Logging Necessary? (shown in Section 5.2.3)

Table 5.4 Error recovery processing procedures (1 of 5)

Recovery Method	Recovery Processing Procedure
0	It is not necessary to perform the error recovery processing. Continue processing.
1	Error recovery processing is impossible. Terminate processing.
2	This is a programming error and error recovery processing is impossible. Terminate processing and correct the error in the system (INIT) programming.
3	This is an error in the SCSI protocol and error recovery processing is impossible. Terminate processing and check the system's SCSI bus operation.
4	<ol style="list-style-type: none"> 1) Reissue the original command. (Retry) 2) If the command is terminated with the same error when retried, perform recovery method 3 or 1. 3) If the command is terminated with a different error when retried, execute the recovery processing procedure for that error.

Table 5.4 Error recovery processing procedures (2 of 5)

Recovery Method	Recovery Processing Procedure
5	<ol style="list-style-type: none"> 1) After waiting about 1 second, reissue the original command (Retry). 2) If it doesn't recover after 10 retries, perform recovery method 1.
6	<ol style="list-style-type: none"> 1) Reissue the original command. (Retry) 2) If it doesn't recover after 10 retries, perform recovery method 3.
7	<ol style="list-style-type: none"> 1) Reissue the original command. (Retry) 2) If it doesn't recover after 10 retries, perform recovery method 1.
8	<ol style="list-style-type: none"> 1) If the DTE flag in the MODE SELECT parameter is "0," perform recovery method 0. 2) If the DTE flag in the MODE SELECT parameter is "1," execute one of the following according to the content indicated by the sense data. <ul style="list-style-type: none"> • If the "Valid" bit is "1," and if the address of the final data block in the data block group in the area specified in the command is indicated in the information field, perform recovery method 0. • If the "Valid" bit is "0," or even if the "Valid" bit is "1," but the address of a data block which is not that of the final data group in the area specified in the command is indicated in the information field, reissue the original command. 3) If this error (Other than a positioning error [15-xx]) occurs repeatedly in the same data block, implement alternate block allocation processing (shown in Section 6.4).
9	<ol style="list-style-type: none"> 1) Issue the MODE SENSE command and when a RECOVERED ERROR is reported, read the "Current" value in the changed MODE SELECT or MODE SELECT EXTENDED parameter. 2) If the value actually set in that parameter page is within the INIT's permissible range, perform recovery method 0. 3) If the value actually set in that parameter page is not within the INIT's permissible range, adjust the value specified in the parameter and issue the MODE SELECT or MODE SELECT EXTENDED command again.
10	<ol style="list-style-type: none"> 1) Issue the START instruction using the START/STOP UNIT command ("Immed" = 0). 2) When the START/STOP UNIT command is terminated abnormally, perform recovery method 1. 3) When the START/STOP UNIT command is terminated normally, reissue the original command (Retry).
11	<ol style="list-style-type: none"> 1) Wait for formatting (FORMAT UNIT command) to be completed. 2) Reissue the original command (Retry).

Table 5.4 Error recovery processing procedures (3 of 5)

Recovery method	Recovery processing procedure
12	<ol style="list-style-type: none"> 1) Set the "Number of Retries" value in the MODE SELECT parameters at the "Default" value. 2) Reissue the original command (Retry). (Note) 3) If the error is not recovered from after the first retry, issue the REZERO UNIT command. 4) Reissue the original command (Retry). (Note) 5) If the error is not recovered from, perform one of the following. <ul style="list-style-type: none"> • When the sense key is "HARDWARE ERROR [=4]," perform recovery method 1. • When the sense key is "MEDIUM ERROR [=3]," implement alternate block allocation processing (shown in Section 6.4). <p>Note When the original command is the REASSIGN BLOCKS command, it may be necessary to reconfigure the defect list. For details, see the description of the REASSIGN BLOCKS command (Section 3.3.2).</p>
13	<ol style="list-style-type: none"> 1) Generate the RESET condition or issue a BUS DEVICE RESET message for the IDD that reported this error. 2) After waiting 2 seconds or longer, reissue the original command (Retry), and if the spindle motor's start mode is set on "Start by Command," issue the START instruction by the START/STOP UNIT command ("Immed" = 0) before retrying. 3) If the retry procedure () does not terminate normally, perform recovery method 1.
14	<ol style="list-style-type: none"> 1) The MODE SELECT parameter is initialized at the "Save" value (if the "Save" value does not exist, the "Default" value), so when it is necessary to set the inherent parameter, issued the MODE SELECT command. 2) Reissue the original command (Retry).
15	<ol style="list-style-type: none"> 1) When not linked from the SET LIMITS command, the cause of this error occurring is that write operations at the setting terminal are prohibited, so cancel release that and issue the original command. If it is impossible to release the write protected switch at the system, perform recovery method 2. 2) When linked from the SET LIMITS command, perform recovery method 2.
16	<ol style="list-style-type: none"> 1) Issue the LOG SENSE command and read the "Current" values in the LOG SELECT parameters. 2) If the parameters' values are appropriate, reissue the original command. <p>Note This error could also be caused by a UNIT ATTENTION condition being generated, caused by a programming error of another INIT, so when the value in the parameter read in (is illegal, recovery method 2 should be performed, or the operations of the other INITs should be confirmed.</p>
17	<p>If the PRIORITY RESERVE command issued by another INIT is proper in the system, perform the necessary recovery processing in the system. If not, perform recovery method 2.</p>

Table 5.4 Error recovery processing procedures (4 of 5)

Recovery method	Recovery processing procedure
18	<ol style="list-style-type: none"> 1) Issue the MODE SENSE or MODE SENSE EXTENDED command and confirm the values of the disk media data format related parameters (Block descriptor, Page 3: Format parameters, Page 4: Drive parameters). 2) If the parameter values are correct, issue the FORMAT UNIT command and initialize the entire disk media surface. (Note) 3) If the parameter values are not correct, issue a MODE SELECT or MODE SELECT EXTENDED command and reset the necessary parameters, then reinitialize the entire disk media surface by the FORMAT UNIT command. (Note) <p>Note In a system where multiple INITs are connected together, an error may have been reported due to a MODE SELECT or MODE SELECT EXTENDED command, or a FORMAT UNIT command issued by another INIT, so before executing this recovery method, it is necessary to confirm the operations of the other INITs.</p>
19	Initialize the entire disk media surface. It is desirable at this time to increase the number of spare sectors as much as possible. If this error occurs repeatedly, it is necessary to perform alternate block allocation processing through the system (shown in Chapter 6) or reconfirm the use conditions of the disk drive, such as the installation environment.
20	<ol style="list-style-type: none"> 1) Reissue the original command (Retry). 2) If it doesn't recover after 10 retries, perform recovery method 13.
21	<ol style="list-style-type: none"> 1) Issue the MODE SENSE or MODE SENSE EXTENDED command and read the "Current" values in the MODE SELECT parameters. 2) If the parameters' values are appropriate, reissue the original command. <p>Note This error could also be caused by a UNIT ATTENTION condition being generated, caused by a programming error of another INIT, so when the values in the parameters read in (are illegal, recovery method 2 should be performed, or the operations of the other INITs should be confirmed.</p>
22	Reissue the original command (Retry).
23	<ol style="list-style-type: none"> 1) If it is necessary to reestablish rotational synchronization, issue the MODE SELECT or MODE SELECT EXTENDED command (specify by Page 4, byte 17). 2) Reissue the original command (Retry).
24	<ol style="list-style-type: none"> 1) Issue the READ or READ EXTENDED command and read the data for the block where the error occurred. 2) Investigate the cause of the data not matching and perform data recovery processing from the INIT.
25	Reissue the original command (Retry). It is desirable at this time to confirm the operations of the other INITs.

Table 5.4 Error recovery processing procedures (5 of 5)

Recovery method	Recovery processing procedure
26	<ol style="list-style-type: none"> 1) Issue the LOG SENSE command and read the "Current" values of the LOG SELECT parameters. 2) Search for any parameter values which exceed the threshold value or have reached the maximum value, then issue the LOG SELECT command from the INIT and perform resetting. 3) Reissue the original command.
27	<ol style="list-style-type: none"> 1) Issue the INQUIRY command and read the operation mode information. 2) If the parameter values are appropriate, reissue the original command. <p>Note This error could also be caused by a UNIT ATTENTION condition being generated, caused by a programming error of another INIT, so when the values in the parameters read in (are illegal, recovery method 2 should be performed, or the operations of the other INITs should be confirmed.</p>

5.2.3 Error logging

In order to collect information that is effective in maintenance, it is desirable for the INIT to accumulate (log) error information related to the SCSI bus which it has detected itself (BUS FREE error, command completion wait time-out, etc.) and error information reported by the IDD.

By specifying "1" in the PER bit in the "Read/Write Error Recovery parameter (Page 1) and the "Verify Error Recovery parameter (Page 7) of the MODE SELECT or MODE SELECT EXTENDED command, the INIT can know of the occurrence of errors which were recovered from successfully by the IDD's internal error recovery processing and their contents. By logging that error information, the INIT can obtain data for more detailed analysis of the disk drive's operating condition.

Concerning the contents of the error log, it is recommended that the data have a time stamp affixed so that they can be edited in a time series of the times the errors were detected, and that they include the following information.

- The source which issued the command and the SCSI ID of the SCSI device which was the target of the command.
- The CDB which was issued.
- The receiving status, or, when the status was that the command could not be received, the code showing the type of error detected by the INIT and its content.
- All bytes reported by the IDD.

5.3 Disk Drive Error Recovery Processing

This section explains concerning error recovery processing methods and procedures executed by the IDD for each type of disk drive related error. The INIT can control the error recovery processing methods executed by the IDD using the MODE SELECT parameters.

5.3.1 Error states and retry processing procedures

(1) Seek error

Mechanical malfunctions of the disk drive during a seek operation and failure of serial addresses detected during verification of the ID area to match are included in this error.

When a seek error occurs, the IDD first executes rezero seek, then tries repositioning at the target cylinder and restarts the original processing. If the error is not recovered from, retry processing (rezero seek and repositioning) is performed up to the number of times specified in "Number of Retries during Seek Error" in the MODE SELECT parameters.

If the error cannot be recovered from even when retry processing is executed the specified number of times, the IDD terminates the command which is currently being executed with a CHECK CONDITION status. The sense key in the sense data at this time is "HARDWARE ERROR [=4]" and the additional sense code indicates "Mechanical positioning error [=15-01]" or "Positioning error detected by read of medium [=15-02]."

(2) Read error in uncorrectable data

This error is a failure to detect the Sync Byte pattern during reading of data or an ECC error for which correction processing is impossible. If this error is detected, the IDD, after waiting one revolution of the disk media, tries reading again. When the error is not recovered from, reading is retried repeatedly the number of times specified in the MODE SELECT parameter ("Number of Retries during Read" or "Number of Retries during Write").

In cases where correction is possible during execution of retry processing, the processing procedure is according to "Correctable Data Read Error" in item (3). If errors cannot be recovered from even after retry is executed the specified number of times, the IDD terminates the command that is currently being executed with a CHECK CONDITION status. The sense key in the sense data at this time is "MEDIUM ERROR [=3]" and the additional sense code indicates "Sync byte not found for data field [=13-00]" or "Unrecovered read error [=11-01]."

In this error retry processing, rereading accompanied by head offset processing is performed.

(3) Correctable data read error

This error is a correctable ECC error when data are being read. Processing methods when this error is detected differ depending on the values specified in the EER flag and DCR flag in the MODE SELECT parameters.

If immediate correction of errors is permitted (DCR = 0, EER = 1), the IDD immediately makes error corrections in the data buffer and sends the corrected data to the INIT. Also, in the case of Verify processing, at the point when it judges that correction is possible, it regards verification as being successful and continues processing of subsequent data blocks.

If error correction is permitted but immediate correction is not permitted (DCR = 0, EER = 0), reading of data as in item (2) is retried up to the number of times specified in the other MODE SELECT parameters ("Number of Retries during Read" or "Number of Retries during Write").

If error correction is prohibited (DCR = 1, EER = 0), reading of data as in item (2) is retried up to the number of times specified in "Number of Retries during Read" or "Number of Retries during Write."

If the error cannot be recovered from even when this retry processing is executed, the IDD terminates the command that is currently being executed with a CHECK CONDITION status. The sense key in the sense data at this time is "MEDIUM ERROR [=3]" and the additional sense code indicates "Unrecovered read error [=11-00]."

(4) Other internal IDD errors

If an irrecoverable error other than those in items (1) to (3) above is detected internally in the IDD, the IDD terminates the command that is currently being executed with a CHECK CONDITION status. The sense key in the sense data at this time is "HARDWARE ERROR [=4]."

5.3.2 Auto alternate block allocation processing

The IDD is equipped with a function which automatically executes alternate block allocation processing for defective data blocks detected during execution of the READ and READ EXTENDED commands.

(1) Auto alternate block allocation processing during a read operation

This function is enabled by specifying "1" in the ARRE flag in the MODE SELECT parameters. Furthermore, this function is applicable to the following commands only.

- READ command
- READ EXTENDED command

When this function is permitted, if, during read processing to the data area, an error which is an object of retry processing is detected, and which it is impossible to recover from even when reading is retried (see Section 5.3.1 (2)) the number of times specified in the "Number of Retries during Read" field in the MODE SELECT parameters, the IDD allocates an alternate block for that data block and executes copying of the alternate block to the data area. Alternate block allocation processing is the same as processing with the REASSIGN BLOCKS command. Furthermore, recovered data copied to the alternate block are data which are read out, skipping the ID area, if there is an ID area, or they are data which have been corrected through the ECC.

This function is applied twice only during execution of one command. Alternate block allocation processing and copying are executed for the first and second defective data block to be detected during execution of a command, but if a third defective data block is detected, the command that is being executed at that point is terminated with an error. However, by the INIT's reissuing the same command, auto alternate block allocation is applied sequentially and error recovery can be attempted.

Remark:

1. When this function is specified (ARRE = "1"), the EER flag's specification in the MODE SELECT parameter is made invalid and Read retry processing is performed up to the number of times specified in the "Number of Retries during Read" parameter. If "0" is specified in the DCR flag, correction processing of the data is performed afterward (see Section 5.3.1 (3)). When "1" is specified in the DCR flag, ECC correction processing is prohibited, so even if "1" is specified in the ARRE flag, auto alternate block allocation processing will not be executed for errors in the data area.
2. When errors in the data area are recovered from by ECC correction processing, before implementing alternate block allocation processing, rewriting of the recovered data and a verify check (rereading) are performed. If data are recovered by rewriting, alternate block allocation of that data block is not performed.
3. When a write operation is prohibited through the setting terminal, the auto alternate block allocation processing specification is disabled.

(2) Auto alternate block allocation processing during a write operation 1

This function is enabled by specifying "1" in the AWRE flag in the MODE SELECT parameters. Furthermore, this function is applicable to the following commands only.

- WRITE command
- WRITE EXTENDED command
- WRITE AND VERIFY

If a WRITE command has the same LBA in the log, then data will be written to the sector, and it will be verified. If the verify is successful, then the AWRE will not be performed. (no sense will be reported).

If the verify is unsuccessful, then check the spare. Write the data onto the new spare, and verify it. If the verify is successful, then the reallocation will be proceeded. If the verify is unsuccessful, then the drive will add the defective spare onto the G-List, and then its conversion process will be interrupted. After reallocates all of the logged LBA included in a WRITE command the drive will start the write operation.

(3) Auto alternate block allocation processing during a write operation 2

This function is enabled by specifying "1" in the AWRE flag in the MODE SELECT parameters. Furthermore, this function is applicable to the following commands only.

- WRITE command
- WRITE EXTENDED command
- WRITE AND VERIFY

When this function is permitted, if, during WRITE/WRITE EXTENDED command detects any Servo error (e.g. Write offtrack error) and cannot be recovered within pre-determined retry number (specified in Mode Parameter). For the sectors around defective Servo, alternate blocks are allocated and the data of this WRITE commands are re-written.

Sectors to be made AWRE shall be following:

- the sector where the error occurs and the latter sectors and,
- the sectors whose data are logically continual and stored in Cache,
- the sectors which will be processed in this Write command and,
- the sectors which locate between erroneous Servo -1 and +1 (including Split sector)

This function is also applied for the sector which has already been re-assigned.

Remark:

1. When a write protection is prohibited through the setting terminal, the auto alternate block allocation processing specification is disabled.

5.3.3 Error recovery processing control

The INIT can, by specifying the MODE SELECT parameters, can control the error recovery processing (retries) of the IDD with respect to each type of error related to the disk drive.

Table 5.5 shows the types of error and the method of specifying the number of retries for those errors. for those items where the INIT can specify the number of retries, normally, it is recommended that the default value or a greater number of times be specified. If a value smaller than the default value is specified, and commands are terminated abnormally without error recovery processing succeeding, the INIT should reset the corresponding MODE SELECT parameters at the default value, then reexecute the original commands.

The MODE SELECT parameters related to disk drive error recovery processing which the INIT can specify are shown below. See the description of the MODE SELECT command (Section 3.1.5) concerning details of the functions of each parameter. The INIT can issue the MODE SELECT or MODE SELECT EXTENDED command as necessary and select the error recovery flags and the number of retries.

a. Read/Write Error Recovery Parameters (Page Code = 1)

- AWRE (automatic write reallocation enabled)
- ARRE (automatic read reallocation enabled)
- TB (transfer block)
- EER (enable early recovery)
- PER (post error)
- DTE (disable transfer on error)
- DCR (disable correction)
- Number of retries during read (See Table 5.5)
- Number of retries during write (See Table 5.5)

- b. Verify Error Recovery Parameters (Page Code = 7)
- EER (enable early recovery)
 - PER (post error)
 - DTE (disable transfer on error)
 - DCR (disable correction)
 - Number of retries during verify (See Table 5.5)
- c. Additional Error Recovery Parameters (Page Code = 21)
- Number of retries during seek error (See Table 5.5)

Table 5.5 Disk drive errors and number of retries

Item	Type of Error	Number of Tries Specification [Default value]
1	Seek Error	Number of Retries during a Seek Error [15]
2	Data field Read Error of Data field	Number of Retries during Read or [63] Number of Retries during Verify
3	Data field Write Error	Number of Retries during Write [63]

Remark:

The number of retries is calculated single logical sector processing units, except in the following cases.

- The number of retries is calculated as individual retries.
- In processing of data blocks for which alternate sector processing is completed, the number of retries on the defective sectors is calculated separately from the number of retries on the alternate sectors.

This page is intentionally left blank.

CHAPTER 6 Disk Media Management

- 6.1 Defect Management**
- 6.2 Disk Media Initialization**
- 6.3 Data Block Verification Methods (Recommended)**
- 6.4 Alternate Block Allocation Processing**

In this chapter, disk media defect management methods, treatment methods for media defects which occur during operation, reinitialization procedures and other disk media management methods are discussed. Furthermore, see Chapter 3, "Data Format" in the "Product Manual" concerning details of the data recording format on the disk media.

6.1 Defect Management

(1) Defect lists

Information on the positions of defects in the disk media are managed by the types of defect list shown below. See the description of the FORMAT UNIT command (Section 3.3.1) concerning methods for using the defect lists.

- **P List** Defect position information at the point when the disk drive was shipped from the factory is recorded in this list. The defective portions included in this list are permanent defects, and when the disk media is initialized, it is necessary that this list be used and alternate block processing be executed.
- **D List** This list includes defect position information specified by the INIT in the FORMAT UNIT command when initializing the disk media.
- **C List** This list contains information on the positions of defective blocks detected during the data block Verify operation (Certification) after initialization by the FORMAT UNIT command. This information is generated internally by the IDD when the FORMAT UNIT command is executed.
- **G List** This list is composed from the defective logical data block position information specified by the INIT in the REASSIGN BLOCKS command, defective logical data block position information from alternate blocks which have been allocated by the IDD's auto alternate block allocation processing, information specified as the D List and information generated as the C List.

The P List and G List are recorded in the system space on the disk media. The INIT can read the contents of these lists by the READ DEFECT DATA command.

(2) Alternate block allocation

Alternate data blocks are allocated in defective sector units for defective data blocks (= sectors) on the disk media by the IDD's internal defect management methods.

a. Spare sector area

Spare sectors for allocation as alternate blocks are secured in both of the following areas or alternate cell. When the INIT initializes the disk media, it can specify the spare sector area to be prepared on the disk drive and the size of that area. For details, see the description in Section 3.1.2 "Spare Area for Alternates" in the "Product Manual."

- **Spare sectors within a cell**

Spare sectors are secured in the final track of each cell. They are used as alternate blocks for defective sectors within the same cell.

- **Alternate cells**

This is an exclusive cell for allocation of alternate blocks. Alternate cells are secured only in the specified quantity in order from the topmost cylinder. Spare sectors in an alternate cell are used only in the case that the spare sectors within each cell are used up and alternate block allocation is not possible within the same cell.

b. Alternate block allocation methods

Alternate block allocation processing is performed using one of the following methods.

- **Sector slip processing**

This is a method of skipping defective sectors and writing the logical data blocks corresponding to those sectors in order in physically consecutive sectors. Sector slip processing is performed only within the same cell as the defective sectors and until all the spare sectors within that cell are used up.

- **Alternate sector processing**

This is a method of allocating logical data blocks corresponding to defective sectors to unused spare sectors in an alternate cell.

c. Alternate block allocation processing

Alternate block allocation processing is implemented by the FORMAT UNIT command, REASSIGN BLOCKS command or "Auto Alternate Block Allocation Processing." In sector slip processing, the defective sectors are excluded and logical data blocks are located in physically consecutive sectors, but when alternate block processing is performed, the affected logical data blocks are located in spare sectors which are not physically consecutive with the previous and following logical data blocks which are physically located on the disk. For details, see the description in Section 3.3.2 "Alternate Block Allocation" in the "Product Manual."

- **Alternate block allocation processing during FORMAT UNIT command execution**

With the FORMAT UNIT command, alternate block allocation is done by sector slip processing until all the spare sectors within the same cell have been used up for defective sectors included in the type of defect list (P, G or D) specified in the command. When all the spare sectors in the same cell have been used up, subsequent defective sectors in that cell are treated by allocating spare sectors in an alternate cell by alternate sector processing.

After implementing this alternate block allocation and initializing the disk media, at times when a data block Verify (Certification) operation is not prohibited, the IDD, reads all the initialized data blocks and verifies their normalcy. If a defective data block is detected during this processing, the IDD generates the C List as defect position information and allocates alternate blocks by alternate sector processing for those defective data blocks. In this case, alternate blocks are allocated in spare sectors in an alternate cell.

- **Alternate block allocation processing by the REASSIGN BLOCKS command**

With the REASSIGN BLOCKS command, alternate block allocation is performed by alternate sector processing for defective logical data blocks specified by the INIT. In this case, alternate blocks are allocated in spare sectors in an alternate cell.

- **Auto alternate block allocation processing**

If auto alternate block allocation processing is permitted by the AWRE flag or the ARRE flag of the MODE SELECT parameters, the IDD executes alternate block allocation automatically by alternate sector processing for defective data blocks detected during execution of the WRITE, WRITE EXTENDED, WRITE AND VERIFY, READ and READ EXTENDED commands. The alternate block allocation method in this case is the same as in the case of the REASSIGN BLOCKS command. See the description in Section 5.3.2 concerning "Auto Alternate Block Allocation Processing".

6.2 Disk Media Initialization

6.2.1 Initialization during installation

The disk drive is initialized for the inherent (default) data format for each respective model name (model class) when it is shipped from the factory, so ordinarily, it is not necessary to initialize (format) the disk media when it is installed in a system. However, in cases where data attributes which differ from the default format are necessary, initialization (formatting) of the entire disk media by the following procedures is necessary. At this time, the INIT can change the following data format attributes.

- The logical data block length.
- The number of logical data blocks or the number of cylinders in the User Space.
- The size of the spare area for alternate blocks.

(1) Issuing the MODE SELECT command

The MODE SELECT or MODE SELECT EXTENDED command is issued and the format attributes on the disk media are specified. The necessary parameters at this time are as follows.

a. Block descriptor

The logical data block size (byte length) is specified in the "Data block length" field. Also, when desiring to clearly specify the logical data block count, specify that value in the "Data block count" field. If not, zero may be specified in the "Data block count" field. In that case, the number of logical data blocks after initialization will be determined by the values specified in the Format parameters (Page 3) and the Drive parameters (Page 4).

b. Format parameters (Page 3)

Specify the number of spare sectors secured in each cell in the "Alternate sector count/zone" field. It is desirable not to specify a value that is lower than the IDD's default value in this field.

c. Drive parameters (Page 4)

The number of cylinders in the "User Space," cannot be changed. The number of cylinders necessary to secure the number of logical data blocks specified in the "Data block count" field in the block descriptor will be allocated to the user space.

(2) Issuing the FORMAT UNIT command

Issue the FORMAT UNIT command and initialize the entire disk media surface.

In this FORMAT UNIT command, the entire disk media surface is initialized using the P List, then after initialization, the data blocks are verified. If any defective blocks are detected in the Verify operation, alternate blocks are allocated for those data blocks. Also, the defect position information for only the defective data blocks detected in the Verify operation is recorded in the G List.

The contents which need to be specified at this time are as follows.

a. CDB specification

Specify "0" in the "FmtData" bit and the "CmpLst" and "000" in the "Defect List Format" field in the CDB.

b. FORMAT parameters

If the items values in the previous item are specified in the CDB, the Format parameter is not necessary.

6.2.2 Re-initialization

The INIT can reinitialize the disk drive after it has been operated using the FORMAT UNIT command.

Note:

If it is necessary after reinitialization to restore the data that were stored on the disk media, it is necessary to save the data before executing reinitialization, then execute data restore using system software after reinitialization.

The INIT can change the size of the spare sector area and its location as well as the number of logical data blocks before reinitialization. The recommended procedure for reinitialization is shown below. However, in cases where the logical data block length is changed, the initialization procedure described in Section 6.2.1 must be followed during installation.

(1) MODE SELECT command

If the logical data block count (size of the User Space) or the size of the spare sector area and its location are changed, issue the MODE SELECT EXTENDED command and specify the disk media format attributes. The parameter specification method is the same as in the case of initialization processing during installation, described in Section 6.2.1. If the same format attributes as at present will continue to be used, it is not necessary to issue the MODE SELECT EXTENDED command.

(2) FORMAT UNIT command

Issue the FORMAT UNIT command in either of the following two formats and initialize the entire disk media surface.

- a) Specify "1" in the "FmtData" bit, "0" in the "CmpLst" bit and "000" in the "Defect List Format" field. Also, prepare only a 4-byte header, specify "0" in the "FOV," "DPRY," "DCRT" and "STPF" bits and zero in the "Defect List Length" field.
 - In this FORMAT UNIT command, the entire disk media surface is initialized using the P List and the previously existing G List, then after initialization, the data blocks are verified. If any defective blocks are detected in the Verify operation, alternate blocks are allocated for those data blocks. Also, the previously existing G List is saved, and the defect position information for the defective data blocks detected in the Verify operation is added to the G List. During initialization, alternate blocks for which sector slip processing was applied for previously known defects are reallocated, so optimization of the logical data block locations on the disk media can be expected.
- b) Specify "0" in the "FmtData" bit and in the "CmpLst" bit and "000" in the "Defect List Format" field. In this case, specification of the format parameters is not necessary.
 - In this FORMAT UNIT command, the disk media is initialized using only the P List, then after initialization, the data blocks are verified. If any defective blocks are detected in the Verify operation, alternate blocks are allocated for those data blocks. Also, the previously existing G List is erased and defect position information for the defective data blocks detected in the Verify operation is recorded in a new G List.

6.3 Data Block Verification Methods (Recommended)

The recommended procedure for verifying from the INIT the normalcy of logical data blocks located on the disk media is as shown below. It is desirable for the INIT to verify the data blocks after initialization of the disk media is completed or when executing alternate block allocation processing by the REASSIGN BLOCKS command.

Note:

The INIT must not recognize the defective data blocks included in the P List as normal data blocks in the verification operation.

After the INIT has written a specific data pattern for logical data blocks which is the object of verification using the procedure described below, it next reads those data or verifies the data blocks by executing Verify.

(1) Setting parameters by the MODE SELECT command

Issue the MODE SELECT or the MODE SELECT EXTENDED command and prohibit retry processing, data correction and operation of the Read-Ahead Cache feature. The necessary parameter settings are as shown below.

a. Read/Write Error Recovery Parameters (Page 1)

- AWRE = 0, ARRE = 0
- TB = 0 or 1
- EER = 0, PER = 1, DTE = 1, and DCR = 1
- Number of Retries during Read = Zero
- Number of Retries during Write = Zero

b. Verify Error Recovery Parameters (Page 1)

- EER = 0, PER = 1, DTE = 1, and DCR = 1
- Number of Retries during Verify = Zero

c. Caching Parameters (Page 8)

- RCD = 1

(2) Writing a data pattern

Write a data pattern for verification in the data block which is the object. The recommended data pattern at this time is X '0123456789ABCDEF' repeated. The WRITE, WRITE EXTENDED or WRITE SAME command can be used to write data.

(3) Reading and verification of data

Issue the READ, READ EXTENDED or VERIFY command and verify that the data written to the disk media in item (2) were read correctly.

To verify reading of data, it is recommended that reading of the same data block be done at least 2 times, but the number of times verification is performed is determined by the conditions on the system. If reading of all data is completed normally, it can be recognized that use of that data block can be used normally.

(4) Error verification

When an error related to the disk media (Sense Key = 3: MEDIUM ERROR) occurs during writing of the data pattern (see item (2)) or verification of data reading (see item (3)), reexecute the rewriting and reading verification combination (two times) at least 8 times.

When the same type of error occurs even once during reexecution, it is recommended that the INIT treat that data block as a defective block. If the reexecution of verification is completed normally every time, it should be regarded that that data block can be used normally.

6.4 Alternate Block Allocation Processing

If errors on the disk media which cannot be recovered from are detected, or if a recoverable error occurs repeatedly in the same data block, it is necessary for the INIT to allocate an alternate block for the data block where the error occurred using the REASSIGN BLOCKS command. The procedure for alternate block processing is shown below.

Note:

An attempt will be made to copy the contents of the data area of the logical data block specified in the "Defect Data" list to the alternate block allocated by this command, but in some cases, the data cannot be copied. Confirmation of the contents of data in the allocated alternate block, saving of data before issuing this command and restoring of data after executing this command are the responsibility of the INIT.

- 1) Verify data blocks in accordance with the procedure in Section 6.3 for data blocks where error occur. When such a data block is judged to be normal, alternate block allocation need not be implemented. In this case, rewrite the original data to that data block if necessary. When the data block is judged to be defective, implement the processing in item 2) and after.
- 2) Specify a logical block address for a data block which is judged to be defective and issue the REASSIGN BLOCKS command.
- 3) If the REASSIGN BLOCKS command is terminated normally, verify that logical data block according to the procedure in Section 6.3. If that data block is judged to be correct, allocate an alternate block and terminate processing. When the data block is judged to be defective, return to 2) and issue the REASSIGN BLOCKS command again, then try reallocating another alternate block for that logical data block.

The alternate block allocation history (defect position information) is registered as an addition to the defect list (G List). Therefore, when reinitializing the hard disk with the FORMAT UNIT command (see Section 6.2.2), if use of the G List is specified, defect processing can be performed which reflects the operation results up to that time. Also, since "Alternate sector processing" is applied in alternate block allocation in the REASSIGN BLOCKS command, the physical connectivity of the logical data block positions on the disk media is destroyed, but by reinitializing the disk, as long as the number of defective sectors in the cell does not exceed the number of spare sectors per cell, the logical data blocks are relocated by sector slip processing so that their physical connectivity is maintained.

Glossary

Additional Sense Code

This is a 1-byte code displayed in the sense data and is information which specifies the type of error that was detected.

Axial acceleration

Acceleration in the recording layer along the line perpendicular to the disk reference surface at a specified rotation speed. Axial acceleration is detected by optical means.

Bus Condition

This is an asynchronous condition for changing the status transition on the SCSI bus. There are two types, the ATTENTION condition and the RESET condition.

Bus Phase

This is the name given to the SCSI bus state. The SCSI bus is in one state or another, the BUS FREE phase, the ARBITRATION phase, the SELECT phase, the RESELECTION phase or the INFORMATION TRANSFER phase. In addition, the INFORMATION TRANSFER phase is subdivided into the DATA IN, DATA OUT, COMMAND, STATUS, MESSAGE AND MESSAGE OUT phases in accordance with the type of information being transferred in the INFORMATION TRANSFER phase.

CCS

Common Command Set

This is the standard form of SCSI logical specifications stipulated by the operations subcommittee of the American National Standards Institute (ANSI) which stipulates functions which a direct access device (magnetic disk, etc.) should support.

CDB

Command Descriptor Block

A series of data which describes commands related to input/output operations, sent from the initiator to the target.

Command

This is a command to a target to perform an input/output operation, and it is described as the CDB.

Disconnect

This is processing which temporarily frees the connected state of the target with the SCSI bus and the initiator at the point in the target's command processing execution process when operations on the SCSI bus are not needed.

Initiator (INIT)

This is a SCSI device which initiates input and output operations on the SCSI bus. In this manual, initiator has been abbreviated to "INIT."

Logical Unit

This is the device unit which is the object of input/output operations on the SCSI bus.

LUN

Logical Unit Number

This is the serial number which identifies a logical unit.

Message

This is control information that is delivered and received between the initiators and targets operating on the SCSI bus for controlling a series of bus phases and input/output operation execution sequences.

Reconnect

For a target which has executed disconnect processing, this is processing which reconnects to the initiator at the point when operations on the SCSI bus again become necessary.

SCSI

Small Computer System Interface

The standardized input/output interface of the American National Standards Institute (ANSI). [Standard No.: ANSI X3. 131-1986]

SCSI Device

The general name given to a device which is connected to the SCSI bus (input/output device, I/O controller, host adapter, etc.).

SCSI ID

On the SCSI bus, this is the physical serial number which identifies a SCSI device. This is a unique value for each SCSI device and the ID can be assigned from #0~#7 to correspond to the bit number of the SCSI data bus.

Sense Data

When several items of error information are included in a command's completion status, this is information generated by the target for reporting detailed information on that status.

Sense Key

This is a 4-bit code displayed in the sense data. It contains information for classifying the type of error that was detected.

Status

This is 1 byte of information reported to the initiator by the target device when execution of each command is completed, which displays the command's completion state.

Target (TARG)

This is the SCSI device that executes the input/output operations initiated by the initiator (INIT). In this manual, target is abbreviated "TARG."

This page is intentionally left blank.

Acronyms and Abbreviations

A		L	
ACK	Acknowledge	LSB	Least significant byte
ATN	Attention	LUN	Logical unit number
AWG	American Wire Gauge		
B		M	
BSY	Busy	MSB	Most significant byte
		MSG	Message
C		O	
C/D	Control/data	OEM	Original equipment manufacturer
CCS	Common command set		
CDB	Common descriptor block		
D		R	
DB	Data bus	REQ	Request
DBP	Data Bus Parity	RST	Reset
DC	Direct current		
E		S	
EIA	Engineering Industries Association	SCSI	Small Computer System Interface
		SDTR	Synchronous data transfer request
		SEL	Select
G		T	
GND	Ground	TARG	TARGet
		TRM	Terminator
I			
I/O	Input/output		
ID	Identifier		
IDD	Intelligent disk drive		
INIT	Initiator		
ISO	International Organization for Standardization		

This page is intentionally left blank.

Index

I	B
10-byte cdb basic format.....	1-2
12-byte cdb basic format.....	1-2
6-byte cdb basic format.....	1-1
A	
accounting date	4-64
ACE.....	3-18
active notch	4-32
additional data length	3-5
additional error recovery parameter	4-48, 5-27
additional sense code.....	5-4, 5-6, 5-7, 5-8, 5-9, 5-10, 5-11
additional sense code qualifier	5-4, 5-6, 5-7, 5-8, 5-9, 5-10, 5-11
additional sense data	
length	5-3
AGD	3-18
AIP	
checking enabled	3-18
generation disabled.....	3-18
alternate area	1-32
alternate block allocation	6-2
method.....	6-2
processing	6-2, 6-7
processing by the REASSIGN BLOCKS	
command.....	6-3
processing during FORMAT UNIT	
command execution	6-3
alternate sector	
count/zone	4-15
processing	6-2
alternate track	
count / drive.....	4-15
count / zone	4-15
analysis of the termination status	5-13
application client page.....	4-66
ARRE.....	4-3
auto alternate block allocation processing	5-24, 6-3
during a read operation.....	5-24
during a write operation.....	5-25
automatic read reallocation enable	4-3
automatic write reallocation enabled.....	4-3
AWRE.....	4-3
B	
background control mode parameter	4-47
background medium scan page.....	4-69
background medium scan parameter	4-70
background medium scan status parameter	4-69
basic disconnect processing procedure	1-13
bit 6	1-5
bit 7	1-5
block descriptor.....	3-24, 3-36, 6-4
length.....	3-24, 3-36
buffer data	3-111, 3-116
buffer descriptor.....	3-117
buffer empty ratio	2-6, 4-11
buffer full ratio.....	2-5, 4-11
buffer overrun/underrun page	4-50
BUS FREE error	5-14
bus inactivity limit	4-12
BUSY status.....	1-7
BUSY/TASK SET FULL status	5-13
byte 2	3-23, 3-53
byte 20	4-16
byte distance from index format	3-86, 3-87
bytes	
0 to 2.....	3-16
10, 11.....	4-15
12 to 19.....	4-16
2 to 9.....	4-15
6 to 16.....	4-19
C	
C list.....	3-82, 6-1, 6-3
cache control parameter	2-9
cache segment count	4-26
caching	
object command	2-7
operation.....	2-6
parameter.....	2-9, 4-21, 4-22, 6-6
caution in specifying D list	3-88
CDB	
operation code	5-12
size.....	3-10
specification	6-4
usage data	3-10
CHANGE DEFINITION	3-14
changed by another INIT	1-20

- changed operating definition1-20
 - CHECK CONDITION status1-7
 - clocking field.....3-8
 - CmdDt.....3-3
 - code
 - 00004-51
 - 00014-52
 - 00024-52
 - 00034-53
 - 00064-54
 - command
 - can be executed even in not ready state.....1-25
 - cleared by another INIT.....1-20
 - code.....1-3
 - completion wait time-out.....5-14
 - format1-1
 - inherent information5-3
 - link.....1-9
 - other than INQUIRY command.....1-20
 - other than REQUEST SENSE command ...1-20
 - queuing function.....1-16
 - specification.....3-1
 - support data3-9
 - supported data.....3-3
 - command processing1-1
 - exception.....1-23
 - in not ready state.....1-24
 - command support data3-9
 - COMMAND TERMINATED status.....1-8
 - condition for permitting disconnect1-11
 - CONDITION MET status1-7
 - connect time limit.....4-12
 - control3-1
 - control byte.....1-5
 - control mode parameter.....4-27
 - correctable bit length.....4-5, 4-21
 - correctable data read error.....5-23
 - count basis.....4-50
 - cylinder count.....4-19
 - cylinder skew factor4-16
- D**
- D list.....3-82, 3-86
 - data access command3-71
 - data block
 - addressing1-30
 - count3-24
 - length3-24
 - verification method.....6-6
 - data block count3-36
 - data block length3-37
 - data buffer2-1
 - configuration.....2-2
 - configuration and basic operation.....2-1
 - management2-1
 - data byte length/physical sector4-16
 - data defect list3-82
 - data only, with address
 - specification3-112, 3-117
 - data overrun4-51
 - data space configuration.....1-31
 - data strobe offset count4-5
 - data transfer disconnect control4-12
 - data underrun4-51
 - data which is object of caching2-7
 - date of manufacture.....4-64
 - DCR4-4, 4-20
 - DCRT.....3-85
 - default value.....3-85
 - defect data
 - configuration3-95, 3-99
 - list configuration.....3-92
 - defect descriptor.....3-86, 3-87, 3-88
 - list3-96
 - defect list.....3-82, 3-86, 6-1
 - format3-96
 - length.....3-86, 3-96
 - defect management6-1
 - defect processing during initialization3-89
 - definition of data space1-30
 - demand read retention priority4-24
 - detailed information5-12
 - device serial No.....3-11
 - device serial number field.....3-8
 - device type code.....3-5
 - Device Type Code.....3-9
 - DImm4-13
 - disable
 - save.....3-53
 - update3-53
 - disable certification3-85
 - disable correction4-4, 4-20
 - disable primary.....3-85
 - disable queuing4-29
 - disable read-ahead.....4-25
 - disable transfer on error4-4
 - disabling caching data.....2-7
 - DISC4-24
 - disconnect immediate.....4-13
 - disconnect processing
 - exception1-14
 - procedure after command phase
 - execution.....1-13
 - procedure after data transfer execution1-13
 - disconnect time limit4-12
 - disconnect/reconnect parameter.....4-10
 - disconnect/reconnect processing.....1-11
 - disconnecting after the final data transfer is
 - completed1-13

disconnecting during a data transfer 1-13
 discontinuity 4-24
 disk drive error
 and number of retry 5-27
 recovery processing 5-23
 disk media
 initialization 6-3
 management 6-1
 DPOFUA bit 3-36
 DPRY 3-85
 DQue 4-29
 DRA 4-25
 drive parameter 4-18, 6-4
 driver asymmetry 4-37
 driver precompensation 4-36
 driver slew rate 4-37
 driver strength 4-36
 DS 3-53
 DTDC 4-12
 DTE 4-4
 DU 3-53

E

echo buffer 3-114, 3-118
 descriptor 3-118
 echo buffer descriptor 3-118
 EER 4-3
 effective for 16-bit SCSI device only 3-16
 element scope 3-60
 EMDP 4-13
 enable early recovery 4-3
 enable modify data pointer 4-13
 enable threshold comparison 3-53
 enable vital product data 3-3
 ending boundary 4-33
 error code 5-3
 error logging 5-22
 error recovery
 control flag during self-diagnosis test 3-101
 flag 4-20
 error recovery flag, combination of 4-7, 4-8, 4-9
 error recovery processing 1-26
 control 5-26
 procedure 5-18, 5-19, 5-20, 5-21, 5-22
 error state and retry processing procedure 5-23
 error verification 6-7
 ETC 3-53
 EVPD 3-3
 example of data buffer operation
 during read 2-3
 during write 2-4
 expanded sense data format 5-2
 extended self-test completion time 4-30

F

fair arbitration 4-13
 fatal hardware error 1-29
 force sequential write 4-26
 force unit access 3-72
 format command 3-81
 format option valid 3-85
 format parameter 3-84, 4-14, 6-4
 FORMAT parameter 6-4
 FORMAT UNIT 3-81
 command 6-5
 command defect processing 3-89, 3-90, 3-91
 command parameter list configuration 3-84
 FOV 3-85
 FSW 4-26
 FUA 3-72
 FUA (force unit access) 3-74

G

G list 3-82, 6-1
 bit 3-96
 general response in not ready state 1-25
 general usage application client parameter
 data 4-66
 generation of UNIT ATTENTION
 condition 1-19
 global logging target save disable 4-28
 GLTSD 4-28
 GOOD status 1-6
 group code 1-3
 grown defect list 3-82
 grown list 3-96

H

hard sectoring 4-17
 head offset count 4-5
 header 3-16, 3-23, 3-36, 3-85, 3-95
 header + data
 with address specification 3-112, 3-116
 without address specification 3-111, 3-115
 HSEC 4-17

I

IC 4-24
 IDD SCSI ID 5-12
 ILI 5-3
 illegal CDB, handling 1-5
 illegal LUN specification 1-24
 immed 3-86
 immediate 3-86
 incorrect length indicator 5-3
 information 5-3
 information unit supported 3-8

informational exception control4-43
 informational exceptions control page4-43
 INIT error recovery method5-12
 initialization during installation.....6-3
 initiator control enable4-24
 INQUIRY3-2
 command1-21
 interleave factor.....4-16
 INTERMEDIATE CONDITION MET
 status1-8
 INTERMEDIATE status1-7
 issuing MODE SELECT command.....6-4
 issuing the FORMAT UNIT command.....6-4
 IUS bit3-8

L

LBCSS.....4-26
 LBIN3-53
 link1-5
 list parameter3-53
 log parameter.....4-49
 LOG SELECT3-50
 LOG SELECT command
 log parameter3-52
 LOG SENSE3-54
 LOG, SELECT command
 parameter list3-51
 logical block
 address1-3
 addressing1-32
 cache segment size.....4-26
 logical or physical notch4-32
 logical unit
 number1-3
 reserve function3-43
 scope3-60
 Self-Test.....3-105
 logical/physical address conversion ... 3-104, 3-108
 look-ahead
 operation2-10
 volume2-10
 look-ahead cache feature.....2-6
 LP3-53
 LPN4-32
 LUN.....1-3

M

maintenance, diagnostic command.....3-99
 maximum burst size4-12
 maximum number of notch4-32
 maximum pre-fetch4-25
 control block count4-25
 media type 3-23, 3-36
 microcode.....3-112

microcode download
 with offset, with saving3-114
 with offsets, without saving.....3-113
 with saving3-113
 minimum pre-fetch.....4-25
 mode = 0, 0, 0, 03-111, 3-115
 mode = 0, 0, 0, 13-112, 3-116
 mode = 0, 0, 1, 03-112, 3-117
 mode = 0, 0, 1, 13-117
 mode = 0, 1, 0, 03-112
 mode = 0, 1, 0, 13-113
 mode = 0, 1, 1, 03-113
 mode = 0, 1, 1, 13-114
 mode = 1, 0, 1, 03-114, 3-118
 mode = 1, 0, 1, 13-118
 mode parameter.....4-1
 mode parameter changed1-20
 MODE SELECT3-19
 command6-5
 MODE SELECT command.....3-23
 MODE SELECT EXTENDED3-27
 MODE SELECT EXTENDED command
 parameter configuration3-29
 MODE SELECT parameter 2-5, 4-2, 4-10,
 4-14, 4-18, 4-20, 4-22, 4-27, 4-43, 4-48
 each parameters of page 3, 4, and in C
 detail4-17
 notch parameter4-31
 of IDD3-25
 port control parameter4-33
 structure3-21
 MODE SENSE.....3-30
 command parameter configuration...3-34, 3-35
 data type specification3-33
 MODE SENSE EXTENDED.....3-38
 command parameter configuration...3-39, 3-40
 MRIE (method of reporting informational
 exception condition).....4-45
 MS.....4-23
 multiple selection4-23

N

ND.....4-32
 non cache buffer size4-26
 non-medium error count page.....4-61
 not supported.....3-60, 3-78
 notch drive4-32
 notch parameter.....4-31
 number of head4-19
 number of retry
 during read.....4-4
 during seek error.....4-48
 during VERIFY4-21
 during write4-5

O

operation code 1-3, 3-3
 operation if formatting is not completed
 normally 1-26
 operation mode..... 3-12, 3-16
 setting 2-5
 other internal IDD error 5-24
 outline of
 command processing 1-8
 disk drive error recovery processing 1-27
 SCSI bus error recovery processing 1-27
 overlapping command..... 1-23

P

P list..... 3-82
 bit 3-95
 page
 code list..... 3-10, 3-103, 3-108
 descriptor 3-25
 length 3-25
 notch 4-33
 page 1 6-6
 page 3 6-4
 page 4 6-4
 page 8 6-6
 page code 3-3, 3-25, 3-52, 3-102, 3-107
 = 0A 4-27
 = 0C 4-31
 = 1 4-1, 5-26
 = 19 4-33
 = 1C 4-43
 = 1C/subpage = 01 4-47
 = 2 4-10
 = 21 4-48, 5-27
 = 3 4-14
 = 4 4-18
 = 7 4-19, 5-27
 = 8 4-21
 page descriptor 3-37
 page length 3-37, 3-52
 page parameter 3-103, 3-107
 length 3-103, 3-107
 parameter
 configuration 3-23
 data format 4-1
 field 3-37
 for controlling reconnection timing 2-5
 for specifying alternate processing area
 for defective block 4-15
 length 3-53
 value 3-54
 parameter list 3-16
 configuration 3-102
 length 1-4

parameter related to device type 4-16
 parameter specification 3-101
 parameter specifying
 sector format 4-16
 track format 4-15
 paramter code 3-53
 PER 4-4
 persistent reservation scope 3-59
 persistent reservation type 3-60
 code 3-61
 PERSISTENT RESERVE IN 3-55
 parameter data for READ KEY 3-57
 parameter data for READ
 RESERVATION 3-58
 service action 3-56
 PERSISTENT RESERVE IN command
 parameter data (READ KEYS) 3-57
 parameter data (READ
 RESERVATIONS) 3-58
 PERSISTENT RESERVE IN Reservation
 Descriptor) 3-59
 PERSISTENT RESERVE OUT 3-62
 command service action code 3-64
 parameter list 3-64
 service action 3-63
 service action and valid parameter 3-66
 PERSISTENT RESERVE OUT command
 parameter list 3-64
 Phase CRC 3-17
 PHSCRC 3-17
 physical sector address format 3-87, 3-88
 port control parameter 4-33
 post error 4-4
 pre-fetch inhibit block count 4-25
 primary defect list 3-82
 primary list 3-95
 product ID field 3-7
 product revision field 3-7
 protocol identifier 4-34
 protocol option bit 4-41
 protocol specific mode parameter 4-36
 PS bit 3-37

Q

QAS bit 3-8
 QErr 4-29
 qualifier
 field 3-5
 Qualifier 3-9
 queue algorithm qualifier 4-28
 queue error management 4-29
 quick arbitrate supported 3-8

R

- RAC.....4-30
- RAERP, UAAERP, EAERP, READY AER
 - HOLD OFF PERIOD4-30
- RC4-3
- RCD.....4-23
- READ.....3-71
- READ BUFFER.....3-115
 - command3-116, 3-117, 3-118
- read cache disable.....4-23
- READ CAPACITY3-13
 - data3-14
- read continuous4-3
- READ DEFECT DATA3-94
 - command (37).....3-95
 - command (B7).....3-99
- READ DEFECT DATA (B7).....3-98
- read error
 - count page.....4-54
 - in uncorrectable data.....5-23
- read error recovered
 - with possible delay4-55
 - without delay4-55
- READ EXTENDED.....3-72
- READ KEYS.....3-56
- READ LONG.....3-119
- read operation.....2-2
- READ RESERVATION3-57
- read/write error recovery parameter 4-1, 4-2, 5-26, 6-6
- reading and verification of data.....6-7
- REASSIGN BLOCK command3-92
- REASSIGN BLOCKS.....3-91
- RECEIVE DIAGNOSTIC RESULTS.....3-106
 - command3-107
 - response data.....3-108
- received (RCVD) PCOMP_EN.....4-41
- reconnection processing procedure1-14
- recovery procedure for disk drive error.....1-27
- recovery processing for error on SCSI bus1-26
- recovery time limit 4-6, 4-21
- reference temperature.....4-63
- re-initialization6-5
- release
 - function.....3-47
- RELEASE3-47
- RELEASE EXTENDED3-48
- release object and third party release
 - function.....3-47
- removable medium.....4-17
- report check4-30
- REPORT DEVICE IDENTIFIER
 - parameter list3-68
- REPORT DEVICE IDENTIFIER3-68
- report log exception condition4-29
- REPORT LUNS3-66
- REPORT LUNS command
 - parameter list3-67
- REQ/ACK offset4-40
- REQUEST SENSE.....3-48
 - command1-21
- reselection retry.....3-17
- reselection timeout delay3-18
- RESERVATION CONFLICT status.....1-8, 5-14
- RESERVE3-43
- RESERVE EXTENDED.....3-46
- reserve condition, changing3-44
- reserve right and third party reserve
 - function3-44
- reserved by Fujitsu4-48
- reserved operation code1-24
- reset processing1-28
 - during write1-29
- response and release condition
 - at sense data hold state1-22
 - at UNIT ATTENTION condition hold
 - state1-20
- response data
 - configuration3-107
- response data format field3-5
- response to link specification command1-10
- RFJ4-48
- RLEC4-29
- RMB.....4-17
 - bit3-5
- rotational position locking4-19
- rotational speed4-19
- rotational synchronization offset.....4-19
- RPL4-19
- RSRTY3-17
- RTD.....3-18

S

- SCSI-2 mode3-7
- SCSI-3 mode3-6
- SDTR3-17
- sector count/track4-15
- sector slip processing6-2
- SEEK.....3-77
- seek error.....5-23
- SEEK EXTENDED3-77
- self-diagnosis test.....3-100
- self-diagnostic error1-29
- self-test result
 - page4-67
- self-test result parameter data.....4-67
- Self-test results values.....4-68
- SEND DIAGNOSTIC.....3-99

- command3-102
 - parameter 3-103, 3-104
 - sense command3-1
 - sense data5-1
 - additional information5-12
 - analysis and error recovery method.....5-15
 - basic information5-2
 - error classification5-15, 5-16, 5-17, 5-18
 - error recovery methods.....5-1
 - format5-1
 - hold condition.....1-22
 - hold state.....1-22
 - in not ready state.....1-25
 - sense data hold state, other than1-21
 - sense data length3-36
 - sense key 5-3, 5-5
 - inherent information5-4
 - specific valid.....5-4
 - sent PCOMP_EN4-41
 - SET DEVICE IDENTIFER
 - parameter list3-70
 - SET DEVICE IDENTIFIER3-69
 - SET LIMITS3-78
 - command3-79
 - setting parameter by MODE SELECT
 - command6-6
 - single command1-8
 - SIZE4-24
 - size enable4-24
 - SKSV5-4
 - SMART data page.....4-72
 - SMART status page4-71
 - soft sectoring4-16
 - soft write protect4-30
 - spare sector area6-2
 - spare sector within cell.....6-2
 - specified cycle count over device lifetime4-65
 - specifying initialization method3-83
 - specifying range where access is permitted3-79
 - SPF 3-25, 3-37, 4-33
 - spindle motor start delay time3-18
 - SSEC4-16
 - standard INQUIRY data..... 3-3, 3-4
 - start specification3-42
 - START/STOP UNIT.....3-41
 - starting boundary.....4-33
 - start-stop cycle counter4-65
 - page4-63
 - status.....1-6
 - stop format3-85
 - stop specification.....3-42
 - STPF.....3-85
 - sub page format..... 3-25, 3-37
 - subpage code4-35
 - subpage length.....4-35
 - superseding reserve.....3-44
 - support3-9
 - supported function3-6
 - supprot log page.....4-49
 - SURF4-17
 - surface addressing4-17
 - SWP4-30
 - SYNCHRONIZE CACHE3-80
 - synchronous data transfer request.....3-17
 - synchronous mode data transfer.....1-15
 - synchronous transfer timeout.....4-34
- T**
- tagged queuing1-18
 - target certification list3-82
 - target save disable3-53
 - TASK SET FULL status1-8
 - task set type.....4-28
 - TB4-3
 - temperature
 - page4-62
 - termination status analysis and error
 - recovery method.....5-12
 - TEST UNIT READY.....3-1
 - threshold met criteria3-53
 - TMC.....3-53
 - total posted
 - read error4-56
 - recoverable verify error.....4-60
 - verify error4-59
 - total posted recoverable read error.....4-56
 - total posted recoverable write error4-53
 - total posted unrecoverable
 - verify error4-61
 - total posted unrecoverable read error.....4-57
 - total posted unrecoverable write error4-54
 - total posted write error4-52
 - total read byte processed.....4-57
 - total verify bytes processed.....4-60
 - total write byte processed.....4-53
 - track count/zone.....4-15
 - track skew factor.....4-16
 - transceiver mode4-41
 - transfer block4-3
 - count.....1-4
 - transfer byte length1-4, 3-3
 - transfer data length.....1-4
 - transfer period factor.....4-40
 - transfer width exponent4-40
 - TSD.....3-53
 - TST4-28
 - type of command and disconnect processing...1-12

-
- U**
- Unit Attention condition
 multiple hold.....1-22
UNIT ATTENTION condition.....1-19
UNIT ATTENTION report mode3-17
unrecoverable hardware error.....1-29
untagged queuing1-16
UNTATN3-17
user space logical block address.....1-32
- V**
- valid.....5-2
vefiry error recovered
 with possible delay4-59
vendor ID field3-7
vendor unique.....1-5
VERIFY3-76
verify error
 count page.....4-58
 recovered without delay.....4-58
 recovery parameter 4-19, 4-20, 5-27
verify error recovery parameter.....6-6
version 3-5, 3-9
 descriptor field.....3-8
VPD identifier list3-11
VPD information.....3-10, 3-11, 3-12, 3-16
- W**
- WCE.....4-23
WDTR.....3-16
wide mode data transfer1-15
- WP bit3-36
WRITE3-73
WRITE AND VERIFY3-75
WRITE BUFFER3-110
 command3-111
write cache2-11
 enable4-23
write error count page4-51
write error recovered
 with possible delay4-52
 without delay4-51
WRITE EXTENDED.....3-74
WRITE LONG3-120
write operation2-3
write retention priority4-24
WRITE SAME.....3-121
writing data pattern6-6
- X**
- X'00'4-49
X'01'4-50
X'02'4-51
X'03'4-54
X'05'4-58
X'06'4-61
X'0D'4-62
X'0E'4-63
X'0F'4-66
X'10'4-67
X'15'4-69
X'2F'4-71
X'38'4-72

READER'S COMMENT FORM

Your comments or suggestions on this document are cordially solicited. For any comments and suggestions you may have, please complete and submit this form to your FUJITSU representative. The comments and suggestions will be used in planning future editions. Thank you for your cooperation.

Date issued: _____ Manual name: MAW3073, MAW3147, MAW3300
 Name: _____ NP/NC SERIES MAX3036,
 Company or organization: _____ MAX3073, MAX3147 NP/NC SERIES
 _____ DISK DRIVES SCSI LOGICAL
 _____ INTERFACE SPECIFICATIONS
 Address: _____
 _____ Manual code: C141-C010-02EN

Comments:

Page	Line	Comments
Reply requested: <input type="checkbox"/> Yes <input type="checkbox"/> No		

Please evaluate overall quality of this manual by marking (✓) in the appropriate boxes.

	Good Fair Poor		Good Fair Poor
Organization: <input type="checkbox"/>	<input type="checkbox"/> <input type="checkbox"/> <input type="checkbox"/>	Use of examples: <input type="checkbox"/>	<input type="checkbox"/> <input type="checkbox"/> <input type="checkbox"/> Legibility: <input type="checkbox"/> <input type="checkbox"/>
Accuracy: <input type="checkbox"/>	<input type="checkbox"/> <input type="checkbox"/> <input type="checkbox"/>	Index coverage: <input type="checkbox"/>	<input type="checkbox"/> <input type="checkbox"/> <input type="checkbox"/> Handiness/Binding: <input type="checkbox"/> <input type="checkbox"/>
Clarity: <input type="checkbox"/>	<input type="checkbox"/> <input type="checkbox"/> <input type="checkbox"/>	Cross referencing: <input type="checkbox"/>	<input type="checkbox"/> <input type="checkbox"/> <input type="checkbox"/> _____(Others): <input type="checkbox"/> <input type="checkbox"/>
Figures & tables: <input type="checkbox"/>	<input type="checkbox"/> <input type="checkbox"/> <input type="checkbox"/>	General appearance: <input type="checkbox"/>	<input type="checkbox"/> <input type="checkbox"/> <input type="checkbox"/>
Technical level: <input type="checkbox"/>	Too high <input type="checkbox"/>	Appropriate <input type="checkbox"/>	Too low <input type="checkbox"/>
Overall rating of this publication: <input type="checkbox"/>	Good <input type="checkbox"/>	Fair <input type="checkbox"/>	Poor <input type="checkbox"/>

FOR FUJITSU USE

Overseas office: _____ Person in charge: _____

Note) Local representative should pass this form to the section in charge of distribution in FUJITSU.

Reply

By _____

This page is intentionally left blank.

FUJITSU