

VGB10 Video Terminal

Installation and Operating Information

Order Number: EK-VGB10-IB. B01

August 1993

Digital Equipment Corporation makes no representations that the use of its products in the manner described in this publication will not infringe on existing or future patent rights, nor do the descriptions contained in this publication imply the granting of licenses to make, use, or sell equipment or software in accordance with the description.

DEC, OpenVMS, ULTRIX, VMS, and VT are trademarks of Digital Equipment Corporation.

ADDS is a trademark of Applied Digital Data Systems, Inc.

IBM, ProPrinter, and PS/2 are registered trademarks of International Business Machines Corporation.

SCO is a trademark of Santa Cruz Operations, Inc.

TVI is a trademark of TeleVideo, Inc.

UNIX is a registered trademark of UNIX System Laboratories, Inc.

WY and WYSE are registered trademarks of Wyse Technologies.

All other trademarks and registered trademarks are the property of their respective holders.

© Digital Equipment Corporation 1993.

All Rights Reserved.

Printed in Taiwan.

FCC ID: A09-VGB10

Note: The international versions of this equipment have been tested and found to comply with the limits for a Class B digital device, pursuant to Part 15 of the FCC rules. These limits are designed to provide reasonable protection against harmful interference in a residential installation. Any changes or modifications made to this equipment may void the user's authority to operate this equipment.

This equipment generates, uses, and can radiate radio frequency energy and, if not installed and used in accordance with the instructions, may cause harmful interference to radio and television reception; however, there is no guarantee that interference will not occur in a particular installation. If this equipment does cause harmful interference to radio or television reception, which can be determined by turning the equipment off and on, the user is encouraged to try to correct the interference by one or more of the following measures:

- Re-orient or relocate the receiving antenna.
- Increase the separation between the equipment and the receiver.
- Connect the equipment to an outlet on a circuit different from that to which the receiver is connected.
- Consult the dealer or an experienced radio/TV technician for help.

Contents

Preface	v
1 Installation and Set-Up	
Install the tilt/swivel stand.	1-1
Install your terminal.	1-2
Set up your terminal.	1-4
Select the Set-Up language.	1-7
Select the emulation mode terminal type.	1-8
Select the keyboard language.	1-8
Select the communication/printer port configuration.	1-9
Select the communication word size.	1-9
Select the communication parity.	1-10
Select the communication transmit speed.	1-10
Select the communication receive speed.	1-11
Select the printer type.	1-11
Save your settings.	1-12
2 Desktop Features	
Invoking Desktop Features	2-1
Overview	2-1
Clock feature	2-2
Calculator feature	2-3
Show Character Sets feature	2-4
Banner message	2-4

3 Maintenance and Troubleshooting

Cleaning your Video Terminal	3-1
Troubleshooting	3-1
Disposing of your Terminal	3-4
Installing the ROM Cartridge	3-4

4 Defining Keys

Define Key Editor	4-1
-------------------------	-----

A Specifications

Acoustic Levels	A-5
VGB10 Terminal	A-6

B Keyboard Function Keys

User Definable Keys	B-1
Local Functions	B-1
Compose Characters	B-6

Figures

1-1	ANSI-Style Keyboard Layout	1-6
1-2	PC-Style Keyboard Layout	1-6
A-1	Serial Communication/Printer Ports	A-4
A-2	9-Pin EIA 232 Port	A-4
A-3	Parallel Printer Port	A-4
A-4	MMJ Adapter Pins	A-5

Tables

1	Recommendations for Proper Setup and Use	viii
3-1	Identifying and Correcting Problems	3-2
B-1	Local Functions	B-2
B-2	Other Available Local Functions	B-5

Preface

Overview

This guide is for users who wish to install and configure the VGB10 video terminal. This guide describes how to connect cables and enter the Set-up Menu to make changes, as needed. This guide also has reference tables for troubleshooting, specifications, and compose sequences.

For more detailed information on programming the terminal, refer to the *VGB10 Video Terminal Programmer Information*. See the inside back cover for ordering information.

Environment

Note

This product has been designed and manufactured to minimize the impact to the environment. The packaging is recyclable and the terminal can be returned for proper disposal.

Before You Start

Ensure that you have received the following:

- Video terminal
- Keyboard
- Power cord, if not attached to the terminal unit

A small flat-blade screwdriver may be needed to install the communication or the printer cables.

Obtain the following information before installing your VGB10 video terminal. Write any changes to the default setting in the column on the right.

Information Needed	Obtain From . . .	Changes to Default Setting
The keyboard country language that you have.	Bottom of the keyboard	_____
<u>Desired terminal:</u>	System Manager	_____
Emulation: ANSI-style , PCTerm, ADDS, SCO, TVI, WYSE	System Manager	_____
<u>Communication Information:</u>	System Manager	_____
Word size: 8 bits , 7 bits	System Manager	_____
Parity: none , even, odd, mark, or space	System Manager	_____
Transmit speed: 9600	System Manager	_____
Receive speed: Same as Transmit speed	System Manager	_____
<u>Printer Information:</u>	System Manager	_____
Printer type: DEC VT , IBM ProPrinter, or DEC + IBM	System Manager	_____
Printer serial speed: 4800	System Manager	_____

The factory defaults are in **boldface** type.

Conventions

The following conventions are used in this document:

Convention	Meaning
Shift Tab	Indicates two keys that you must press in combination. Press and hold the first key while you press the second key.
Shift Enter	Indicates two keys that you must press in sequence. Press and release the first key before you press the second.
Caps Lock Alt F11	Indicates three keys that you must press in combination, holding the first two down while pressing the third.
terminal	Describes the VGB10 video terminal.
Display	Menu items are in boldface type.
Note	Provides general information.
Caution	Provides information to prevent damage to equipment.
Warning	Provides information to prevent injury.

Proper Setup and Use

Important Information

Certain recent scientific literature suggests that poor posture, work habits, or office equipment setup may cause injuries. Other literature suggests that there is no cause and effect. Because the safety of our users is a great concern, it is important to take the precautions described in Table 1.

Proper Setup and Use

Table 1 Recommendations for Proper Setup and Use

Adjust	So that . . .
Chair	1 Feet are flat on the floor or footrest if needed.
	2 Legs are vertical forming a right angle to the floor.
	3 Your weight is off your thighs and are in a horizontal position. Keep the back of your knees away from the seat so you do not compress the area behind them, which could restrict the blood flow.
	4 Your upper body is erect and your lower back is supported with a backrest.
Keyboard	5 Your wrists are straight and do not flex more than 15°. They may be supported but should not rest on sharp edges.
	6 Upper arms are straight down at your sides, elbows are close to your sides and support your arm weight. Forearms are at a 70° to 90° angle.
Head	7 Your neck is not strained. Your head should incline downward, but no more than 15° to 20°.

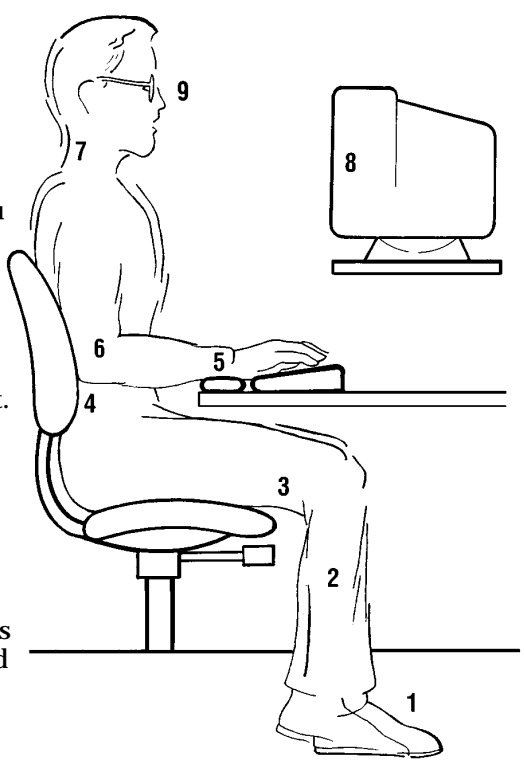

MA-0069-93.IL

(continued on next page)

Table 1 (Cont.) Recommendations for Proper Setup and Use

Adjust	To . . .
Terminal	8 Eye level and at the correct distance for proper vision.
Eyes	9 Avoid eye fatigue, which can be caused by glare, image quality, uncomfortable furniture, eye height, and uncorrected vision. If you cannot read the screen at different distances, you may need special glasses. Relax your eyes periodically by looking at distant objects.
Work Breaks	Take periodic work breaks. Morning, lunch, and afternoon breaks meet most recommendations. Take advantage of work breaks to move around and do other movements.
Lighting	Avoid direct lighting or sunlight on the screen, which causes glare and reflections. This terminal screen has an antiglare treatment to reduce glare. Place lighting behind or to the side of your work area, and distribute the lighting evenly on your work area. Adjust the brightness and the contrast controls as needed.
Noise	Keep background noise at a minimum. Background noise above 65 dBA is tiring. Sound-absorbing materials, such as curtains, carpeting, and acoustic tile, can help reduce background noise.
Temperature	20°C to 23 °C (68°F to 74°F)
Humidity	30% to 70%
Ventilation	Provide adequate air ventilation for equipment operation and to avoid fatigue.
Space between terminals	More than 70 cm (28 in) center to center, preferably more than 152 cm (60 in).

Warning

If you experience pain or discomfort during use of the terminal, then take a substantial break and review the instructions for posture and work habits. If the pain or discomfort continues after resuming use of the terminal, then discontinue use and report the condition to your job supervisor or physician.

1

Installation and Set-Up

Install the tilt/swivel stand.

1. Carefully set the terminal facedown.
2. Insert the hooks on the stand into the slots at the bottom of the terminal.
3. Slide the stand to the right until it is locked by the two tabs at the bottom of the terminal. (To remove the stand, press the two tabs.)

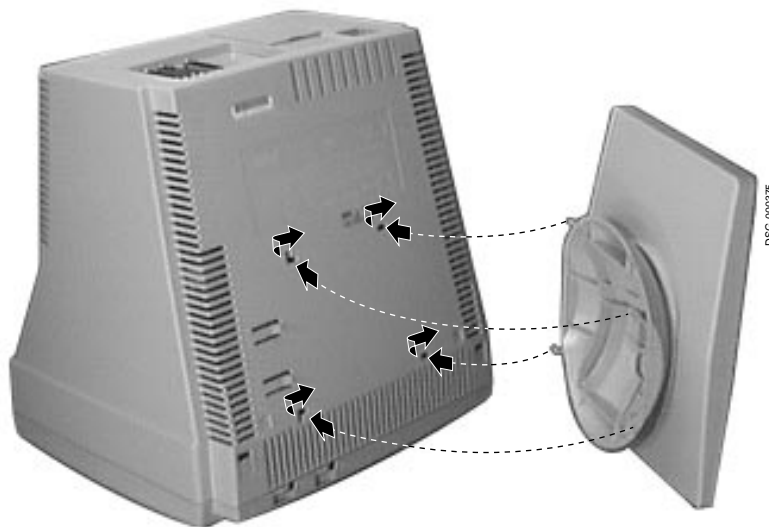

Install your terminal.

Install your terminal.

Connect the cables to the terminal.

To install your terminal, connect the cables to the terminal as shown.

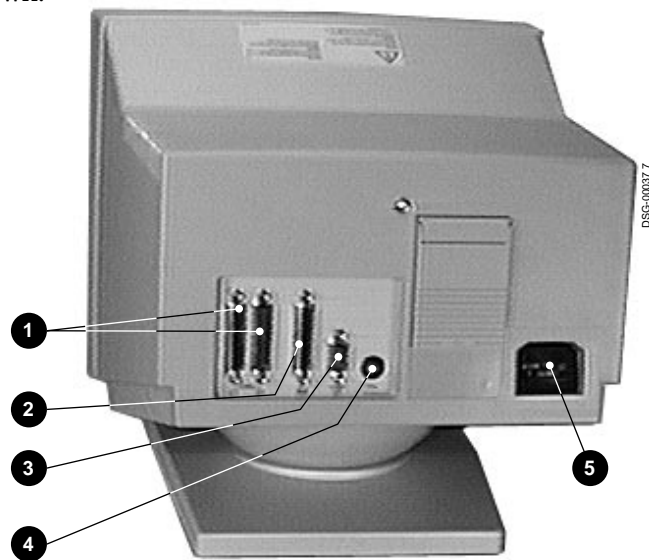

- ❶ Comm 1 (⇔) (male or female),
- ❷ Parallel (||), ❸ Comm 2, ❹ Keyboard, ❺ Power cord.

Install your terminal.

Plug in the power cord and push the power switch on.

The terminal will beep indicating that the power is on.

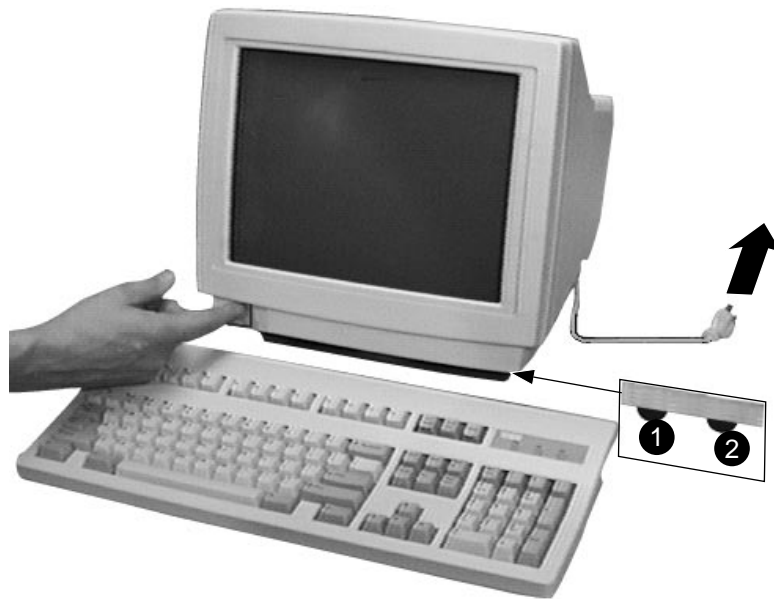

DSG-000321

Set the Brightness and Contrast controls.

If necessary, set the brightness and contrast controls by doing the following:

1. Set both controls to maximum by turning controls all the way to the right (→).
2. Adjust the Brightness control **2** by turning the control to the left (←) until the background raster is not visible. This sets the black level.
3. Adjust the Contrast control **1** by turning the control to the left (←) to set the white level for comfortable viewing.
4. Repeat steps 2 and 3 as needed.

Install your terminal.

"Selftest OK" appears on screen.

The terminal takes a few seconds to warm up and complete its power up self-tests. Then, the terminal should display **"Selftest OK."** If a problem occurs, go to Chapter 3.

Set up your terminal.

Overview

Use Set-Up to examine or change the terminal operating features, such as the transmit speed, receive speed, or the language. The Set-Up menus in this section will get you started in operating the terminal. Only the basic Set-Up feature is performed with this procedure. There are many more Set-Up features in the terminal that you may wish to change.

Before changing the Set-Up features, contact your System Manager, if necessary, for information on the terminal type, terminal ID to host, and the communication settings.

Printer operations are suspended upon entering Set-Up and are resumed upon exiting Set-Up.

Entering Set-up

To enter Set-Up, perform the following procedures:

On a . . .	Press . . .	Refer to . . .
ANSI-style keyboard	F3	Figure 1-1
PC keyboard	Caps Lock Print Screen	Figure 1-2

Set up your terminal.

Moving within a Set-Up Menu

Use the arrow keys (←, ↑, ↓, →) to move among the menus or within a list or to select buttons.

In a menu ...	Indicates ...
▷	A pull-right menu is available.
...	A dialog box is available for you to specify more information.
• a ○ b ○ c	The menu item with the filled-in circle is enabled. Only one of these items can be enabled at a time.
<input checked="" type="checkbox"/>	The menu item with the check box is enabled.

Press **Enter**, **Return**, **Do** or **Select** to start the action or to choose the currently highlighted feature.

A dimmed menu item does not apply to the currently selected mode.

Keyboards

An ANSI-style keyboard (Figure 1-1) and a PC keyboard (Figure 1-2) differ in the placement of some of the keys, such as the arrow keys. An ANSI-style keyboard has 20 function keys (F1 - F20) above the main keypad, while a PC keyboard has 12 function keys (F1 - F12).

Note

Keyboards from other manufacturers may function differently because of differences in their implementation of the PC keyboard standard.

Set up your terminal.

Figure 1–1 ANSI-Style Keyboard Layout

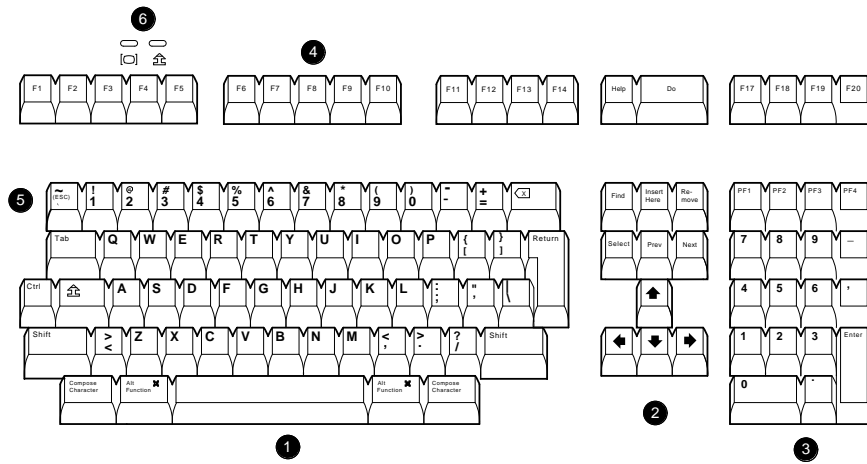

MA-1520-92.DG

Figure 1–2 PC-Style Keyboard Layout

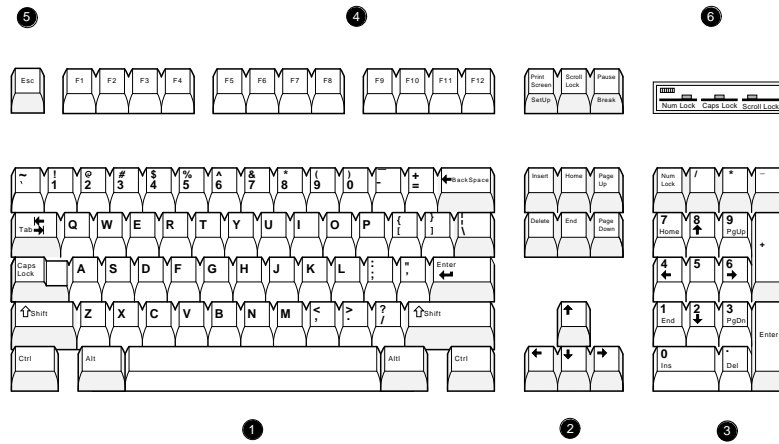

LJ-00226-T10

- ❶ Main keypad, ❷ Editing keypad, ❸ Numeric keypad,
- ❹ Function keys, ❺ Escape key, ❻ Indicator lights.

Select the Set-Up language.

Select the Set-Up language.

This language selection is for Set-up only and does not affect the keyboard, the character set, or the printer settings. As you make changes to some Set-Up parameters, the Set-Up summary line will reflect those changes.

Terminal Set-Up

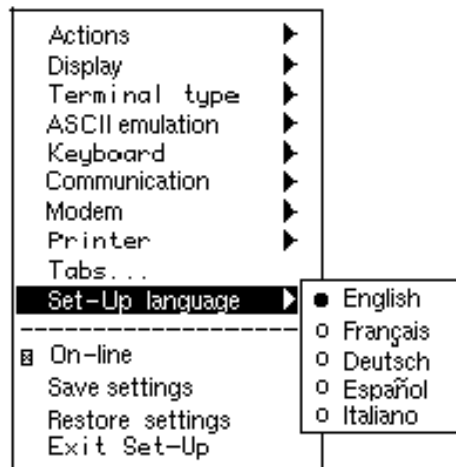

S1=comm1 9600N81 ISO Latin-1 North American VT320
① ② ③ ④ ⑤

① Port selected, ② Transmit speed (9600), Parity (N), Word size (8), Stop bits (1), ③ Character set, ④ Keyboard language, ⑤ Emulation mode.

Select the emulation mode terminal type.

Select the emulation mode terminal type.

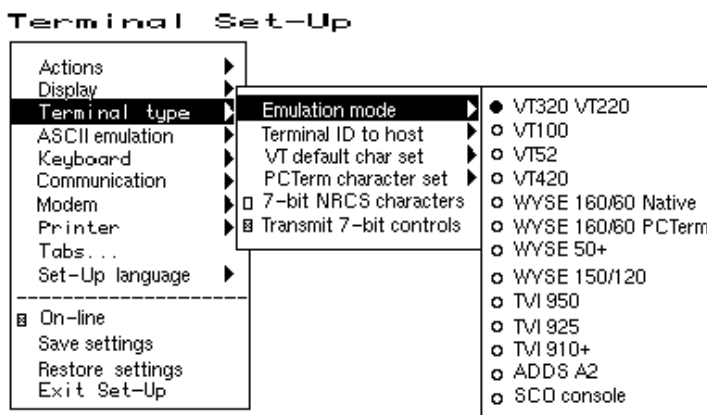

Select the keyboard language.

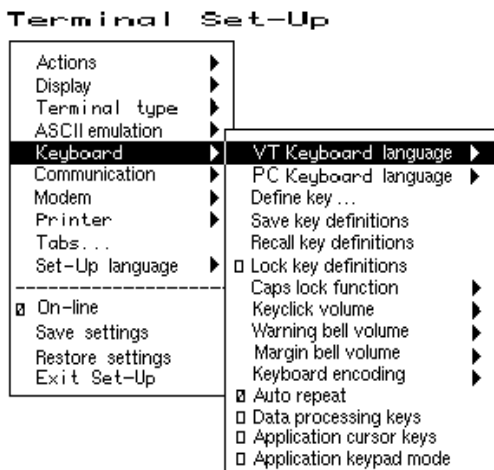

MA-0044-93.GRA

Select the communication/printer port configuration.

Select the communication/printer port configuration.

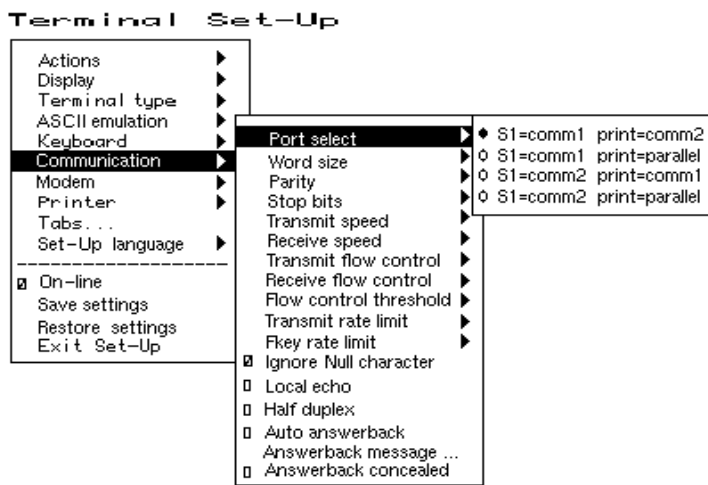

Select the communication word size.

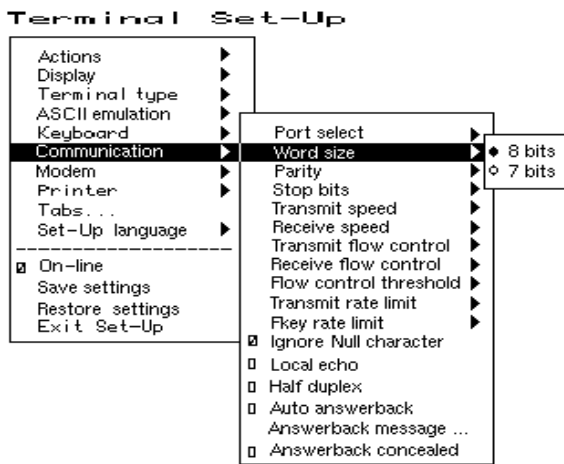

Select the communication parity.

Select the communication parity.

Terminal Set-Up

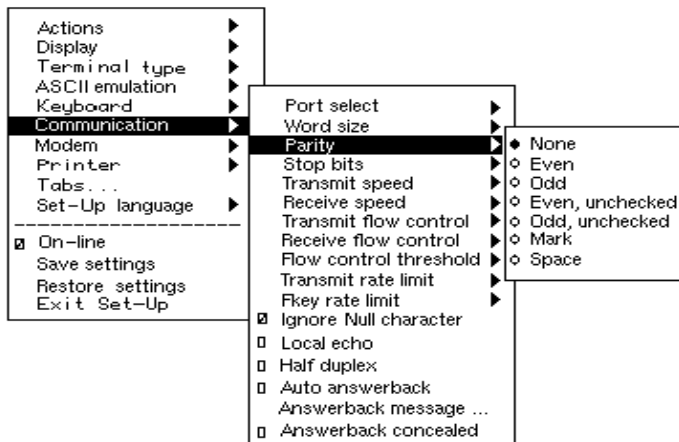

Select the communication transmit speed.

Terminal Set-Up

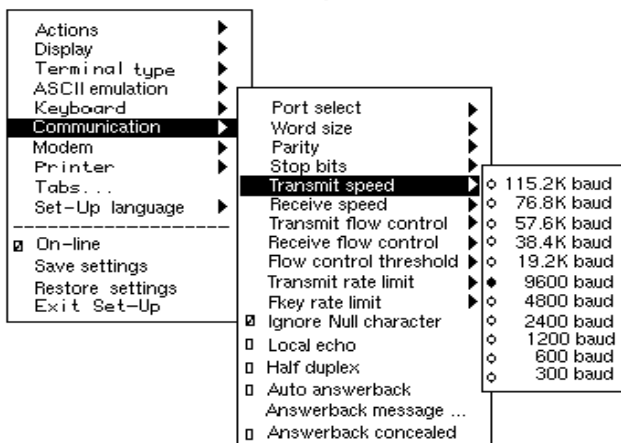

Select the communication receive speed.

Select the communication receive speed.

Terminal Set-Up

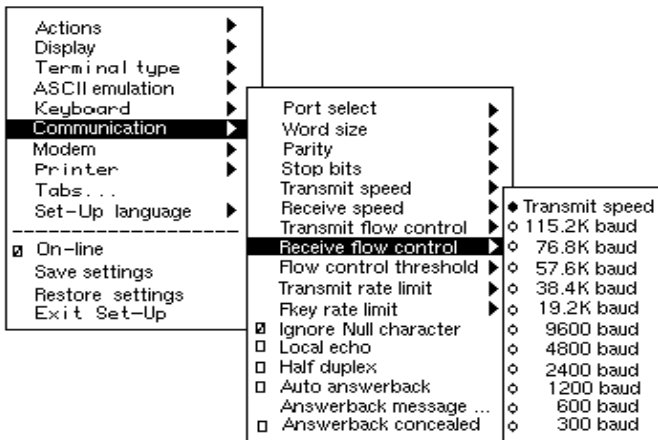

Select the printer type.

Terminal Set-Up

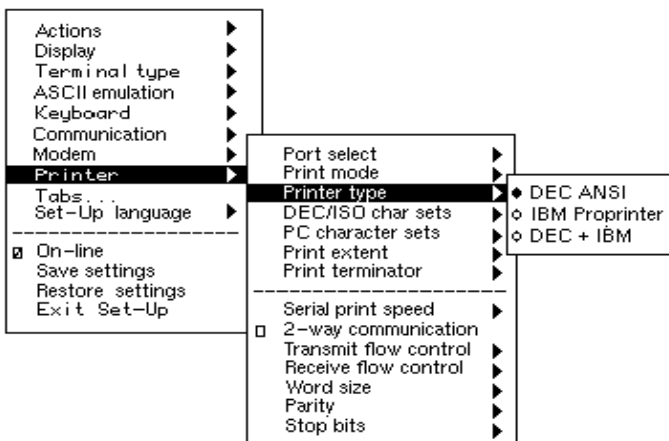

Save your settings.

Save your settings.

Select the **Save settings** menu item, then press **Enter** or **Return**.

Caution

If you disable the Screen Saver feature, an image may etch onto the screen, which may shorten the terminal's useful life.

Restore the settings.

To recall the settings that you stored in memory using the **Save Settings** menu item, select the **Restore settings** menu item and press **Enter** or **Return**.

Note

Restore factory defaults is a selection included in the **Action** menu.

Exit the Set-Up menu.

To exit Set-Up, select the **Exit Set-Up** menu item or perform the following procedure:

On a . . .	Press . . .	Refer to . . .
ANSI-style keyboard	F3	Figure 1-1
PC keyboard	Caps Lock Print Screen	Figure 1-2

2

Desktop Features

Invoking Desktop Features

Overview

From the **Actions** menu, you can invoke the **Clock**, **Calculator**, and **Show character sets** desktop features. When the feature is highlighted (displayed in reverse video), press **[Enter]** or **[Return]** to enable the feature. You can also invoke the Banner message dialog box by selecting the **Banner message** menu item from the **Actions** menu.

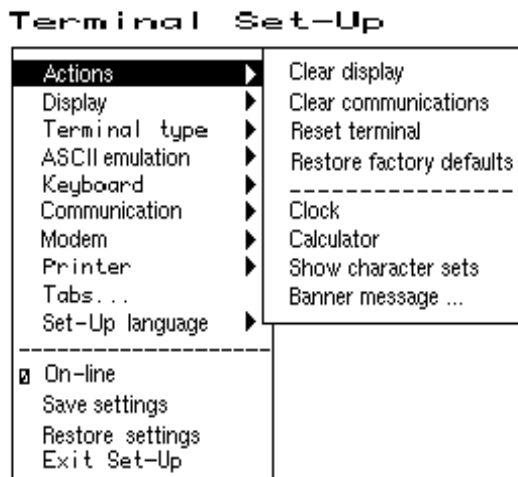

MA-0031-93.GRA

While these desktop features are enabled, other terminal functions are disabled. Press **[Ctrl Z]**, **[F10]**, **[Exit]**, or **[Esc]** to exit the feature.

Invoking Desktop Features

Clock feature

You can enable the **Clock** feature without entering Set-Up by pressing `Caps Lock Alt F11` if you are not in an ASCII emulation mode.

The current time is displayed in the status line if this feature is enabled. The format is HH:MM, followed by AM or PM if the 12-hour format is selected. Use the following keys within the clock feature:

Key	Function
<code>↓</code> or <code>Tab</code>	Go to next field.
<code>↑</code> or <code>Shift Tab</code>	Go to previous field.
<code>←</code> or <code>→</code>	Move within a field.
<code>Return</code> or <code>Enter</code>	If desired, check the 24-hour format box. For example, before entering 13:00, enable 24-hour format .
<code>A</code> or <code>P</code>	For 12-hour format, set the time to morning by pressing <code>A</code> or <code>P</code> for afternoon.

If the clock feature is enabled, then the alarm sounds for five seconds or until a key is pressed. Each alarm message can be up to 20 characters and will be displayed in the status line until a key is pressed. If the hourly chime is enabled, then the terminal will beep once every hour. In Set-Up, select the **Save settings** menu item to save the time format. The clock feature is disabled when the terminal is turned off.

Calculator feature

You can enable the **Calculator** feature without entering Set-Up by pressing **[Caps Lock] [Alt][F12]** if you are not in an ASCII emulation mode.

In addition to the numbers on the numeric keypad, you can use the following keys with the calculator:

Key	Function
[H] , [O] , or [D]	Select hexadecimal [H] , octal [O] , or decimal [D] format.
Arrow keys	Move the position of the calculator on the screen.
[Shift]	Change the keypad display to allow selecting [STO] , [RCL] , [1/x] , [X²] , and [Insert Result] .
[Alt]	Change the keypad display to hexadecimal and allow selecting keys [A] through [F] on the numeric keypad.
[C/E]	Clear the entry.
[STO]	Store the number in the display into memory.
[RCL]	Recall the number from memory and placing it in the display.
[Shift] [Enter]	Insert the result at the current cursor position after exiting the calculator feature.

All calculator math operations have equal priority except $1/x$ and x^2 . If a result is wider than the display, then a rounded number will be displayed. The non-rounded result will continue to be used in subsequent calculations. The decimal point cannot be used with the hexadecimal mode.

Invoking Desktop Features

Show Character Sets feature

You can enable the **Show character sets** desktop feature without entering Set-Up by using **[Caps Lock][Alt][F10]** if you are not in an ASCII emulation mode. When the character set is displayed, you can use the following keys with this feature:

Key	Function
[Next] or [Prev] [Page Up] or [Page Down]	Look through the available character sets.
[Shift] [L]	Display the line drawing character set if you are using a VT character set.
[Shift] [T]	Display the technical character set.
[Shift] [Enter]	For the current character set, insert the highlighted character into text at the current cursor position, if you are using a VT character set.

Banner message

From the **Actions** menu, select **Banner message....**

1. Press **[Return]** or **[Enter]** to display a dialog box.
2. Enter your banner message.
3. Press the **[↓]** to select the **[OK]** button.
4. Press **[Return]** or **[Enter]** to return to the Set-up menu.

3

Maintenance and Troubleshooting

Cleaning your Video Terminal

Cleaning the Screen

Before cleaning the screen, set the terminal power switch to the off position and wait 20 seconds to let static electricity dissipate. Clean the screen with a video screen cleaner.

Cleaning the Keyboard

If needed, wipe the keys with a soft cloth. Do not allow moisture to get under the keys.

Troubleshooting

Identifying and Correcting Problems

The following can be sources of problems:

- Communications cables
- Host system
- Nearby power or electrical sources

Troubleshooting

Troubleshooting Table

Use Table 3–1 to identify and correct any problem areas.

Table 3–1 Identifying and Correcting Problems

Symptom	Possible Cause	Suggested Solution
Cursor or "Selftest OK" does not display.	Brightness or Contrast control is set too low.	Increase the brightness and contrast control setting under the front of the terminal.
	Power cord is not connected.	Connect the power cord to the power source and the terminal. Push the power switch in.
	There is no power.	Use a functional outlet.
	The terminal is faulty.	Set the power switch to the off position and contact the service representative.
Screen is blank, but cursor is blinking.	Screen saver is active.	Press any key.
	Signal cable is not connected.	Reconnect the cable.
	Communication port is not set properly.	From the Communication menu item, choose Port select and check the setting for the cable connections.
	Communication speed may be set incorrectly.	Check the communication transmit speed, receive speed, and parity with your system manager; then match them to the Set-Up settings.
	The terminal or host system is faulty.	Set the power switch to the off position and contact the service representative.
Video is off center.	The Earth's magnetic field at your location may be causing the display to shift.	From the Display menu item, choose Screen alignment .

(continued on next page)

Table 3–1 (Cont.) Identifying and Correcting Problems

Symptom	Possible Cause	Suggested Solution
Video display has moving dots and distorted lines. The display rolls or flickers.	There is electromagnetic interference.	Move any electromechanical device, such as a fan or a motor, away from the terminal or move the terminal. CAUTION: Before moving the system, turn the power off and wait 20 seconds to let static electricity dissipate.
	Refresh rate is too low.	From the Display menu item, choose Refresh rate and select 72 Hz.
	The terminal is faulty.	Set the power switch to the off position and contact the service representative.
The printer will not print.	The printer power is not on.	Turn on the power to the printer.
	The printer cables are not connected.	Check the cables.
	Communication port is not set correctly.	From the Communication menu item, choose Port select and match the setting to the connections on the terminal.
	If you have a serial printer, its speed may be set incorrectly.	From the Printer menu item, choose Serial print speed and match the setting to the one in your printer manual.
Modifier keys remain in effect after released.	Accessibility aid enabled.	Check keyboard indicator line for icon. This feature is enabled by pressing any modifier key five times. To disable, press and hold a modifier key and then press another key.

Disposing of your Terminal

Warning

If you need to dispose of your terminal, ask a qualified service representative for the proper disposal procedures. Improper disposal could result in personal injury.

Installing the ROM Cartridge

Introduction

The terminal can accommodate an optional ROM cartridge at the back of the terminal. This ROM cartridge will completely replace the factory-installed software within the terminal for new software versions or special applications.

When an option ROM is not used, the ROM cartridge holder is empty with a cover over it.

Installing and Removing the ROM Cartridge

To install a ROM cartridge:

1. Set the power switch to the off position.
2. Remove the blank cover by lifting the cover from the bottom and gently pulling it straight back.
3. Plug in a ROM cartridge with its attached cover **1**, and close the cover.

Installing the ROM Cartridge

If you are having the terminal serviced, then remove and save the ROM cartridge. To remove a ROM cartridge, lift its cover from the bottom and gently pull it straight back.

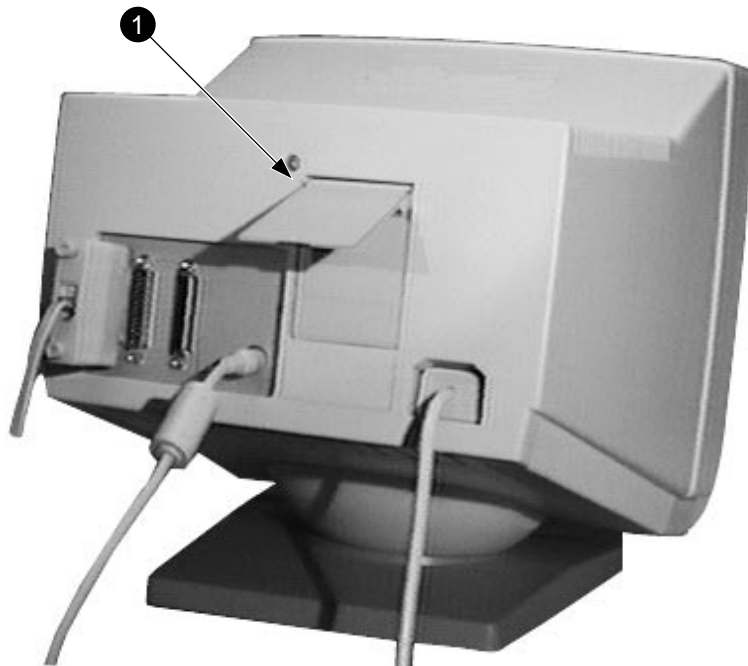

DSG-000372

4

Defining Keys

Define Key Editor

Overview

The VGB10 provides a powerful Define Key Editor that allows you to modify the function of keys on your keyboard. Since VGB10 keystrokes can perform many different functions, it will take some practice to understand how the keys work. This section is an introduction to customizing your keyboard.

Moving Standard Functions

The simplest way to re-program a key is to copy the behavior of another key. This method allows you to move factory default key functions to any position on the keyboard. To move factory default key functions:

1. From the **Keyboard** menu item, select the **Define key . . .** function, and the **Define Key Editor** menu will appear.
2. Press the key for which you want to assign a new behavior.
3. Press the key to highlight the "Copy of key default" radio button (Copy of key default) and press .
4. Press the key whose factory default behavior is what you want your defined key to do.
5. Press the key to highlight the OK or Apply pushbutton and press .

Define Key Editor

Customization

If you want to program a key to behave differently than one of the factory defined keys, then you will need to know about the following VGB10 key categories:

- Function:** Keys used to transmit function key sequences or to perform local terminal functions such as the arrow keys (↑, ↓, ⇒, ⇐), the **Shift** modifier key, or the **Set-Up** key.
- Alphanumeric:** Keys used to transmit alphanumeric characters.

Modifier Keys

Modifier keys vary from within the function and alphanumeric categories. A modifier key is a key that modifies the behavior of other keys when it is pressed and held down. For example, pressing an alphanumeric key in combination with the **Shift** modifier key will normally send the shifted or uppercase characters for that key.

Modifier keys are treated as a special kind of local terminal function. The VGB10 function modifier keys are: **Shift**, **Ctrl**, and **Alt**. VGB10 alphanumeric keys can also be modified by pressing **Group Shift** (**Alt Gr** on enhanced PC keyboards) and **AltShift** (**Shift-2**). Modifier keys themselves cannot normally be modified by other keys. A key assigned to act as the **Shift** modifier, for example, cannot transmit a function sequence when pressed in combination with the **Alt** key. Defining a key as a modifier key makes all assignable combinations of that key act as a modifier.

Creating a New Function

To define a new function key:

1. From the **Keyboard** menu item, select the **Define key . . .** function, and the **Define Key Editor** menu will appear.
2. Press the key for which you want to assign a new behavior.
3. Press the ⇐ and ⇒ keys to highlight the "Function" radio button (• Function) and press **Enter**.
4. Press the ↑ and ↓ keys to highlight the modifier combination that you want to define (unshifted, shifted, control, and so on) and press **Enter**.
5. Press the ⇒ key to move to the "Select function" scroll box. Press the ↑ and ↓ keys to highlight the desired keystroke function from the list and press **Enter**.

6. Press the **[←]** key to return to the modifier selection.
7. Repeat steps 4 through 6 to define other modifier combinations as desired.
8. Use the arrow keys (**[↑]**, **[↓]**, **[←]**, **[→]**) to highlight the OK or Apply pushbutton and press **[Enter]**.

Correcting a Mistake

If you make a mistake or want to start over, select the Cancel pushbutton or select the **Exit Set-Up** menu item. Your changes will not be recognized until you select the OK or Apply pushbutton. To save your key definitions so they will be available the next time you turn on the system power, select the **Save key definitions** menu item from the **Keyboard** menu.

Examples of Uses

Examples of when to create new functions include:

- To change the **[<X]** key to delete when unshifted and to backspace when shifted
- To disable the **[Compose]**, **[Break]**, or **[Set-Up]** key by assigning them to have no function

The Define Key Editor can be very powerful if you take the time to learn how to use it. No matter how you redefine the keys, you can always enter Set-Up by pressing **[F3]** after powering on. Additionally, you can always restore the factory default settings by invoking the **Actions** menu item.

Note

See the *VGB10 Video Terminal Programmer Information* manual to redefine alphanumeric keys or keyboard layouts.

A

Specifications

Video Terminal

The following are the specifications for the video terminal.

Dimensions

Height 32 cm (12.6 in)

Width 31.5 cm (12.4 in)

Depth 33 cm (13 in)

Weight 7.9 kg (17.4 lb)

Tilt Range 25° (5° forward, 20° backward)

Swivel Range ± 90° (left and right)

Display

Cathode ray tube (CRT) 35 cm (14 in) diagonal antiglare flat-profile screen

Overscan 60 Hz - 16 × 10 font; 72 Hz - 13 × 10 font

Area 800 × 432 pixels with 88 DPI density

Usable area 17 cm (6.7 in) × 23 cm (9 in); 1:1.4 aspect ratio

No. of lines 25, 42, or 53 data lines

Page size Selectable 24, 25, 36, 42, 48, 50, and 72 lines (emulation dependent)

Operating Systems Supported UNIX, MDOS, OpenVMS, VMS, or any other that supports ASCII or ANSI protocols.

Terminal Emulations ANSI, PCTerm, and ASCII emulations: VT, WYSE, TVI, ADDS, or SCO console.

Specifications

Character Set Support	Multiple languages using ISO and IBM code pages; Set-Up selectable in five languages.
Productivity Features	Local copy and paste Time-of-day clock—sound alarms and display messages Desktop calculator—insert result into text Show character sets—insert character into text
ROM cartridge support	4-Mbit (512 K byte) customer-installable ROM cartridge at back of system unit that completely replaces the factory-installed ROM code for new versions of the terminal's firmware.
Electrical Requirements	
AC input voltage	120 Vac only; or 110, 120, 220, 230, 240 auto-sensing (product variant) single phase, 3-wire
Line frequency	47 Hz to 63 Hz
Power consumption	40 watts maximum
Operating Temperature	10°C to 40°C (50°F to 104°F)
Humidity	10% to 90% relative humidity Maximum wet bulb = 28°C Minimum dew point = 2°C (noncondensing)

Keyboard

The following are the specifications for the keyboard.

Keyboard style	LK411/LK412 for ANSI/ANSI WPS style layout; PCXAL for enhanced PC 101/102 style layout; available for most European languages.
Protocol	IBM enhanced PS/2-compatible
Connector	PS/2-style, 6-pin mini DIN
Keyboard keys	All keys are programmable for single characters, character sequences, or local functions.
Nonvolatile memory	768K bytes memory User-defined key maximum length = 255 bytes.

Cables

The 25-pin D-sub connectors (Comm1) use an EIA-232 cable, with maximum cable length of 15.3 m (50 ft).

The parallel printer connector can use a 25-pin D-sub male to 36-pin Champ male.

The 9-pin female connector (Comm2) uses any standard PC serial cable.

Communication/Printer Ports

Serial	Bidirectional serial communication/printer ports with full modem support at 300 to 115.2K baud:	
	<u>EIA 423</u>	<u>EIA 232</u>
	Comm 1 (Figure A-1): Two 25-pin D-sub m/f (use one or the other)	Comm 2 (Figure A-2): 9-pin D-sub f
Parallel	Centronics (25-pin D-sub f) parallel printer connector (Figure A-3).	

m = male; f = female

Specifications

Figure A-1 Serial Communication/Printer Ports¹

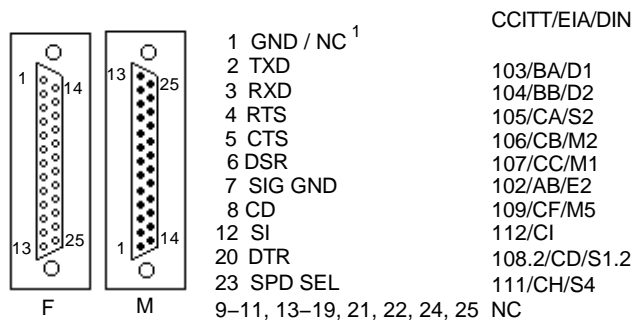

MA-0019-93.GRA

Figure A-2 9-Pin EIA 232 Port

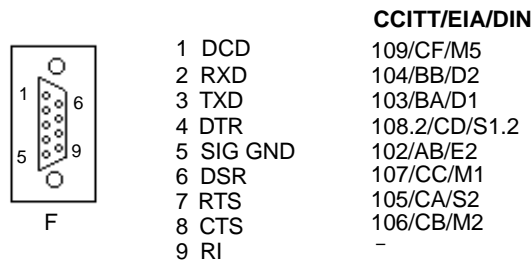

MA-0021-93.GRA

Figure A-3 Parallel Printer Port

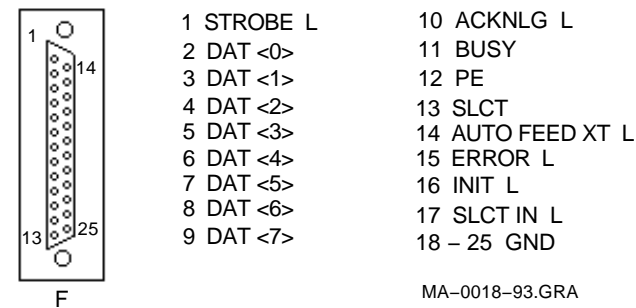

MA-0018-93.GRA

¹ In North America, pin 1 is open; in international units, pin 1 is ground. NC = Not connected.

Adapters

An MMJ adapter can be used with the 25-pin connector. Use an EIA-423 cable with a maximum cable of 76 m (250 ft). Figure A-4 shows the MMJ adapter pins.

Figure A-4 MMJ Adapter Pins

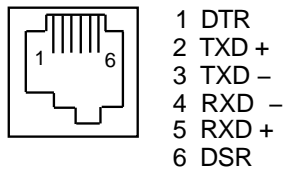

MA-0020-93.GRA

Acoustic Levels

Acoustic Noise

Preliminary declared values per ISO 9296 and ISO 7779:

Product ¹	Sound Power Level		Sound Pressure Level ²	
	Idle	Operate	Idle	Operate
VGB10	<3.9	<3.9	<22	<22
PCXAL	NA	6.0	NA	51
PC7XL	NA	5.3	NA	47
LK411	NA	5.6	NA	52

¹1 B = 10 dBA.

²Operator position.

VGB10 Terminal

VGB10 Terminal

Agency	Type	Standard	Subject
CSA	Safety	CSA 22.2 #950 M1989	Safety of Information Technology Equipment Including Electrical Business Equipment (Canada)
		CSA 22.1	Canadian electrical code
CISPR-22	EMI/FRI	CISPR-22 Class A	Electromagnetic compatibility
EIA	Telcom	EIA 423 EIA 232-E	Serial communications
DOC Canada	EMI/RFI	CSA 108.8	North American Class A version
FCC	EMI/RFI	FCC part 15 Class B	Electromagnetic compatibility
Australia PTT German PTT Japan PTT Sweden PTT	Telcom	CCITT V.24 and V.28	Serial communications
Australia	Safety	AS3260	Australia product safety
TUV	Safety	EN60950 (2nd ed, 1988) EN60950 (Amd 1 & 2, 1990) IEC950 (2nd ed, 1991) German X-Ray Act RöV §5(2) EMKO-TSE (74-SEC) 203/92 SS 436 14 90, MPR II	Safety of Information Technology Equipment Including Electrical Business Equipment GS-Mark (Geprüfte Sicherheit)
TUV	Ergonomic	ISO/DIS 9241-3	VDT Ergonomic Requirements
UL	Safety	UL 544 (2nd ed) UL 1950 (1st ed) NFPA 70	Standard for Medical and Dental Equipment Safety of Information Technology Equipment Including Electrical Business Equipment U.S. National Fire Protection Agency - National Electrical Code

Agency	Type	Standard	Subject
VDE	EMI/RFI	Vfg 243/1991 EN55022 class B	Radio Protection Mark
VCCI (Japan)	EMI/RFI	Class 1	Electromagnetic compatibility

この装置は、第一種情報装置（商工業地域において使用されるべき情報装置）で商工業地域での電波障害防止を目的とした情報処理装置等電波障害自主規制協議会（VCCI）基準に適合しております。

従って、住宅地域またはその隣接した地域で使用すると、ラジオ、テレビジョン受信機等に受信障害を与えることがあります。

取扱説明書に従って正しい取り扱いをして下さい。

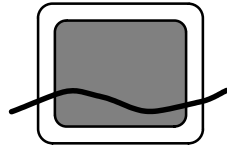

In addition to the standards listed previously, the VGB10 low-emissions video terminal complies with the following standards:

Agency	Type	Standard	Subject
NBOSH	EMI/RFI	MPR-2 1990:8	Swedish National Council for Metrology and Testing Display Units
	EMI/RFI	SS 436 14 90	Swedish standard for low emissions

VGB10 Terminal

**Flame
Retardants**

The thermoplastic enclosures do not contain polybrominated diphenylether (PBDE) as a flame retardant additive; therefore, they do not emit toxic dibenzofuran and dibenzodioxin gases.

PVC

The plastic enclosures are not made of rigid PVC. The material has a non-halogenated, flame-retardant system and is cadmium free.

Asbestos

Asbestos is not used in this product or in its manufacturing process.

**Ozone
Depleting
Substance**

The VGB10 is in full compliance with the labeling requirements in the U.S. Clean Air Act Amendments of 1990. It does not contain, nor is it manufactured with, a Class 1 ODS, as defined in Title VI Section 611 of this act.

B

Keyboard Function Keys

User Definable Keys

Overview

All keyboard keys are programmable by selecting the **Define key function** from the **Keyboard** menu item in Set-Up. They can be programmed to send single characters or character sequences, or to invoke a local function, such as Print Screen.

The function keys have the following key levels: Unshifted, Shifted, Control, Shift Control, Alt, Alt-Shift, Alt-Control, and Alt-Shift-Control.

Local Functions

Overview

The keys used to perform local terminal functions differ between the VT keyboard, PC keyboard, and the mode selection. Table B-1 shows the corresponding keys for the default local functions and their function number. This number is used in the DECPFK host sequence or DECPAK's alternate function to specify a change to that Local Function key. Table B-2 lists other available local functions.

Local Functions

Table B-1 Local Functions

Function Number	Function	VT Keyboard	SCO Console	PC Keyboard VT-Style	PC Keyboard PC-Style	PC Keyboard SCO
0	no function					
1	Hold	F1	Lock F1	F1	Scroll Lock	
2	Print	F2	Lock F2	F2	Print Screen	
3	Set-Up	F3	Lock F3	F3	Lock Print Screen Lock Sys Rq or Alt Print Screen	
5	Break	F5	Lock F5	F5	Lock Pause	
7	Hard Reset	Ctrl F3	Lock Ctrl F3	Ctrl F3	Ctrl Lock Print Screen	
8	Toggle Autoprint	Ctrl F2	Lock Ctrl F2	Ctrl F2	Ctrl Print Screen	
9	Disconnect	Shift F5	Lock Shift F5	Shift F5	Shift Lock Pause	
10	Send Answerback	Ctrl F5	Lock Ctrl F5	Ctrl F5	Ctrl Lock Pause	
11	Print Composed Main Display	Shift F2	X ¹	Shift F2	Shift Print Screen	X
20	Pan Up	Ctrl ↑	X	Ctrl ↑	Ctrl ↑	X
21	Pan Down	Ctrl ↓	X	Ctrl ↓	Ctrl ↓	
24	Pan Prev Page	Ctrl Prev	X	Ctrl Page Up	Ctrl Page Up	
25	Pan Next Page	Ctrl Next	X	Ctrl Page Down	Ctrl Page Down	
30	Copy & Paste Mode	F1 (hold down)	Caps Lock F1	F1	Scroll Lock	

¹ X means the function is not available in the default SCO state. If there is no "X" in the **SCO Console** column, then this means that the key sequence is the same as the **VT Keyboard** column. If there is no "X" in the **PC Keyboard SCO** column, then this means that the key sequence is the same as the **PC Keyboard PC-Style** column.

± means the function switches alternately between on and off.
 C&P means Copy and Paste.
 Lock means the Lock key, Caps Lock key, or key with lock icon.

(continued on next page)

Table B-1 (Cont.) Local Functions

Function Number	Function	VT Keyboard	SCO Console	PC Keyboard VT-Style	PC Keyboard PC-Style	PC Keyboard SCO
31	C&P Cursor Left	←		←	←	
32	C&P Cursor Down	↓		↓	↓	
33	C&P Cursor Up	↑		↑	↑	
34	C&P Cursor Right	→		→	→	
35	C&P Start Selection	Select		Home	Home	
36	C&P Copy	Remove		End	End	
37	C&P Paste	Insert Here		Insert	Insert	
38	C&P ± Left-to-Right	Select		Home	Home	
41	Shift Modifier	Left or right Shift		Left or right Shift	Left or right Shift	
42	Control Modifier	Ctrl		Left or right Ctrl	Left or right Ctrl	
43	Alt Function Modifier	Left or right Alt		Left or right Alt	Left or right Alt	
44	Start Compose	Left or right Compose			Left Alt Space	
45*	Group Shift Modifier	Group Shift		AltGr	AltGr	

¹ X means the function is not available in the default SCO state. If there is no "X" in the **SCO Console** column, then this means that the key sequence is the same as the **VT Keyboard** column. If there is no "X" in the **PC Keyboard SCO** column, then this means that the key sequence is the same as the **PC Keyboard PC-Style** column.

± means the function switches alternately between on and off.
C&P means Copy and Paste.

Lock means the Lock key, Caps Lock key, or key with lock icon.

(continued on next page)

Local Functions

Table B-1 (Cont.) Local Functions

Function Number	Function	VT Keyboard	SCO Console	PC Keyboard VT-Style	PC Keyboard PC-Style	PC Keyboard SCO
46†	Shift2 Modifier	Alt Shift				
47	Primary KB language	Ctrl Alt F1	Lock Alt Ctrl F1	Ctrl Alt F1	Ctrl Alt F1	See SCO Console
48	Secondary KB language	Ctrl Alt F2	Lock Alt Ctrl F2	Ctrl Alt F2	Ctrl Alt F2	See SCO Console
49‡	± KB language					
51	± Caps Lock State	Lock		Lock	Lock	
52	± Num Lock State			Num Lock	Num Lock	
53	± VT/IBM Style		X	Lock Num Lock	Lock Num Lock	X
54	Extend Kbd Modifier			Lock	Lock	
61	Screen saver					
62	Calculator	Lock Alt F12		Lock Alt F12	Lock Alt F12	
63	Clock	Lock Alt F11		Lock Alt F11	Lock Alt F11	
64	Character table	Lock Alt F10		Lock Alt F10	Lock Alt F10	
65	Transfer result	Shift Enter		Shift Enter	Shift Enter	

†The Shift2 Modifier is assigned to the Alt Shift key (German "Right Compose") when it appears on the corresponding keyboard (German).

‡Toggle KB language is assigned to the named language key when it appears on the corresponding keyboard (Greek, Hebrew, and Russian).

± means the function switches alternately between on and off.
C&P means Copy and Paste.

Lock means the Lock key, Caps Lock key, or key with lock icon.

Table B–2 Other Available Local Functions

Function Number	Function	Function Number	Function
91	BS	120	Page 0
92	CAN	121	Page 1
93	ESC	122	Page 2
94	DEL	123	Page 3
100	UDK sequence	124	Page 4
105	Soft reset	125	Page 5
106	±Show controls	126	Page 6
111	±Status display	138	Prev Page
112	±Split screen	139	Next Page
113	Raise horizontal split	142	Slow Scroll
114	Lower horizontal split	144	Fast Scroll
115	Adjust window to show cursor	151	±Keyclick
116	±Cursor drag	155	±Block mode
117	±Insert mode	156	Block mode on
119	Home & Clear	157	Block mode off

Note

An Accessibility aid feature allows the modifier keys to remain in effect after they are released. A small icon in the status line indicates its state.

To enable: Press any modifier key five times.

To disable: Press and hold a modifier key while you press another key.

Compose Characters

The tables at the end of this manual describe how to compose characters for the Multinational, ISO Latin 1, ISO Latin 2, ISO Latin-Greek, and National Replacement character sets (NRCS) for a VT keyboard.

In the tables, column ...	Represents ...
▽	Characters to be composed.
3-□	A three-stroke key sequence beginning with the Compose key.
2-□	A two-stroke key sequence beginning with a non-spacing diacritical accent key.

Within the tables ...	Represents ...
(sp)	A space character.

Canadian-English, Danish, Dutch, Hebrew, Hungarian, Italian, Norwegian, Polish, Romanian, Russian, SCS, Turkish-F, Turkish-Q, UK, and US keyboards do not have non-spacing diacritical marks regardless of the character mode.

Compose Characters

**VGB10 compose characters, Zusammengesetzte zeichen,
Composición de caracteres, Caractères composés,
Composizione caratteri, Samengestelde tekens**

Table 1 Multinational Character Set

▽	3-□	2-□	▽	3-□	2-□
#	++		¶	P!	
@	AA		¹	1^	
²	2^		³	3^	
[((]))	
{	(-		})-	
«	<<		»	>>	
‘	¨ (sp)	¨ (sp)	μ	/U	
˘	` (sp)	` (sp)	•	.^	
˙	˙ (sp)	˙ (sp)			
^	^(sp)	^(sp)	~	~(sp)	~(sp)
¼	1 4		½	1 2	
ı	!!		ı	??	
£	L - L =		¥	Y - Y =	
©	CO C0		±	+ -	
ß	ss		α	XO X0	
\	// /<		¢	C / C	
	/^				

(continued on next page)

Compose Characters

Table 1 (Cont.) Multinational Character Set

▽	3-□	2-□	▽	3-□	2-□
§	SO S!		°	0^ ° (sp) * (sp)	° (sp)
ª	a _		•	o _	
á	´ a	´ a	Á	´ A	´ A
à	` a	` a	À	` A	` A
â	^ a	^ a	Â	^ A	^ A
ä	¨ a	¨ a	Ä	¨ A	¨ A
ã	~ a	~ a	Ã	~ A	~ A
à	a * a °		Å	A * A °	
æ	ae		Æ	AE	
ç	c ,		Ç	C ,	
é	´ e	´ e	É	´ E	´ E
è	` e	` e	È	` E	` E
ê	^ e	^ e	Ê	^ E	^ E
ë	¨ e	¨ e	Ë	¨ E	¨ E
í	´ i	´ i	Í	´ I	´ I
ì	` i	` i	Ì	` I	` I
î	^ i	^ i	Î	^ I	^ I
ï	¨ i	¨ i	Ï	¨ I	¨ I
ñ	~ n	~ n	Ñ	~ N	~ N
ó	´ o	´ o	Ó	´ O	´ O
ò	` o	` o	Ò	` O	` O
ô	^ o	^ o	Ô	^ O	^ O
ö	¨ o	¨ o	Ö	¨ O	¨ O
õ	~ o	~ o	Õ	~ O	~ O

(continued on next page)

Compose Characters

Table 1 (Cont.) Multinational Character Set

▽	3-□	2-□	▽	3-□	2-□
ø	o /		Ø	O /	
ú	´ u	´ u	Ú	´ U	´ U
ù	` u	` u	Û	` U	` U
û	^ u	^ u	Û	^ U	^ U
ü	¨ u	¨ u	Û	¨ U	¨ U
ÿ	¨ y	¨ y			

Specific, Spezifisch, Sspecifico, Spécifique, Specifica, Specifiek

▽	3-□	2-□	▽	3-□	2-□
œ	oe		Œ	OE	
ý	´ y	´ y	Ý	´ Y	´ Y
			ÿ	¨ Y	¨ Y

Table 2 ISO Latin (Latino, Latina) 1,

Specific, Spezifisch, Sspecifico, Spécifique, Specifica, Specifiek

▽	3-□	2-□	▽	3-□	2-□
NBSP	(sp)(sp)		,	''	
¬	¬,		-	--	
®	RO		-	_ ^	
¾	3 4		÷	- :	
×	x x		˙	˙˙	
¡	 #! ^		¨	¨ (sp)	¨ (sp)
þ	TH		Þ	th	
Đ	- D		đ	- d	

Compose Characters

Table 3 ISO Latin (Latino, Latina) 2

▽	3-□	2-□	▽	3-□	2-□
ä	¨ a	¨ a	Ä	¨ A	¨ A
ë	¨ e	¨ e	Ë	¨ E	¨ E
ö	¨ o	¨ o	Ö	¨ O	¨ O
ô	^ o	^ o	Ô	^ O	^ O
u°	* u	* u	U°	* U	* U
[']					
á	´ a	´ a	Á	´ A	´ A
c	´ c	´ c	C	´ C	´ C
é	´ e	´ e	É	´ E	´ E
í	´ i	´ i	Í	´ I	´ I
l	´ l	´ l	L	´ L	´ L
n	´ n	´ n	N	´ N	´ N
ó	´ o	´ o	Ó	´ O	´ O
r	´ r	´ r	R	´ R	´ R
s	´ s	´ s	S	´ S	´ S
ú	´ u	´ u	Ú	´ U	´ U
ý	´ y	´ y	Ý	´ Y	´ Y
z	´ z	´ z	Z	´ Z	´ Z
[^]					
c	∨ c	∨ c	C	∨ C	∨ C
d	∨ d	∨ d	D	∨ D	∨ D
e	∨ e	∨ e	E	∨ E	∨ E
l	∨ l	∨ l	L	∨ L	∨ L
n	∨ n	∨ n	N	∨ N	∨ N
r	∨ r	∨ r	R	∨ R	∨ R
s	∨ s	∨ s	S	∨ S	∨ S

(continued on next page)

Compose Characters

Table 3 (Cont.) ISO Latin (Latino, Latina) 2

∇	3-□	2-□	∇	3-□	2-□
t	∨ t	∨ t	T	∨ T	∨ T
z	∨ z	∨ z	Z	∨ Z	∨ Z

Table 4 ISO Latin-Greek, Latino-Griego, Latin-Grec, Latina-Greca

∇	3-□	2-□	∇	3-□	2-□
[ˈ]					
ι	ˆ ι	ˆ ι	I	ˆ I	ˆ I
υ	ˆ υ	ˆ υ	Υ	ˆ Υ	ˆ Υ
[ː]					
α	! α	! α	A	! A	! A
ε	! ε	! ε	E	! E	! E
η	! η	! η	H	! H	! H
ι	! ι	! ι	I	! I	! I
ο	! ο	! ο	O	! O	! O
υ	! υ	! υ	Υ	! Υ	! Υ
ω	! ω	! ω	Ω	! Ω	! Ω
[ˈ] + [ː]					
ι	ˆ ! ι	ˆ ! ι			
υ	ˆ ! υ	ˆ ! υ			

Compose Characters

Table 5 NRCS

National Replacement Character Sets, Zusammengesetzte Zeichen für Nationale Zeichensätze, Caracteres para nacionales de substitución, Caractères composés des jeux NRCS, Serie di caratteri sostitutivi nazionali, Nationale vervangingstekensets

Canadien (Français)	3-□	2-□	3-□	2-□
à	` a	` a		
â	^ a	^ a		
ç	, c			
è	` e	` e		
é	´ e			
ê	^ e	^ e		
î	^ i	^ i		
ô	^ o	^ o		
ù	` u	` u		
û	^ u	^ u		
<hr/>				
Danish				
#	+	+		
<hr/>				
Español				
~	~ (sp)		°	^ 0
£	L - L =		§	o s ! s
<hr/>				
Finnish				
#	+	+	é	´ e

(continued on next page)

Compose Characters

Table 5 (Cont.) NRCS

Français, Belgian, UK

	3-□	2-□	3-□	2-□
£	L -			
	L =			

Italiano

°	(sp) *			
	(sp) 0			

Norwegian

@	A A	#	+	+
---	-----	---	---	---

Portuguese

ã	a ~	~ a	Ã	A ~	~ A
õ	o ~	~ o	Õ	O ~	~ O
´	´ (sp)		^	^ (sp)	
`	` (sp)		´	´ (sp)	
~	~ (sp)				

Swedish

é	´ e		É	´ E	
ü	" u		Û	" U	

Suisse/Français, Schweizerisch/Deutsch

ê	^ e	^ e	è	` e	` e
î	^ i	^ i	ô	^ o	^ o
û	^ u	^ u	ù	` u	` u

Related Documentation

Refer to the *VGB10 Video Terminal Programmer Information*, EK-VGB10-RM for programmer information.

To order manuals, (in the USA) call toll-free: (800) 344-4825.

Service

How To Get Service

To find out more about hardware and software services:

In the United States:

Call 1-800-354-9000.

Worldwide:

Contact your local service office.