

This document was prepared and published by Educational Services Development and Publishing, Digital Equipment Corporation.

Installing and Using The VT1000 Video Terminal

Order Number EK-V1000-UG-002

Digital Equipment Corporation

First Edition, February 1990 Second Edition, June 1990

The information in this document is subject to change without notice and should not be construed as a commitment by Digital Equipment Corporation. Digital Equipment Corporation assumes no responsibility for any errors that may appear in this document.

The software described in this document is furnished under a license and may be used or copied only in accordance with the terms of such license.

No responsibility is assumed for the use or reliability of software on equipment that is not supplied by Digital Equipment Corporation or its affiliated companies.

Restricted Rights: Use, duplication, or disclosure by the U. S. Government is subject to restrictions as set forth in subparagraph (c) (1) (ii) of the Rights in Technical Data and Computer Software clause at DFARS 252.227-7013.

Copyright © by Digital Equipment Corporation 1990

All Rights Reserved.
Printed in Taiwan.

FCC NOTICE: The equipment described in this manual generates, uses, and may emit radio frequency energy. The equipment has been type tested and found to comply with the limits for a Class A computing device pursuant to Subpart J of Part 15 of FCC Rules, which are designed to provide reasonable protection against such radio frequency interference when operated in a commercial environment. Operation of this equipment in a residential area may cause interference, in which case the user at his own expense may be required to take measures to correct the interference.

AT&T and UNIX are trademarks of the American Telephone and Telegraph Company.

X Window System is a trademark of the Massachusetts Institute of Technology.

The following are trademarks of Digital Equipment Corporation:

| | | | |
|------------|----------------|--------------|---------------------|
| DEC | DECwindows | PDP | ThinWire |
| DECall | DECwriter | P/OS | ULTRIX |
| DECconnect | DIBOL | Professional | ULTRIX-32 |
| DECmailer | LA | Q-bus | UNIBUS |
| DECmate | LA50 | Q22-bus | VAX |
| DECnet | LA75 Companion | Rainbow | VAXstation |
| DECserver | LN01, LN03 | ReGIS | VMS |
| DECservice | LN03 PLUS | RSTS | VR150 |
| DECstation | LQP02 | RSX | VT, VT52, VT100 |
| DECsupport | MASSBUS | RT | VT220, VT320, VT420 |
| DECterm | MicroPDP | Scholar | VT1000 |
| DECUS | MicroVAX | SERVcenter | |

digital[™]

Contents

- About This Guide** xi

- 1 A Look at the Terminal**
- VT1000 Components 1
 - System Box 2
 - Monitor 2
 - Keyboard 3
 - Mouse 3
- X Window Sessions and Video Terminal Sessions 3
 - X Window System and DECwindows 3
- System Requirements 4
 - VMS Systems: LAT Protocol 4
 - UNIX and ULTRIX Systems: TCP/IP TELNET Protocol 4
- How the VT1000 Works 5
- VT1000 Terminal Highlights 6
 - Customizing Your Terminal 7
 - Compatibility with VT Series Terminals 7
 - Character Sets 7
- Programming the VT1000 Terminal 7

Installing Your VT1000 Video Terminal

2 Installing Your Terminal

| | |
|--|----|
| Site Preparation | 11 |
| Selecting a Location | 13 |
| Installation | 14 |
| Installing Memory | 21 |
| Installing the RAM Memory Controller Board | 24 |
| Installing the ROM Board | 28 |

3 Getting Started

| | |
|--|----|
| VT1000 Terminal Manager Window | 32 |
| Choosing the Display Language | 32 |
| Choosing the Correct Keyboard Type | 33 |
| Starting a Session on Your Host System | 35 |
| Starting a Video Terminal or X Window Session on a VMS System | 36 |
| Starting a Video Terminal or X Window Session on an ULTRIX or UNIX System | 41 |
| Starting a Video Terminal Session on the Serial Host Port | 47 |
| Ending a Session | 47 |

Using Your VT1000 Video Terminal

4 Using Windows

| | |
|--|----|
| DECwindows Differences | 51 |
| Before You Start | 52 |
| Using the Mouse | 52 |
| What Are Windows? | 53 |
| Using Windows | 54 |
| Selecting Windows | 55 |
| Moving Windows | 55 |
| Changing the Size of Windows | 56 |
| Shrinking Windows to Icons | 57 |
| Expanding Icons to Windows | 58 |

| | |
|--|-----|
| Stacking Overlapping Windows | 59 |
| Choosing Items from Pull-Down Menus | 59 |
| Supplying Information in Dialog Boxes | 60 |
| Moving and Changing Settings in a Dialog Box | 62 |
| Using Scroll Bars | 63 |
| | |
| 5 Using Video Terminal (VTE) Windows | |
| VTE Window Format | 66 |
| Clearing, Resetting, or Leaving the Session | 68 |
| Copying and Pasting Text | 69 |
| Host Synchronization Required | 70 |
| Selecting Text to Copy | 71 |
| Pasting Text | 71 |
| Using QuickCopy | 72 |
| Customizing the VTE Window | 72 |
| Displaying the Customize Menu | 73 |
| Saving and Recalling Settings | 74 |
| Changing Your VTE Window Settings | 75 |
| Changing Your VTE Display Settings | 78 |
| Changing Your VTE General Operating Features | 80 |
| Changing Your VTE Keyboard Features | 84 |
| Choosing National Replacement Character Sets | 86 |
| Printing from a Video Terminal Window | 87 |
| | |
| 6 Using the VT1000 Terminal Manager | |
| VT1000 Terminal Manager Window | 91 |
| Creating Sessions on a Host System | 93 |
| Creating a Video Terminal Window on a VMS System | 95 |
| Creating an X Window Session on a VMS System | 100 |
| Creating a Video Terminal Window or X Window Session on an ULTRIX or UNIX System | 102 |
| Creating a Video Terminal Window on the Host or Printer Port (VMS, ULTRIX, or UNIX) | 104 |
| Creating a TCP/IP X Window Session | 105 |
| Pausing or Ending Sessions | 106 |
| Pausing a Session | 106 |

| | |
|---|-----|
| Ending a Session | 108 |
| Customizing Your VT1000 Environment | 110 |
| Printing the Screen | 110 |

7 Customizing the VT1000 Terminal Manager

| | |
|---|-----|
| Displaying the Customize Menu | 113 |
| Saving and Recalling Settings | 114 |
| Changing Your Keyboard Settings | 115 |
| Choosing the Display Language | 118 |
| Changing Your Pointer and Mouse Settings | 119 |
| Changing Your Print Screen Settings | 120 |
| Changing Your Security Settings | 122 |
| Locking Your Customize Dialog Boxes | 125 |
| Activating Customize Password Security | 128 |
| Changing Your Window Settings | 129 |
| Controlling the Display of Messages | 132 |
| Changing Your Host Port or Printer Port Settings | 134 |
| Changing Your LAT Settings | 138 |
| Changing Your TCP/IP Settings (ULTRIX and UNIX Systems) | 142 |
| Changing Your TCP/IP Name Server Settings | 144 |
| Changing Your TCP/IP Routing Table Settings | 145 |
| Changing Your Font Path Settings | 147 |

8 The Keyboard

| | |
|-----------------------------|-----|
| LK401 Keyboard | 151 |
| Keyboard Dialect | 151 |
| Layout | 151 |
| Main Keypad | 152 |
| Editing Keypad | 155 |
| Numeric Keypad | 155 |
| Top-Row Function Keys | 156 |
| Data Processing Keys | 157 |
| Compose Characters | 158 |
| Indicator Lights | 158 |
| Audible Indicators | 159 |

| | |
|----------------|-----|
| Keyclick | 159 |
| Bell | 159 |

9 Typing Additional Characters

| | |
|---|-----|
| What Characters Can I Type? | 161 |
| Key Sequences with Nonspacing Diacritical Keys | 161 |
| How to Type a Character Using the Compose Character Key | 162 |
| How to Type a Character Using the Group Shift Key | 162 |
| Invalid Sequences | 163 |
| Canceling or Restarting a Key Sequence | 163 |
| Hexadecimal Key Sequences | 164 |

10 VT1000 VTE Programming Summary

| | |
|--|-----|
| Locator Device Commands | 169 |
| Enable Filter Rectangle (DECEFR) | 170 |
| Enable Locator Reports (DECELR) | 171 |
| Locator Report (DECLRP) | 172 |
| Request Locator Position (DECRQLP) | 174 |
| Select Locator Events (DECSLE) | 175 |
| Programming Summary | 176 |

11 Solving Problems and Getting Service

| | |
|-----------------------------|-----|
| Operating Problems | 183 |
| Power-Up Self-Test | 187 |
| Screen Error Messages | 187 |
| Digital Service | 188 |
| How To Get Service | 189 |

A Specifications

| | |
|-------------------------------------|-----|
| Site Planning | 190 |
| Environment | 191 |
| Electrical | 191 |
| Display (Monochrome Monitors) | 192 |
| LK401 Keyboard | 192 |

B Options and Documentation

| | |
|------------------------------|-----|
| Optional Memory Boards | 194 |
| Modems | 194 |
| Cables | 195 |
| Related Documentation | 195 |
| Ordering Information | 196 |

C Communication

| | |
|---|-----|
| Network Protocols | 197 |
| Serial Communication | 198 |
| Serial Communication Cables | 199 |
| Serial XON/XOFF Flow Control | 199 |
| Modems | 200 |
| Modem Connections and Disconnections | 200 |
| Break Function | 201 |
| Communication Connector Signals | 201 |
| Pin Signals for the Pointing Device Connector | 203 |
| Standards | 203 |

D System Management Tasks

| | |
|---|-----|
| Preparing the LAT Environment (VMS Systems) | 204 |
| Preparing the TCP/IP Environment (ULTRIX and UNIX Systems) .. | 205 |
| Running a Remote X Window Session on a VMS System | 214 |

Glossary

Index

Tables

| | | |
|------|---|-----|
| 9-1 | Keyboards with Diacritical Marks | 161 |
| 9-2 | Key Sequences for Additional Characters | 166 |
| 10-1 | Primary DA Alias Responses from the VT1000 | 182 |
| 10-2 | Control Function Requests (non-VT320) | 182 |
| 11-1 | Operating Problems | 183 |
| C-1 | 6-Pin DEC-423 Communication and Printer Interface Signals | 202 |
| C-2 | Pin Assignments for the Pointing Device Connector | 203 |

About This Guide

This guide is designed to help you install, operate, and maintain your VT1000 video terminal. The guide provides information on how to open X window or video terminal sessions on a VMS, ULTRIX, or UNIX system.

Who Should Use This Guide

This guide is for the installer and general user of the VT1000 video terminal. The guide also provides programmers with a summary of control functions they can use when writing applications for video terminal (VTE) windows.

Organization

This guide contains the following chapters and appendices:

- Chapter 1, “A Look at the Terminal,” provides an overview of the VT1000 terminal and its features.
- Chapter 2, “Installing Your Terminal,” describes how to install your terminal and connect it to a host computer system. The chapter also describes how to install optional RAM and ROM boards.
- Chapter 3, “Getting Started,” describes how to start a session on your host system. You can use the terminal with VMS, ULTRIX, or UNIX systems.
- Chapter 4, “Using Windows,” describes how to to manipulate windows, choose menu items, and edit text. The chapter also shows how to use the mouse.
- Chapter 5, “Using Video Terminal (VTE) Windows,” describes how to use video terminal (VTE) windows. VTE windows let you emulate Digital’s VT series of text terminals.

- Chapter 6, “Using the VT1000 Terminal Manager,” describes how to use the VT1000 Terminal Manager window. You use this window to begin and end sessions with a host system.
- Chapter 7, “Customizing the VT1000 Terminal Manager,” describes how to customize the terminal’s operating settings for your computing environment and personal preference.
- Chapter 8, “The Keyboard,” describes the function of the keyboard’s keys, bells, and indicator lights.
- Chapter 9, “Typing Additional Characters,” describes how to enter characters that do not appear as standard characters on your keyboard (for example, accented letters).
- Chapter 10, “VT1000 VTE Programming Summary,” provides programmers with a quick-reference summary of VT1000 programming control functions for video terminal (VTE) window applications.
- Chapter 11, “Solving Problems and Getting Service,” describes how to solve typical operating problems and directs you where to get more help.
- Appendix A, “Specifications,” lists VT1000 specifications.
- Appendix B, “Options and Documentation,” lists options, related documentation, and ordering information.
- Appendix C, “Communication,” provides technical information on communication with a host computer system. The appendix describes network protocols for LAT and TCP/IP connections, as well as serial communication.
- Appendix D, “System Management Tasks,” describes tasks for system managers to perform before installing and running the terminal. The appendix also describes how to run a remote X window session on a VMS system.
- The glossary defines new terms introduced in the text.

Conventions

The following conventions are used in this manual:

| | |
|------------------------------------|---|
| Mouse | Refers to any pointing device, such as a mouse, a puck, or a stylus. |
| MB1, MB2, and MB3 | MB1 indicates the left mouse button. MB2 indicates the middle mouse button. MB3 indicates the right mouse button. (The buttons can be redefined by the user.) |
| Keyboard keys | Keys or switches that are labeled appear in a <code>box</code> . Example: Press the <code>Return</code> key. |
| <code>Ctrl</code> <code>key</code> | For <code>Ctrl</code> key sequences, hold down <code>Ctrl</code> and press the other key. |
| Warnings | Provide information to prevent personal injury. |
| Cautions | Provide information to prevent damage to equipment or software. |
| Notes | Provide general information about the current topic. |
| Glossary entries | Appear in <i>italics</i> when first used in text. |

Note to the Reader

The screens and windows shown in this guide represent the latest information available at the time of publication. Some screens and windows may not exactly match those that appear on your terminal.

1

A Look at the Terminal

This chapter introduces you to the VT1000 video display terminal. The chapter provides an overview of the terminal and its basic operating features. The chapter also tells you where to look in this manual for more information about each feature.

The VT1000 lets you run X window applications on your computer system, including Digital's DECwindows software. The VT1000 also provides video terminal (VTE) windows that are compatible with VT series text terminals.

You can use the VT1000 with one or more computer systems. The VT1000 can work with computers that use the VMS, UNIX, or ULTRIX operating systems. You have several options for connecting your terminal to a computer.

You can use a mouse or keyboard to send information to the host system. You can print data displayed on the screen by connecting a printer to the VT1000 system box or by using printers connected to your host system.

VT1000 Components

The VT1000 terminal has four main components: a system box, monitor, keyboard, and mouse.

2 A Look at the Terminal

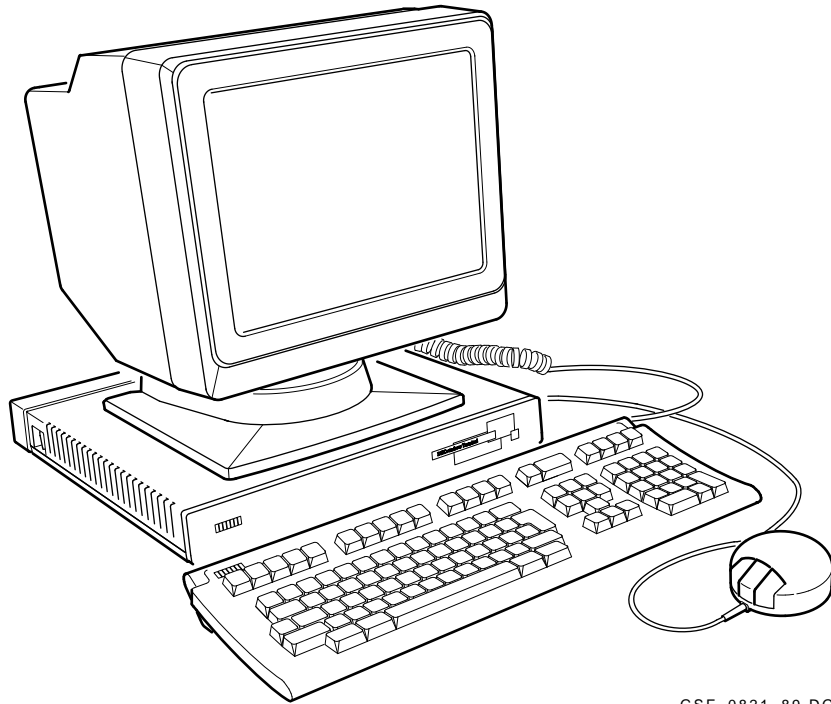

GSF_0821_89.DG

System Box

The VT1000 system box contains the terminal's logic and memory boards. It also provides the connectors for power, system communication, and other devices. A cover panel attaches to the rear of the system box to conceal the connectors and cables. The system box is 368 mm deep \times 394 mm wide \times 57 mm high (14.5 inches \times 15.5 inches \times 2.25 inches).

Monitor

The VT1000 comes with one of the following monochrome monitors:

- VR150 (380 mm/15 inch) with tilt-swivel stand
- VR262 (480 mm/19 inch) with stationary stand
- VR315 (380 mm/15 inch) with tilt-swivel stand
- VR319 (480 mm/19 inch) with tilt-swivel stand
- VRE01 (480 mm/19 inch) flat panel display

When connected to a host system, the monitor displays information you send to the host system and information the host system sends to you. For more information about your monitor, see your monitor's installation guide.

Keyboard

The LK401 keyboard has four groups of keys and two indicator lights. The keyboard cable connects to the system box. Chapter 8 describes the keyboard.

Mouse

The mouse is a three-button pointing device. You use the mouse to make selections from screen menus, enter data for graphics, or select points on the screen. The mouse connects to the system box. Chapter 4 describes how to use the mouse.

X Window Sessions and Video Terminal Sessions

You can use two types of sessions on your host computers:

X Window Session

To use an X window session, you log in to a host and use that host's X window software. In an X window session, you can use all the applications and utilities provided in the X Window System. For more information about Digital's X applications, see the *VMS DECwindows User's Guide* or the *ULTRIX Workstation (UWS) User's Guide*.

Video Terminal Session

You can use your VT1000 as a video text terminal. The VT1000 has a video terminal (VTE) window that lets you log in to a host as you would on a conventional video terminal. The VT1000's VTE window offers most of the features of Digital's VT320 text terminal with some enhancements.

You can open one X window session and several VTE sessions at the same time.

X Window System and DECwindows

The X Window System is a graphically oriented user interface that lets you display one or more windows on the screen. Each window can represent a different *software application* running on its own host system. For example, you could run a word processing application in one window and a spreadsheet application in another window. With windows, you can perform many tasks in an easy and efficient manner.

4 A Look at the Terminal

The X Window System was designed at the Massachusetts Institute of Technology. Digital's DECwindows software is based on and fully compatible with the X Window System.

System Requirements

You can use your terminal with the VMS, ULTRIX, and UNIX based systems.

VMS Systems: LAT Protocol

The VMS operating system is one of Digital's operating systems. To make network connections to a VMS host system, use the local area transport (LAT) protocol. LAT is a communications protocol for connecting to VMS host systems.

To open a video terminal (VTE) session: You can use any version of the VMS operating system.

To open an X window session: You must have VMS Version 5.3-1 or higher installed on your system, and your system manager must enable certain options (Appendix D).

UNIX and ULTRIX Systems: TCP/IP TELNET Protocol

The UNIX operating system was created by AT&T and is used throughout the computer industry. The ULTRIX operating system created by Digital is based on the UNIX operating system. To make network connections to a UNIX or ULTRIX host, you normally use the transmission control program/Internet protocol (TCP/IP) networking software. TCP/IP is the preferred communication protocol for UNIX-based systems.

The VT1000 uses the TCP/IP TELNET protocol to make network connections to UNIX-based host systems. TELNET is the TCP/IP protocol that lets terminals connect to host systems in a wide-area network.

To open a video terminal session: You can use any version of UNIX or ULTRIX.

To open an X window session: You can use any version of UNIX to open an X window session, as long as any X11R3 client is installed on that host. ULTRIX workstation (UWS) versions 2.1 and higher include an X11R3 client.

How the VT1000 Works

You can use the VT1000 with one or more computer systems. You have several options for connecting your terminal to a computer. You can connect the terminal directly to a computer through one of two serial ports, or you can connect the terminal indirectly through an Ethernet network using the ThinWire port.

The computer system you connect to is called the *host*. You can connect several VT1000 terminals to a single host or connect one VT1000 terminal to several hosts.

You use the keyboard and mouse to interact with applications on your system. You send data to the application by typing on the keyboard or selecting window options with the mouse. Data sent by the application appears as text or graphics on the screen. You can print text or graphics from the VT1000.

You can use a variety of host software applications on the VT1000. For example, your host may have applications for word processing, data entry, programming, or business graphics. Most applications involve interactive processing. This means the VT1000 immediately sends the information you enter from the mouse or keyboard to the host.

Applications use programming functions to perform many operations. The VT1000 can work with standard American National Standards Institute (ANSI) functions. See Chapter 10.

VT1000 Terminal Highlights

The VT1000 terminal is a four-piece desktop unit that provides many of the features of a workstation. The VT1000 provides you with the following features:

- A workstation-style display, resolution, keyboard, and mouse
- An X Window System desktop server for efficient interaction with DECwindows and X window applications
- A local window manager that lets you move and resize windows
- A local terminal manager that lets you create, manage, and delete connections to hosts
- A local video terminal (VTE) window that lets you use the VT1000 as a conventional video terminal
- Access to VMS, ULTRIX, and UNIX operating system software at the same time
- Serial interfaces for a keyboard and a mouse or tablet
- Two serial lines with DEC-423 connectors for serial host communication and printer support, like a traditional terminal
- A ThinWire Ethernet port to connect to an Ethernet network
- An optional RAM board that provides up to 3 megabytes of added memory storage

The RAM board is user installable.

Customizing Your Terminal

The VT1000 lets you check and control the settings of the terminal's operating features. You can

- Change individual feature settings.
- Recall factory-default settings or your own stored settings from memory.
- Make temporary changes for the current session or store new settings for all future sessions.

Chapter 7 describes how to customize your VT1000.

Compatibility with VT Series Terminals

The VT1000 can operate as a video text terminal when you want to log in to a host system as you would with a conventional video terminal. You can use the VT1000 as one of Digital's VT320, VT220, VT102, VT101, or VT100 text terminals. Chapter 5 describes the video terminal (VTE) window and how to use it.

Character Sets

When you use video terminal (VTE) windows, you can choose different character sets to match your computer system or software application requirements. You can choose from:

- Two 8-bit multinational character sets—DEC Multinational or the ISO Latin Alphabet No. 1 set of the International Standards Organization
- Several 7-bit national replacement character sets (NRCs) for Western European languages

Chapter 5 describes how to choose characters sets.

Programming the VT1000 Terminal

The VT1000 video terminal (VTE) windows emulate Digital's VT320 text terminal. The *VT320 Programmer Reference Manual* explains the control functions used to access the terminal's video terminal (VTE) window features. Chapter 10 of this user guide is a summary of VT1000 specific control functions and commands. Programmers use these functions in their applications.

Installing Your VT1000 Video Terminal

2

Installing Your Terminal

This chapter provides step-by-step instructions on how to:

- Prepare for installation.
- Unpack, inspect, and check the terminal's components.
- Connect your terminal to a monitor, mouse, and keyboard.
- Connect your terminal to a network.
- Turn on your terminal.
- Connect an optional printer, modem, or tablet.
- Install an optional memory board.

Carefully read all installation instructions before you turn on the power.

Site Preparation

Before you install your VT1000 video terminal, make sure your computer system has the necessary network hardware and system software to support the terminal. See your system manager to make sure these requirements are met.

For System Managers

System managers need to prepare the system for use with the VT1000 video terminal. Appendix D describes the required tasks.

Network Hardware Support

The VT1000 video terminal requires one of the following physical connections to connect to a host computer system:

ThinWire connector Lets the VT1000 operate with X window applications and multiple text terminal sessions, using either the LAT or TCP/IP network protocol. You must use the ThinWire connector to operate with X window or DECwindows software.

Serial line Lets the VT1000 connect to a single host or terminal server as a traditional text terminal.

System Software Support

The following table summarizes the system resources needed to open X window sessions or video terminal (VTE) sessions:

| Operation | Operating System | Communication Protocol |
|------------------------|---|--|
| Video terminal session | VMS Version 4.0 | LAT |
| | UNIX (any version) | TELNET (TCP/IP) |
| | ULTRIX (any version) UWS Version 2.2 | TELNET (TCP/IP) LAT |
| X window session | VMS Version 5.3-1 or higher | LAT |
| | UNIX (any version) | TCP/IP TFTP (UDP) for font service |
| | UWS Version 2.1 (includes ULTRIX Version 3.1) or higher | TCP/IP TFTP (UDP) for font service |

Selecting a Location

Use the following guidelines to select a good location for your terminal:

- Select a surface area that is large enough to hold your system box, monitor, keyboard, and mouse.
- Select a location near ac power outlets and communication connectors.
- Keep your terminal away from heaters, photocopiers, direct sunlight, and abrasive particles.
- Do not block the air vents on the sides of the system box or place the system box on its side. Blocking the air vents can cause the system to overheat.
- To avoid screen glare, select a place where bright light will not reflect off the monitor.
- Place your monitor so that the top line of the monitor display is at eye level.
- Keep the air well circulated, to prevent excess heat and dust from accumulating.
- Keep the temperature between 10° and 40° C (50° and 104° F), and the relative humidity between 10% and 95%.
- Keep the area clean. Do not place food or liquid on or near your terminal.

Installation

Unpack and check the contents of each carton.

1. Look for external damage on the shipping cartons, such as dents, holes or crushed corners.
2. Unpack the shipping cartons.

WARNING

If necessary, use two people to lift or move the monitor out of the shipping carton. The approximate weight of the monitor is

- **VR150 monitor (380 mm/15 inch): 16 kg (36 lb)**
 - **VR262 monitor (480 mm/19 inch): 18 kg (40 lb)**
 - **VR315 monitor (380 mm/15 inch): 13 kg (29 lb)**
 - **VR319 monitor (480 mm/19 inch): 27 kg (60 lb)**
 - **VRE01 monitor (480 mm/19 inch): 8 kg (15 lb)**
3. Make sure you have all the items shown in the following figure. Carefully inspect the components for shipping damage. If you have missing or damaged items, contact your sales representative and delivery agent.

CAUTION

If you received optional memory boards, do not remove them from the antistatic bag at this time. Static electricity can damage memory boards.

4. Save the empty shipping cartons and packing material for repacking, in case you move or relocate your terminal.

Install any optional memory first.

If you ordered additional memory for your terminal, go to the “Installing Memory ” section at the end of this chapter. You should install memory boards in the system box before proceeding.

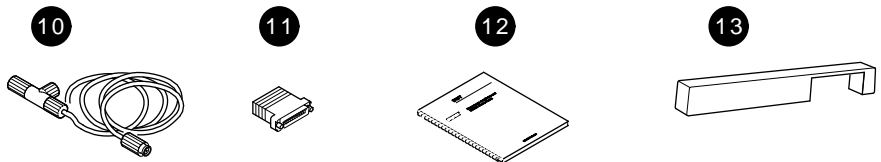
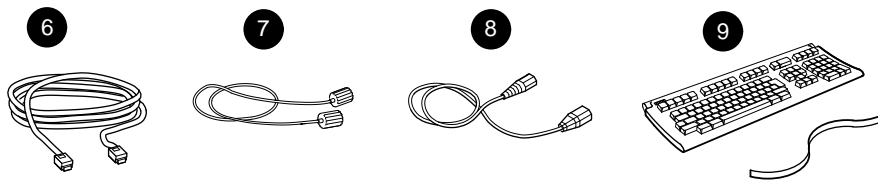
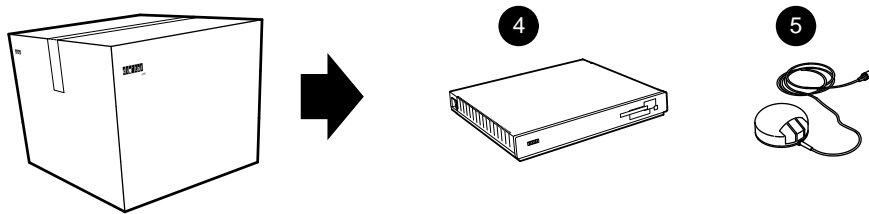
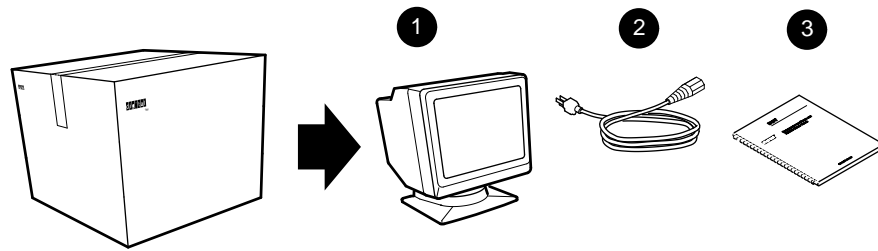

GSF_0822_89.DG

16 Installing Your Terminal

VT1000 Parts Checklist

- ① Monitor: VR150, VR262, VR315, VR319, or VRE01
- ② System box power cord
- ③ Monitor installation guide
- ④ System box
- ⑤ Mouse
- ⑥ DEC-423 communication cable
- ⑦ Monitor cable
- ⑧ Monitor power cord
- ⑨ Keyboard and legend strip
- ⑩ Ethernet cable and connector
- ⑪ EIA adapter (DEC-423 6-pin to 25-pin)
- ⑫ *Installing and Using the VT1000 Video Terminal*
- ⑬ Rear dress panel

Options (See “Installing Memory ”)

- Memory controller board (comes with one SIMM card preinstalled)
SIMM card(s)

NOTE

If you receive three power cords (a short one and two long ones), the second long power cord is not needed for this installation.

Place the system box on a level surface. Place the monitor on top of the system box.

Leave enough room at the rear of the system box and monitor for connecting cables.

WARNING

If necessary, use two people to lift or move the monitor.

Connect the cables to the system box.

Perform the following steps to connect cables and prepare the system box for use. The steps are keyed to the figures.

- 1 Connect one end of the monitor cable to the monitor and the other end to the system box.

If you have a VR262 or VRE01 monitor, attach the cable-holding fixture to the rear of the monitor before connecting the cable.

- 2 Set the monitor selection switch to match your monitor.

| Monitor | Switch Position |
|----------------|------------------------|
| VR150 | 1 |
| VR262 | 3 |
| VR315 | 5 |
| VR319 | 2 |
| VRE01 | 3 |

18 Installing Your Terminal

- ③ Connect the mouse or graphics tablet to the system box.
- ④ Connect the keyboard to the system box. Lower the keyboard's legs and install the legend strip for the top-row keys.
- ⑤ **Serial printer port:** If you have a printer or secondary host computer, connect the printer or host to the system box.
- ⑥ **Serial host port:** If you have a primary host computer or terminal server, connect the host or server to the system box.
- ⑦ Connect the ThinWire Ethernet cable's T-connector to the system box. Connect the other end of the cable to your local area network.

Serial Baud Rate For serial communication, the VT1000 line speed is initially set to a baud rate of 9600. Use the setting that matches your host system. To set the serial baud rate, see "Changing Your Host Port or Printer Port Settings" in Chapter 7.

- ⑧ Make sure the power switches on the system box and monitor are off (O). Then connect the long power cord to the system box and a grounded electrical outlet.
- ⑨ Connect the short power cord to the monitor and the system box.
- ⑩ Route all cables under the dress panel. Then push the dress panel onto the rear of the system box.
- ⑪ Turn the monitor's power switch on by pressing (|). Turn the system box's power switch on by pressing (|).

The keyboard sounds a bell tone, and a pie graph gradually fills in as the terminal performs its self-tests.

When the tests are done, the keyboard bell tone sounds again and the VT1000 Terminal Manager window appears.

Final steps . . .

- If you had problems with the installation, review the installation steps carefully. If the problem continues, refer to Chapter 11.
- This is a good time to set the brightness, contrast, and viewing angle of your monitor. See your monitor's installation guide for instructions.
- If you installed optional RAM memory, use the procedure at the end of this chapter to verify that the system recognizes the additional memory.

Otherwise, the installation procedure is complete. You can go to Chapter 3 to begin using your VT1000 video terminal.

Installing Memory

This section describes how to install memory boards in the system box. You can install

- Additional random access memory (RAM)
- A new read-only memory (ROM) board containing updated firmware

The VT1000 video terminal comes with 1 megabyte of RAM memory. You can add 1, 2, or 3 megabytes of optional RAM memory. Each megabyte of optional memory comes on a 1-megabyte single in-line memory module (SIMM) card. The SIMM cards install on the RAM memory controller board.

Unpack and check the contents of the box.



- **If you are installing additional RAM memory**, you receive a memory controller board with a 1-megabyte SIMM card installed. If you ordered more than 1 megabyte of RAM memory, you also receive one or two loose SIMM cards. Each SIMM card holds 1-megabyte of RAM memory. You will install the SIMM cards on the memory controller board later.
- **If you are installing a ROM board**, you receive a ROM board.

Carefully inspect the components for shipping damage. If you have any missing or damaged items, contact your sales representative and delivery agent.

CAUTION

The memory boards and the SIMM cards can be damaged by electrostatic discharge. Handle the memory board by its cover or strap. Handle the SIMM card by the side edges of the card.

Remove the system box cover.

1. Use a grounding wrist strap and an antistatic mat to perform the installation, if available. Otherwise, frequently touch the metal chassis of the system box during installation, to neutralize any existing static charges.
2. Turn the system box's  power switch off (O).
3. Turn the monitor's  power switch off (O).
4. Disconnect the two power cords from the rear of the system box.
5. Disconnect the monitor video cable from the rear of the monitor.
6. Remove the monitor from the top of the system box. You may need two people.
7. Release the top cover of the system box by pressing in the two push tabs on the side of the box with the power switch, as shown.
8. Slowly lift the top cover until you release the hinges on the other side of the box. Then lift the top cover completely off the system box.

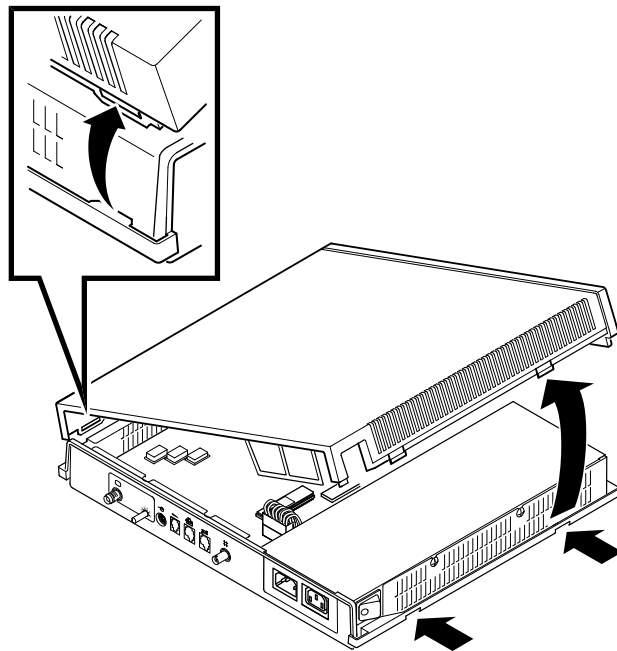

GSF_0839_89.DG

Identify the components in the system box.

There are four major components in the system box. The memory controller board is shown installed. SIMM cards install on the other side of the memory controller board.

If you are installing optional RAM memory, go to the next section.

If you are installing a ROM board, go to the section “Installing the ROM Board.”

System Box Components

- ① System logic board
- ② RAM memory controller board
- ③ ROM board
- ④ Power supply

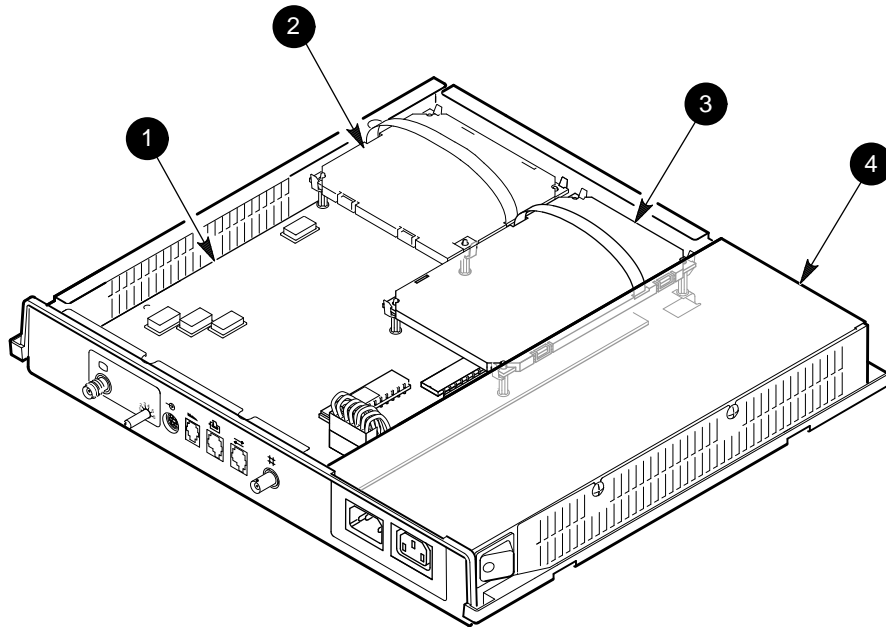

GSF_1362_89.DG

Installing the RAM Memory Controller Board

CAUTION

The memory controller board and the SIMM cards can be damaged by electrostatic discharge. Handle the memory controller board by its cover or strap. Avoid contact with any components or circuitry within the system box.

If your system already has a memory controller board, remove it.

1. Release the standoff clips by gently pushing each clip away from the board and lifting up on the edges of the board.
2. Grasp the strap of the memory controller board and pull up firmly to release the memory controller board connector from the system logic board.
3. Place the board on top of the power supply's metal cover, with the strap side down. You will use the metal cover as a work surface to perform the SIMM board installation.

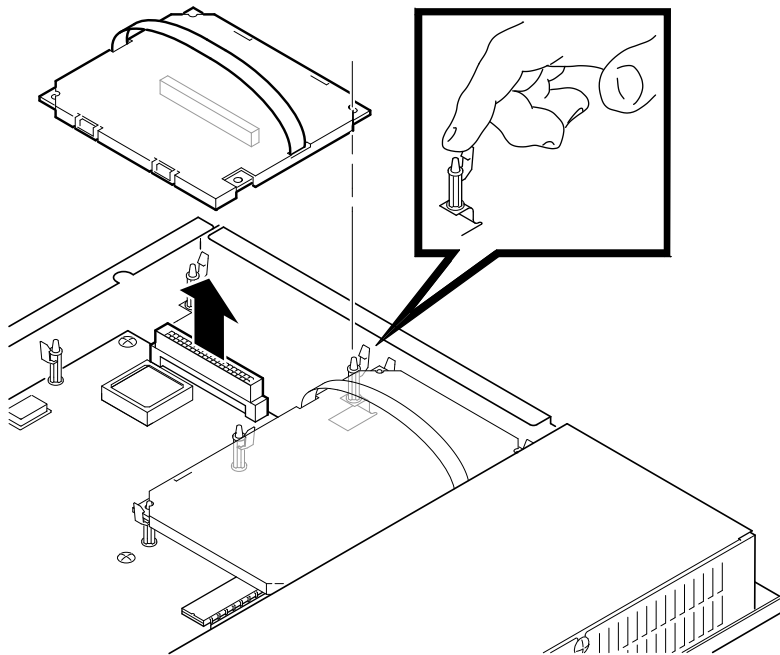

GSF_0957_89.DG

Install the SIMM cards on the memory controller board.

If you ordered 1 megabyte of memory, you can skip this procedure. If you ordered 2 or 3 megabytes of memory, you must install one or two SIMM cards on the memory controller board.

1. Remove the new memory controller board and the one or two small SIMM cards from the shipping bag.
2. Place them on top of the power supply's metal cover, with the strap side of the memory controller board facing down. Use the metal cover as a work surface to install the SIMM cards. This prevents electrostatic damage.
3. The memory controller board has one SIMM card preinstalled in the connector labeled 2MB. Install the next SIMM card in the connector labeled 3MB and the last SIMM card in the connector labeled 4MB, as follows:

CAUTION

SIMM cards can be damaged by electrostatic discharge. Handle the SIMM card by the side edges of the card. Avoid contact with the gold contact fingers on the card.

- a. Insert the SIMM card into the connector at a 45-degree angle. Face the components on the SIMM card toward the components on the memory controller board. Line up the center key slot on the SIMM card with the connector key on the memory controller board.
- b. Push down on the top of the SIMM card to securely seat the card in the connector.
- c. Raise the SIMM card into a standup position, until both sides of the card lock into the connector tabs.

26 Installing Your Terminal

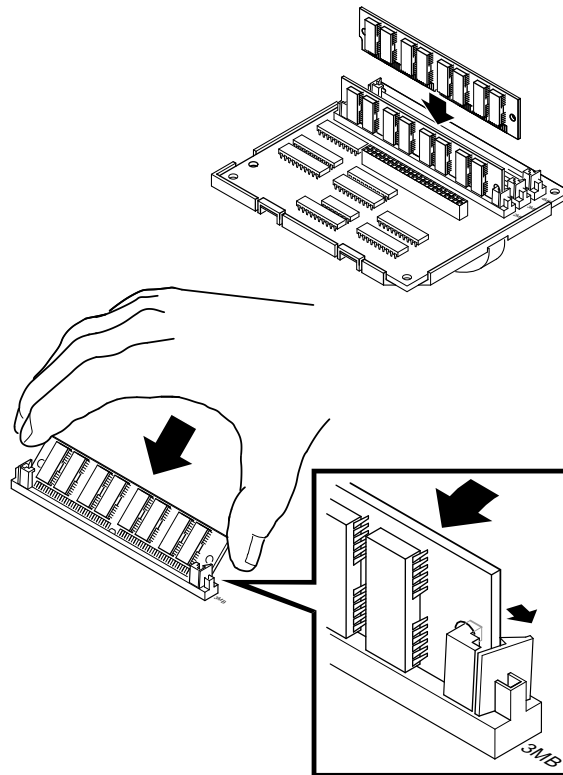

GSF_0840_89.DG

To remove the SIMM card: Gently push outward on the tabs at the sides of the connector. Tilt the SIMM card forward at a 45-degree angle, toward the edge of the RAM board. Grasp the edges of the SIMM card firmly and lift the card out of the connector.

Install the memory controller board into the system box.

1. Grasp the strap of the memory controller board.
2. Carefully place the board on top of its connector and standoffs in the system box. Use the standoffs as guides to align the connector on the board with the connector in the system box.
3. Press down firmly on the board and its edges to seat the connector and lock each of the four standoff clips.
4. Go to the section “Replace the system box cover.”

NOTE

If you have problems, recheck the installation procedures carefully. If the problem continues, contact Digital Customer Services.

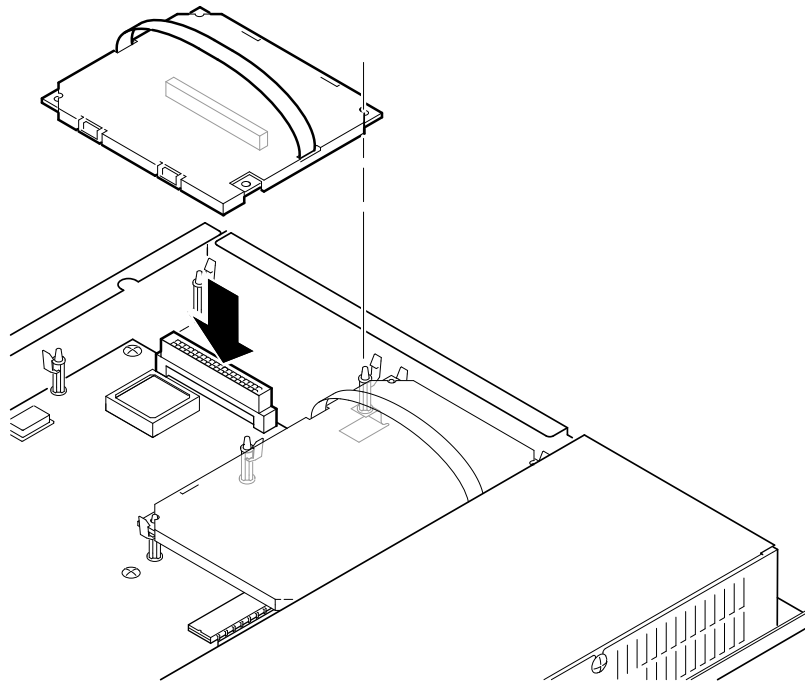

GSF_0842_89.DG

Installing the ROM Board

CAUTION

The ROM board can be damaged by electrostatic discharge. Handle the ROM board by its cover or strap. Also avoid contact with any components or circuitry in the system box.

Remove the old ROM board from your system box.

1. Release the standoff clips by gently pushing each clip away from the board and lifting up on the edges of the board.
2. Grasp the strap of the ROM board and pull up firmly to release the ROM board connector from the system logic board.
3. Place the board on top of the power supply's metal cover, with the strap side down.

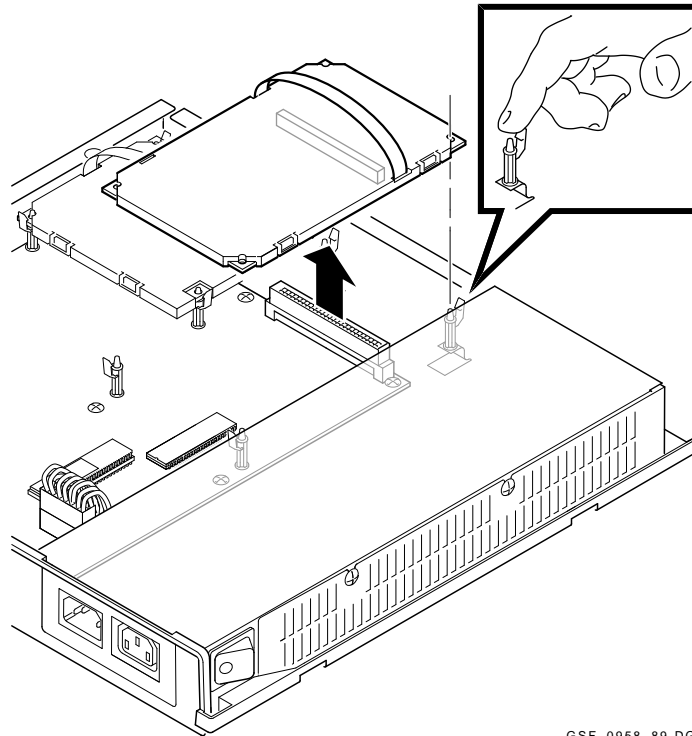

GSF_0958_89.DG

Install the new ROM board into the system box.

1. Remove the new ROM board from the box and shipping bag.
2. Grasp the strap of the new ROM board.
3. Carefully place the board on top of the ROM connector and standoffs in the system box. Use the standoffs as guides to align the connector on the board with the connector in the system box.
4. Press down firmly on the board and its edges to seat the connector and lock each of the four standoff clips.
5. Continue to the next section to replace the system box cover.

Replace the system box cover.

1. From the rear of the system box, place the left side of the top cover onto the hinge tabs in the left side of the system box.
2. Gently lower the right side of the top cover onto the system box. Make sure the power connector frame slides into the slot behind the power connectors.
3. Push down on the right side of the top cover until it snaps into the two push tabs, locking it in place.

After Installing the Memory Controller Board or ROM Board...

If you are installing the VT1000 terminal, go back to the beginning of this chapter and continue the installation procedure.

If not, perform the following steps:

1. Place the monitor on top of the system box. Leave enough room to connect cables on the rear of the system box and monitor.
2. Connect the two power cords to the rear of the system box.
3. Connect the monitor video cable to the rear of monitor.
4. Turn on the system box's power switch by pressing (|).
5. Turn on the monitor's power switch by pressing (|).

Verifying the Installation of Optional RAM Memory

The VT1000 Terminal Manager window should be displayed on your screen.

Verify that the number on the right side of the `Memory Remaining` scale displays the correct number of total megabytes in your system.

| Standard | + | Optional | = | Number Displayed |
|-----------------|----------|-----------------|----------|-------------------------|
| 1 megabyte | | 1 megabyte | | 2M |
| | | 2 megabytes | | 3M |
| | | 3 megabytes | | 4M |

NOTE

If you have problems, recheck the installation procedures carefully. If the problem continues, contact Digital Customer Services.

The installation procedure for optional memory is complete.

3

Getting Started

This chapter provides step-by-step procedures on how to begin using your terminal with a host computer. The chapter also introduces some of the VT1000 screens and menus.

If you are unfamiliar with using windows and a mouse, you may want to read the information in Chapter 4 before continuing.

Before you start, you should set the terminal to use the desired display language and keyboard type. By default, the terminal uses the English language and the North American keyboard type.

You can use your VT1000 with the VMS, ULTRIX, or UNIX operating systems. You can open two types of sessions on these systems—a video terminal session or X window session.

The chapter includes sections on:

- VT1000 Terminal Manager window
- Choosing the correct display language
- Choosing the correct keyboard type
- Opening a session on a VMS host system
- Opening a session on a UNIX or ULTRIX host system
- Ending a session

VT1000 Terminal Manager Window

When you turn on the terminal, it displays the VT1000 Terminal Manager window after running some self-tests. You use the VT1000 Terminal Manager window to start every session. The menu bar of this window contains the names of four pull-down menus: Session, Create, Customize, and Print Screen.

In this chapter, you will use the Session menu. Chapter 6 provides more details on how to use the VT1000 Terminal Manager. Chapter 7 describes how to customize the VT1000 Terminal Manager for your working environment.

Choosing the Display Language

You can display the VT1000 Terminal Manager window, system messages, and other menus in English, French, or German. The display language is initially set to English.

To change the display language:

1. Turn on the terminal. The VT1000 Terminal Manager window appears.
2. Point to the **Customize** menu name in the VT1000 Terminal Manager's menu bar. Click and hold MB1 to pull down the Customize menu.

3. In the Customize menu, drag the pointer to the **Language . . .** menu item. Release MB1. The Customize Language dialog box appears.

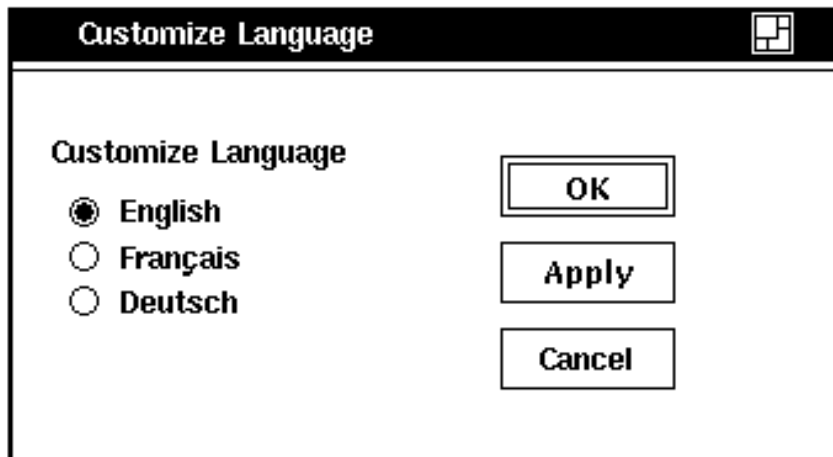

GSF_1047_89.RAGS

4. In the Customize Language dialog box, click on the button next to your language choice.
5. Click on the **OK** button to record your choice and dismiss the Customize Language dialog box.
6. Save your setting so you do not have to enter it each time you turn on the terminal.
 - Pull down the **Customize** menu from the VT1000 Terminal Manager's menu bar.
 - Choose the **Save Current Settings** menu item.

Choosing the Correct Keyboard Type

The VT1000 has many keyboard types for different languages and dialects. The terminal is initially set to work with the North American/United Kingdom keyboard. If you have another keyboard, you must change the setting.

To change the keyboard type:

1. Turn on the terminal. The VT1000 Terminal Manager window appears.

34 Getting Started

2. Point to the **Customize** menu in the VT1000 Terminal Manager's menu bar. Click and hold MB1 to pull down the Customize menu.
3. In the Customize menu, drag the pointer to the **Keyboard . . .** menu item. Release MB1. The Customize Keyboard dialog box appears.

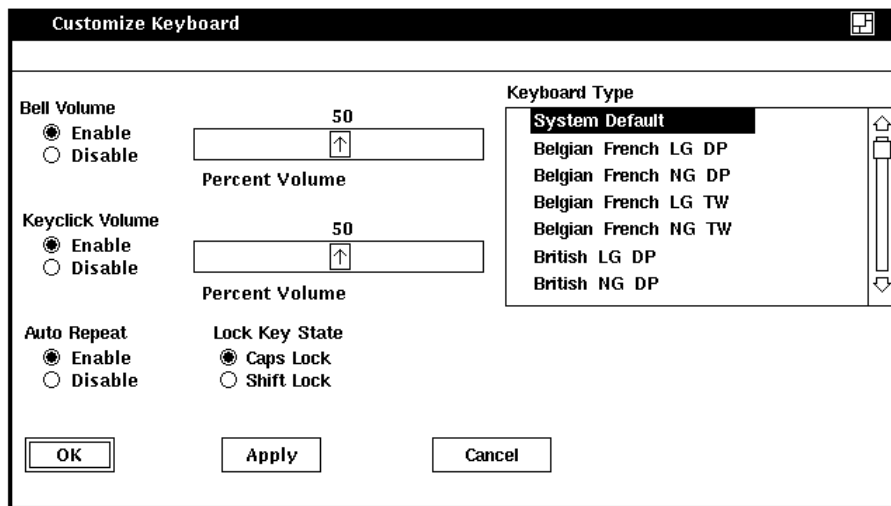

GSF_1046_89.RAGS

4. Turn the keyboard upside down and look for a label that specifies the model number. The model number should be in a format similar to LK401-xx or nn-nnnnn-xx. Use the xx value to choose your keyboard type from the Keyboard Type scroll box.

For example, if you have a British keyboard and the model number is LK401-AA, you choose LK401-AA British. (See Chapter 6 for details.)

5. In the Keyboard Type scroll box, click on the arrows until the keyboard you want appears.
6. Click on the correct keyboard entry.
7. Click on the **OK** button to record your choice and dismiss the Customize Keyboard dialog box.

8. Save your setting so you do not have to enter it each time you turn on the terminal.
 - Pull down the **Customize** menu from the VT1000 Terminal Manager's menu bar.
 - Choose the **Save Current Settings** menu item.

Starting a Session on Your Host System

You can use your terminal to open sessions on the VMS, ULTRIX, or UNIX operating systems.

You can run two types of sessions on a host computer with your terminal:

Video Terminal Sessions

You can use your VT1000 as a video text terminal. The VT1000 has a video terminal (VTE) window that lets you log in to a host as you would on a conventional video terminal. The VT1000's VTE window offers the features of Digital's VT320 terminal with some enhancements.

X Window Sessions

To use an X window session, you log in to a host and use that host's X window software. In an X window session, you can use all the applications and utilities provided in the X Window System.

You can run an X window session and a VTE session at the same time. The X window session appears in one window, while the VTE session appears in another. You can only run one X session at a time. You can run several VTE sessions at a time.

The following sections show you how to:

- Start a video terminal or X window session on a VMS system.
- Start a video terminal or X window session on an ULTRIX or UNIX system.
- Start a video terminal session using the serial host port.

Starting a Video Terminal or X Window Session on a VMS System

This section describes how to start a video terminal (VTE) or an X window session on a VMS host system, using a local area transport (LAT).

If you are using the VT1000 for the first time, you will need to enter one or more LAT group codes to begin either type of session. If you want to begin an X window session, you will also need to enter a LAT font path.

Your system manager can provide you with the group codes and font path for your network.

1. Turn on the terminal. The VT1000 Terminal Manager window appears.
2. To connect to a host or service on the network, you need to enter and save one or more LAT group codes in the terminal's memory. If you have already entered the group codes, go to step 6.

Point to the **Customize** menu name in the VT1000 Terminal Manager's menu bar. Click and hold MB1 to pull down the Customize menu.

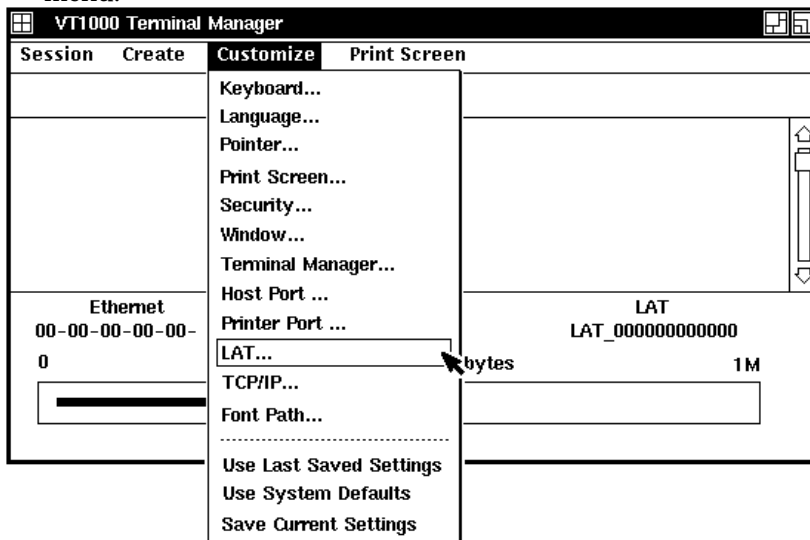

GSF_1710_89.RAGS

3. Drag the pointer to the **LAT . . .** menu item. Release MB1. The Customize LAT dialog box appears.

4. Enter a group code into the Customize LAT dialog box.
 - Use your keyboard to enter the group code into the text entry field.
 - Click on the **Add** button. The new group code appears in the Group Codes scroll box.
 - Repeat this procedure for each group code you want to add.
 - Click on the **OK** button to dismiss the Customize LAT dialog box.

38 Getting Started

5. Save your group code(s) so you do not have to enter them each time you turn on the terminal.
 - Pull down the **Customize** menu from the VT1000 Terminal Manager's menu bar.
 - Choose the **Save Current Settings** menu item.
6. If you want to begin an X window session, you need to enter and save a LAT font path. Some X applications require special character fonts to run properly. A font path lets the terminal access these character fonts from a host. If you have already entered a font path, go to step 9.

Pull down the Customize menu and choose the **Font Path . . .** menu item. The Customize Font Path dialog box appears.

7. Enter a font path into the Customize Font Path dialog box.
 - The LAT Font Path text entry field already has the word `ROM` entered. Enter a comma (,) followed by a font host name and two colons.
For example:

```
|ROM,BETA::  
-----
```

- Click on the **OK** button to dismiss the Customize Font Path dialog box.

You may have to wait several minutes before the message `Set font path succeeded` appears in the Messages area of the VT1000 Terminal Manager window. Sometimes it takes a few minutes for the terminal to receive the message identifying the font path host. The terminal retries every 30 seconds for 2.5 minutes. If the wait is too long, your system manager may be able to increase the host's multicast message frequency.

8. Save the font path so you do not have to enter it each time you turn on the terminal.
 - Pull down the Customize menu.
 - Choose the **Save Current Settings** menu item.
9. Point to the **Create** menu name in the VT1000 Terminal Manager's menu bar. Click and hold MB1 to pull down the Create menu.

10. To begin a VTE session, choose the **LAT Terminal Window . . .** menu item. The LAT Terminal Window Service Select dialog box appears.

To begin an X window session, choose the **LAT X Session . . .** menu item. The LAT X Session Service Select dialog box appears.

The two dialog boxes are similar. Here is the LAT Terminal Window Service Select dialog box:

11. Choose a host system and connect to it.

The names of the hosts you can access appear in the scroll box at the top of the dialog box. The host names should correspond to the group codes you have entered.

| Step | Result |
|---|--|
| 1 Find the name of the host you want to log in to. If necessary, click on the scroll bar to display more names. | Each time you click on the scroll bar, the scroll box displays more host names if available. |

| Step | Result | |
|---|---|--|
| NOTE | | |
| You may have to wait several minutes before the host you want appears. Click on the Update Known Services button to update the scroll box. If the wait is too long, see your system manager. | | |
| 2 | Click on the name of the host you want to log into. | The host name becomes highlighted in the scroll box and appears in the text entry field at the bottom of the window. |
| 3 | Click on the Add button. | The host name is added to the Preferred Services scroll box. You can add up to 4 hosts that you frequently log in to. |
| 4 | Click on the Save button. | The VT1000 saves the host names you added to the Preferred Services scroll box, so you do not have to enter them each time you turn your terminal on. |
| 5 | In the Preferred Services scroll box, click on the host you want to connect to. | The host is selected for connection. |
| 6 | Click on the Connect button. | A video terminal (VTE) window or X window login prompt appears. You may have to press the <code>[Return]</code> key several times before the login prompt appears. |

- Log in to the VTE host or X window session with the same username and password you use for video terminal sessions. After you log in to an X window session, the host-based session manager starts up.

Starting a Video Terminal or X Window Session on an ULTRIX or UNIX System

This section describes how to start a video terminal (VTE) session or an X window session on a UNIX or ULTRIX host system, using TCP/IP TELNET or TCP/IP.

If you are using the VT1000 for the first time, you need the following information before you begin a session:

- An IP address to assign to your terminal
- One or more names or IP addresses for the host(s) you want to connect to
- A font path file (for X window sessions only)

Your system manager can provide you with the IP addresses and a pointer to a font path file.

1. Turn on the terminal. The VT1000 Terminal Manager window appears.
2. Determine if you have to assign an IP address to your terminal.
 - If BOOTP address resolution is available on your system, your terminal can determine its own IP address at power-up. Ask your system manager. If BOOTP is available, you can go to step 8.
 - If BOOTP is not available, continue with step 4 to enter your terminal's IP address.
3. Point to the **Customize** menu name in the VT1000 Terminal Manager's menu bar. Click and hold MB1 to pull down the Customize menu.

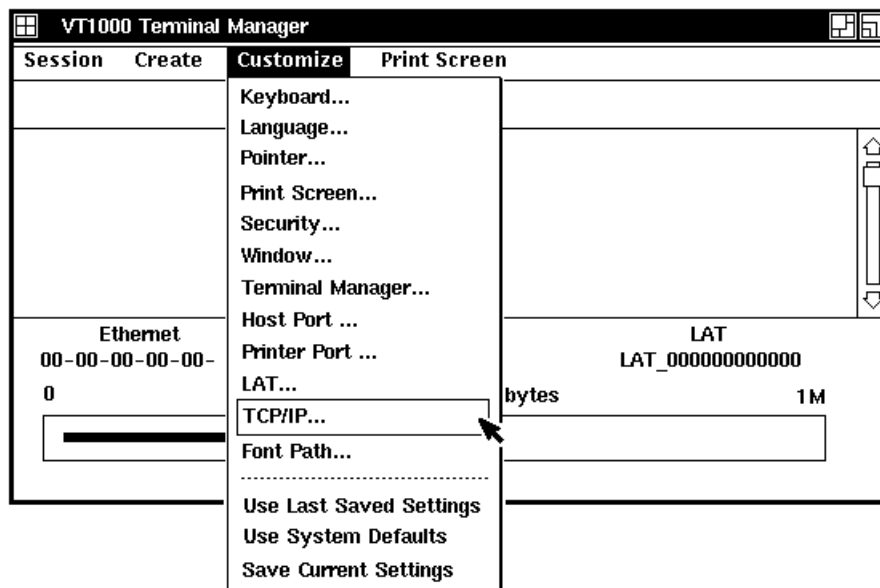

GSF_1715_89.RAGS

4. Drag the pointer to the **TCP/IP . . .** menu item. Release MB1. The Customize TCP/IP dialog box appears.

5. Enter an IP address and subnet mask.
 - Enter your terminal's IP address into the VT1000 IP Address (manual) text entry field.
 - Enter your IP subnet mask into the IP Subnet Mask text entry field.
 - Click on the **OK** button to dismiss the Customize TCP/IP dialog box.
6. Save your IP address and subnet mask so you do not have to enter them each time you turn on the terminal.
 - Pull down the **Customize** menu from the VT1000 Terminal Manager window.
 - Choose the **Save Current Settings** menu item.
7. **If you are starting a video terminal (VTE) session, go to step 11.**
If you are starting an X window session, perform the following steps to enter and save a font path in the VT1000 memory. If you have already entered the font path, go to step 11.

Some applications require special character fonts to run properly. A font path lets the VT1000 access these character fonts. You need to enter and save a font path in the terminal's memory. Your system manager can provide the font path for your VT1000.

To enter a font path, pull down the Customize menu and choose the **Font Path . . .** menu item. The Customize Font Path dialog box appears.

8. Enter a font path into the Customize Font Path dialog box.
 - Click on the **TFTP Font Path** button under the Font Path Selection title.
 - The word `ROM` is already entered in the TFTP Font Path text entry field. Enter a comma (,) a font host name or IP address, and a font file specification. See your system manager for the information to enter, if needed.
For example:

```
|ROM,123.45.67.89:/vt1000/100dpi/fonts.dir  
-----
```
 - Click on the **OK** button to dismiss the Customize Font Path dialog box. A message appears in the Terminal Manager window indicating the font path is being set.

9. Save the font path so you do not have to enter it each time you turn on the terminal.
 - Pull down the **Customize** menu from the VT1000 Terminal Manager's menu bar.
 - Choose the **Save Current Settings** menu item.
10. Pull down the **Create** menu from the VT1000 Terminal Manager's menu bar.

11. Choose the **TELNET Terminal Window . . .** menu item. The TELNET Terminal Window Host Select dialog box appears.

12. Under the **IP Address and optional host name** title, enter the IP address(es) or names of the host(s) you want to connect to. If your system has Name Servers, only names are needed. Ask your system manager.

- Click on one of the text entry fields under the IP Address and optional host name title. A text cursor appears.
- Enter the name or IP address of the host you want to connect to. Your system manager can provide you with IP addresses or names for the hosts on your network.
- Click on the **Save** button to save the information you enter, so you do not have to enter them each time you turn the terminal on.
- Click on the button next to the name of the host you want to connect to.

13. Click on the **Connect** button. A video terminal (VTE) window appears.

14. Log in to the host as you would on a conventional video terminal.

15. **If you want to run an X window application:**

- Enter the appropriate commands to enable your terminal to run an X window application:

If you are using the C-shell

```
% setenv DISPLAY your_terminal's_IP_address:0
```

If you are using the Bourne or Korn shell

```
$ DISPLAY=your_terminal's_IP_address:0  
$ export DISPLAY
```

- Begin an X window application by entering the appropriate command. For example, the following command starts a DECterm application:

```
$ dxterm
```

- You can also run the DECwindows session manager from your ULTRIX host by entering one of the following commands:

For UWS Version 2.1

```
$ dxsession -d your_terminal's_IP_address:0
```

For UWS Version 2.2

```
$ dxsession
```

Starting a Video Terminal Session on the Serial Host Port

This section describes how to start a video terminal (VTE) session on a VMS, UNIX, or ULTRIX host system if you use the serial host port.

1. Turn on the terminal. The VT1000 Terminal Manager window appears.
2. Point to the **Create** menu name in the VT1000 Terminal Manager window. Press and hold MB1 to pull down the Create menu.
3. Drag the pointer to the **Terminal Window on Host Port** menu item. Release MB1. A video terminal (VTE) window appears.
4. Press the Return key until the login prompt appears.
5. Log in to the host as you would on a conventional video terminal.

Ending a Session

You can end a session at any point, by choosing the Quit menu item from the Session menu of either the VT1000 Terminal Manager or the remote session manager. In both cases, choosing Quit returns the terminal to its initial start-up state.

End a session only after completing your work. When you end a session, the terminal:

- Terminates all host connections.
- Deletes all windows on the screen.
- Performs a complete software reset.
- Displays the VT1000 terminal manager window.

To end your session:

1. Point to the **Session** menu name in the VT1000 Terminal Manager's menu bar. Press and hold MB1 to pull down the menu.

48 Getting Started

2. Click on the **Quit** menu item. A dialog box appears, asking you if you really want to end the session.
 - To end the session, click on the **Yes** button.
 - To remain in the session, click on the **No** button.

Using Your VT1000 Video Terminal

4

Using Windows

This chapter describes how to use and manipulate VT1000 windows.

The chapter includes sections on:

- Using the mouse
- What are windows
- Selecting and manipulating windows
- Choosing items from pull-down menus
- Supplying information in dialog boxes
- Using scroll bars

DECwindows Differences

The windowing features of the VT1000 Terminal Manager are a subset of the features available in the DECwindows window manager. The following features of the DECwindows window manager are not available:

- Ability to lock stacked windows in place
- Animation of icons shrinking or expanding
- Control of icon positions in the icon box
- Icon box pop-up menu
- Ability to control which window gets input focus when you expand icons (The expanded icon automatically gets input focus.)

Before You Start

When you work with windowing applications, you use your mouse to perform many operations—from making menu selections to manipulating windows on the screen.

Using the Mouse

Your mouse lets you move quickly and easily through windowing applications. You simply point to an object on your screen and click a button. The mouse has three buttons:

- MB1 (mouse button 1) on the left
- MB2 in the middle
- MB3 on the right

This button arrangement normally suits right-handed users. If you are left-handed, you can reverse the position of MB1 and MB3 by changing the **Button Arrangement** setting in the Customize Pointer dialog box (Chapter 7).

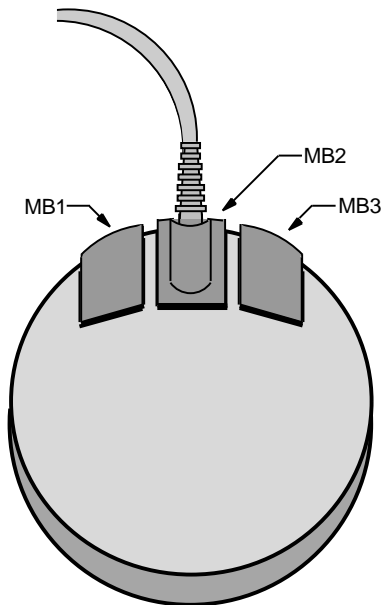

ZK-0250A-GE

In X window applications, you can perform six basic actions with the mouse.

| | |
|---------------------|---|
| Point | Move the mouse on your desk. This moves the cursor to where you want the next action to occur. |
| Click | Quickly press and release MB1. You should hear and feel a faint click. |
| Press | Point to a menu name or other item where you want the action to occur. Without moving the mouse, press and hold MB1. If you are pointing at a menu name, pressing MB1 pulls down a menu and keeps it down until you release MB1. |
| Drag | Press and hold MB1, move the pointer, and release MB1. For example, you drag a window outline to move it to another place on your screen. To cancel a drag in progress, click MB3 before releasing MB1. If you are displaying a pull-down menu, cancel the drag by moving the pointer outside the menu. |
| Double click | Point to the object and click MB1 twice in quick succession. |
| Shift click | Point to the object. Press and hold the [Shift] key and click MB1. Then release the [Shift] key. |

You will get a chance to practice these movements when you open your first session.

What Are Windows?

A window is an area on your screen that represents all or part of an application. You can use windows to view several applications at once. You can move windows on the screen, organizing information for easier use. The video terminal (VTE) window is one of several windows available on your VT1000 terminal.

54 Using Windows

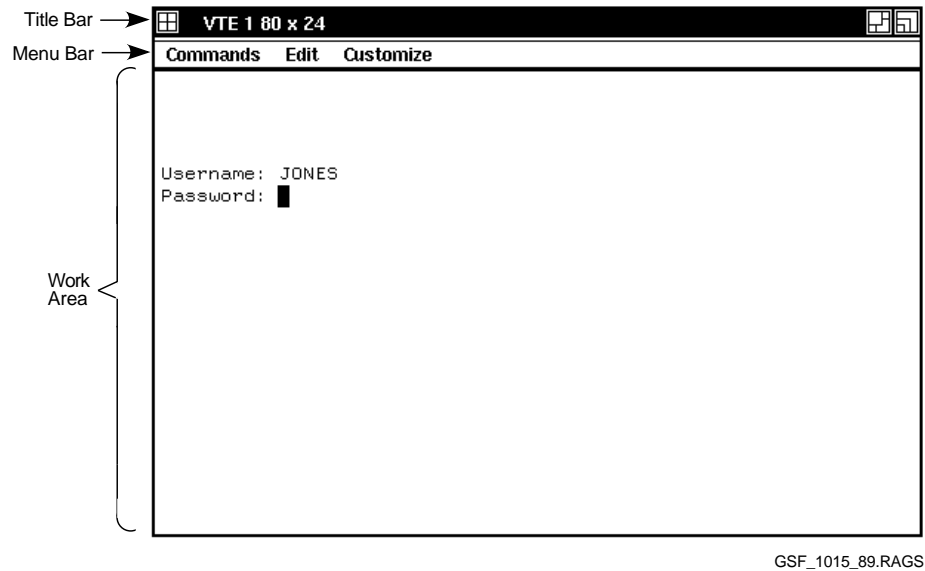

- The **title bar** at the top identifies the window.
- The **menu bar** below the title bar lets you choose the application's commands.
- The **work area** displays the application's text and graphics.

Using Windows

This section describes the basic techniques for manipulating windows, including

- Selecting windows
- Moving windows
- Changing the size of windows
- Shrinking windows to icons and reexpanding them
- Working with stacked windows

Selecting Windows

The VT1000 video terminal lets you open several windows on the screen. When you have several windows open at one time, you give one window *input focus* by selecting it. Only one window can have input focus at a time. Input focus allows you to enter information from your keyboard or mouse into the window.

Window with Input Focus



Window without Input Focus

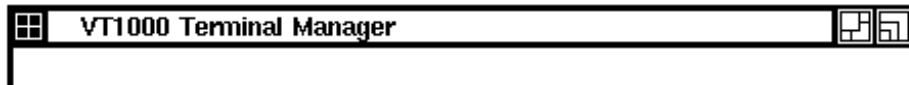

GSF_1024_89.RAGS

To select a window:

1. Point to any location in the window or title bar.
2. Click MB1.

The window's title bar becomes highlighted to indicate it has input focus. Any text you type appears in this window, if your application allows text entry. When you select another window, the first window's title bar is no longer highlighted.

Moving Windows

You use the title bar to move the windows on your screen. Windows can overlap one another. If one window partially obscures another, you may want to arrange them so that each is completely visible.



GSF_1025_89.RAGS

To move a window:

1. Point to the window's title bar.
2. Press and hold MB1.
An outline of the window appears.
3. Drag the pointer to the new location.
4. Release MB1.

If the window was partially obscured by other windows, it pops to the top of the stack of windows and is given input focus.

To cancel a window-moving operation in progress, click another mouse button before releasing MB1. The outline disappears, and the window does not move.

Changing the Size of Windows

You can make windows larger, to display more information. Or you can make windows smaller, so you can view several applications. To change a window's size, you use the window's resize button.



GSF_1026_89.RAGS

To change the size of a window:

1. Point to the window's resize button.

2. Press and hold MB1.

The pointer changes into a resize cursor.

3. Drag the resize cursor until the window is the size you want.

To make the window larger, drag the resize cursor beyond the window border and release MB1.

To make the window smaller, drag the resize cursor beyond the window border and then back in.

4. Release MB1.

You can change the size of a window in one dimension (height or width) or in both dimensions.

- To change the size in one dimension, drag the resize cursor across one border of the window. As long as you cross only one border, the outline that follows the resize cursor changes in only one dimension.
- To change the size in both dimensions, drag the resize cursor across two adjacent borders.
- If you drag the resize cursor through two *opposite* borders, the first border you crossed returns to its original location and the other border becomes an outline that follows the resize cursor.

To cancel a window-resizing operation in progress, click another mouse button before releasing MB1. The outline disappears, and the window remains at its original size.

Shrinking Windows to Icons

When you start an application, its icon appears in the Icon Box. The Icon Box is a short window that stretches across the top of the screen. While the application is on your screen, its icon is dimmed.

If you want to run an application in the background, you can shrink its window to an icon. The icon in the Icon Box becomes bold.

Shrinking a window frees up space on your screen to run other applications. The application continues to run in memory and remains easily accessible, but does not take up any room on your screen. The application's processes continue to execute while the application is stored as an icon.

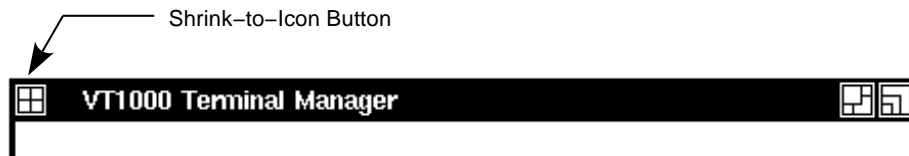

GSF_1027_89.RAGS

To shrink a window to an icon:

1. Point to the window's shrink-to-icon button.
2. Click MB1.

The window closes and its bolded icon appears in the Icon Box.

You cannot shrink the Icon Box to an icon.

When you start and stop many applications, the Icon Box may develop gaps where icons used to be. You can rearrange the remaining icons.

To rearrange icons in the icon box:

1. Point to the icon box's shrink-to-icon button.
2. Click MB1.

The icons are rearranged to remove gaps and overlaps.

Expanding Icons to Windows

When you expand an application's icon, you open a window for that application. If you already have more than one window open, the new window is placed on top of the stack of overlapping windows. If the window accepts text entry, the window is given input focus.

To expand an icon to a window:

1. Point to the icon in the Icon Box.
2. Click MB1.

Stacking Overlapping Windows

You do not have to move a window to see its entire contents. When windows are overlapping, you can push the top window to the bottom of the stack by clicking on the window's push-to-back button. The next window is then fully visible.

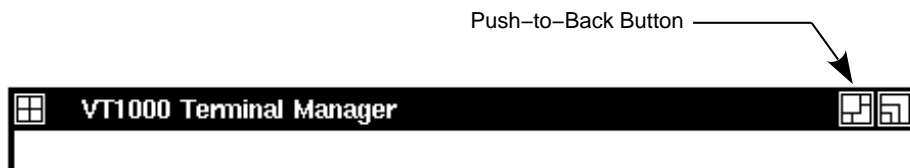

GSF_1029_89.RAGS

To push the top window to the bottom of a stack:

1. Point to the top window's push-to-back button.
2. Click MB1.

If you try this repeatedly with three or more windows, you can see that the windows cycle through the stacking order. The lower windows move up one position in the stack each time you move the top window to the bottom of the stack.

Choosing Items from Pull-Down Menus

The menu bar of a window lists the names of menus for that application. When you press MB1 on a menu name, the menu is pulled down from the menu bar.

Some pull-down menus list commands. Others list the names of items you can work with. If a menu item is followed by three periods (. . .), a dialog box will be displayed when you choose that item.

To choose an item from a pull-down menu:

1. On the menu bar, point to the menu name you want to display.
2. Press and hold MB1 to highlight the menu name and pull down the menu.
3. While holding MB1, drag the pointer to the menu item.
4. Release MB1.

If you change your mind while looking at a pull-down menu, drag the pointer outside the menu and release MB1. The menu disappears and no action is taken.

Supplying Information in Dialog Boxes

Windowing applications display a dialog box when they need more information from you to carry out a task. Dialog boxes offer various ways to supply information. In some dialog boxes, you need to enter text. In others, you click MB1 on a button to change a setting. Some dialog boxes display settings you chose earlier.

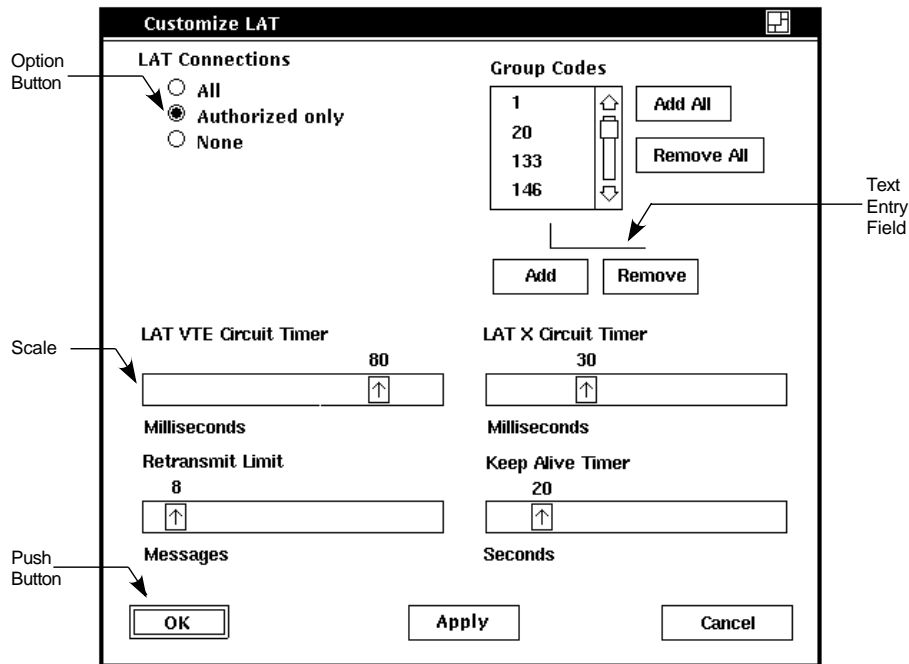

GSF_1035_89.RAGS

Text entry field

A vertical line text cursor shows you where the text you type will appear. What you type appears to the left of the text cursor. Use the **<X>** key to delete typing mistakes. Use the **<←>** and **<→>** keys to move within the text.

For dialog boxes with multiple text entry fields (such as Security), you can move between fields by:

- Clicking on each field with MB1.
- Pressing **Tab** to advance to the next field in the window.
- Pressing **Return** to advance to the next field in the set.

Option buttons

Clicking on an option button selects one option from a group.

Toggle buttons

Clicking on a square toggle button turns a setting on or off.

| | |
|-----------------------------------|--|
| Scale | Scales are often used to supply a numeric value. You drag a slider in the scale. The arrow in the slider points to the current value. |
| Push buttons | Clicking on a rectangular push button (such as OK, Apply, or Cancel) tells an application what to do with the information you supplied in the dialog box. |
| Push buttons with double outlines | The double outline indicates a <i>default option</i> . You can choose a default option by simply pressing <code>[Return]</code> or by clicking on the push button. Default options are those you will choose most frequently. The defaults can change, depending on the selections being made. Usually, the OK button is the default option in a dialog box. |
| OK push button | Records your choices and dismisses the dialog box. |
| Apply push button | Records your choices without dismissing the dialog box. |
| Cancel push button | Dismisses the dialog box without changing any settings. If you made any changes without applying them, clicking on the Cancel button prevents those changes from taking effect. |

Moving and Changing Settings in a Dialog Box

Here are the methods for moving in text entry fields and for changing text entries, button settings, and scales in a dialog box.

| To move ... | Press ... |
|-------------------------------|---|
| Forward between text fields. | <code>[Tab]</code> or <code>[Return]</code> |
| Backward between text fields. | <code>[Shift]</code> <code>[Tab]</code> |
| To the next word. | <code>[Shift]</code> <code>[→]</code> |
| To the previous word. | <code>[Shift]</code> <code>[←]</code> |
| To the beginning of the line. | <code>[F12]</code> or <code>[Ctrl]</code> <code>[H]</code> |
| To the end of the line. | <code>[Shift]</code> <code>[F12]</code> or <code>[Ctrl]</code> <code>[E]</code> |

| To delete . . . | Press . . . |
|---|---------------|
| The characters to the left of the cursor, up to and including the beginning of the word. | F13 or Ctrl J |
| The characters to the right of the cursor, up to and including the end of the word. | Shift F13 |
| The character to the left of the cursor and move all text to the right of the deleted character one space to the left. | <X |
| The character to the right of the cursor and move all text to the right of the deleted character one space to the left. | Shift <X |
| All characters to the start of the line. | Ctrl U |

| To . . . | Do this . . . |
|--|--|
| Refresh the window. | Press Ctrl R. |
| Change an option or toggle button setting. | Point to the option or toggle button and click MB1. |
| Change the numeric value on a scale. | Drag the slider left or right on the scale, or point to a location on the scale and click MB1. |

Using Scroll Bars

Some windows have *scroll bars* that let you view text or graphics that do not fit in the window. A scroll bar has *stepping arrows* at either end of the *scroll region*. The *slider* represents your relative position in the list or file. If the slider is at the top of the scroll region, the beginning of the list is visible. If the slider is at the bottom of the scroll region, the end of the list is visible.

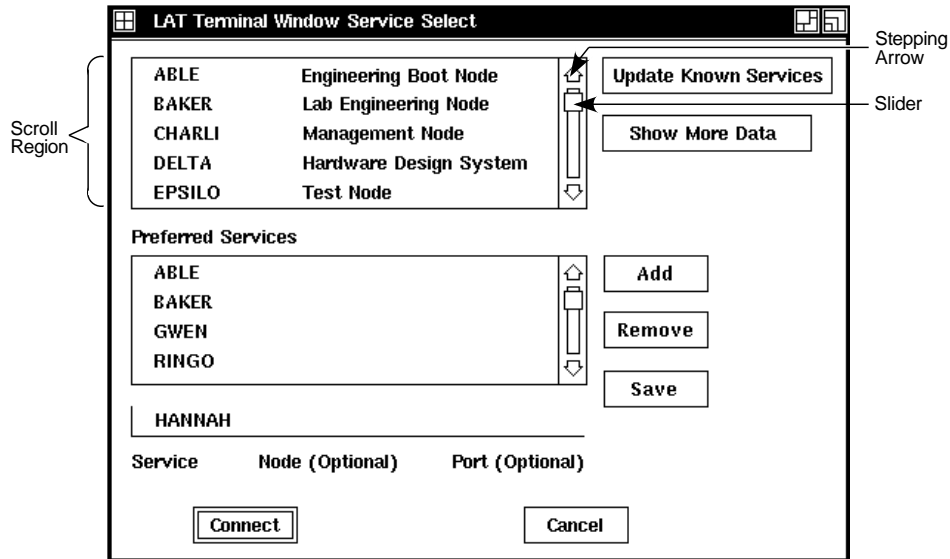

GSF_1037_89A.RAGS

The size of the slider tells you how much of the list the window is displaying. If the slider is as large as the scroll region, the complete list is displayed. If the slider is small, only part of the list is displayed. The smaller the slider, the larger the list. **Using scroll bars:** You can scroll a line at a time, a window at a time, or to a selected point.

To scroll . . .

Do this . . .

One line at a time.

Click MB1 on the stepping arrow at either end of the scroll bar.

Forward one window of text at a time.

Point to the scroll region below the slider and click MB1.

Backward one window of text at a time.

Point to the scroll region above the slider and click MB1.

| To scroll . . . | Do this . . . |
|---|---|
| Continuously, one line at a time. | Press and hold MB1 on the stepping arrow at either end of the scroll bar. |
| Continuously, one window of text at a time. | Press and hold MB1 in the scroll region. |
| To another location in the list or file. | Drag the slider to a point in the scroll region that you think corresponds to the location you want to see. For example, if the slider is at the top of the scroll region, you are viewing the beginning of the list or file. To cancel the drag, click another mouse button before releasing MB1. |

5

Using Video Terminal Windows

For some jobs, you may want to log in to a host system as you would on a conventional video terminal. The VT1000 terminal lets you open a video terminal (VTE) window. The VTE window offers the features of Digital's VT320 terminal with some enhancements. This chapter describes the video terminal (VTE) window and how to use it.

When you use a VTE window, you use the keyboard to interact with the host system. You can have several VTE windows on the screen at the same time, running different applications in each window. You can use your mouse to move between windows.

This chapter describes how to:

- Clear or reset the VTE window.
- Copy and paste information.
- Customize the VTE window settings

VTE Window Format

Chapters 3 and 6 describe how to start a video terminal session. The VTE window looks like this:

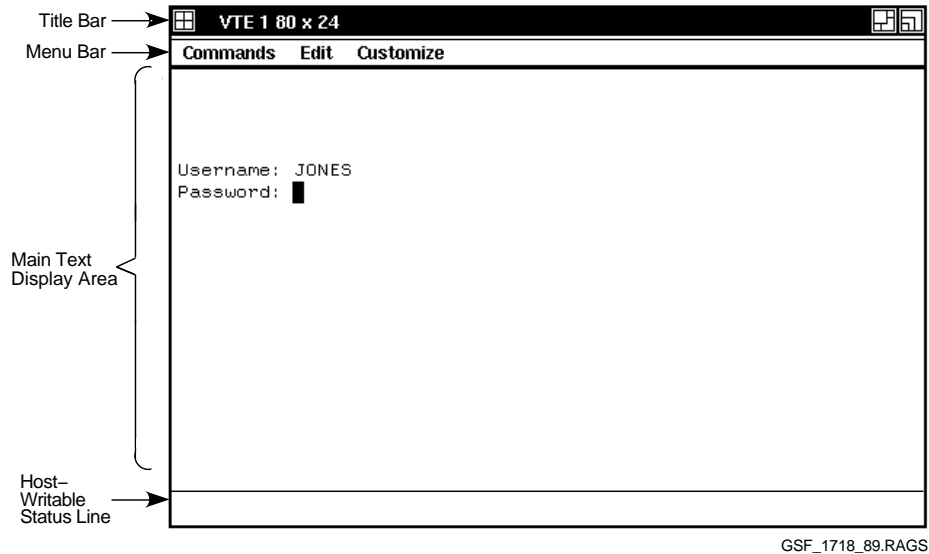

- The **title bar** identifies this window as a VTE window. VTE windows are numbered in the order that you open them. The title also includes the number of rows and columns available in the window. You can change this setting.
- The **menu bar** displays the names of the three pull-down menus available from the VTE window:

```
Commands      Edit      Customize
```
- The **main text display area** is your working area, similar to a video terminal screen. You interact with host applications in this area. By default, the size of this area is 24 lines by 80 columns. You can change the size by using the Customize menu in this window.
- If enabled, the **host-writable status line** lets host applications display messages to the user. A solid line separates the status line from the main text display area. By default, the status line is disabled.

Clearing, Resetting, or Leaving the Session

The Commands menu lets you clear, reset, or quit the VTE window. You pull down the Commands menu from the VTE window's menu bar. The Commands menu looks like this:

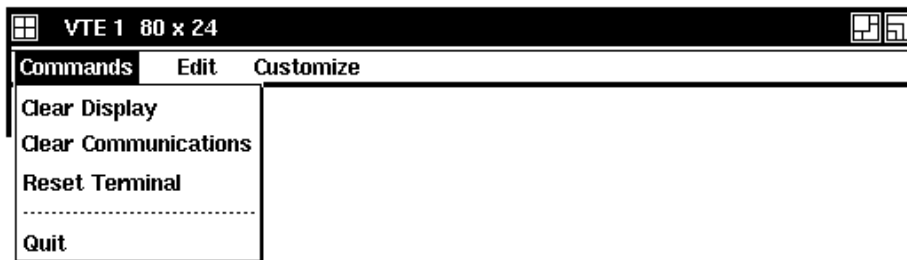

GSF_1313_89.RAGS

From the Commands menu, you can perform the following functions:

Clear Display

Choosing this item clears the contents of the current VTE window.

Clear Communications

Choosing this item performs the following actions:

- Cancels any print operation in progress.
- Cancels any escape sequence, control sequence, control string, or character string processing in progress.
- Clears the keyboard buffer.
- Clears the receive buffer.

Reset Terminal

Choosing this item sets several terminal operating features to their default settings.

| Resets . . . | To . . . |
|----------------------|---|
| Cursor mode | Visible. |
| Insert/replace mode | Replace. |
| Origin mode | Upper left of window, independent of margins. |
| Autowrap mode | Off. |
| Keyboard action mode | Unlocked. |
| Keypad mode | Numeric. |
| Cursor key mode | Normal. |
| Top margin | Line 1. |
| Bottom margin | The bottom line in the window. |

Quit

Choosing this item removes the VTE window, but does not end the process on the host. This action is similar to disconnecting a serial terminal session on a LAT DECserver. A VMS process will linger for 30 minutes by default. (Your system manager can change that time.) During that time, you can create another VTE window to the same host and reconnect to the same process.

The correct way to terminate a LAT or TELNET VTE window is to log out of the host system. When you log out, the window disappears.

On a serial line connection, you must both log out *and* then quit the VTE window. If you do not log out before quitting, an unauthorized user can create another window on your terminal and connect to your process without a password.

Copying and Pasting Text

You can copy and paste text in a window. You can also copy and paste text from one window to another.* To copy and paste text, you use the Edit menu. You pull down the Edit menu from the VTE window's menu bar. The Edit menu looks like this:

* You can copy and paste text between VTE windows and application windows that comply with the Interclient Communication Conventions Manual (ICCCM).

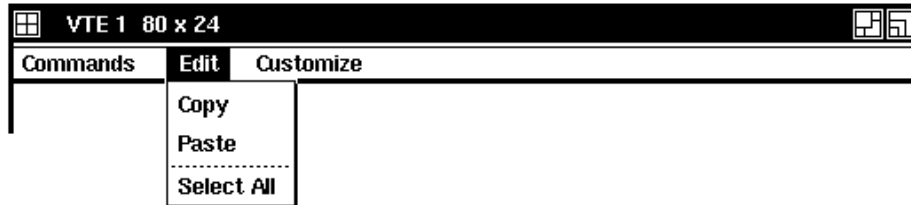

GSF_1311_89.RAGS

From the Edit menu, you can perform the following functions:

Copy

Choosing this item places the currently selected text into the terminal's copy buffer. You can also use the Select All menu item to select the complete window.

Paste

Choosing this item sends the contents of the terminal's copy buffer to the host application as if it were typed on the keyboard.

Select All

Choosing this item places all of the window's text into the terminal's copy buffer. You can also use the Copy menu item to place selected text into the copy buffer.

Host Synchronization Required

Copying and pasting large amounts of data requires that the host system be set to send XON/XOFF synchronization characters. This action prevents data overruns or overflows when the contents of the paste buffer is sent to the host.

Before you use the copy and paste features, enter one of the following commands:

On a VMS system

```
$ SET TERMINAL/HOSTSYNC
```

On an ULTRIX system

```
$ stty ixoff ixon
```

Selecting Text to Copy

You can select text a word, a line, or a block at a time. A block can be a single character or any number of contiguous characters, up to the complete window. You can also use the Select All menu item in the Edit menu to select the complete window.

To select a block of text:

1. Point to the start of the block.
2. Press and hold MB1, then drag the pointer to the end of the block.
3. Release MB1 to indicate the end of the block.
4. In the Edit menu, click on the Copy menu item.

To select a single word:

1. Point to the word.
2. Double click MB1 to select the word.
3. In the Edit menu, click on the Copy menu item.

To select a line of text:

1. Point to the line.
2. Triple click MB1 to select the line.
3. In the Edit menu, click on the Copy menu item.

To select a window:

1. Point to the window.
2. Quadruple click MB1 to select the window.
3. In the Edit menu, click on the Copy menu item.

Pasting Text

After you have selected text and stored it in the copy buffer, you can send the text to a host system. You can paste the text into the same VTE window, or into a different VTE window.

To paste text:

1. Place the cursor where you want to copy the text.
2. Choose the Paste menu item in the Edit menu. The terminal copies the text to the cursor position.

Using QuickCopy

QuickCopy lets you paste text without storing it in the copy buffer. There are two ways to use QuickCopy:

Method 1:

1. Select the text as described in “Selecting Text to Copy”.
2. Place the cursor where you want to paste the text.
3. Press and release MB3. If you accidentally move the mouse before releasing MB3, method 2 is activated.

Method 2

1. Place the cursor where you want to paste the text.
2. Point to the start of the text you want to copy.
3. Press and hold MB3. Drag the pointer to the end of the text to be copied. Release MB3 to copy the selected text to the cursor position.

You can use QuickCopy to copy text from one VTE window to another by moving the input focus to another window, then clicking MB3.

Copy and Paste Functions Disabled by Some Applications

If an application running in a VTE window supports positioning of its own pointer or cursor from the mouse, the copy and paste functions may not work. See your application’s documentation.

One example is the VMS text processing utility (TPU). To disable mouse input to TPU, use the following command:

```
TPU SET (MOUSE,OFF)
```

Customizing the VTE Window

You can set many features of the VTE window to your personal preference by using the Customize menu in the VTE window’s menu bar. This menu is similar to the Customize menu in the VT1000 Terminal Manager window (Chapter 7). The VTE window offers functions similar to Digital’s VT320 terminal, with some enhancements.

From the VTE’s Customize menu, you can change

- Window settings, such as the number of rows and columns displayed
- Display settings, such as the cursor style and background color

- General operating settings, such as the terminal's operating mode and character set selection
- Keyboard settings, such as the warning bell and the auto repeat function for keys
- National replacement character sets (NRCs), if you use 7-bit character sets

Applications May Customize Some Settings

Some applications that you use may also set certain window features. Programmers can use control sequences in their applications to customize most VTE features from the host system. The VT1000 supports most VT320 controls (Chapter 10). This type of customization provides more control to individual applications.

ReGIS and Sixel Graphics

VTE windows emulate the VT320 terminal, which is a text-only terminal. However, you can use ReGIS and sixel graphics on the VT1000, through the DECterm application under DECwindows. ReGIS is a graphics instruction set.

Note that there will be some limitations in the appearance of applications designed to use ReGIS, when displayed on the VT1000. The effect is similar to displaying the same graphics in DECterm on a one-plane workstation.

Feature Settings for New Windows

The VT1000 holds one complete set of feature settings in nonvolatile memory. When you open a new window, the terminal uses these settings to initialize the window.

Displaying the Customize Menu

Pull down the Customize menu from the VTE window's menu bar. The Customize menu looks like this:

Choosing any menu item displays a dialog box for that item. The following sections describe each dialog box.

Each dialog box has three push buttons for recording or dismissing new settings:

| Click on ... | To ... |
|---------------------|---|
| OK | Record new settings and dismiss the dialog box. |
| Apply | Record new settings without dismissing the dialog box. |
| Cancel | Dismiss the dialog box without changing any settings. If you made any changes without applying them, clicking on the Cancel button cancels those changes. |

Saving and Recalling Settings

If you make changes to settings, you can save them for use in all future VTE windows. If you do not save your new settings, they are lost when you end your current session.

If you make temporary changes to settings, you can recall the factory-default settings or the last settings you saved.

To save or recall settings, use the following menu items from the Customize menu:

| Choose . . . | To . . . |
|-------------------------|---|
| Use Last Saved Settings | Recall the last VTE settings you saved. Choose this menu item if you want to reset any features that you changed temporarily, but did not save. |
| Use System Defaults | Recall the VT1000 factory-default settings for VTE from read-only memory and from the host system defaults, if available. |
| Save Current Settings | Save the VTE settings you just changed, so you can use them in all future sessions. |

Some new settings do not take effect until you end your current session and begin another one.

Changing Your VTE Window Settings

To change your VTE window settings, select the Window.. menu item in the VTE Customize menu. The Customize VTE Window dialog box looks like this:

You can change the following features in the Customize VTE Window dialog box:

Auto Resize Terminal

If the size of a terminal window changes, the terminal normally adjusts the number of display rows and columns to match the window's size. You can turn this feature off or on by clicking on the Auto Resize Terminal button.

Default: off

Terminal Size

You can choose the number of rows and columns each VTE window uses. Normally, VTE windows use 24 rows by 80 columns to display data. There are two ways to change the number of rows and columns:

- Click on the Rows and Columns text entry fields under Terminal Size, then enter the desired settings. You can use from 1 to 99 rows and from 9 to 254 columns.
- Click on the desired number: 24 or 36 rows, 80 or 132 columns.

Default: 24 rows × 80 columns

Big Font, Little Font

Use the Big Font setting with monitors that have 100 dot/inch screens (such as the VR150, VR315, and VR319). Use the Little Font setting with monitors that have a 75 dot/inch screen (such as the VR262).

To choose the Big or Little Font, click on the appropriate button.

Default: Big Font

Normal Font, Condensed Font

Normally, the terminal displays characters in a font suitable for the display width—80 or 132 columns. You can also choose to use the normal font or condensed font at all times, by clicking on the Normal Font (80 Columns) button or Condensed Font (132 Characters) button. The condensed font lets you display more characters in a small window.

Default: Normal/80, Condensed/132

Window Title

You can choose a unique title for each VTE window you open. The default title is VTE *n*, where *n* is the number of the window. To enter a title, click on the Window Title text entry field. The title can have up to 30 characters. If you add the # symbol, the window size (rows and columns) also appears in the title.

Default: VTE *n* #

Icon Name

You can choose a unique icon name for each VTE window you use. To enter a name, click on the Icon Name text entry field. The name can have up to 30 characters.

If the icon name overlaps another icon, you can rearrange the icons by clicking on the Icon Box shrink-to icon button.

Default: VTE *n*

Changing Your VTE Display Settings

To change your VTE display settings, select the Display... menu item in the VTE Customize menu. The Customize VTE Display dialog box looks like this:

You can change the following settings in the Customize VTE Display dialog box:

Auto Wrap

Normally, text does not automatically wrap to the next line when the cursor reaches the right margin in the window. Click on the Auto Wrap toggle button to select whether or not text automatically wraps to the next line.

Default: off

Display Cursor

Normally, the text cursor appears in the VTE window as a block or underline character. Click on the Display Cursor toggle button to select whether or not to display a text cursor.

Default: on

Cursor Blink

Normally, the text cursor blinks. Click on the Cursor Blink toggle button to select whether the text cursor blinks or remains steady in the VTE window.

Default: Cursor Blink (on)

Text and Window Background

Normally, the VTE window displays dark text with a light background. You can change the window to display light text on a dark background by clicking on the Light Text, Dark Background button.

Default: Light Text, Dark Background

Status Display

Normally, the VTE window does not display a status line. You can choose to display a host status line by clicking on the Host Status Display button. The host status display is a line at the bottom of the window where the host application can display messages.

Default: No Status Display

Cursor style

Normally, the terminal uses a solid block cursor to indicate the active position. You can choose an underline character for the cursor by clicking on the Underline Cursor button.

Default: Block Cursor

Changing Your VTE General Operating Features

To change general operating settings, select the General . . . menu item from the VTE Customize menu. The Customize VTE General dialog box appears:

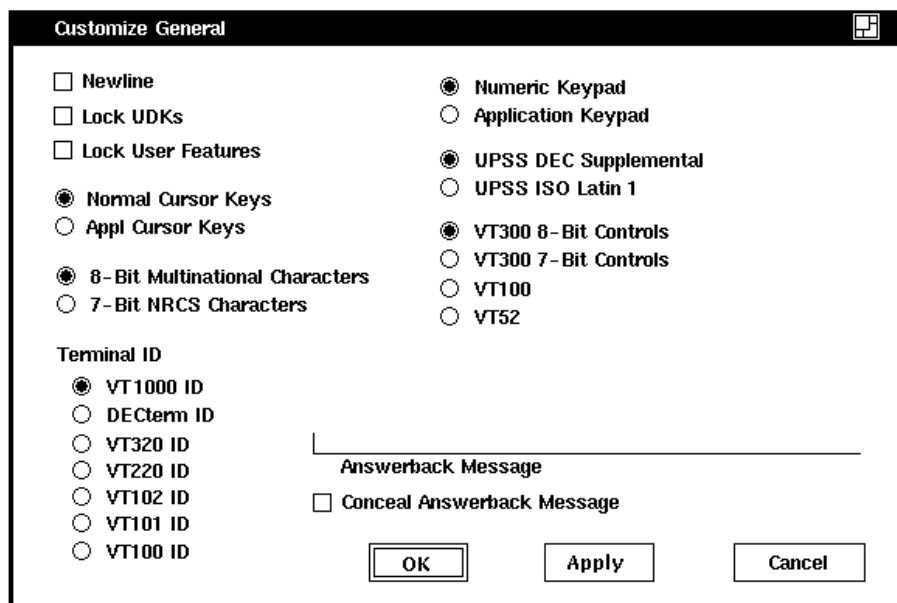

GSF_1372_89.RAGS

From the Customize VTE General dialog box, you can change any of the following settings:

Newline

This toggle button determines whether or not the key moves the cursor to a new line. Normally, pressing the key sends a carriage return character, but does not move the cursor to a new line. When you click on the Newline toggle button, pressing sends a carriage return and a line feed. Some non-Digital applications use the Newline feature.

Default: off

Lock UDKs

You can choose whether or not the host system can change user-defined key (UDK) definitions. Normally, the host can change UDK definitions. When you click on the Lock UDKs toggle button, the host cannot change UDK definitions.

Default: off

Lock User Features

You can choose whether or not the host system can change the settings of certain customized features that users often set to their own preference, including Column Mode, Display Background, and Auto Repeat. Normally, the host can change these user features. When you click on the Lock User Features toggle button, the host cannot change these features.

Default: off

Local Echo

You can choose whether or not to send the data typed at the keyboard to both the host system and the terminal. Normally, data is sent only to the host, which can then send the data back to the terminal.

Default: off

Cursor Keys

Normally, the arrow keys send standard ANSI cursor control sequences. Clicking on Appl Cursor Keys lets the arrow keys send application-specific control sequences.

Default: Normal Cursor Keys

8-Bit Multinational or 7-Bit NRCS Characters

You can select the type of characters the terminal uses, 8-bit multinational or 7-bit national replacement characters.

Normally, the terminal uses 8-bit multinational characters. This setting supports most of today's computing environments. There are two multinational character sets available—the DEC Multinational character set and the ISO Latin Alphabet No. 1 character set. Both sets consist of the ASCII character set and their own supplemental set. To choose one of the multinational character sets, you choose their supplemental set by using the UPSS buttons in this dialog box.

Clicking on the 7-Bit NRCS Characters button lets the terminal use one of several national replacement character sets. This setting is useful in computing environments that are restricted to 7 bits. NRC sets are 7-bit character sets for the major Western European languages. When you choose this setting, the terminal uses the NRC set that matches the current Keyboard Type chosen in the VT1000 Terminal Manager's Customize Keyboard dialog box (Chapter 7), by default. You can also choose the individual NRC set by using the 7-Bit NRCS Selection menu item from the VTE Customize menu.

Default: 8-bit Multinational Characters

Terminal ID

The VT1000 terminal sends the host system a terminal identification (ID) message to let the host know specific operating characteristics of the terminal. Normally, the terminal sends an ID of VT1000. You can choose which terminal ID the VT1000 sends to the host. The terminal ID is also called the device attributes response.

Default: VT1000 ID

Numeric Keypad

Normally, the keys on the numeric keypad send the number or punctuation mark shown on the keys (using ASCII codes). Clicking on the Application Keypad button lets the numeric keypad keys send control sequences used with some applications.

Default: Numeric Keypad

User-Preferred Supplemental Set (UPSS)

If you choose the 8-Bit Multinational Characters button in this dialog box, you can choose one of two supplemental character sets to use—DEC Supplemental or ISO Latin 1 Supplemental. Both character sets feature special characters used in the major European languages. The ISO Latin-1 set includes a few more characters that are not included in the DEC Supplemental set.

Normally, the terminal uses the UPSS ISO Latin 1 Supplemental set. Click on the UPSS DEC Supplemental button to use the DEC Supplemental set.

Default: UPSS ISO Latin 1

Terminal Mode

You can choose the terminal's operating mode. The VT1000 terminal can emulate the responses of VT52, VT100, VT200, or VT300 series text terminals to text and control functions sent from the host system. In either VT300 mode, the VT1000 accepts both 7 and 8-bit controls from the host.

Normally the terminal uses VT300 7-Bit Controls. In 7-bit controls mode, the VT1000 sends 7-bit controls and 8-bit graphic characters to the host. Use this mode with VT300 and VT200 applications that use 7-bit control characters.

In 8-bit controls mode, the VT1000 can send 8-bit controls and 8-bit text characters to the host. This mode supports VT300 and VT200 8-bit text applications.

VT100 mode lets the terminal run applications that require VT100 compatibility.

VT52 mode lets the terminal run VT52 applications.

Default: VT300 7-Bit Controls

Answerback Message

Normally, the terminal sends an answerback message to the host system after making a connection. To enter an answerback message, click on the Answerback Message text entry field. Your message can have up to 30 characters.)

The terminal sends this message to the host system when (1) you type **Ctrl** **Break**, or (2) the host requests the message by sending an ENQ character. Host requests do not affect screen data or require a user response.

Conceal Answerback Message

You can conceal your answerback message by clicking on the Conceal Answerback Message button. When you conceal the message, you cannot see the message in the Customize VTE General dialog box.

Default: off

Changing Your VTE Keyboard Features

To change keyboard settings used with VTE windows, choose the Keyboard . . . menu item from the VTE Customize menu. The Customize VTE Keyboard dialog box appears:

From the Customize VTE keyboard dialog box, you can change any of the following settings:

Warning Bell

Normally, a warning bell sounds whenever the terminal receives a bell (BEL) character from the host application. You can turn this feature off or on by clicking on the Warning Bell toggle button.

Default: on

Margin Bell

The terminal can sound a bell when the cursor approaches the right margin. Normally, the margin bell feature is turned off. You can turn this feature on or off by clicking on the Margin Bell toggle button.

Default: off

Auto Repeat

Normally, most keys on the keyboard automatically repeat when you hold them down. You can turn this feature off or on by clicking on the Auto Repeat toggle button. The **Help** and **Do** keys never autorepeat.

The VT1000 Terminal Manager's Customize Keyboard dialog box also has an auto repeat feature. If that feature is disabled, the auto repeat feature remains off regardless of the setting of the Auto Repeat button in the Customize VTE Keyboard dialog box, or host software customized settings (including remote session managers).

Default: on

Ctrl/Q, Ctrl/S = Hold

Normally, pressing **Ctrl S** prevents data from scrolling in a VTE window. Pressing **Ctrl Q** allows scrolling to resume in the window.

You can turn this feature off or on by clicking on the Ctrl/Q, Ctrl/S = Hold toggle button. If you turn the feature off, pressing **Ctrl S** or **Ctrl Q** have no effect on scrolling.

Default: on

<X> key

Normally, pressing the **<X>** key sends a delete (DEL) character to the host application.

When you click on the **<X>** Backspace button, the **<X>** key sends a backspace (BS) character.

Default: **<X>** Delete

,< and .> Keys Send ,, and ..

Normally, the **<** sends a < character when shifted, and the **>** key sends a > character. You can choose to have the **<** key always send a comma and the **>** key always send a period, whether the keys are shifted or unshifted. You can turn this feature on or off by clicking on the ,< and .> Keys Send ,, and .. toggle button. (Applies only to the North American, British, and Dutch keyboards.)

Default: off

Tilde Key

You can choose to send an escape (ESC) character when you press the tilde ``` or `[Shift] `` keys. Normally, pressing ``` key sends a `'` character to the host, and pressing `[Shift] `` sends a `~` character. You can turn the ESC feature on or off by clicking on the `'~ Key Sends ESC` toggle button. (Applies only to the North American, British, and Dutch keyboards.)

Default: off

Angle Bracket Key

You can choose to send a `'` character when you press the `[` key and a `~` character when you press the `(Shift) [` keys. Normally, pressing `[` sends a `<` character to the host. Pressing `[Shift] [` sends a `>` character. You can turn this feature on or off by clicking on the `<> Key Sends '~` toggle button. (Applies only to the North American, British, and Dutch keyboards.)

Default: off

Choosing National Replacement Character Sets

You can use 8-bit multinational character sets or 7-bit national replacement character (NRC) sets with VTE windows. You should use the type of character set that matches your computing environment. To choose the type of character set, use the `General...` menu item from the `VTE Customize` menu.

When you choose to use 7-bit character sets, the terminal uses the NRC set that matches the current `Keyboard Type` chosen in the `VT1000 Terminal Manager's Customize Keyboard` dialog box (Chapter 7), by default. You can also choose an NRC set from the `7-Bit NRCS Selection` menu item from the `VTE Customize` menu. The `Customize 7-Bit NRCS Selection` dialog box looks like this:

The scroll box lists all the NRC sets available. To choose an NRC set for the current VTE window, click on a set in the scroll box and then click on the OK button.

NOTE

The NRC set you select should match the Keyboard Type chosen in the Customize Keyboard dialog box.

Printing from a Video Terminal Window

To change print settings used with VTE windows, choose the Printer . . . menu item from the VTE Customize menu. The Customize VTE Printer dialog box appears:

From the Customize VTE Printer dialog box, you can change any of the following settings:

Printer Mode

You can select from three printing modes:

- Normal
- Auto Print
- Controller

Normal Mode: Printing Text on the Screen In normal mode, your VTE window displays text on the screen as on a typical text terminal. You can send all or part of the text in a VTE window to the printer. To print the screen press the **F2** (Print) key.

Auto Print: Printing from the Host System In this mode, the VT1000 sends the current display line to the printer when the cursor moves to the next line after a line feed, form feed, vertical tab, or autowrap. Auto print mode lets you print each line of text as it is received from the host.

To turn auto print mode on or off, press **Ctrl F2** (Print). You return to normal print mode when you leave auto print mode.

You can still perform printing functions with the **F2** (Print) key in auto print mode.

Controller Mode: Letting the Host Control the Printer In this mode, the host system can send text directly to the printer, without displaying the text on the terminal's screen. You cannot select this mode from the keyboard. Applications select this mode by using VT320 programming functions.

If you click on the 2-Way Printer Port button in the Customize Printer Port dialog box (Chapter 7), you can also display the text on the screen. The terminal sends characters received at the printer port back to the host.

The **F2** (Print) key does not work in printer controller mode.

Default: Normal

Print Extent Mode

Normally, the VT1000 sends only the text within the scrolling margins to the printer port. If you want to send the complete screen, click on the Entire Page button.

Default: Scroll Area

Print FF Mode

Normally, the VT1000 terminal does not send a form feed (FF) character to the printer port at the end of a print screen operation. If you want to send a form feed, click on the Form Feed button.

Default: No Form Feed

Printed Data Type

This feature lets you choose character sets to match the capabilities of your printer. The "National" settings refer to the 7-bit national replacement character (NRC) sets, including the default North American (ASCII) set. See "Choosing National Replacement Character Sets".

Default: National Only

| Click on this button . . . | For printers that support . . . |
|-----------------------------------|---|
| National Only | Only the national replacement character sets. Examples: LA34, LA36, and LA120 printers. |
| National + Line Drawing | The national replacement character sets and and the VT100 line drawing set. Example: LA100 printer. |
| All Characters | The multinational and line drawing sets. Examples: LA50 and LA75 Companion printers. |

6

Using the VT1000 Terminal Manager

The VT1000 Terminal Manager window appears on the screen at the start of every session. This window acts as a control panel for your current session. The VT1000 Terminal Manager window lets you:

- Create or end a session with a host.
- Print the contents of the screen.
- Customize the terminal's operating features (Chapter 7).

VT1000 Terminal Manager Window

When you turn on the terminal, the VT1000 Terminal Manager Window appears in the middle of the screen. An Icon Box appears at the top of the screen, and a diagnostic messages box appears at the bottom of the screen.

The VT1000 Terminal Manager window looks like this:

- The **title bar** at the top of the window displays:

| | |
|-------------------------------------|--|
| Shrink-to-icon button | To shrink a window to an icon. |
| VT1000 <i>Vn.n</i> Terminal Manager | Indicates firmware version. |
| Push-to-back button | To move a window to the bottom of a stack. |
| Resize button | To change the window size. |

- The **menu bar** displays the names of menus available:
 - Session To pause during or end a session.
 - Create To create a session.
 - Customize To customize terminal features.
 - Print Screen To print all or part of the screen.
- The **Messages** region displays VT1000 diagnostic or operating status messages.
- The **VT1000 Address** region shows the terminal's Ethernet, IP, and LAT addresses. These addresses define the terminal's location on a network, whether you are using TCP/IP or LAT.

- The **Memory Remaining, Kilobytes** region shows a scale indicating how many kilobytes of RAM memory remain available for use. The right end of the scale shows the total number of megabytes your system has: 1M, 2M, 3M, or 4M.

When you run applications or create windows that require large amounts of memory, you should monitor the memory remaining scale. The amount of memory being used changes all the time. If the terminal runs out of memory, it may stop functioning and you may lose work not yet saved. If the terminal runs out of memory, turn the system box off and on to recover. You can add up to 4 megabytes of optional memory to the VT1000, in 1-megabyte increments (Chapter 2).

- The **Secure Reset Count**: increases by 1 every time a secure reset occurs. A secure reset erases the terminal's nonvolatile memory (except the secure reset count) and resets the terminal's operating features to their factory-default settings. A secure reset also overrides saved passwords. To learn how to perform a secure reset, contact Digital Customer Services.

Creating Sessions on a Host System

The VT1000 terminal lets you create sessions on VMS, ULTRIX, or UNIX host systems. A *session* is an active connection between the terminal and the host system. You can open video terminal window (VTE) or X window sessions on any of these systems.

Video terminal (VTE) sessions let you log in to a host as you would with a conventional video terminal. The VTE window is compatible with many of Digital's video terminals.

X window sessions let you use X window or DECwindow applications running on your host system.

To create sessions to your host system, you use the Create menu in the VT1000 Terminal Manager window.

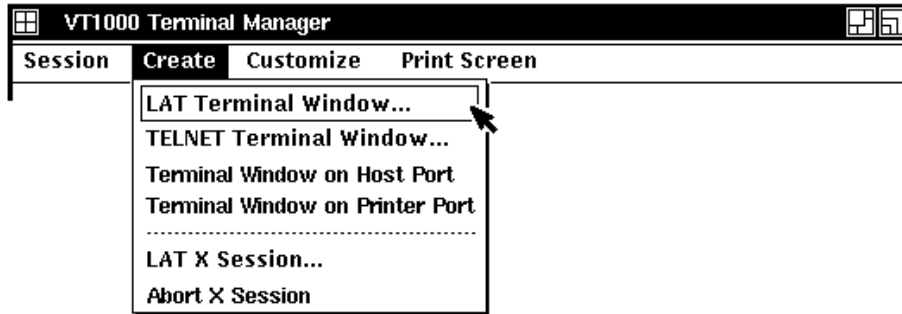

GSF_1018_89.RAGS

The following sections describe how to use the Create menu to create sessions on host systems.

| Choose this menu item . . . | To create . . . | On this system . . . |
|---------------------------------|--|----------------------|
| LAT Terminal Window . . . | Video terminal window | VMS or ULTRIX |
| TELNET Terminal Window . . . | Video terminal window | ULTRIX or UNIX |
| Terminal Window on Host Port | Video terminal window on the serial host port | VMS, ULTRIX, or UNIX |
| Terminal Window on Printer Port | Video terminal window on the serial printer port | VMS, ULTRIX, or UNIX |
| LAT X Session . . . | X window | VMS |

Notes on Creating Windows

- You can create multiple LAT and TELNET video terminal windows.
- On an ULTRIX system, you need UWS Version 2.2 or higher to use the LAT Terminal Window feature. The system manager must enable support. ULTRIX LAT supports video terminal (VTE) windows only (service class 1). X windows require service class 3.

- You can only open one terminal window for each serial port (host port or printer port). If the host port or printer port is in use, that menu item is dimmed and not selectable. You can select whether the printer port acts as a printer port or an alternate host port in the Customize Printer Port dialog box. The Customize Printer Port dialog box is described in Chapter 7.

Creating a Video Terminal Window on a VMS System

To create a video terminal window, you choose the LAT Terminal Window . . . menu item from the Create menu. The LAT Terminal Window Service Select dialog box appears. This dialog box provides access to hosts or services on a local area network that supports the local area transport (LAT) protocol. You use this dialog box mainly with the VMS operating system.

The dialog box lists all available hosts and services. You can assign preferred services that you use frequently. After you select a host, a new video terminal window appears. This window lets you access your host through the keyboard as on a conventional video terminal.

The LAT Terminal Window Service Select dialog box looks like this:

To use this dialog box, you must first enter one or more group codes into the Customize LAT dialog box. If you have not entered any group codes in the Customize LAT dialog box, click on the Cancel push button to dismiss the LAT Terminal Window Service Select dialog box. The Customize LAT dialog box is described in Chapter 7.

To start a session on a host:

There are three ways to start a session.

- **Method 1**

1. Use the keyboard to enter your service name into the Service Node Port text entry field.
2. Click on the Add button to add the service name to the Preferred Services scroll box.
3. Click on the Connect button.

- **Method 2**

Double click on your service name, either in the top scroll box (which lists known services) or the Preferred Services scroll box.

- **Method 3**

1. Click on a service name in the known services scroll box or the Preferred Services scroll box. The name appears in the Service Node Port text entry field under the Preferred Services scroll box.
2. Click on the Connect button or press the Return key.

Service, Node, and Port

The text entry field for Service, Node, and Port allows you to specify the connection you want in detail. Usually, you only need to enter the service name as listed in the known services scroll box.

Service Your terminal is connected to a local area network served by the Ethernet local area transport (LAT). Computing resources on the LAT use service names to announce themselves to the LAT. A computing resource can have any name, which the system manager assigns. Several resources can have the same name. Each resource can have many names.

When you request a connection to a service, the terminal checks the information sent by each resource with that name and connects to the least loaded resource. By convention, the service names include at least the DECnet node and cluster names.

The VT1000 can keep track of 64 known services at one time. The terminal displays them in the following places:

- **LAT Terminal Window Service Select dialog box**
 - 53 in the Service list
 - 4 in the Preferred Services list
 - 1 in the Service/Node/Port text entry field
- **LAT X Session Service Select dialog box**
 - 53 in the Service list (a subset of the Service list in the LAT Terminal Window Service Select dialog box)
 - 4 in the Preferred Services list
 - 1 in the Service/Node/Port text entry field
- **Customize Font Path dialog box**
 - 1 from either the LAT or TFTP Font Path text entry field

Node A *node* is an individual computer system on a local area network. A node may have various names, but generally the only names sepecific to that node are its DECnet node name and any other unique service name assigned by the LAT manager. You can request connection to a particular node if needed. For example, you may need to access a specific hardware resource like a communications port that is only accessible on that CPU.

Port A *port* is a communications connection on a CPU. An example is a serial line connected to a modem. You may need to get permission from the system manager to access a port from the network.

Update Known Services

When you click on the Update Known Services button, the scroll box to the left of the button updates the list of services available on the LAT.

If your service is not on the list, and you entered its group code in the Customize LAT dialog box, your service may have taken too long to broadcast its multicast message to the terminal. Other services with corresponding group codes may have filled the list first. If this occurs, remove unneeded group codes from the Customize LAT dialog box or add your service to the Preferred Services scroll box.

Your group code setting in the Customize LAT... dialog box must correspond to your node. See your system manager for group codes.

To view the list of nodes:

You can view a list of all nodes (as opposed to services) accessible on the LAT. Press **[Shift]** and click on the Update Known Services button.

Preferred Services

The Preferred Services scroll box lets you enter up to four frequently used host systems or services. Preferred services override other known services in the service list, and ensure that your regular services will remain known to the terminal. You can also enter an optional nodename and port number. This feature lets you specify a particular node within a service, and a particular port on a server device.

You can also use the other buttons in the dialog box to add or remove selections.

To add a new service from the known services scroll box to the Preferred Services scroll box:

1. Click on a service name from the known services scroll box.
2. Click on the Add button.

There must be an empty space in the Preferred Services scroll box before you can add a new host or service name to the box. Use the Remove button to delete an old host or service name from the box.

To remove a service from the Preferred Services scroll box:

1. Click on the service you want to remove.
2. Click on the Remove button.

To save the current entries in the Preferred Services scroll box:

Click on the Save button. This saves the list in the terminal's nonvolatile memory. You must perform this step to save any changes you make to the list.

To edit the Preferred Services scroll box:

You can edit entries in the box directly using the mouse and keyboard.

1. Click on the Service Node Port text entry field . A text cursor appears.
2. From the keyboard, type in a new service name. Use the `<X>` key if you make a mistake.

An entry can be a service name only, a service name and a nodename, or a service name, nodename, and port number. For example, any of the following entries are valid:

```
BETA
BETA_CLUSTER  BETA1
BETA_CLUSTER  BETA1  07
```

3. Click on the Add button. The new service entry appears in the Preferred Services scroll box.

To cancel a selection you have made:

Click on the Cancel button.

To view all accessible services in the known services scroll box:

Click on the Update Known Services button.

You may have to click on this button several times before the service you want appears. Sometimes it takes a few minutes for the terminal to establish communication with some services on the network.

To view all accessible nodes in the known services scroll box:

Press `Shift` and click on the Update Known Services button.

To display more technical data about a host or service:

1. Click on one of the services in the known services scroll box or in the Preferred Services scroll box.
2. Click on the Show More Data button. All the data known about the selected host or service appears in the known services scroll box.

Creating an X Window Session on a VMS System

To create an X window session, you choose the LAT X Session . . . menu item. The LAT X Session Service Select dialog box appears. The dialog box lets you start an X window or DECwindows session on a VMS host with X window software installed. After you select a host, the VT1000 begins a windowing session on that host.

This dialog box works the same as the LAT Terminal Window Service Select dialog box. For a description of how to use the LAT X Session Service Select dialog box, see “Creating a Video Terminal Window on a VMS System” in this chapter.

Known Services Scroll Box May Not List Some X Services

There are two things to remember when looking at the list of known services in the LAT X Session Service Select dialog box:

- The list may not include all the services listed in the LAT Terminal Window dialog box. Only those services that support the X protocol over the LAT (LAT class 3) are included.
- If your service is not on the list, and you entered its group code in the Customize LAT dialog box, your service may have taken too long to broadcast its multicast message to the VT1000. Other services with corresponding group codes may have filled the list first. If this occurs, remove unneeded group codes from the Customize LAT dialog box.

Working with Multiple Remote Session Managers

Each session manager you run on a remote host thinks it has complete control of your terminal. To maintain a consistent user interface when using multiple remote session managers, you must consider two issues—the terminal’s feature settings and the Quit feature.

Feature Settings When you start up session manager, it changes any settable characteristics of your terminal, such as screen background and keyboard selection. If you run multiple session managers, each one sets up the terminal according to the terminal's saved characteristics at the time the session manager starts up. To keep the characteristics from changing unexpectedly, be sure to change and save all your preferences in all of your session managers.

Quit Choosing the Quit option from any session manager will end all activity on the terminal. A Quit command is *not* a logout for that session only. Many session managers send an X protocol command to the terminal that stops everything and resets the terminal to its initial state. There is no way to log out from only one X session manager. Logging out of one session logs you out of all.

NOTE

VTE windows are disconnected, rather than logged out.

Multiple Connection Messages at Start of X Session

If connection request messages are enabled in the Customize Terminal Manager dialog box, you will see multiple connection and termination messages at the start of an X session. This is normal. See "Controlling the Display of Messages" in Chapter 7.

Monitoring Memory Usage

When you run applications or create windows that require large amounts of memory, you should monitor the Memory Remaining scale in the Terminal Manager window. If the terminal runs out of memory, the terminal may stop functioning. See "VT1000 Terminal Manager Window" in this chapter.

Canceling an Unwanted X Window Login Box

To cancel an X window login box, pull down the VT1000 Terminal Manager's Session menu and click on Quit. This action closes all connections and restarts the terminal.

Creating a Video Terminal Window or X Window Session on an ULTRIX or UNIX System

To create a video terminal window or X window session, you use the TELNET Terminal Window . . . menu item. When you select this item, the TELNET Terminal Window Host Select dialog box appears.

This dialog box provides access to hosts on a wide area network that supports the transmission control program/Internet protocol (TCP/IP). You use this dialog box mainly with the UNIX or ULTRIX operating system. The TELNET Terminal Window Host Select dialog box looks like this:

IP Address and optional host name

In the TCP/IP communication protocol, the terminal uses an IP address or host name to access a specific host computer on the network. You use the IP Address and optional host name list to enter IP addresses and optional host names. TCP/IP addresses and host names are limited to 30 characters. You can save up to four addresses in nonvolatile memory.

To enter a host:

1. Click on a button to activate the text entry field.

- Use your keyboard to enter an IP address and optional host name. Use the  key if you make a mistake.

There are three ways you can enter a host's IP address and host name. If you have Name Service available on your network, you can simply enter the host name in place of the host's IP address. See your system manager.

```
123.45.67.89
123.45.67.89 HOST_NAME
HOST_NAME (Requires Name Service.)
```

You can enter a host IP address in one of the following formats:

| Format | Example |
|--------------------------|-----------------|
| Decimal dot notation | 123.45.67.89 |
| Decimal whole number | 2066563929 |
| Hexadecimal | 0x762d4359 |
| Hexadecimal dot notation | 0x76.2d.43.59 |
| Octal dot notation | 0173.55.103.131 |
| Octal whole number | 017313241531 |

For TELNET communications, you can append a TELNET port number preceded by a comma. For example, if you appended port number 23 to the decimal dot address above, the address would be 123.45.67.89,23. You may only specify nonprivileged port numbers (with the exception of the TELNET port).

To connect to a host:

- Click on the button next to the IP address or host name you want to connect to.
- Click on the Connect button or press the  key.

To remove a host from the list:

- Click on the button next to the IP address/host name you want to remove.
- Click on the Remove button.

To save the current list of hosts:

Click on the Save button to save the list in nonvolatile memory. You must perform this step to save any changes you made to the list.

To cancel a selection you have made:

Click on the Cancel button.

TELNET ANSI Support

When you open a TELNET VTE window on a host system running ULTRIX Version 3.1 (UWS Version 2.1) or earlier (or an old version of TELNET), the host cannot determine the VT1000's terminal type. Early versions of TELNET do not support terminal type suboption negotiation. One symptom is that the vi screen editor enters open mode.

Define the TERM environmental variable to VT300, connecting to your host with one of the following commands:

C-shell

```
% setenv TERM vt300
```

Bourne shell

```
$ set TERM=vt300  
$ export TERM
```

Creating a Video Terminal Window on the Host or Printer Port (VMS, ULTRIX, or UNIX)

To create a video terminal window on the host port or video port, you choose one of the following menu items:

Terminal Window on Host Port

Lets you connect to a host through the host serial communication port. This port uses a 6-pin, DEC-423 connector on the rear of the system box.

Terminal Window on Printer Port

Lets you connect to a host through the printer port. This port uses the 6-pin, DEC-423 serial printer connector on the rear of the system box. Before you can open a terminal window on the printer port, you must set the printer port to work as a host port. See the Customize Printer Port dialog box section in Chapter 7. If you do not set the printer port to work as a host port, the Terminal Window on Printer Port menu item is dimmed and not selectable.

Creating a TCP/IP X Window Session

There is no menu selection to create a TCP/IP X window session, because there is no standard protocol for automatically starting an X window session manager from the terminal under TCP/IP.

To begin a TCP/IP X window session:

1. Log into the system by selecting the TELNET Terminal Window . . . menu item from the Create menu.
2. Start your applications with their output directed to your terminal.

C-shell

```
% setenv DISPLAY your_terminal's_IP_address:0
```

Bourne or Korn shell

```
$ DISPLAY=your_terminal's_IP_address:0
$ export DISPLAY
```

3. Start your client application.

C-shell

```
% dxterm
```

Bourne or Korn shell

```
$ dxterm
```

To work on a VT1000 as you would on a workstation:

1. Pull down the Customize menu from the VT1000 Terminal Manager menu bar.
2. Choose the Customize Window . . . dialog box.
3. Click on the Allow Remote Window Manager button.
4. For UWS Version 2.1, you must specify the display address in the command to start the X window session application:

Bourne or Korn shell

```
% dxsession -d your_terminal's_IP_address:0
```

C-shell

```
$ dxsession -d your_terminal's_IP_address:0
```

For UWS Version 2.2, the X window session application gets its address from the DISPLAY definition:

C-shell

```
% dxsession
```

Bourne or Korn shell

```
$ dxsession
```

Pausing or Ending Sessions

The terminal manager's Session menu lets you pause during a session or quit a session.

Pausing a Session

You can pause a session at any time. When you pause a session, the terminal covers the entire screen with the `Enter password to resume` prompt.

Restrictions

- For ULTRIX systems, UWS Version 2.1 does not support the pause function for remote sessions.
- Due to the system disconnect behavior on serial lines, do not use Pause with sessions connected through the serial host port or printer port.

To pause your session:

1. Pull down the Session menu from the VT1000 Terminal Manager's menu bar.
2. Click on the Pause menu item. The Pause Password dialog box appears.

3. You can either enter a new password or use the previous password.

To enter a new password:

- Enter the new password (up to 127 characters) into the Enter Password text field.
- Click on the Verify Password text field and enter the same password into the Verify Password text field. If you make a mistake, click on the Clear button to start over.

Click on the Save pushbutton if you wish to save the password for future sessions.

- Click on the OK button to save the password and exit the dialog box.

If you have already entered a password:

You can pause the session by clicking on the Use Previous Password button.

When you click on the OK or Use Previous Password pushbuttons, the terminal enters the pause state and the `Enter Password to resume` prompt appears.

To exit the pause state and resume session activity:

Enter your password and click on the OK button.

If you forget the password, you can click on the Quit button to end all sessions.

| If you select . . . | The terminal . . . |
|----------------------------|---|
| OK | Verifies that your password is correct. |
| Clear | Clears the password field. |
| Quit | Ends all sessions on the terminal (like Quit in the Session menu). |

Ending a Session

When you use the Quit menu item in the Session menu to end a session, the terminal manager disconnects all sessions (local and remote) and restarts the terminal, including setting the font path again. The Quit function in the remote session manager of any VMS X window session performs the same action. You should plan to end the session as the last activity of that work period.

When you end a session, the VT1000:

- Ends all sessions.
- Clears the screen of all windows.
- Performs a complete software reset.
- Recovers all memory.

- Displays the VT1000 Terminal Manager.
- Attempts to set a font path.

To end your session:

1. Pull down the Session menu from the VT1000 Terminal Manager's menu bar.
2. Click on the Quit menu item. A prompt box appears that asks you if you really want to end the session.
 - To end the session, click on Yes.
 - To remain in the session, click on No.

If you made changes in the Customize menu and have not saved the changes, another prompt box appears, asking if you would like to save them.

| If you select . . . | The terminal . . . |
|----------------------------|--|
| Yes | Saves the current settings before performing a restart operation. |
| No | Immediately quits the session without saving your changes. |
| Cancel | Does not quit the session. You can resume working in that session. |

Quitting From a Remote Session Manager

When quitting from a remote session manager, a prompt box may appear asking if you want to save customization changes before quitting. This question refers to customization changes made to the remote session manager settings only.

Quitting from a remote session manager does not save VT1000 Terminal Manager settings. To save customization changes made to the VT1000 Terminal Manager during the session, select Save Current Settings in the Terminal Manager Customize menu.

Quitting from the remote session manager (dxsession) on an ULTRIX system over TCP/IP:

- Terminates dxsession and dxwm.
- Does not terminate all applications (clients) started under that manager.

- Does not reset the terminal.

Customizing Your VT1000 Environment

The Customize menu in the VT1000 Terminal Manager window lets you check and control the settings for many features—from the keyboard to host communications. Chapter 7 describes the VT1000 Customize menu.

Printing the Screen

The Print Screen menu in the VT1000 Terminal Manager window lets you print all or part of the screen display, using a local printer connected to the rear of the terminal.

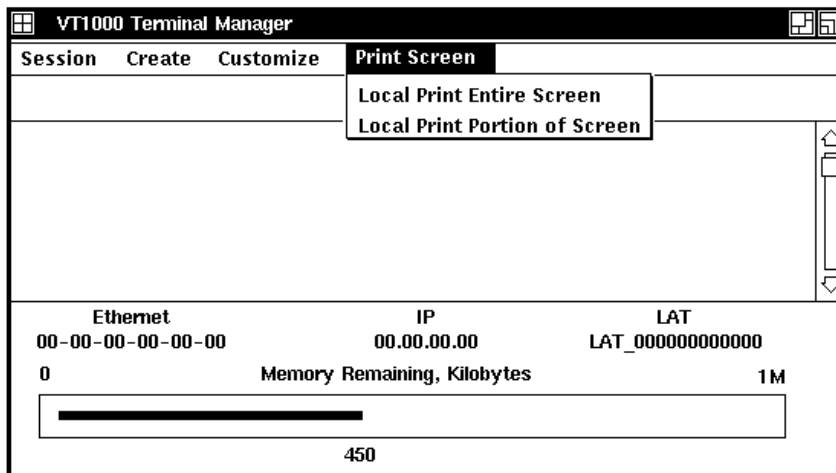

GSF_1044_89.RAGS

If you are currently using the printer port as a second host port, the print screen selections in the menu are dimmed and not available.

The VT1000 terminal encodes the screen image into units called sixels, then sends the encoded image to the local printer. A *sixel* is a vertical column of six pixels. *Pixels*, or picture elements, are the smallest displayable unit on a video screen.

The VT1000 supports level 1 and level 2 Digital printers. Level 1 printers include the LA50 dot matrix printer. Level 2 printers include the LA75 dot matrix printer and the LN03 laser printer.

To print the complete screen image:

Choose the Local Print Entire Screen menu item.

To print a portion of the screen image:

1. Choose the Local Print Portion of Screen menu item. The pointer turns into a cross.
2. Hold down MB1, then drag the pointer across the portion of the screen you want to print. As you drag the pointer, a rectangle forms around the portion of the screen.
3. Release MB1 to send the image to the printer.

Printer Status

Printer status messages appear in the Messages region of the VT1000 Terminal Manager window.

- A `Printer Offline` message appears if a print request is made but the DTR signal from the printer is not asserted within 2 seconds. This message occurs if the printer is turned off or not connected.
- A `Printer Busy` message appears if a print request comes in while the printer is printing another job.

In both cases, the print request is canceled.

Canceling a Print Screen Operation

During large printing jobs, a Print Cancel dialog box appears on the screen to let you cancel the print operation. Click on the Okay button to cancel the print operation. Printing stops when the printer empties its input buffer. The Print Cancel dialog box is not printed.

7

Customizing the VT1000 Terminal Manager

The Customize menu in the VT1000 Terminal Manager window lets you check and control the settings for many features—from the keyboard to host communications. Initially, the features use factory-default settings that work with many host systems. You can make temporary changes for the current session, or you can save the settings for all future sessions.

To access the terminal's operating features, you use the Customize menu in the VT1000 Terminal Manager window. You can look at the current settings of features, change them, and save the new settings. The following sections describe the Customize menu items.

There are three other ways to customize certain features of your terminal:

- **VTE Customize menu**
When you open a video terminal window, you can choose another Customize menu. This menu lets you change certain video terminal window features while an application is running. Most of the time, the application handles customization of the video terminal window. Chapter 5 describes how to use the video terminal (VTE) window.
- **Host-based control functions**
Applications can control many terminal features from the host by using control functions. Chapter 10 is a summary of VT1000 specific control functions that control the video terminal window.
- **Client Customize**
The X window or DECwindows software package includes its own Customize utility, not described here. For more information on the DECwindows Customize utility, see the *VMS DECwindows User's Guide*.

Displaying the Customize Menu

You pull down the Customize menu from the VT1000 Terminal Manager's menu bar. The Customize menu looks like this:

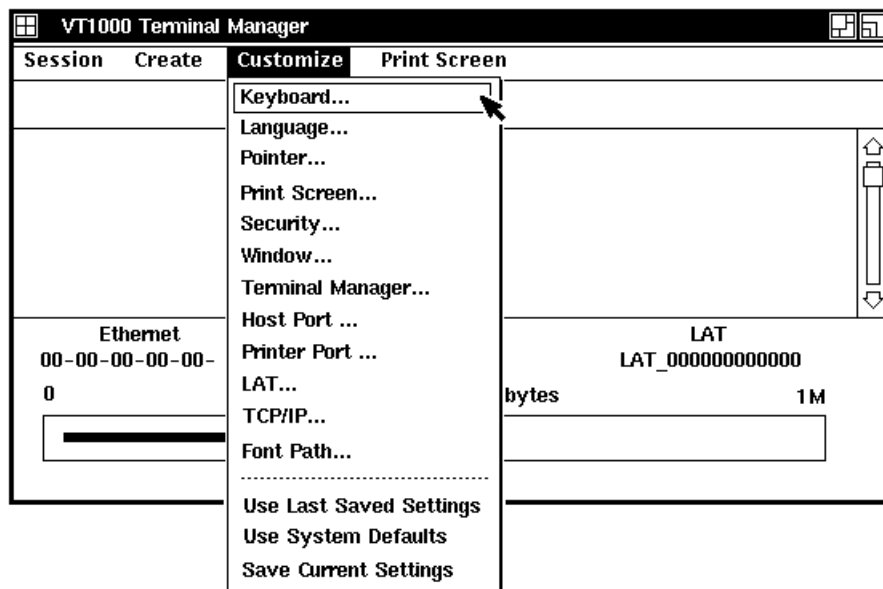

GSF_1708_89.RAGS

When you choose a menu item from the menu, the dialog box for that item appears. Shaded buttons indicate the current settings. You can examine the settings and change them if necessary. After you make changes in a dialog box, you can record your settings or dismiss the dialog box.

When you record your settings, the new settings take effect for that session only. To use the new settings for all future sessions, you must save the settings in nonvolatile memory. See "Saving and Recalling Settings" in this chapter.

Each dialog box has three push buttons for recording or dismissing new settings:

| Click on ... | To ... |
|---------------------|---|
| OK | Record new settings and dismiss the dialog box. |
| Apply | Record new settings without dismissing the dialog box. |
| Cancel | Dismiss the dialog box without changing any settings. If you made any changes without applying them, clicking on the Cancel button cancels those changes. |

Saving and Recalling Settings

If you make changes to settings, you can save them for use in all future sessions. If you do not save your new settings, they are lost when you end your current session.

If you make temporary changes to settings, you can recall the factory-default settings or the last settings you saved.

To save or recall settings, use the following menu items from the Customize menu:

| Choose ... | To ... |
|-------------------------|---|
| Use Last Saved Settings | Recall the last settings you saved. Choose this menu item if you want to reset any features that you changed temporarily, but did not save. |
| Use System Defaults | Recall the VT1000 factory-default settings for the VT1000 Terminal Manager from read-only memory. |
| Save Current Settings | Save the VT1000 Terminal Manager settings you just changed, so you can use them in all future sessions. |

Some new settings do not take effect until you end your current session and begin another one.

Changing Your Keyboard Settings

To change your keyboard settings, choose the Keyboard . . . menu item from the Customize menu. The Customize Keyboard dialog box appears:

NOTE

You can also customize some keyboard settings for individual VTE windows. See Chapter 5.

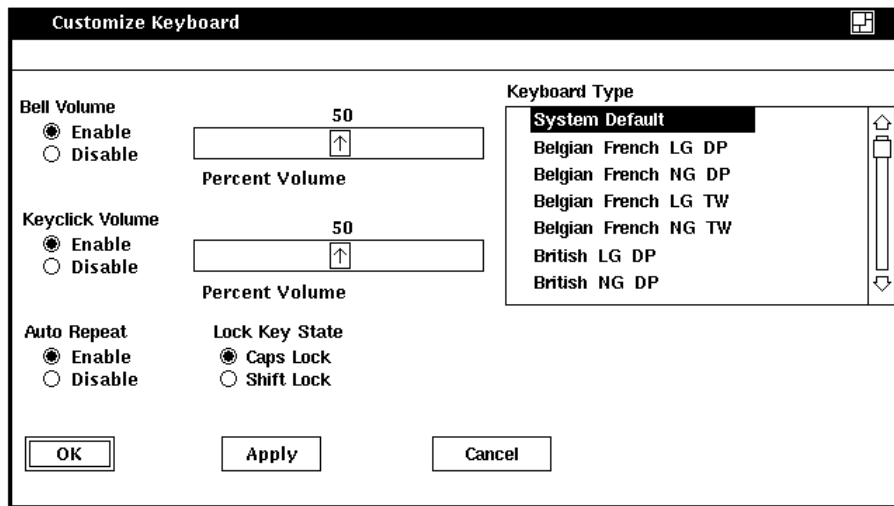

GSF_1046_89.RAGS

From the Customize Keyboard dialog box, you can change any of the following settings:

Bell Volume

A warning bell sounds to alert you to system messages. You can adjust the bell volume by dragging the arrow in the Percent Volume slider to the right or left. You can also adjust the bell volume by moving the pointer to a location on the slider and clicking MB1. To disable the bell, click on the Disable button.

Default: Enable

Keyclick Volume

Each time you press a keyboard key, the keyboard makes a clicking sound. You can adjust the keyclick volume by dragging the arrow in the Percent Volume slider right or left. You can also adjust the keyclick volume by moving the pointer to a location on the slider and clicking MB1. To disable keyclicks, click on the Disable button.

When you use VTE windows, some keys click or autorepeat differently than they would when using a DECterm window under DECwindows or when using a VT320 video terminal.

Default: Enable

Auto Repeat

When you press a key longer than normal, it repeats until you release it. To disable the auto repeat feature, click on the Disable button. The `[Help]` and `[Do]` keys never autorepeat.

When disabled in this dialog box, the auto repeat feature remains off regardless of the setting of the Auto Repeat button in the Customize VTE Keyboard dialog box, or host software customized settings (including remote session managers).

When enabled in this dialog box, the auto repeat feature can be turned on or off in the Customize VTE Keyboard dialog box, or by host software.

Default: Enable

Lock Key State

Normally when you press the lock key on the keyboard, the alphabetic keys send uppercase letters but the number keys do not send their shifted character.

When you click on the Shift Lock button, all keys send their shifted character.

Default: Caps Lock

Keyboard Type

The VT1000 keyboard comes in different models for different languages and dialects. The location of some characters varies depending on the keyboard model. Make sure the keyboard type matches your keyboard model, so the system sends the correct character when you press the corresponding key.

The default keyboard type is North American. If you have any other keyboard model, you must select the correct keyboard type when the terminal is installed.

To find your keyboard model number: Turn the keyboard upside down and look for a label that specifies the model number. The model number should be in a format similar to LK401-*xx* or *nn-nnnnnn-xx*. Use the *xx* value to choose your keyboard type from the Keyboard Type scroll box.

For example, if you have a British keyboard and the model number is LK401-AA, you choose LK401-AA British.

To use this new keyboard type for all future sessions, save the new setting before you end the current session. See “Saving and Recalling Settings” in this chapter.

When using DECwindows: The DECwindows host session manager has a similar customize option. Digital recommends that you leave the host setting at System Default to avoid having the host session manager and local terminal manager compete to set the keyboard. There are subtle differences between the LK401 keyboard layouts supported by the VT1000 and the LK201 keyboard layouts supported by DECwindows.

Default: North American

Keyboard Mode

You can specify whether you want your keyboard to act as a typewriter (TW) or data processing (DP) keyboard. This setting affects keys with three or more characters. If you choose a data processing keyboard, these keys send the characters on the right half of their keycaps. If you choose a typewriter keyboard, these keys send the characters on the left half of their keycaps.

For the following keyboard types, the typewriter and data processing settings are identical:

- North American and Dutch
- When using 8-bit multinational characters: British, German, and Portuguese

Default: Typewriter

Choosing the Display Language

Customize Language

The VT1000 Terminal Manager supports three languages: English, French, and German. After you apply your selection, the terminal displays text in the language you selected. To change your display language setting, choose the Language . . . menu item from the Customize menu. The Customize Language dialog box appears:

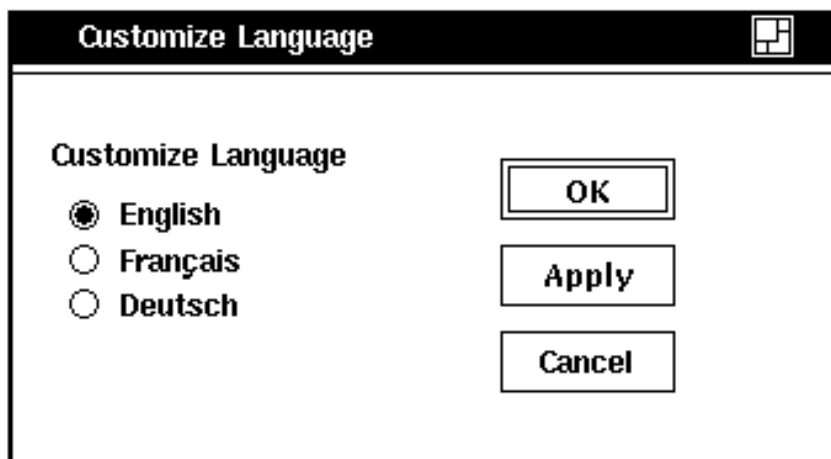

GSF_1047_89.RAGS

To select a language, click on the appropriate button.

The selected language only applies to the VT1000 terminal locally. There may be times when your host application has a different setting than your terminal.

Default: English

Changing Your Pointer and Mouse Settings

You can change the shape and color of the pointer, as well as certain mouse features. To change your mouse and pointer settings, choose the Pointer . . . menu item from the VT1000 Terminal Manager's Customize menu. The Customize Pointer dialog box on your monochrome VT1000 terminal looks like this:

From the Customize Pointer dialog box, you can change any of the following settings:

Button Arrangement

The default mouse button arrangement is natural for a right-handed user—MB1 on the left of the mouse and MB3 on the right. If you are left-handed, you can click on the Left Handed button. This makes MB1 the right mouse button and MB3 the left mouse button. MB2 is always the middle button.

Default: Right Handed

Pointer Color

The pointer consists of an outline and filled center. On your monochrome VT1000 terminal, the pointer's filled area is normally white with a black outline. To reverse the fill and outline colors, click on the Black button. To see your changes, click on the Apply button or OK button in the dialog box.

Default: White

Pointer Shape

To change the pointer shape, scroll through the list of shapes and select the one you want.

Default: Upper Left Arrow

Mouse Double Click Timeout

Video terminal (VTE) windows can tell two single clicks from a double click, based on the speed at which buttons are clicked. To change the time allowed for making the second click in a double-click sequence, drag the arrow in the slider to the right or left, or move the pointer to a location on the slider and click MB1.

Changing Your Print Screen Settings

The terminal's Customize Print Screen dialog box lets you control certain printing features. To view the print screen settings, choose the Print Screen . . . menu item from the VT1000 Terminal Manager's Customize menu. The Customize Print Screen dialog box appears:

From the Customize Print Screen dialog box, you can change the following settings:

Pixel Aspect Ratio

You can select the pixel aspect ratio to match the dot density of the printer you are using. A pixel aspect ratio of 1 to 1 is appropriate for most printers.

- For level 2 printers such as the LA75 or LN03, use a pixel aspect ratio of 1 to 1.
- For level 1 printers such as the LA50, use a pixel aspect ratio of 2 to 1.

Default: 1 to 1

Rotate/Scale Picture

For wide screen images, you can have the terminal rotate and scale the image so it fits on the printed page. Click on the Rotate/Scale Picture button to automatically rotate and scale an image sent to the printer.

Default: off

Ribbon or Toner Saver

Normally, screen snapshots are printed as you would expect—the image is dark, and the background is light. If you have an image that fills most of the screen, this may consume a great deal of printer ribbon or toner. To reverse the dark and light portions of the printed output and save ribbon or toner, click on the Negative Image button.

Default: Positive Image

Print FF Mode

The VT1000 terminal can send a form feed (FF) character to the printer port at the end of a print screen operation. If you want to send a form feed, click on the Form Feed button.

Default: No Form Feed

Changing Your Security Settings

To prevent unauthorized connections to your terminal, you can enter a list of authorized users that can connect to your terminal. You can also lock your customize dialog boxes to prevent accidental and unauthorized changes to your customized settings.

Choose the Security . . . menu item from the VT1000 Terminal Manager's Customize menu to display the Customize Security dialog box:

From the Customize Security dialog box, you can change any of the following settings:

LAT Connections and TCP/IP Connections

You can choose which hosts can connect to your VT1000 terminal. Only authorized hosts can make connections to the terminal. To allow all hosts, no hosts, or only those authorized to connect to the terminal, click on the appropriate button.

All This is the default setting. Any system on the Ethernet can establish an X connection with your terminal. Use this setting if you are part of a small group running interactive applications that require sharing of information in realtime.

Authorized Only When you choose this setting, only the systems and users entered in the Authorized Users scroll box can establish X connections with your terminal. This setting requires that you authorize your own account in addition to any others that need access to your display.

None This setting prevents any X connection to your terminal, regardless of source. This is useful if you use the VT1000 as multiple VT320 terminals in a confidential environment, and do not want any other user's applications to display on your screen or to request data from your screen.

If you choose the None setting, any connection request from the LAT X Session menu item in the Create menu will fail.

Default: All

Add an Authorized User

You can maintain a list of four authorized users. These users have immediate access to your VT1000 terminal. The VT1000 stores the node names, usernames, and transports (LAT or TCP/IP) of these users, in nonvolatile memory.

To add an authorized user to the Authorized Users box:

1. Enter a node name or IP address into the Node text entry field, then press the **Return** key.

Examples: DELTA or 123.45.67.89

2. Enter a username into the Username text entry field, then press **Return**. You can use the asterisk (*) wildcard character to specify all users.

Examples: Smith or *

For TCP/IP: Use the asterisk (*) wildcard character, to specify all users. The TCP/IP protocol does not track usernames, so you cannot authorize individual users when accepting TCP/IP connections. If the node is an approved IP address, the VT1000 accepts any connections from that node.

3. Enter a transport (communication protocol) into the Transport text entry field, then press **Return**.

Examples: LAT or TCP.

The newly authorized user appears in the Authorized Users box.

Remove an Authorized User

To remove an authorized user from the Authorized Users box:

1. In the Authorized Users box, click on the username of the user you want to remove.
2. Click on the Remove button.

Accept Connections When Idle

Your VT1000 terminal has the ability to accept connections from authorized host systems when idle. The terminal is idle from the time it is turned on and completes its power-up tests until a menu item is chosen in the VT1000 Terminal Manager.

This feature lets your terminal act as a slave display device requiring no active intervention. To enable this feature, click on the Accept Connections When Idle button. This allows the terminal to accept X window and DECwindows connections when idle.

NOTE

For desktop units where people frequently log in, accepting connections when idle may be a security risk. Digital recommends that you leave this feature off for desktop units.

Default: off—reject connections when idle

Locking Your Customize Dialog Boxes

You can lock your VTE or VT1000 Terminal Manager customize dialog boxes to prevent accidental and unauthorized changes to your customized settings. You can also choose whether or not to make a locked customize dialog box visible. By default, all customized dialog boxes are unlocked.

When you lock dialog boxes, the Customize Security Password dialog box appears. See “Activating Customize Password Security ” in this chapter.

Lock Customize Security

You can lock the Terminal Manager's Customize Security dialog box to prevent unauthorized users from adding more users to the Authorized Users list. Click on the Lock Customize Security toggle button, then click on the OK button or Apply button. The Customize Security Password dialog box appears.

Default: Unlocked

Lock Terminal Manager Customize

You can lock all customize dialog boxes in the VT1000 Terminal Manager Customize menu, to prevent unauthorized users from changing customized settings. Click on the Lock Terminal Manager Customize toggle button, then click on the OK button or Apply button. The Customize Security Password dialog box appears.

Default: Unlocked

Lock VTE Customize

You can lock all customize dialog boxes in the VTE Customize menu, to prevent unauthorized users from changing customized settings. Click on the Lock VTE Customize toggle button, then click on the OK button or Apply button. The Customize Security Password dialog box appears.

Default: Unlocked

Locked Screens Visible

You can choose whether or not to make locked customize dialog boxes visible. To change the current setting, click on the Locked Screen Visible toggle button, then click on the OK or Apply button.

Default: off—locked screens not visible

If a customize dialog box is locked and visible: When you choose the customize dialog box from the Customize menu, the dialog box appears but you cannot change any settings. The one exception is the Customize Security dialog box. It always requires a password if it is locked.

If a customize dialog box is locked and not visible: When you choose that customize dialog box from the Customize menu, a Password prompt appears. You must enter the correct security password before you can display the dialog box.

To display a locked customize dialog box that is not visible: Enter your security password and click on the OK button. If you enter the correct password, the selected customize dialog box is displayed and you can make changes to the settings. If you enter an incorrect password, the terminal displays a `User authorization failure` box.

| If you select . . . | The terminal . . . |
|----------------------------|---|
| OK | Verifies that your password is correct. |
| Clear | Clears the password field. |
| Cancel | Dismisses the password prompt. |

If you forget the password, contact Digital Customer Services to perform a secure reset. A secure reset erases all of the terminal's nonvolatile memory (except the secure reset count) and resets the terminal's operating features to their factory-default settings.

Activating Customize Password Security

To prevent accidental or unauthorized changes to your VTE or VT1000 Terminal Manager customize dialog boxes, use the `Lock . . .` toggle buttons in the Customize Security dialog box. When you turn on one of these toggle buttons and click on the Apply or OK button, the Customize Security Password dialog box appears. From the Customize Security Password dialog box, you can enter a new customize security password or use the current password.

From the Customize Security Password dialog box, you can choose the following items:

Enter Password

To enter or change the security password, type a new password (up to 127 characters) into the Enter Password text entry field. The terminal does not display the characters you enter, and the cursor does not move. Then click on the Verify Password text entry field.

Verify Password

To make sure the password you entered is correct, reenter the password into the Verify Password text entry field. The terminal does not display the characters you enter, and the cursor does not move. After you enter the password, click on the OK button to activate the password and dismiss the dialog box.

If you enter the incorrect password, the terminal displays a `Password Verification Error` box.

To save the password for future sessions, use the Save Current Settings menu item in the VT1000 Terminal Manager's Customize menu.

Use Previous Password

If you already entered a password in this session (or saved a password in a previous session), you can click on the Use Previous Password button to quickly dismiss this dialog box and activate your customize password.

OK, Clear, and Cancel

| If you select . . . | The terminal . . . |
|---------------------|--------------------|
|---------------------|--------------------|

| | |
|----|-------------------------|
| OK | Activates the password. |
|----|-------------------------|

| | |
|-------|---|
| Clear | Clears both password text entry fields and moves the cursor to the Enter Password text field. |
|-------|---|

| | |
|--------|---|
| Cancel | Dismisses the Customize Security Password dialog box and returns to the Customize Security dialog box without activating password security. |
|--------|---|

Changing Your Window Settings

You can change the look of your terminal's window display. For example, you can change the background pattern, window color, and screen color. To change your window settings, choose the Window . . . menu item from the VT1000 Terminal Manager's Customize menu. The Customize Window dialog box looks like this:

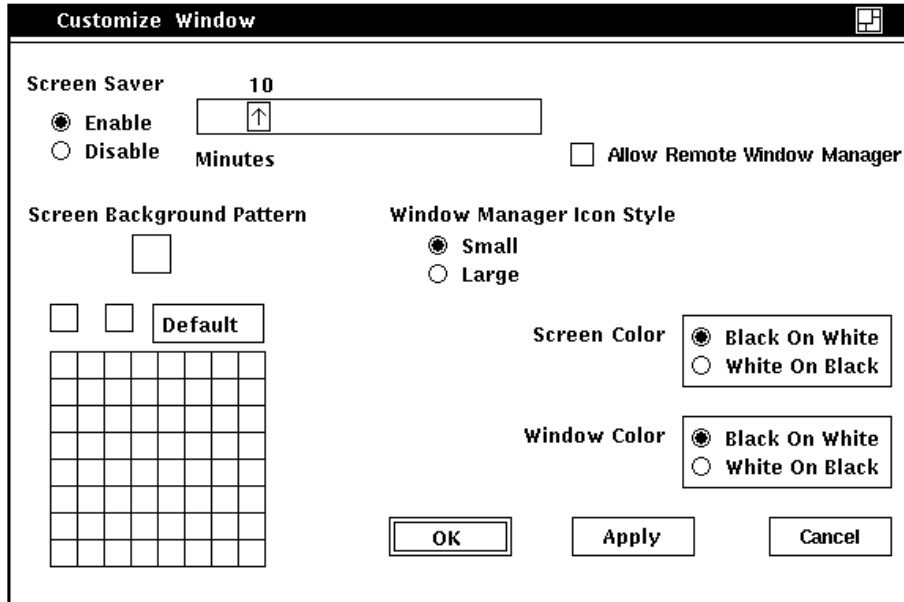

GSF_1051_89.RAGS

Some changes take effect when you click on the **Apply** button or **OK** button in the **Customize Window** dialog box. Others take effect in your next session. See the individual features for details.

From the **Customize Window** dialog box, you can change any of the following settings:

Screen Saver

The **Screen Saver** extends the life of your monitor by shutting off its display after a specified time. Normally, the terminal shuts off its display after 10 minutes of keyboard or mouse inactivity. You can vary the time before the screen goes blank, from 1 to 60 minutes.

- To vary the time the screen saver waits before shutting down the display, drag the arrow in the slider to the right of left, or move the pointer to a spot on the slider and click MB1.
- To keep the display on indefinitely, click on the **Disable** button.
- Click on the **Apply** button or **OK** button to apply your change.

You can check if the screen saver is on by looking at the keyboard indicator lights. The lights blink in a regular pattern when the screen saver is on.

Default: 10 minutes

Allow Remote Window Manager

You can choose whether or not a host-based window manager can take over windowing operations on the screen. The VT1000's local window manager provides you with quicker response time and overall higher performance. However, a host-based window manager may offer more features. To let the host control windowing operations, click on the Allow Remote Window Manager button.

Default: off

Screen Background Pattern

Normally, the screen background pattern is a tight, gray crossweave. To change the background pattern, click on a pattern in the pattern palette. The pattern you select appears in the pattern viewer. Click on the Apply button or OK button to see your selection in effect.

You can also create a solid background by clicking on one of two background pattern buttons next to the Default button.

- Click on the left button to create a solid background in the screen foreground color. For example, if the Screen Color is Black on White on your monochrome system, click on the left button in the Screen Background Pattern to see a solid black background.
- Click on the middle button to create a solid background in the screen background color.

Default: Gray crossweave

Window Manager Icon Style

Normally, the icons stored in the Icon Box are small. Click on the Large button to change the size of the icons. If you save your changes, the Icon Box will contain large icons when you start your next session.

Default: Small

Screen Color

The screen pattern, when set to anything other than the default pattern, consists of a screen foreground (the filled area in the pattern) and a screen background (the pattern's outline).

On your monochrome VT1000 terminal, the screen color is normally black. Click on the White on Black option button to reverse the fill and outline colors.

To see your new setting in effect, click on the Apply button or OK button.

Default: Black on White

Window Color

The Window Color setting controls the color of text or graphics in a window. On your monochrome VT1000 terminal, the window color is normally black. Click on the White On Black button to change the window color to white.

If you save your changes by clicking on the Apply button or OK button, your new setting takes effect when you start your next session.

Default: Black on White

Controlling the Display of Messages

You can choose whether or not to have the terminal display certain messages, such as connection requests. You can choose settings that suit your preference or the needs of your application software. Messages appear in the Messages region of the VT1000 Terminal Manager Window. Choose the Terminal Manager... menu item from the VT1000 Terminal Manager's Customize menu. The Customize Terminal Manager dialog box looks like this:

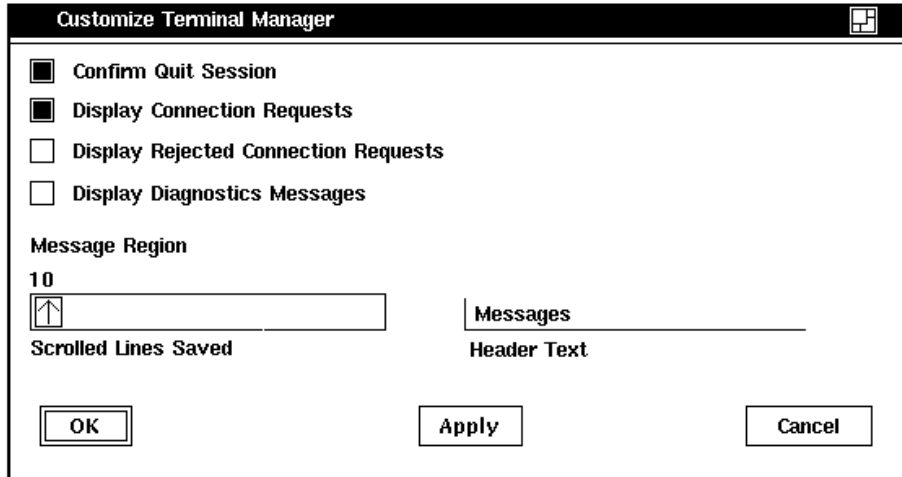

GSF_1368_89.RAGS

From the Customize Terminal Manager dialog box, you can change any of the following settings:

Confirm Quit Session

When you quit a session from the Session menu, the terminal normally asks for confirmation. You can turn this feature on or off by clicking on the Confirm Quit Session toggle button. If you turn this feature off, the terminal ends the current session immediately after you choose Quit from the Session menu.

Default: enabled

Display Connection Requests

The terminal can display connection requests in the Messages region. You can turn this feature on or off by clicking on the Display Connection Requests toggle button.

Default: enabled

Display Rejected Connection Requests

Normally, the terminal does not display rejected connection requests. You can choose to have the terminal display the rejection messages in the Messages region. To turn this feature on or off, click on the Display Rejected Connection Requests toggle button.

Default: disabled

Display Diagnostics Messages

Diagnostic messages indicate any problem with the network server or terminal. Normally, the terminal does not display these messages. You can choose to have the terminal display the diagnostic messages in the Messages region. To turn this feature on or off, click on the Display Diagnostic Messages toggle button.

Default: disabled

Messages Region

You can scroll through text in the Messages region. The Scroll Lines Saved slider lets you specify how many lines scrolled out of the region to save. Any extra lines are lost.

This feature does not affect the size of the Messages region. The width of the Messages region can change if you change the VT1000 Terminal Manager window size.

Header Text

You can specify the text of the header the terminal uses for the Messages region. Just click on the Header Text field, then enter your header. The message header can have up to 30 characters.

Default: Messages

Changing Your Host Port or Printer Port Settings

You can specify the communication settings of the terminal's serial host and printer ports to make them compatible with your host system. The default settings work with most Digital systems. Make sure the settings you use match your host system.

The host port is for connecting to a host system. The printer port is for connecting either to a local printer or a second host. Each port uses a DEC-423, 6-pin connector.

NOTE

You cannot use X windows or DECwindows over the host or printer port. These ports are for traditional terminal communication with host systems. You must use the Ethernet connector to use X windows or DECwindows.

The Customize Host Port and Customize Printer Port dialog boxes are identical, except for a few extra buttons in the Customize Printer Port dialog box.

To change the host port settings, choose the Host Port... menu item from the VT1000 Terminal Manager's Customize menu. The Customize Host Port dialog box looks like this:

To change the printer port settings, choose the Printer Port... menu item from the VT1000 Terminal Manager's Customize menu. The Customize Printer Port dialog box looks like this:

From the Customize Host or Printer Port dialog box, you can change any of the following settings:

Transmit

You can select the speed the terminal uses to send data to the host system or printer. Normally, the terminal's host port uses a speed of 9600 baud, and the printer port uses a speed of 4800 baud. These settings work with most Digital systems. To select another speed, click on the button next to the speed you want.

The VT1000 terminal does not support speeds lower than 300 baud.

Default: 9600 for host port, 4800 for printer port

Receive

You can choose the speed the terminal uses to receive data from the host system or printer. Normally, the terminal's receive speed matches its transmit speed (rx = tx). However, the terminal can transmit at one speed and receive at another. To choose another speed, click on the button next to the speed you want. Make sure you choose a receive speed that matches your host's or printer's transmit speed.

Default: rx = tx

Character Format

You can choose the word size and number of parity bits used to communicate with the host system or printer. The terminal uses a default word size of 8 bits and no parity. This setting works with most of today's computer systems.

Default: 8-bit, No Parity

Stop Bits

You can choose the number of stop bits used in the character format. Digital recommends using one stop bit for most applications. To select two stop bits, click on the Two button.

Default: One

XOFF At

You can choose how many characters the terminal stores in its receive buffer before sending the host or printer an XOFF signal to stop sending data. Normally, the terminal sends XOFF to the host when the input buffer contains 64 characters. See Appendix C for details. To choose 128 characters or no XOFF, click on the appropriate button.

Default: 64

Use as (in Customize Printer Port dialog box only)

Normally, the printer port acts as a printer port. When you use this setting, you can connect a local printer to the terminal for print screen operations. You can choose one of four functions for the printer port:

| Choose . . . | To . . . |
|---------------------|---|
| Host Port | Use the printer port to connect the terminal to a second host system. |
| Printer Port | Use the printer port to connect a local printer. |
| 2-Way Printer Port | Let the printer send control information to the host. |
| Diagnostics Port | Unsupported. |

To choose the Host Port or 2-Way Printer Port settings, click on the appropriate button.

Default: Printer Port

Changing Your LAT Settings

VMS systems use the local area transport (LAT) protocol to connect to the terminal. You can control the list of hosts and services that can connect to your terminal. The terminal uses LAT group codes to identify hosts and services. The terminal can store 256 group codes (0–255). Your system manager can also adjust the performance of LAT connections.

To change LAT settings and adjust performance, choose the LAT... menu item from the VT1000 Terminal Manager's Customize menu. The Customize LAT dialog box looks like this:

From the Customize LAT dialog box, you can change any of the following settings:

Group Codes

The Group Codes scroll box lets you maintain a list of the groups of hosts or services that you want to access. The LAT protocol uses group codes to limit the number of network services that a device must identify and communicate with. On a large local area network, requiring the terminal to communicate with all the available services may overflow the services list in the LAT Terminal Window Service Select or LAT X Session Service Select dialog boxes.

By default, all LAT devices are set to use group code 0 so they can all communicate. In a large network, the network manager can choose to change the group code for some services. For example, the services associated with an engineering group might be in group 1, while the manufacturing group's services are in group 2.

Ask your system manager for your service's group code. If the code is 0, you can use the terminal immediately. If the code is another value, you can add it to the list.

Default: Group Code 0

To add a new group code:

1. Use your keyboard to enter the group code into the text entry field.
2. Click on the Add button. The new group code appears in the Group Codes scroll box.
3. Repeat this procedure for each group code you want to add.

To remove a group code from the list:

1. In the scroll box, click on the group code you want to remove.
2. Click on the Remove button.

To enable all the group codes on your network:

Click on the Add All button to enable the terminal to use all group codes on your network. Remember that the terminal can store a limit of 256 group codes. You should only use this feature if your network has a low number of group codes.

To remove all the group codes from the scroll box:

Click on the Remove All button.

LAT Slide Bars (For System Managers)

You can fine tune the characteristics of your LAT environment by adjusting the four slide bars provided in the Customize LAT dialog box.

See your system manager for the optimal settings of these slide bars. They directly affect the performance of your local area network and should only be adjusted by system management personnel. The slide bars are *not* intended to be randomly set according to the preference of individual users. Poor adjustments can produce poor network and VT1000 terminal performance.

There are four slide bars:

LAT VTE Circuit Timer

You set the LAT VTE Circuit Timer to tune the network for the best response time and network performance when running video terminal (VTE) windows. The optimum setting depends on the number of users on the local area network and the typical network traffic conditions. The normal setting of 80 milliseconds works well with most Digital systems.

Default: 80 milliseconds

LAT X Circuit Timer

You set the LAT X Circuit Timer to tune the network for the best response time and network performance when running an X window or DECwindows session. The optimum setting depends on the number of users on the local area network and the typical network traffic conditions. The normal setting of 30 milliseconds works well with most Digital systems.

Default: 30 milliseconds

Retransmit Limit

To make a LAT connection to a host system, the terminal sends out a request-to-connect message then waits for an acknowledgement. If the host does not acknowledge the request, the terminal resends the message a specified number of times.

The Retransmit Limit tells the terminal how many times to resend the message. If the terminal does not receive an acknowledgement after sending the message the specified number of times, the terminal stops requesting a connection and indicates it could not connect to that host.

Normally, the terminal resends the message eight times before it stops trying to connect. This setting works well with most Digital systems.

Default: 8 times

Keep Alive Timer

When the terminal is inactive, it sends certain LAT messages out on the network every few seconds to keep the LAT connection alive. Normally, the terminal sends messages out every 20 seconds. This setting works well with most Digital systems.

Default: 20 seconds

Changing Your TCP/IP Settings (ULTRIX and UNIX Systems)

ULTRIX and UNIX systems use the TCP/IP protocol to connect to the terminal. From the Customize TCP/IP dialog box, you can enter the terminal's IP address and subnet mask. You can also open dialog boxes for changing the name server and network routing tables.

Choose the TCP/IP... menu item from the VT1000 Terminal Manager's Customize menu. The Customize TCP/IP dialog box looks like this:

From the Customize TCP/IP dialog box, you can change any of the following settings:

Determine IP Address

Clicking on this button makes the terminal determine its IP address, using the UDP/IP BOOTP protocol. BOOTP is an Internet protocol that determines an IP address.

After you click on the Determine IP Address button, a few messages appear in the Messages region of the VT1000 Terminal Manager window, along with the IP address of the terminal. The next time you enter the Customize TCP/IP dialog box, the terminal's IP address appears in the VT1000 IP Address (manual): text entry field.

NOTE

The system manager of a host system running the BOOTP daemon must configure your terminal's hardware and IP address into the BOOTP daemon's configuration file.

TCP/IP Name Server...

Clicking on this button displays the Customize TCP/IP Name Server dialog box. See "Changing Your TCP/IP Name Server Settings" in this chapter.

TCP/IP Routing Tables...

Clicking on this button displays the Customize TCP/IP Routing Tables dialog box. See "Changing Your TCP/IP Routing Table Settings" in this chapter.

VT1000 IP Address (manual):

You can manually enter an IP address for your terminal. See your system manager for an address to use. To enter the address, click on the VT1000 IP Address (manual): text entry field. After you enter an address, click on the OK button to save the address (for this session only) and dismiss the dialog box.

IP Subnet Mask:

You can manually enter an IP subnet mask for your terminal. An IP subnet mask acts as a filter for your TCP/IP network. Using the subnet mask makes the terminal ignore certain traffic on the network.

See your system manager for a subnet mask to use. To enter an IP subnet mask, click on the IP Subnet Mask: text entry field. After you enter the IP subnet mask, click on the OK button to save the mask (for this session only) and dismiss the dialog box.

Changing Your TCP/IP Name Server Settings

If your system has name servers, you can specify host names instead of addresses in the TELNET Terminal Window Host Select dialog box. A name server resolves destination names into network addresses.

You can specify a primary and secondary Berkeley Internet Name Domain (BIND) name server. You can also determine and change the terminal's domain name. See your system manager for your name server's IP address.

Choose the TCP/IP... menu item from the VT1000 Terminal Manager's Customize menu. The Customize TCP/IP dialog box appears. Click on the TCP/IP Name Server... button. If you have not entered an IP address for the terminal in this dialog box, the TCP/IP Name Server... button is dimmed (not selectable). The Customize TCP/IP Name Server dialog box looks like this:

From the Customize TCP/IP Name Server dialog box, you can change any of the following settings:

Primary Name Server

The terminal first attempts to use the primary name server to resolve names entered into fields requiring a host name or IP address.

To enter or change the primary name server, click on the text entry field and enter the primary name server's IP address.

Secondary Name Server

If the terminal cannot resolve a host name or IP address with the primary name server, the terminal queries the secondary name server.

To enter or change the secondary name server, click on the text entry field and enter the secondary name server's IP address.

Determine Domain Name

When you click on this button, the terminal tries to determine its own domain name. You must have previously entered a primary or secondary name server and clicked on the Apply button. Name resolution is not possible without a valid domain name. After determining its domain name, the terminal displays the name in the Domain Name text entry field.

Domain Name

To enter or change the domain name, click on the text entry field and enter the domain name. Example: MYORG.MYCOMP.COM.

Changing Your TCP/IP Routing Table Settings

From the TCP/IP Routing Tables dialog box, you can update the network routing tables. If you have not entered an IP address, the TCP/IP Routing Tables... button is dimmed (not selectable).

Choose the TCP/IP... menu item from the VT1000 Terminal Manager's Customize menu. Click on the TCP/IP Routing Tables... button. The Customize TCP/IP Routing Tables dialog box looks like this:

From the Customize TCP/IP Routing Tables dialog box, you can add or remove a temporary or preferred route. You can save preferred routes for future sessions by using the Save Current Settings menu item from the Customize menu. The terminal does not save temporary routes for future sessions.

Although the Temporary Routes and Preferred Routes boxes only display the route destination, both a destination and a gateway are stored for each entry.

Temporary and Preferred Routes

To add a route:

1. Specify whether the route applies to either a host or a network, by clicking on the Host or Network button. If you click on the Auto button, the terminal tries to determine if the route is for a host or a network.

2. Enter the route's data into the Destination and Gateway text entry fields.
3. Click on the Add box beside the Temporary or Preferred Routes box. You can save preferred routes for future sessions by using the Save Current Settings menu item in the VT1000 Terminal Manager's Customize menu.

To view or change stored data for a route:

Click on the route's destination displayed in the Temporary Routes or Preferred Routes scroll box. The terminal displays the route's destination and gateway in their text entry fields.

To remove a route:

1. Click on the route's destination displayed in the Temporary Routes or Preferred Routes scroll box.
2. Click on the Remove button next to the scroll box.

Changing Your Font Path Settings

A font is a set of characters in a particular type style. The terminal displays characters from a selected font. The terminal has its own set of character fonts, but for some applications you may need to use alternate fonts available on your host system. To find a font file on the host, the terminal needs a font path.

You need to enter a font path before using X window sessions and applications, because the terminal's ROM fonts do not contain all the required fonts. The terminal will allow you to create an X session without a font path, but you will have to quit and restart the terminal to set the font path.

After you make a connection that uses the font path, you cannot change the font path without quitting from the session. The Font Path... menu item is dimmed and not selectable.

You can specify a font path by choosing the Font Path... menu item from the VT1000 Terminal Manager's Customize menu. The Customize Font Path dialog box looks like this:

From the Customize Font Path dialog box, you can change any of the following settings:

Font Path Selection

The Font Path Selection determines which font path is active. If your terminal communicates over the LAT protocol, click on the LAT Font Path button. If your terminal communicates over the TCP/IP or TELNET protocol, click on the TFTP Font Path button.

LAT Font Path

Before you enter a font path, the terminal uses only its own fonts stored in ROM. The first entry in the LAT Font Path field is `ROM`, indicating the terminal is using its own fonts. Always leave the `ROM` entry at the beginning of the field.

If you enter a font path pointing to a node on your system, the terminal uses the font files on that node. You can enter a font path name of up to 30 characters.

To enter a LAT font path:

1. Click on the **LAT Font Path** button under the Font Path Selection title.

2. The LAT Font Path text entry field already has the word `ROM` entered. Enter a comma (,) followed by a font host name and two colons.

Example:

```
ROM, ALPHA : :
```

`ALPHA : :` is the font server name. It can be a node name or a cluster name. You must leave `ROM` at the beginning of the line, followed by a comma, the font server name, and the two colons.

No further specification is needed, unless the system manager moves the fonts out of the default directory created when the windows software and fonts were installed on the system.

Setting a LAT font path may take several minutes. The terminal must wait for the font service to become known. Each time you power up the terminal or restart it by choosing **Quit**, the terminal immediately tries to set the font path that was saved. If the font service is not immediately known, the terminal tries every 30 seconds to set the font path, for up to 2.5 minutes. The LAT default multicast interval is 2 minutes.

When the font service is known, the process of setting the path starts on the next retry. If the font setting does not restart after 2.5 minutes, or if the service becomes known between retries, you can restart it by clicking on **Okay** in the **Customize Font Path** dialog box.

When the font service is known, setting the LAT set font path takes less than a minute. The message `Font Path Succeeded` is displayed in the VT1000 Terminal Manager window's **Messages** region, along with a report of the number of fonts found.

TFTP Font Path

Before you enter a font path, the terminal uses only its own fonts stored in `ROM`. The first entry in the **TFTP Font Path** field is `ROM`, indicating the terminal is using its own fonts. Always leave the `ROM` entry at the beginning of the field.

If you enter a font path pointing to a node on your system, the terminal uses the font files on that node. You can enter a font path name of up to 30 characters.

To enter a TFTP font path:

1. Click on the **TFTP Font Path** button under the **Font Path Selection** title.
2. Click on the **TFTP Font Path** text entry field.

3. The word `ROM` is already entered in the TFTP Font Path text entry field. Use your keyboard to enter a comma (,) followed by a font host IP address. Use the syntax *IP_address::path_name*. See your system manager if you need help.

Example:

```
ROM,123.45.67.89:/vt1000/100dpi/fonts.dir
```

The exact format depends on how your system manager defines the font path. See Appendix D for details.

Each time you power up the terminal or reset it by using a quit function, the terminal tries to set a font path. The terminal must wait for the font service to become known before it begins to set the path. While setting the path, the terminal displays a clock cursor. All other terminal activity halts until the path is set.

Tips on Setting Font Paths

The time needed to set a font path depends on how many fonts are in the font path. To lessen the time to set a font path:

- Point only to the font files that support the resolution of your monitor.
- In a mixed LAT and TCP/IP environment, use a LAT system for the font service.
- In a non-DECwindows environment, point only to the files needed for your application.

System managers should see Appendix D for instructions on creating files and configuring systems for font paths. Note that the font path in the previous example is based on a restricted TFTP setup in the system configuration file.

8

The Keyboard

This chapter describes the basic function of each keyboard key and indicator. Chapter 9 describes how to type additional characters not shown on the keys.

LK401 Keyboard

The VT1000 terminal uses Digital's LK401 keyboard. The LK401 keyboard comes in many versions for use with different languages and dialects. The only physical difference between these keyboards are the legends on the keys.

The figures in this chapter show the North American/United Kingdom keyboard, unless otherwise noted.

Keyboard Dialect

The VT1000 is initially set to work with the North American/United Kingdom keyboard. If you have a keyboard for a different language or you want to use the British dialect, you must change the **Keyboard Type** setting in the Customize Keyboard dialog box. See "Changing Your Keyboard Settings" in Chapter 7.

Layout

The LK401 keyboard has four groups of keys and two visual indicators. The keys are grouped by function.

- Main keypad
- Editing keypad
- Numeric keypad
- Top-row function keys

The LK401 keyboard also has two audible indicators, a keyclick and bell.

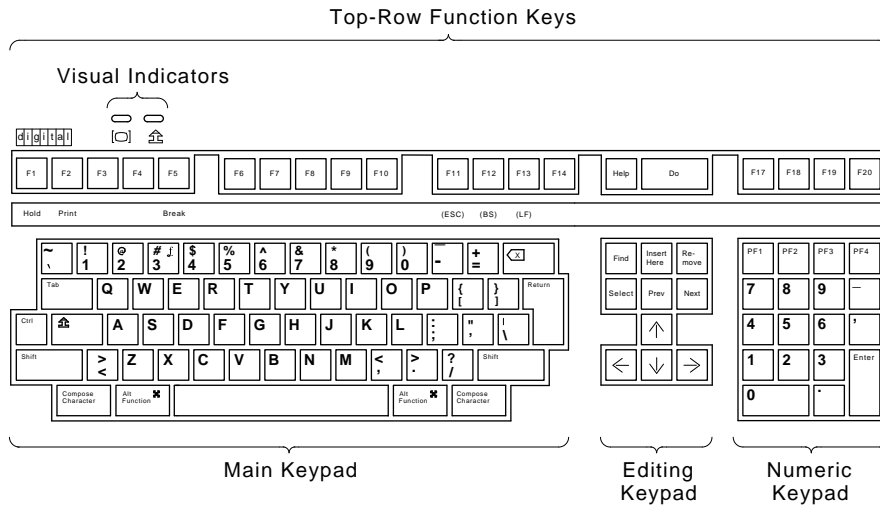

GSF_1436_89.DG

Main Keypad

The main keypad is similar to a typewriter keyboard with alphanumeric characters, punctuation marks, and **Shift** keys. The main keypad also has a number of keys not found on a standard typewriter, such as the **Ctrl** modifier key and the **Compose Character** and **Alt Function** prefix keys. The German keyboard has a **Group Shift** key and **Alternate Shift** key instead of **Compose Character** keys.

Modifier keys are pressed in combination with another key, to modify the code sent by that key. *Prefix keys* are pressed and released before pressing another key, to change the function of one or more keystrokes.

Special-Function Keys

The main keypad has the following special-function keys:

Tab

Pressing **Tab** in a VTE sends a horizontal tab, which normally moves the cursor to the next tab stop. Applications can change tab stops. In the VT1000 Terminal Manager screens and in some DECwindows menus, **Tab** moves the cursor to the next text entry field.

Ctrl

Holding down **Ctrl** and pressing another key sends a control code to the host.

For example, **Ctrl Z** means to hold down **Ctrl** and press the **Z** key.

Shift

There are left and right **Shift** keys. Holding down **Shift** and pressing a standard key sends the shifted (top) character on the key.

Holding down **Shift** and pressing a special-function key starts a predefined control function. For example, **Shift F2** (Print) means to hold down **Shift** while pressing the **F2** (Print) key.

Lock

Pressing the lock key down puts the keyboard in caps lock mode or shift lock mode. You can set the mode from the Customize Keyboard dialog box (Chapter 7). The default setting is Caps Lock.

- In caps lock mode, the alphabetic keys send their uppercase or shifted character when pressed alone. You can use a **Shift** key to send the shifted character on other keys. You turn caps lock mode on and off by pressing and releasing the lock key.
- In shift lock mode, all keys on the main keypad send their shifted character. You can turn shift lock mode on or off by pressing the **Lock** key.

When the lock key is down, the lock indicator on the keyboard turns on.

Return

Pressing **Return** sends either a carriage return or a carriage return and a line feed (newline). You can select the function of the **Return** key from the Customize General dialog box (Chapter 5).

<x
Backarrow
key

Pressing the **<x** key normally sends a delete (DEL) character. Many applications use DEL to erase one character to the left of the cursor.

You can make the **<x** key send a backspace (BS) character instead of DEL. You can select the function of the **<x** key from the Customize VTE Keyboard dialog box (Chapter 5).

Space bar

Pressing the space bar sends a space (SP) character. You use spaces to separate words or move the cursor forward.

These are prefix keys, used to generate characters that do not appear as standard keys on your keyboard. See Chapter 9.

**Compose
Character**
(left and
right)

On the German keyboard, the **Compose Character** key is replaced by **Group Shift** and **Alternate Shift**.

You use **Group Shift** as a prefix or modifier key, to type the characters on the right half of keycaps. See Chapter 9.

**Group
Shift**
**Alternate
Shift**
(German)

Alternate Shift is a modifier key, used to generate a no break space (NBSP) or soft hyphen (SHY) character.

Alternate Shift + space bar = NBSP character.

Alternate Shift + **-** = SHY character.

You use **Alt Function** with other keys, to select alternate functions defined by your application software.

**Alt
Function**
(left and
right)

You can use **Alt Function** as a **Compose Character** key, by holding down the space bar and pressing **Alt Function**. This action starts a compose character sequence.

For example, Digital's workstations use the LK201 keyboard, which has a **Compose** key. The VT1000 uses the LK401 keyboard, which has both **Compose Character** and **Alt Function** keys. If a workstation application's documentation specifies use of the **Compose Character** key as a modifier for keyboard keys or mouse buttons, you may need to use the **Alt Function** key instead on the VT1000.

Editing Keypad

The editing keypad has four arrow keys and six editing keys.

Pressing an arrow key normally moves the text cursor in the direction of the arrow. For example, pressing the **↓** key moves the cursor down one line.

If you press **Ctrl F3**, you can use the editing keypad to perform some mouse functions. In this mode, the arrow keys move the mouse pointer. The **Select**, **Prev**, **Next** keys correspond to the three mouse buttons. The mouse continues to operate. There is no indication the mode is on, but the arrow keys will not work for normal editing functions.

To turn this mode off, press **Ctrl F3** again.

The six editing keys generally perform screen control functions defined by application software.

Numeric Keypad

Numeric keypad keys often have functions assigned by your software applications, especially **PF1** to **PF4**. For example, you may use a spreadsheet program that assigns special functions to these keys. See your application manuals for details.

You can use the numeric keypad to enter numeric data as you would with a calculator. Programmers can use this keypad to do hexadecimal compose sequences. See “Hexadecimal Key Sequences” at the end of Chapter 9.

When you use video terminal (VTE) windows, you can set the function of the keypad as a numeric keypad or application keypad. See the Customize General dialog box in Chapter 5.

Enter

The **Enter** key on the numeric keypad normally works like the **Return** key. **Enter** sends a carriage return, or a carriage return and a line feed. You can select the function of the **Return** key from the Customize General dialog box (Chapter 5).

Application software may use **Enter** as a special-function key.

Top-Row Function Keys

Predefined Keys

The first five top-row keys, **F1** to **F5**, are predefined to perform the following functions. You cannot change these functions. Your application software defines the functions of the remaining top-row keys. See your application manual for details.

F1 (Hold) Pressing **F1** (Hold) puts the screen display in the active window on hold. This stops the scrolling of text, which can make reading easier. When you press **F1** (Hold), the hold indicator on the keyboard turns on. Pressing **F1** (Hold) again allows scrolling to resume.

F2 (Print) Pressing **F2** (Print) sends the text in the active window to the printer.

The output may or may not correspond exactly to the display in the window. The output depends on the window size and font size. See Chapter 5 for more information on printing.

Ctrl F2 Pressing **Ctrl F2** (Print) turns auto print mode on or off. In auto print mode, you can automatically print each line of text as it is received from the host system.

F3 This key is disabled.

Ctrl F3 Pressing **Ctrl F3** lets you use the editing keypad to perform some mouse functions. In this mode, the arrow keys move the mouse pointer. The **Select**, **Prev**, and **Next** keys correspond to the three mouse buttons. The mouse continues to operate. There is no indication the mode is on, but the arrow keys will not work for normal editing functions.

To turn this mode off, press **Ctrl F3** again.

F4 This key is disabled.

F5 (Break) Pressing **Break** ends communication with your system if you are using a VTE window running over the serial communication line.

Pressing **F5** (Break) has no effect on LAT or TCP/IP connections.

Shift **F5**

Pressing **Shift** **F5** (Break) performs a disconnect on the serial communications port associated with the current session. A disconnect is normally used to end communication with a modem in preparation for another call.

Ctrl **F5**

Pressing **Ctrl** **F5** (Break) sends the answerback message to the system, regardless of the communications channel used.

NOTE

Ctrl **F5** (Break) sends the answerback message even if you set the **Conceal Answerback Message** in the **Customize General** dialog box (Chapter 5).

User-Defined Keys and Application-Specific Keys

The function of the remaining top-row keys, **F6** to **F20**, often depends on your application software. Refer to your application software manuals for a description of key functions. You can also define the function of these keys yourself.

F6 to **F20**

When pressed alone, these keys send predefined programming sequences to the host system (Chapter 10). Applications that recognize these sequences can use the keys to perform various functions.

In VT100 and VT52 modes

Keys **F11**, **F12**, and **F13** send control characters ESC, BS, and LF respectively. Keys **F6** to **F10** and **F14** to **F20** do not function.

Shift **F6**

to

Shift **F20****User-defined keys (UDKs)**

Pressing **Shift** and one of these keys sends the user-defined function for that key. You can define keys **F6** to **F20** by using programming sequences. You can use any sequence of characters in your definitions. Definitions are loaded from the host system. See the Chapter 10 for details.

Data Processing Keys

Most versions of the LK401 keyboard have some keys with characters on the left half and right half of their keycap. Normally, you use the characters on the left half of the key. These are called typewriter characters. The characters on the right half are for data processing use.

You can set these keys to send their typewriter or data processing characters, by choosing the keyboard mode. See “Changing Your Keyboard Settings” in Chapter 7.

For the following keyboard types, the typewriter and data processing settings are identical:

- North American and Dutch
- When using 8-bit multinational characters: British, German, and Portuguese

If you use 7-bit national replacement character sets (NRCs), make sure you have chosen the correct NRC to match your keyboard. All data processing keyboards, regardless of language, expect the US ASCII character set to be chosen. See “Choosing National Replacement Character Sets” in Chapter 5.

Key

The North American/United Kingdom standard keyboard has only one key with three characters.

To use the £ symbol, you choose the British Keyboard type. To use the # symbol, you choose the North American Keyboard type. There are no separate data processing legends on the North American/United Kingdom keyboard.

Compose Characters

You can type compose sequences to display many more characters than those shown on the keycaps. For example, you can display accented letters. Chapter 9 describes how to use compose sequences.

Indicator Lights

The keyboard has two indicator lights that work with the  (Hold) and lock keys. The indicator lights are at the upper-left of the keyboard.



Turns on or off when you press the  (Hold) key.



Turns on or off when you press the lock key.

Audible Indicators

The keyboard has two audible indicators, a keyclick and a bell. You can use the bell as a margin bell, warning bell, or both. You can turn off the keyclick and bell, or adjust their volume. See the Customize Keyboard dialog box (Chapter 7).

Keyclick

You hear the keyclick sound each time you press a key that sends a code or causes the terminal to take some immediate action. `[Shift]` and `[Ctrl]` never click. If a key is autorepeating, the keyclick will repeat once for each character or key sequence sent. You can turn off the keyclick in the Customize Keyboard dialog box.

Bell

The bell tone is a beeping sound. You can use the bell as a margin bell, warning bell, or both.

Margin Bell

This bell sounds when the cursor is eight characters from the right margin.

Warning Bell

This bell sounds for any of the following conditions:

- During the power-up self-test
- When the terminal receives a bell (BEL) character from the host system
- After a compose character error
- After pressing a key for a character that is not available in the current character set

9

Typing Additional Characters

The VT1000 terminal lets you type more characters than appear on your keyboard. For example, you can type accented characters or a © symbol. This chapter lists the available characters and shows you how to select them.

To enter one of these characters, you type a sequence of keys. Most sequences begin with one of the `Compose Character` keys. If you use the German keyboard, you use the `Group Shift` key instead of `Compose Character`.

This chapter describes the following types of key sequences:

- Three-stroke `Compose Character` sequences (with all LK401 keyboards)
- `Group Shift` sequences (with the German keyboard)
- Two-stroke key sequences (with keyboards that have nonspacing diacritical keys)
- Hexadecimal key sequences (for programmers)

Two basic factors determine the key sequences you can use.

- The Keyboard Type and Keyboard Mode settings, which should match your keyboard type (Chapter 7).
- The character set the terminal is currently using (Chapter 5).

What Characters Can I Type?

You can type any of the characters in the character set the terminal is currently using. You can select from two multinational sets (DEC Multinational or ISO Latin Alphabet No. 1) or many national replacement character sets (NRCs). The Customize VTE General dialog box lets you set the terminal to work with 8-bit multinational sets or 7-bit NRC sets. If you choose 7-bit NRC sets, the Customize VTE 7-Bit NRCS Selection dialog box (Chapter 5) lets you choose a specific NRC set.

By default, the terminal uses the DEC Multinational character set. Chapter 5 describes multinational and national character sets.

Key Sequences with Nonspacing Diacritical Keys

Table 9–1 lists the keyboards that have keys with *diacritical marks*. Table 9–2 lists all the additional characters for all character sets in the terminal. Many of these characters include a diacritical mark. For example, Å includes an acute accent.

To enter a character that has a diacritical mark, you press the diacritical key followed by the character. If your keyboard does not have the diacritical key, you must press the Compose Character key followed by the correct key sequence listed in Table 9–2.

To use diacritical keys, you must be using a multinational character set.

Table 9–1 Keyboards with Diacritical Marks

| Keyboard | Grave Accent | Acute Accent | Circumflex Accent | Tilde Mark | Umlaut |
|-----------------|--------------|--------------|-------------------|------------|--------|
| Finnish | yes | no | yes | yes | no |
| Flemish | yes | no | yes | yes | yes |
| French/Belgian | yes | no | yes | yes | yes |
| French Canadian | yes | no | yes | yes | no |
| German | yes | yes | yes | yes | yes |
| Portuguese | no | no | no | yes | no |
| Spanish | yes | yes | yes | yes | yes |
| Swedish | yes | no | yes | yes | no |
| Swiss (French) | yes | no | yes | yes | yes |
| Swiss (German) | yes | no | yes | yes | yes |

How to Type a Character Using the Compose Character Key

To enter a key sequence:

1. Find the character you want to type in Table 9-2.
2. Press the key.
3. Type the sequence in Table 9-2 for the character you want.

Example

To type an é:

1. Find the é character in Table 9-2.
2. Press .
3. Type and (apostrophe).

NOTE

If you try to enter a character that is not available in the current character set, a warning bell sounds. See “Invalid Sequences” in this chapter.

How to Type a Character Using the Group Shift Key

If you select the Austrian-German keyboard type in the Customize Keyboard dialog box (Chapter 7), the key replaces the key.

Many keys on the German keyboard have a second group of legends on the right half of their keycap. These legends are called Group-2.

To enter a single character from Group-2:

1. Press and release the key.
2. Type the key that has the desired character on the right half of the keycap. The character appears on the screen.

Example

To type an ø:

1. Press Group Shift.
2. Type the key that has the ø character on the right half of the keycap:
O ø.

To enter a series of characters from Group-2:

1. Hold down the Group Shift key.
2. Type the series of keys that have the desired characters on the right half of their keycaps. The characters appear on the screen.
3. When you are done typing characters from Group-2, release the Group-Shift key.

Invalid Sequences

When you complete a valid compose or group-shift sequence, the character appears on the screen. If you use an invalid sequence, the terminal cancels the sequence and sounds the warning bell.

Some compose characters require that you type the key sequence in the order listed in Table 9–2. If you do not follow the order, the sequence is invalid and the warning bell sounds. If the terminal does not display the character, repeat the sequence exactly as shown in Table 9–2.

NOTE

Pressing a function key cancels a compose or group-shift sequence without sounding the bell.

You can turn the warning bell on or off from the Customize Keyboard dialog box (Chapter 7).

Canceling or Restarting a Key Sequence

If you accidentally start a key sequence by pressing Compose Character, Group Shift, or a nonspacing diacritical key, press the <X> key. This immediately cancels the sequence.

If you press Compose Character during a compose sequence, a new three-stroke sequence starts from that point. The first sequence is canceled.

If you press any of the following keys during a key sequence, they cancel the sequence and perform their usual function:

- `Tab`
- Any top-row key
- `Enter`
- Any `Ctrl` `other key` combination

Hexadecimal Key Sequences

This feature is primarily for programmers who are familiar with character coding and hexadecimal representation.

The terminal uses coded character sets to exchange data with a host computer. The code for a character can be represented by a pair of hexadecimal digits. With the VT1000, you can enter any 8-bit code by pressing `Compose Character` or `Group Shift` followed by two hexadecimal digits typed on the numeric keypad.

When you press `Compose Character` or `Group Shift`, the terminal assigns hexadecimal values to the numeric keypad keys. The character set tables in Chapter 10 show you the hexadecimal values for each character in the standard character sets. Here are the values assigned to each key:

Hexadecimal Compose Keys

| | | | |
|-----|-----|-----|-------|
| PF1 | PF2 | PF3 | PF4 |
| 7 | 8 | 9 | - |
| 4 | 5 | 6 | , |
| 1 | 2 | 3 | Enter |
| 0 | | . | |

| <u>Key Name</u> | <u>Hexadecimal Digit</u> |
|-----------------|--------------------------|
| PF1 | A |
| PF2 | B |
| PF3 | C |
| PF4 | D |
| Minus | E |
| Comma | F |

GSF_0643_89.DG

NOTE

The 8-Bit Characters, 7-Bit Characters, and UPSS DEC Supplemental buttons in the Customize VTE General dialog box do not affect hexadecimal compose sequences.

Examples

- You can use a hexadecimal compose sequence to send the US (unit separator) control character. The hexadecimal value for US is 1F.
 1. Press or .
 2. Press on the numeric keypad.
 3. Press on the numeric keypad.
- You can use a hexadecimal compose sequence to send the DCS (device control string) character. The hexadecimal value for DCS is 90.
 1. Press or .
 2. Press on the numeric keypad.
 3. Press on the numeric keypad.

Invalid Hexadecimal Sequences

If you enter an invalid sequence, the terminal cancels the sequence and sounds the warning bell. You can turn the warning bell on or off from the Customize Keyboard dialog box (Chapter 7).

Table 9–2 Key Sequences for Additional Characters

| Character | Sequence | Character | Sequence |
|------------------|--------------------------------|------------------|-----------------------------|
| " | quotation mark ` (sp) | ± | plus or minus sign + - |
| # | number sign ++ | ² | superscript 2 2 ^ |
| ' | apostrophe ´ (sp) | ³ | superscript 3 3 ^ |
| @ | commercial at A A | μ | micro sign / U |
| [| opening bracket ((| ¶ | paragraph sign P! |
| \ | backslash // or / < | · | middle dot . ^ |
|] | closing bracket)) | ¹ | superscript 1 1 ^ |
| ^ | circumflex accent ^ (sp) | º | masculine ordinal O_ |
| ` | grave accent ` (sp) | » | closed angle brackets >> |
| { | opening brace (- | ¼ | fraction one-quarter 1 4 |
| | vertical line / ^ | ½ | fraction one-half 1 2 |
| } | closing brace) - | ¿ | inverted ? ?? |
| ~ | tilde ~ (sp) | À | A grave `A |
| ¡ | inverted ! !! | Á | A acute ´A |
| ¢ | cent sign C / or C | Â | A circumflex ^A |
| £ | pound sign L- or L= | Ã | A tilde ~A |
| ¥ | yen sign Y- or Y= | Ä | A umlaut ¨A or "A |
| § | section sign SO or S! or S0 | Å | A ring °A or *A |
| ¤ | currency sign XO or X0 | | (degree sign) |
| © | copyright sign CO or C0 | Æ | A E diphthong AE |
| ª | feminine ordinal A_ | Ç | C cedilla C, |
| « | open angle brackets < < | È | E grave `E |
| ° | degree sign 0 ^ | É | E acute ´E |

Most sequences that include diacritical marks can also be typed in reverse order.

Table 9–2 (Cont.) Key Sequences for Additional Characters

| Character | Sequence |
|------------------|-------------------------|
| Ê | E circumflex ^E |
| Ë | E umlaut "E or "E |
| Ì | I grave `I |
| Í | I acute 'I |
| Î | I circumflex ^I |
| Ï | I umlaut "I or "I |
| Ñ | N tilde ~ N |
| Ò | O grave `O |
| Ó | O acute 'O |
| Ô | O circumflex ^O |
| Õ | O tilde ~O |
| Ö | O umlaut "O or "O |
| Œ | O E diphthong* O E |
| Ø | O slash o / |
| Ù | U grave `U |
| Ú | U acute 'U |
| Û | U circumflex ^U |
| Ü | U umlaut "U or "U |
| ÿ | Y umlaut* "Y or "Y |
| ß | German small sharp s ss |
| à | a grave `a |

| Character | Sequence |
|------------------|----------------------------------|
| á | a acute 'a |
| â | a circumflex ^a |
| ã | a tilde ~a |
| ä | a umlaut "a or "a |
| à | a ring °a or a* (degree sign) |
| æ | a e diphthong a e |
| ç | c cedilla c , (comma) |
| è | e grave `e |
| é | e acute 'e |
| ê | e circumflex ^e |
| ë | e umlaut "e or "e |
| ì | i grave `i |
| í | i acute 'i |
| î | i circumflex ^i |
| ï | i umlaut "i or "i |
| ñ | n tilde ~n |
| ò | o grave `o |
| ó | o acute 'o |
| ô | o circumflex ^o |
| õ | o tilde ~o |
| ö | o umlaut "o or "o |
| œ | o e diphthong* o e |

*This character is only available when you use the DEC Multinational Character Set. See the Customize VTE General dialog box (Chapter 5).

Table 9–2 (Cont.) Key Sequences for Additional Characters

| Character | Sequence |
|-----------|--------------|
| ø | o slash |
| ù | u grave |
| ú | u acute |
| û | u circumflex |
| ü | u umlaut |
| ÿ | y umlaut* |

ISO Characters†

| | |
|---|------------------------|
| | no break space |
| | broken vertical bar |
| ¬ | logical not |
| - | soft (syllable) hyphen |
| ® | registered trademark |
| - | macron |

| | |
|---|---------------------|
| ¾ | three quarters |
| ÷ | division sign |
| × | multiplication sign |

| Character | Sequence |
|-----------|-------------------------|
| ´ | acute accent |
| ¸ | cedilla |
| ¨ | diaeresis |
| Ý | Y acute |
| ý | y acute |
| Ð | capital Icelandic thorn |
| þ | small Icelandic thorn |
| Ð | capital Icelandic Eth |
| ð | small Icelandic Eth |

*This character is only available when you use the DEC Multinational Character Set. See the Customize VTE General dialog box (Chapter 5).

†These characters are only available when you use the ISO Latin Alphabet No. 1 character set. See the Customize VTE General dialog box (Chapter 5).

10

VT1000 Programming Summary

The VT1000 video terminal (VTE) windows emulate a VT320 text terminal. When programming for VTE windows, you can use the control functions and commands described in the *VT320 Programmer Reference Manual*. This chapter describes additional control functions and commands for the VT1000 terminal that you can use when programming VTE windows. The chapter has two main sections.

- **Locator Device Commands** provides a detailed description of the commands you use to program the locator device attached to the VT1000 terminal. The locator device can be a mouse or graphics tablet.
- **Programming Summary** summarizes the control functions specific to the VT1000 terminal. If you are a programmer, you can use this as a quick-reference tool. For more background on these control functions, see the *VT320 Programmer Reference Manual*.

Locator Device Commands

This section describes the commands you use to program the locator device attached to the terminal. The locator device can be a mouse or graphics tablet. There are four locator device commands:

- Enable filter rectangle
- Enable locator reports
- Locator report
- Select locator events

Enable Filter Rectangle (DECEFR)

This control function defines the coordinates of a *filter rectangle*, then activates it. If the terminal detects that the locator is outside the filter rectangle, the terminal sends an outside rectangle event and disables the rectangle. The terminal treats filter rectangles as one-shot events. Defining a new rectangle reactivates it.

Format

```
CSI  Pt  ;    Pl; Pb; Pr  '  w
9/11 3/? 3/11 ***** 2/7 7/7
```

Parameters

Pt
is the top border of the filter rectangle.

Pl
is the left border.

Pb
is the bottom border.

Pr
is the right border.

Description

Pt, *Pl*, *Pb*, and *Pr* are in coordinate units specified in the last DECEFR sequence. The filter rectangle includes the borders. The origin of the rectangle is the upper-left corner (*Pt* = 1, *Pl* = 1). If you omit any parameters, they default to the current locator position. Sending DECEFR without any parameters informs the application of any locator movement (unfiltered movement).

You can redefine the rectangle at any time, even if it is already active. If you define a rectangle that does not contain the locator cursor, the terminal sends an outside rectangle report and deactivates the rectangle.

DECEFR always cancels any previous filter rectangle definition. This action ensures that there will never be an outstanding filter rectangle when an application enables locator reports.

Enable Locator Reports (DECELRL)

This control function enables or disables the sending of locator reports from the terminal to the application. When enabled, you can program individual locator events to send reports to the host. An event can be (1) movement of the locator device, or (2) the pressing or releasing of a locator button, which is called a *transition*.

Format

CSI *Ps* ; *Pu* ' **z**
9/11 3/? 3/11 3/? 2/7 7/10

Parameters

Ps

specifies whether or not locator reports are enabled.

| <i>Ps</i> | Meaning |
|-----------|---------|
|-----------|---------|

| | |
|---|---|
| 0 | Locator reports disabled (default) |
| 1 | Locator reports enabled |
| 2 | One-shot reports (Send one report, then disable.) |

Pu

specifies the coordinate units for locator reports.

| <i>Pu</i> | Coordinate Units |
|-----------|------------------|
|-----------|------------------|

| | |
|--------------|---------------------------|
| 0 or omitted | Character cells (default) |
| 1 | Device physical pixels |
| 2 | Character cells |

Locator Report (DECLRP)

The terminal sends locator reports to the host when a locator event occurs. A locator event can be (1) movement of the locator device, or (2) the pressing or releasing of a locator button, which is called a transition.

When a selected trigger event occurs, such as pressing or releasing a button, the terminal sends a locator report (DECLRP) to the host. The locator report tells the host the current position of the locator and which event triggered the report.

NOTE

The terminal only sends locator reports to the host when the enable locator reports (DECELRLR) command is set to enabled.

Format

```
CSI  Pe  ;  Pb; Pr; Pc; Pp  &  w  
9/11 3/? 3/11 ***** 2/6 7/7
```

Parameters

Pe

is the event code. *Pe* indicates which event caused the terminal to send this report.

| <i>Pe</i> | Meaning |
|-----------|--|
| 0 | Request. The terminal received an explicit request for a locator report, but the locator is unavailable. |
| 1 | Request. The terminal received an explicit request for a locator report. |
| 2 | Left button down |
| 3 | Left button up |
| 4 | Middle button down |
| 5 | Middle button up |
| 6 | Right button down |
| 7 | Right button up |
| 8 | Fourth button down |

- 9 Fourth button up
- 10 Locator outside of filter rectangle

Pb

is the button code. This code is an ASCII decimal number from 0 to 15 that indicates which buttons are down. The state of the four buttons on the locator correspond to the low four bits of the decimal value. For example, 1 means the button is down.

| Pb | Button Down |
|-----------|--------------------|
| 0 | No buttons down |
| 1 | Right |
| 2 | Middle |
| 4 | Left |
| 8 | Fourth |

Pr

is the row coordinate of the locator position on the page. *Pr* is encoded as an ASCII decimal value.

Pc

is the column coordinate of the locator position in the page. *Pc* is encoded as an ASCII decimal value.

Pp

is the page number of the locator position. The VT1000 terminal does not use *Pp*, because it only has one page. *Pp* is encoded as an ASCII decimal value. If *Pp* is omitted, the terminal uses a default of 1.

Request Locator Position (DECRQLP)

This control function requests a locator position report.

Format

| | | | |
|------------|-----------|-----|------|
| CSI | <i>Ps</i> | ' | |
| 9/11 | 3/? | 2/7 | 7/12 |

Parameters

Ps

Selects how the terminal sends the locator position report.

| <i>Ps</i> | Meaning |
|-----------|---------|
|-----------|---------|

| | |
|--------------|---|
| 0 or omitted | Send a single locator position report (DECLRP). |
|--------------|---|

| | |
|---|------------|
| 1 | Same as 0. |
|---|------------|

Description

The host can explicitly request a locator report only when enable locator reports (DECELR) is set to enabled. The request causes the terminal to immediately send a locator report to the host. The report has an event code of 1, indicating the last locator position. If the session receiving the request is not currently active, the terminal sends the last known locator position for that session. If the locator is disabled or unavailable, the report has an event code of 0.

Select Locator Events (DECSLE)

This control function selects which locator events cause the terminal to send a report to the host.

Format

```
CSI  Ps . . . Ps  '  {  
9/11  *****  2/7  7/11
```

Parameters

Ps...Ps

are one or more parameters that select which locator events cause the terminal to send a report.

| <i>Ps</i> | Meaning |
|-----------|---|
| 0 | Respond only to explicit host requests. (default) Also cancels any pending filter rectangle. |
| 1 | Send a report when locator buttons are pressed. |
| 2 | Do not send a report when locator buttons are pressed. |
| 3 | Send a report when locator buttons are released. |
| 4 | Do not send a report when locator buttons are released. |

Description

DECSLE lets you select which locator events the terminal reports to the host. The locator can report both up and down (released and pressed) button transitions for those situations where the exact sequence of button actions is significant.

Programming Summary

The *VT320 Programmer Reference Manual* describes most of the control functions you can use when programming the VT1000 terminal in video terminal extended (VTE) mode. This section summarizes other control function information that is either specific to the VT1000 terminal or not used with the VT320 terminal. Programmers can use this section as a quick-reference tool.

The following sections are numbered to correspond to the chapters in the *VT320 Programmer Reference Manual*. For example, to find out more about **Character Encoding**, you would go to Chapter 2 of the *VT320 Programmer Reference Manual*.

2 Character Encoding

DEC Technical Character Set

The DEC Technical character set is a 7-bit character set with 94 graphic characters. It includes characters and symbols often used in technical applications, such as schematic and logic diagrams.

The C0 controls are in columns 0 and 1 of the DEC Technical character set.

The graphic characters and symbols are in columns 2 through 7.

You can use the characters in positions 2/1 through 3/7 to form large composite characters.

You can use the DEC Technical set to replace the ASCII set in GL or the DEC Supplemental Graphic set in GR. You can only use the DEC Technical set in VT300 mode.

VT1000 VTE Programming Summary 177

| b8 b7 b6 b5 Bits | 0 0 | | 0 1 | | 1 0 | | 1 0 | | 0 1 | | 0 1 | | 0 1 | | 1 1 | | |
|------------------------------|--------|---|----------------|------------------|----------------|------------------|-----|-----------------|------------------|----|-----------------|----|------------------|------------------|-----|------------------|------------------|
| | Column | | 2 | 10 | 3 | 11 | 4 | 12 | 5 | 13 | 6 | 14 | 7 | 15 | | | |
| | Row | | | | | | | | | | | | | | | | |
| 0 0 0 0 | 0 | | | ┌ | 60 48 30 | 260 176 90 | · | 100 64 40 | 300 192 C0 | Π | 120 80 50 | ┐ | 140 96 60 | 340 224 E0 | π | 160 112 70 | 360 240 F0 |
| 0 0 0 1 | 1 | └ | 41 33 21 | 241 161 A1 | 61 49 31 | 261 177 B1 | · | 101 65 41 | 301 193 C1 | Ψ | 121 81 51 | ┌ | 141 97 61 | 341 225 E1 | ψ | 161 113 71 | 361 241 F1 |
| 0 0 1 0 | 2 | ┌ | 42 34 22 | 242 162 A2 | 62 50 32 | 262 178 B2 | ∞ | 102 66 42 | 302 194 C2 | | 122 82 52 | β | 142 98 62 | 342 226 E2 | ρ | 162 114 72 | 362 242 F2 |
| 0 0 1 1 | 3 | — | 43 35 23 | 243 163 A3 | 63 51 33 | 263 179 B3 | ÷ | 103 67 43 | 303 195 C3 | Σ | 123 83 53 | χ | 143 99 63 | 343 227 E3 | σ | 163 115 73 | 363 243 F3 |
| 0 1 0 0 | 4 | ┌ | 44 36 24 | 244 164 A4 | 64 52 34 | 264 180 B4 | Δ | 104 68 44 | 304 196 C4 | | 124 84 54 | δ | 144 100 64 | 344 228 E4 | τ | 164 116 74 | 364 244 F4 |
| 0 1 0 1 | 5 | └ | 45 37 25 | 245 165 A5 | 65 53 35 | 265 181 B5 | ∇ | 105 69 45 | 305 197 C5 | | 125 85 55 | ε | 145 101 65 | 345 229 E5 | f | 165 117 75 | 365 245 F5 |
| 0 1 1 0 | 6 | ┌ | 46 38 26 | 246 166 A6 | 66 54 36 | 266 182 B6 | Φ | 106 70 46 | 306 198 C6 | √ | 126 86 56 | φ | 146 102 66 | 346 230 E6 | ς | 166 118 76 | 366 246 F6 |
| 0 1 1 1 | 7 | └ | 47 39 27 | 247 167 A7 | 67 55 37 | 267 183 B7 | Γ | 107 71 47 | 307 199 C7 | Ω | 127 87 57 | γ | 147 103 67 | 347 231 E7 | ω | 167 119 77 | 367 247 F7 |
| 1 0 0 0 | 8 | ┌ | 50 40 28 | 250 168 A8 | 70 56 38 | 270 184 B8 | ~ | 110 72 48 | 310 200 C8 | Ξ | 130 88 58 | η | 150 104 68 | 350 232 E8 | ξ | 170 120 78 | 370 248 F8 |
| 1 0 0 1 | 9 | └ | 51 41 29 | 251 169 A9 | 71 57 39 | 271 185 B9 | ≅ | 111 73 49 | 311 201 C9 | Τ | 131 89 59 | ι | 151 105 69 | 351 233 E9 | υ | 171 121 79 | 371 249 F9 |
| 1 0 1 0 | 10 | ┌ | 52 42 2A | 252 170 AA | 72 58 3A | 272 186 BA | θ | 112 74 4A | 312 202 CA | Ϸ | 132 90 5A | θ | 152 106 6A | 352 234 EA | ζ | 172 122 7A | 372 250 FA |
| 1 0 1 1 | 11 | └ | 53 43 2B | 253 171 AB | 73 59 3B | 273 187 BB | × | 113 75 4B | 313 203 CB | Ϸ | 133 91 5B | κ | 153 107 6B | 353 235 EB | ← | 173 123 7B | 373 251 FB |
| 1 1 0 0 | 12 | ┌ | 54 44 2C | 254 172 AC | 74 60 3C | 274 188 BC | Λ | 114 76 4C | 314 204 CC | η | 134 92 5C | λ | 154 108 6C | 354 236 EC | → | 174 124 7C | 374 252 FC |
| 1 1 0 1 | 13 | └ | 55 45 2D | 255 173 AD | 75 61 3D | 275 189 BD | ⇔ | 115 77 4D | 315 205 CD | U | 135 93 5D | | 155 109 6D | 355 237 ED | ↑ | 175 125 7D | 375 253 FD |
| 1 1 1 0 | 14 | ┌ | 56 46 2E | 256 174 AE | 76 62 3E | 276 190 BE | ⇒ | 116 78 4E | 316 206 CE | Λ | 136 94 5E | v | 156 110 6E | 356 238 EE | ↓ | 176 126 7E | 376 254 FE |
| 1 1 1 1 | 15 | └ | 57 47 2F | 257 175 AF | 77 63 3F | 277 191 BF | ≡ | 117 79 4F | 317 207 CF | ∇ | 137 95 5F | ∂ | 157 111 6F | 357 239 EF | | 177 127 7F | 377 255 FF |

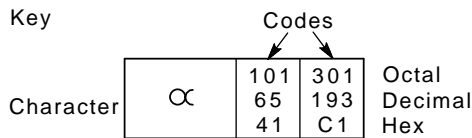

* Note: When Set is Mapped into GR Bit B8 is 1

GSF_0590_89A.DG

5 Using Character Sets

Selecting Graphic Character Sets

1. Designate the set as G0, G1, G2, or G3.
2. Map the designated set into the in-use table.

Designating Character Sets (SCS Sequences)

You designate a hard character set as G0 through G3 by using a select character set (SCS) escape sequence. You cannot designate a 96-character set as G0.

Format:

ESC $I_1 I_2 \dots I_n$ **F**

I_1 , *intermediate character*

Designates the character set as G0, G1, G2, or G3.

| I₁ Character | Code | Set Selection |
|--------------------------------|-------------|-----------------------------|
| 94-Character Sets | | |
| (left parenthesis | 2/8 | G0 (initial setting for GL) |
|) right parenthesis | 2/9 | G1 |
| * asterisk | 2/10 | G2 (initial setting for GR) |
| + plus sign | 2/11 | G3 |
| 96-Character Sets* | | |
| - hyphen | 2/13 | G1 |
| . period | 2/14 | G2 |
| / slash | 2/15 | G3 |

*You cannot designate a 96-character set into G0.

$I_2...I_n$ F, intermediate and final characters
 Selects one of the standard character sets.

| Character Set | $I_2...I_n$ F Characters | Code |
|--|-----------------------------|----------|
| 94-Character Sets | | |
| ASCII (initial G1 and G0 setting) | B | 4/2 |
| DEC Supplemental Graphic (initial G2 and G3 setting) | %5 | 2/5, 3/5 |
| Character Set | $I_2...I_n$ F Characters | Code |
| DEC Special Graphic | 0 | 3/0 |
| DEC Technical | > | 3/14 |
| User-preferred supplemental | < | 3/12 |
| NRC Sets* | | |
| ISO United Kingdom | A | 4/1 |
| DEC Finnish | 5 | 3/5 |
| ISO French | R | 5/2 |
| DEC French Canadian | 9 | 3/9 |
| ISO German | K | 4/11 |
| ISO Italian | Y | 5/9 |
| DEC Norwegian/Danish | 6 | 3/6 |
| ISO Norwegian/Danish | , | 6/0 |
| DEC Portuguese | %6 | 2/5, 3/6 |
| ISO Spanish | Z | 5/10 |
| DEC Swedish | 7 | 3/7 |
| DEC Swiss | = | 3/13 |

*Only one NRC set is available at a time. You must select national mode to use NRC sets. See "Character Set Mode (DECNRCM)" in the *VT320 Programmer Reference Manual*.

| Character Set | I ₂ ...I _n F Characters | Code |
|--------------------------|---|------|
| 96-Character Sets | | |
| ISO Latin-1 Supplemental | A | 4/1 |

If you set a font path and use double-height or double-width characters (ESC # 3, ESC # 4, ESC # 6) in a VTE window message, you may have to wait a few extra seconds for the terminal to load the larger fonts from the host the first time they are used. There is no delay if you use the terminal's local ROM fonts only.

11 VT1000 Reports

Sequences for VT1000 Reports

| Name | Mnemonic | Sequence |
|---|------------|-----------------------------------|
| Primary Device Attributes | | |
| Primary DA request (Host to VT1000) | DA | CSI c or CSI 0 c |
| Primary DA response (VT1000 to host) | DA | CSI ? Psc; Psl; ... Psn c |
| | <i>Psc</i> | = operating level. |
| | 61 | = level 1 (VT100 family). |
| | 62, 63 | = levels 2 and 3 (VT300 mode). |

| Name | Mnemonic | Sequence |
|------|----------|----------|
|------|----------|----------|

Primary Device Attributes

| | | |
|------------------|---|-------------------------|
| <i>Psl...Psn</i> | = | extensions. |
| 1 | = | 132 columns. |
| 2 | = | printer port. |
| 3 | = | ReGIS graphics. |
| 4 | = | sixel graphics. |
| 6 | = | selective erase. |
| 7 | = | soft character set. |
| 8 | = | user-defined keys. |
| 9 | = | NRC sets. |
| 11 | = | 25th status line. |
| 14 | = | 8-bit architecture. |
| 15 | = | DEC technical set. |
| 16 | = | ReGIS locator. |
| 17 | = | terminal state reports. |
| 29 | = | ANSI text locator. |
| 39 | = | page memory extension. |

See Table 10-1 for alias responses.

Secondary Device Attributes

| | | | |
|---|-----------|---|--|
| Secondary DA request (Host to VT1000) | DA | | CSI > c or CSI > 0 c |
| Secondary DA response (VT1000 to host) | DA | | CSI > Pp; Pv; Po c |
| | <i>Pp</i> | = | identification code. |
| | 42 | = | VT1000 terminal emulator. |
| | 28 | = | DECterm. |
| | 24 | = | VT320. |
| | Pv | = | firmware version. |
| | Po | = | hardware options. |
| | 0 | = | no options. |

Table 10–1 Primary DA Alias Responses from the VT1000

| Terminal | Identification Sequence | Meaning |
|-----------------|--|------------------|
| VT100 DA | ESC [? 1; 2 c | VT100 terminal |
| VT101 DA | ESC [? 1; 0 c | VT101 terminal |
| VT102 DA | ESC [? 6 c | VT102 terminal |
| VT220 DA | CSI ? 62; 1; 2; 6; 7; 8; 9 c | VT220 terminal |
| VT320 DA | CSI ? 63; 1; 2; 6; 7; 8; 9 c | VT320 terminal |
| VT1000 DA | CSI ? 63; 1; 2; 6; 8; 9; 15; 29 c | VT1000 terminal |
| DECterm DA | CSI ? 63; 1; 3; 4; 6; 7; 8; 9; 15; 16; 29 c | DECterm emulator |

NOTE

To change an alias response, you must use the Customize VTE General dialog box (Chapter 5).

Table 10–2 Control Function Requests (non-VT320)

| Control Function | Mnemonic | Intermediate and Final Character(s) |
|--------------------------|-----------------|--|
| Enable locator reports | DECELR | ' z |
| Enable filter rectangles | DECEFR | ' w |
| Select locator events | DECSLE | ' { |

Device Status Reports**VTE DSR—Keyboard Language**

The VTE Keyboard DSR control function (*CSI ? 27; Pd n*) reports the keyboard dialect chosen in the VT1000 Terminal Manager's Customize Keyboard dialog box, using the same *Pd* parameter values listed in the *VT320 Programmer Reference Manual*. Even if the keyboard map is loaded by the remote session manager, the terminal continues to report the locally customized value.

11

Solving Problems And Getting Service

This chapter describes some simple operating problems you can solve yourself. The chapter also includes sections on:

- The VT1000 power-up self-test
- Error messages
- How to get service

Operating Problems

Table 11-1 lists some possible operating problems and suggested solutions. If you have a problem with your terminal, check this list before calling for service. If the problem persists and you need service, see “Digital Service” in this chapter.

Table 11-1 Operating Problems

| Symptom | Possible Cause | Suggested Solution |
|----------------------------|---|--|
| System Box Problems | | |
| The system box fan is off. | The power cord is not plugged into the power outlet. | Make sure the power cord is plugged in and check and the power source. |
| | The system box's <input type="checkbox"/> /O power switch is off (O). | Turn the system box's power switch on (). |

Table 11–1 (Cont.) Operating Problems

| Symptom | Possible Cause | Suggested Solution |
|--|--|--|
| Monitor Problems | | |
| When you turn the terminal on, the monitor does not display the VT1000 Terminal Manager window after 45 seconds. | The monitor's <input type="checkbox"/> power switch is off (O). | Turn the monitor's power switch on (). |
| | The monitor cable is not connected to the system box. | Check the monitor cable connections. |
| | The monitor's brightness and contrast settings are too dark to see the screen display. | Adjust the monitor's brightness and contrast controls. See the monitor's installation guide. |
| | The keyboard cable is not connected. | Check the keyboard cable connections. |
| The screen is blank, but the terminal is on. | The monitor's fuse is blown. | Replace the fuse. |
| | The CRT saver feature may be on. | Check if the two keyboard lights are blinking, which may indicate the CRT saver is on. If the CRT saver is on, press any key to reactivate the screen. |
| The screen is distorted or the text font size is too small. | The monitor select switch is set to the wrong position. | Turn the monitor select switch setting on the back of the system box to the correct position (Chapter 2). Turn the system box's <input type="checkbox"/> power switch off (O) and then on (). |
| Customize Security Password Problems | | |
| You cannot display Customize dialog boxes that were locked. | The password for the Customize Security dialog box is lost. | Contact Digital Customer Services to perform a secure reset. |

Table 11–1 (Cont.) Operating Problems

| Symptom | Possible Cause | Suggested Solution |
|---|--|---|
| Mouse Problems | | |
| The pointer for the mouse or tablet does not appear on the screen, or the pointer does not respond to the pointing device commands. | The cable for the mouse or tablet is not connected securely to the system box. | Turn the system box's [I/O] power switch off (O), then disconnect and reconnect the mouse or tablet cable. Turn the system box's [I/O] power switch on (). |
| | The mouse is broken. | Replace the mouse. Until you get a new mouse, press [Ctrl] [F3] to use the editing keypad to perform mouse functions. See Chapter 8. |
| Keyboard Problems | | |
| The bell tone does not sound when you turn the VT1000 on. All keyboard indicator lights are off. | The keyboard cable is not connected. | Check the keyboard cable connection to the system box. |
| Keys do not work. | The [F1] (Hold) key is active. | Press the [F1] (Hold) key to release the screen. |
| Printer Problems | | |
| The printer does not print. | The printer's [I/O] power switch is off (O). | Turn the printer's power switch on (). |
| | The printer cable is not connected securely. | Check the printer cable connections. |

Table 11–1 (Cont.) Operating Problems**Printer Problems**

The communication settings on the terminal and printer do not match.

Make sure the communication settings (baud rate and parity) on the terminal and printer match. Choose the Printer Port... menu item from the VT1000 Terminal Manager's Customize Menu (Chapter 7.)

Network Problems

The host system and terminal do not communicate.

The ThinWire Ethernet cable is not connected securely to the system box.

Check the Ethernet cable and T-connector connections.

There is no T-connector between the connector on the ThinWire cable and the system box.

Check that there is a T-connector between the connector on the ThinWire cable and the system box.

There is a ThinWire segment between the system box and the T-connector.

Check that there is no ThinWire segment between the system box and the T-connector. (The T-connector must attach directly to the system box).

A T-connector with a terminator has been disconnected from an operating ThinWire Ethernet segment.

Check if a terminator has been removed or disconnected from an active ThinWire segment.

The system box port is inactive.

Make sure the port that your system cable is connected to is active.

Power-Up Self-Test

Every time you turn the terminal on, the VT1000 automatically runs a power-up self-test. This test checks the operating status of many internal parts in the terminal. During the test, the keyboard lights turn on and off. The power-up self-test should not take more than 45 seconds to complete.

If the test is successful, the bell tone sounds and the terminal displays the VT1000 Terminal Manager window.

If there were any test errors:

- A diagnostic message appears.
- The keyboard lights flash.
- The keyboard bell does not sound.

Screen Error Messages

If the VT1000 fails the power-up self-test, the terminal may display one of the error messages shown. Only qualified service personnel should try to correct these problems. You should note any error message that appears and call Digital Customer Services.

Internal error or CPU error - 11
External ROM error - 12
External RAM error - 13
NVR error - 14
Host port error - 15
Printer port error - 16
DUART1 timer error - 17
Keyboard port error - 18
Mouse port error - 19
DUART2 timer error - 21
Video RAM error - 22
Ethernet ROM error - 23
Ethernet port error - 24
Video error - 25
Mouse error - 26
Keyboard error - 27
Trap interrupt error - 28
Video control register error - 29
I/O data path error - 31
Illegal monitor error - 32
LANCER not reset on power up - 33
Image board error - 34

Digital Service

Digital provides a wide range of maintenance programs that cover small systems and terminals. These include on-site, carry-in, and mail-in maintenance services. You can use these programs to select the plan that suits your service needs.

Digital provides on-site repair and off-site repair services.

On-Site Hardware Services

Digital offers fast, low-cost, quality maintenance performed at your site by Digital-trained Service Specialists. There are several on-site services available.

DECservice

DECservice provides preferred on-site service, with a guaranteed response time when equipment is located within a specified distance of the service facility. DECservice guarantees a continuous repair effort until service is restored. You can choose the hours of coverage, up to 24 hours a day, 7 days a week.

Basic

Basic offers priority response during regular business hours, Monday through Friday.

Site SERVICenter

If you have a least 50 terminals and can provide workspace at your site, Digital will provide an on-site technician for a predetermined, periodic time interval. The terminals may include a variety of models (for example, VT200s and VT300s.)

Per Call

This noncontractual offering provides on-site repair based on time and materials. Per call service is available during regular business hours, Monday through Friday.

DECall

DECall is similar to per call service, but has an annual retainer fee. DECall gives you on-site service at a fixed fee per repair call.

Off-Site Hardware Services

Digital also provides several options for off-site service.

Carry-in SERVICenter

Digital SERVICenters are located in major cities around the world. They offer convenient, cost-effective repair service with a 48 hour turnaround time. Both contract and per call coverage is offered.

DECmailer

This is a mail-in service for module and subassembly repairs. DECmailer provides five day turnaround.

Software Services

DECsupport

This program provides telephone and on-site remedial support (if required), with personalized account focus and scheduled preventive maintenance. Software updates, new releases, and access to Digital's Software Information Network (DSIN) are included where available.

Basic

Basic service includes telephone support, software updates, new releases, and access to DSIN where available.

Self-Maintenance Service

This service provides software updates and new releases.

How To Get Service

Digital has a central service center in your area to help you keep your system running at peak efficiency. To find out more about Digital's hardware and software service offerings

In the United States

Call 1-800-554-3333 during regular business hours.

Outside the United States

Contact your local Digital Customer Services Office.

A

Specifications

This appendix lists the specifications for the VT1000 video terminal.

Site Planning

| | Weight | Height | Width | Depth |
|-----------------------|--------------------------------------|-------------------------------------|---------------------------------------|----------------------|
| System box | 5.4 kg (12 lb) | 60mm (2.38 in.) | 394 mm (15.5 in.) | 368 mm (14.5 in.) |
| VR150 monitor | 16.34 kg (36 lb) | 394 mm (15.5 in.) | 403 mm (15.9 in.) | 368 mm (14.5 in.) |
| VR262 monitor | 18 kg (40 lb) | 394 mm (15.5 in.) | 455 mm (17.9 in.) | 391 mm (15.4 in.) |
| VR315 monitor | 13 kg (29 lb) | 400 mm (15.7 in.) | 400 mm (15.7 in.) | 395 mm (15.4 in.) |
| VR319 monitor | 27.2 kg (60 lb) | 457 mm (18 in.) | 495 mm (19.5 in.) | 452 mm (17.8 in.) |
| VRE01 monitor | 7.7 kg (15 lb) | 390 mm (15.3 in.) | 427 mm (16.8 in.) | 70 mm (2.75 in.) |
| LK401 keyboard | 1.4 kg (3.1 lb) | 45 mm (1.75 in.) | 478 mm (18.8 in.) | 191 mm (7.5 in.) |
| Mouse | Weight 0.17 kg (0.4 lb) | Height 41 mm (1.6 in.) | Diameter 89 mm (3.5 in.) | |

Environment

| | Operating | Storage |
|-------------------|---------------------------------|-----------------------------------|
| Temperature | 10° to 40° C (50° to 104° F) | -40° to 66° C (-40° to 151° F) |
| Relative humidity | 10% to 90% | 0% to 95% |
| Maximum wet bulb | 28° C (82° F) | |
| Minimum dew point | 2° C (36° F) | |
| Maximum altitude | 2.4 km (8000 ft) | 9.1 km (30,000 ft) |

Electrical

| | |
|-----------------------|---|
| Line voltage (U.S.) | 100 to 120 Vac nominal 88 to 132 Vrms operating range single-phase, 3-wire |
| Line voltage (Europe) | 220 to 240 Vac nominal 176 to 264 Vrms operating range single phase, 3-wire |
| Line frequency | 50 to 60 Hz |
| Input power | 60 W maximum |
| Power cord | Detachable, 3-conductor, grounded |
| Power cord receptacle | EIA specified CEE22-6A |

Display (Monochrome Monitors)

| | |
|------------------|---|
| VR150 CRT | 381 mm (15 in.) |
| Resolution | 100 dots/in. |
| VR262 CRT | 482 mm (19 in.) |
| Resolution | 75 dots/in. |
| VR315 CRT | 380 mm (15 in.) |
| Resolution | 108 dots/in. |
| VR319 CRT | 485 mm (19 in.) |
| Resolution | 95 dots/in. |
| VRE01 flat panel | 482 mm (19 in.) electroluminescent screen |

LK401 Keyboard

General

| | |
|------------------|---|
| General | 108 sculptured keys with matte finish Available in 16 language dialects and 15 word processing versions, including English. Three French language keyboards. |
| Cord | 1.8 m (6 ft) coiled cord with a 4-pin telephone-type modular connector |
| Indicator lights | 2 keyboard indicators: <div style="display: flex; align-items: center; gap: 10px;"> <div style="border: 1px solid black; border-radius: 50%; width: 20px; height: 20px; display: flex; align-items: center; justify-content: center;">○</div> Hold </div> <div style="display: flex; align-items: center; gap: 10px; margin-top: 10px;"> <div style="border: 1px solid black; width: 20px; height: 20px; display: flex; align-items: center; justify-content: center;"> <div style="border: 1px solid black; width: 10px; height: 10px; margin: 0 auto;"></div> </div> Lock </div> |

Keys

(Approximate Size)

| | |
|-------------|---|
| Home row | 30 mm (1.18 in.) above desktop |
| Key size | 13 mm (0.50 in.) square |
| Key spacing | 19 mm (0.75 in.) center to center (for single-width keys) |

| Keys | (Approximate Size) |
|----------------|---|
| Numeric keypad | 18 keys |
| Function keys | 5 predefined keys, 15 user-definable keys |

| Audible Indicators | If enabled . . . |
|---------------------------|---|
| Keyclick | Sounds after each keystroke. |
| Margin bell | Rings once when cursor approaches right margin. |
| Warning bell | Rings for compose errors and system messages. |

TUV Rheinland Ergonomic Approval of VT1000 Video Terminal

The VT1000 Video Terminal with the VR262 monitor meets TUV Ergonomic requirements. Make sure your customize default settings are set to display the big font and light text on a dark background.

The ergonomic requirements for display work stations in the office sector referenced in ZH 1/618 are only upheld in negative polarity (light characters on dark background) and the big font.

Die ergonomischen Anforderungen an Bildschirmarbeitsplätze im Bürobereich nach ZH 1/618 sind nur bei negativer Zeichendarstellung (helle Zeichen auf dunklem Hintergrund) und großem Zeichensatz eingehalten.

B

Options and Documentation

You can order the following options, modems, cables, and manuals for the VT1000 video terminal from Digital. See the end of this appendix for ordering information.

Optional Memory Boards

| Option | Part Number | Description |
|-------------------------|--------------------|---|
| Memory controller board | VX10X-MA | Controller board for optional RAM memory (comes with a 1 megabyte SIMM card preinstalled) |
| SIMM card | VX10X-MD | 1 megabyte SIMM card |

Modems

| Part Number | Description |
|--------------------|--|
| DF224 Scholar Plus | 300, 1200, and 2400 baud, full-duplex asynchronous |
| DF224 | 300, 1200, and 2400 baud, full-duplex asynchronous |
| DF124 | 300, 600, and 1200 baud, full-duplex asynchronous |

Cables

| Part Number | Length | Connector |
|-----------------------------|--|-----------------|
| Communication Cables | | |
| BC16E-10 | 10 ft (3 m) | 6-pin M DEC-423 |
| BC16E-25 | 25 ft (7.6 m) | 6-pin M DEC-423 |
| AC Power Cables | | Country |
| BN20V-2E | Australia, New Zealand | |
| BN20S-2E | Austria, Belgium, Finland, France, Germany, Netherlands, Norway, Portugal, Spain, Sweden | |
| BN20P-2E | Canada | |
| BN20U-2E | Denmark | |
| BN20R-2E | Ireland, United Kingdom | |
| BN19U-2E | Israel | |
| BN20W-2E | Italy | |
| BN20T-2E | Switzerland | |

Related Documentation

You can order the following related documents from Digital:

| Document | Order Number |
|---------------------------------------|--------------|
| VMS DECwindows User's Guide | AA-MG18A-TE |
| ULTRIX Workstation (UWS) User's Guide | |
| VT1000 Service Guide | EK-V1000-PS |
| VT320 Programmer Reference Manual | EK-VT320-RM |
| VR150 Pocket Service Guide | EK-VR150-PS |
| VR262 Service Guide | EK-VR262-PS |
| VR315 Monitor Service Guide | EK-VR315-SG |
| VR319 Monitor Service Guide | EK-VR319-SG |
| VRE01 Service Guide | EK-VRE01-SG |

Ordering Information

You can order modems, supplies, and documentation by phone or by mail.

Continental USA and Puerto Rico

Call 800-258-1710 or mail to:

Digital Equipment Corporation
P.O. Box CS2008
Nashua, NH 03061

New Hampshire, Alaska, and Hawaii

Call 1-603-884-6660.

Outside the USA and Puerto Rico

Mail to:

Digital Equipment Corporation
Attn: Accessories and Supplies Business Manager
c/o Local Subsidiary or Digital-Approved Distributor

C

Communication

This appendix provides information on how the VT1000 communicates with a host computer, printer, or modem. The appendix describes

- Network communication protocols for LAT and TCP/IP connections
- Serial communication for text terminal windows, printers, and modems
- Signals carried by the serial communication and pointing device connectors on the back of the terminal.

The serial communication section shows the cables you can use for different system configurations.

Network Protocols

The VT1000 can use two network communication protocols, local area transport (LAT) and transmission control program/Internet protocol (TCP/IP). Each protocol connects the VT1000 to a host system through an Ethernet network.

LAT Functions

The LAT protocol connects the VT1000 terminal to VMS or ULTRIX hosts in a local area network. The LAT protocol is Digital's own local area network protocol. The VT1000 complies with the architecture for LAT Version 5.1 with extensions to define the characteristics of service classes 3 and 4.

The VT1000 supports LAT service classes 1, 3, and 4.

- **Service class 1** lets the VT1000 run video terminal window (VTE) applications through the LAT on VMS and ULTRIX systems.
- **Service class 3** lets the VT1000 run X window and DECwindows applications through the LAT on VMS systems.

- **Service class 4** lets the VT1000 access font files through the LAT on VMS systems.

TCP/IP Functions

The TCP/IP protocol connects the VT1000 terminal to ULTRIX or UNIX hosts in a wide-area network. TCP/IP is an Internet wide-area protocol.

The VT1000 provides the following TCP/IP functions:

- Internet protocol (IP)
- Transmission control program (TCP)
- User datagram protocol (UDP)
- Boot protocol (BOOTP)
- Internet control message protocol (ICMP)
- Trivial file transfer protocol (TFTP)
- Virtual terminal connection service (TELNET)
- An Internet demon to accept in-bound X connection requests.

Serial Communication

You can connect the VT1000 to a host or terminal server with a DEC-423 6-pin cable. The terminal has two serial communication ports, DEC-423 6-pin host port and a DEC-423 6-pin printer port. You can also use the printer port as a second host port, by changing settings in the Customize Printer Port dialog box (Chapter 7).

The terminal operates on full-duplex asynchronous lines only, with 10 possible transmit and receive speeds. You can use split transmit and receive speeds, but you must use the same speeds as your host system and printer. To match the speed of your host system or local printer, use the Customize Host Port or Customize Printer Port dialog box (Chapter 7).

Serial Communication Cables

You can connect the VT1000 directly to a local host system with a cable. You can also connect the terminal indirectly to a remote host system, using (1) a terminal server, or (2) a modem or acoustic coupler connected to public-switched or dedicated telephone lines.

You can connect the VT1000 to an asynchronous serial printer by using a null modem cable.

To order cables for connecting the VT1000 to a host system or printer, see Appendix B.

Serial XON/XOFF Flow Control

The VT1000 stores incoming characters in a character input buffer. The buffer can hold 254 characters. The terminal processes characters from the buffer on a first-in/first-out basis.

When the input buffer fills to 64 or 128 characters, the terminal sends an XOFF character to stop the host system from sending more characters. The default setting is 64. You can select from three settings—64, 128, or no XOFF—using the Customize Host Port or Customize Printer Port dialog box (Chapter 7).

NOTE

If you select No XOFF, the terminal does not send an XOFF character to the host system when the input buffer fills. Selecting No XOFF also disables the **F1 (Hold) key. With XOFF disabled, there is no way to ensure that data will not be lost.**

If the host system fails to respond to the XOFF character, the terminal sends a second XOFF character when the input buffer fills to 220 characters. The terminal sends a third XOFF character when the buffer is full.

When the input buffer falls below 32 characters, the terminal sends an XON character to tell the host system to start sending characters again.

If you enable XON/XOFF, the terminal recognizes received XON and XOFF characters. When the terminal receives XOFF, it stops sending data (except XON/XOFF characters). If the keyboard data buffer overflows, the keyboard locks. The terminal resumes transmission when it receives an XON.

Modems

A modem lets the VT1000 communicate over a telephone line with a remote computer system. The modem converts the serial characters sent between the terminal and computer into signals that can travel over telephone lines. The modem you use with your terminal must be compatible with the modem used by the host system.

You can use a variety of modems with your VT1000, such as Digital's DF224 modem. You can also use compatible modems, such as the AT&T 103, 113, and 212 types. See Appendix B for information on ordering modems.

The VT1000 must be certified for connection to non-AT&T type modems used outside of continental North America. Your local Digital Customer Services office has information on terminal certification and use of non-AT&T type modems.

To connect an approved modem to the VT1000:

1. Connect the modem cable to the 6-pin, DEC-423 host port on the rear of the terminal.
2. Display the Customize Host Port dialog box (Chapter 7).
3. Set the transmit and receive speeds to match your modem's speeds.

Modem Connections and Disconnections

When the VT1000 makes a connection to a host system through a modem, the terminal performs the following operations to ensure it is ready to send and receive:

- Unlocks the keyboard (if it was locked).
- Clears any transmission in progress.
- Clears the keyboard buffer and all message buffers.
- Clears the input buffer.
- Clears XOFF sent and XOFF received.

Any of the following conditions will disconnect the connection to the host system:

- You type **[Shift] [F5]** (Break).
- You choose the Use Last Saved Settings or Use System Defaults menu items from the Customize menu.

- The terminal loses the data set ready (DSR) signal.
- The terminal receives a self-test command from the host system.

The usual way to disconnect communications is to type **[Shift] [F5]** (Break). The host system's response to the disconnect signal depends on the system and the software.

Break Function

A break condition is the occurrence of a continuous space on a communication line for greater than one character time. If you are using a modem on a VMS operating system, this condition causes the modem to disconnect the terminal from the host system.

The **[F5]** (Break) key has three functions.

- If enabled, pressing **[F5]** (Break) sends a break signal to the host. If disabled, you can still send a break signal to the host by typing **[Shift] [F5]** (Break).
- Pressing **[Shift] [F5]** (Break) disconnects communications when you use a modem.
- Pressing **[Ctrl] [F5]** (Break) sends the answerback message to the host. You enter the message by using the Customize VTE General dialog box (Chapter 5).

Communication Connector Signals

The terminal has one DEC-423 host system (communication) connector and one DEC-423 printer connector on the rear of the terminal. Table C-1 describes the signals for both 6-pin connectors. The following figure shows the pin numbers for the 6-pin connectors:

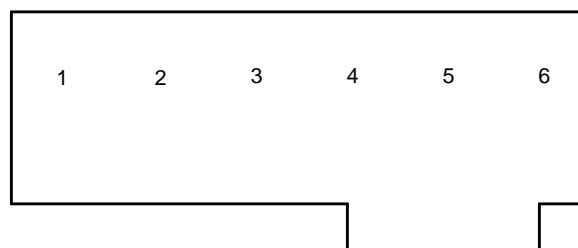

GSF_1383_89.DG

Table C-1 6-Pin DEC-423 Communication and Printer Interface Signals

| Pin | Signal | Mnemonic | Description |
|------------|------------------------|-----------------|--|
| 1 | Data terminal ready | DTR | <i>From VT1000</i> When on, tells the modem or printer that the VT1000 is ready to send or receive. |
| 2 | Transmit data | TXD+ | <i>From VT1000</i> Sends serial characters. Held in the mark state (-) when characters are not being sent. In modem control modes, sends data only when DSR and DTR signals are on. |
| 3 | Transmit signal ground | TXD- | Provides the common ground reference potential for transmitted signals TXD+ and DTR. |
| 4 | Receive signal ground | RXD- | Provides the common ground reference potential for received signals RXD+ and DSR. |
| 5 | Receive data | RXD+ | <i>To VT1000</i> Receives serial characters. |
| 6 | Data set ready | DSR | <i>To VT1000</i> From the modem: When on, tells the VT1000 that it has a call connected. From the printer: When on, tells the VT1000 that the printer is ready to print. If DSR is present at power-up, the printer controls print operations. If DSR is not present at power-up, the terminal checks for DSR before each print operation. |

Pin Signals for the Pointing Device Connector

The terminal uses a 7-pin micro DIN connector for the pointing device. Table C-2 lists the connector pin assignments.

Table C-2 Pin Assignments for the Pointing Device Connector

| Pin | Signal | Mnemonic |
|------------|-------------------|-----------------|
| 1 | Protective ground | GND |
| 2 | Transmit data | TXD |
| 3 | Receive data | RXD |
| 4 | — | GND/-12 |
| 5 | — | +5 |
| 6 | Not used | — |
| 7 | Not used | — |

Standards

The VT1000 operates in accordance with the following national and international communication standards:

| | |
|------------|------------|
| EIA 232-D | CCITT V.10 |
| CCITT V.24 | ISO 2110.2 |
| CCITT V.28 | |

D

System Management Tasks

This appendix describes certain tasks a system manager must perform in the LAT and TCP/IP environments to prepare the system to support X applications on VT1000 terminals. The appendix also describes how to run a remote X window session on a VMS host that is not in your local area (LAT) network.

The appendix is divided into three sections:

- LAT environment (VMS systems)
- TCP/IP environment (ULTRIX and UNIX systems)
- Running a remote X window session on a VMS system

Preparing the LAT Environment (VMS Systems)

Perform the following steps to prepare your LAT environment to support VT1000 terminals:

- Your system startup procedures will start the LAT driver, using the procedure LTLOAD.COM.
- Do *not* call DECW\$STARTUP from your SYSTARTUP_V5.COM command file. Under VMS Version 5.2 or higher, DECW\$STARTUP is called from one of the system command files and not from your system-specific SYSTARTUP_V5.COM.
- To start DECwindows terminal support, you must include the following logical in your system startup procedures before starting DECnet:

```
$ DEFINE/SYSTEM DECW$INSTALL_XTERMINAL TRUE
```

After the next reboot, your system will be ready to support the VT1000 terminal.

If you do *not* want to start DECwindows terminal support on a particular node, you may add the following to a root-specific startup file:

```
$ DEFINE/SYSTEM DECW$INSTALL_XTERMINAL FALSE
```

LAT Font Path

By default, the VMS font daemon expands the nodename given in the font path to `<nodename>::DECW$XTERMINAL_FONT`. This logical is a searchlist that points to several subdirectories. To use another font library for custom applications instead of the DECWindows fonts, use the full directory specification in the font path field of the terminal.

Preparing the TCP/IP Environment (ULTRIX and UNIX Systems)

Perform the following steps to prepare your TCP/IP environment to support VT1000 terminals. These steps require Superuser privilege.

For Telnet VTE:

1. Edit `/etc/inetd.conf` to enable `telnet`.
2. Assign a network-wide IP address to the terminal.
3. Optional: Add the IP address to the network address table `/usr/etc/bootptab` and edit `/etc/inetd.conf` to enable `bootp` (if available). (Allows terminal to automatically determine its IP address at power-up.)

For X applications:

- Perform the steps above, plus:
4. Edit `/etc/inetd.conf` to enable `tftp`.
 5. Create font file directory structures.
 6. Create a font directory file pointing to the fonts for your terminal's resolution (75 dots/inch or 100 dots/inch).
 7. Enter the font path in the Customize Fonts window in the terminal.

1. Edit /etc/inetd.conf to enable telnet.

Edit the Internet daemon configuration file `/etc/inetd.conf`. The following example is taken from the sample file that ULTRIX provides, with most lines commented out. (This sample lists only the three lines that are discussed in this chapter. Refer to it for bootp and tftp as well as telnet.)

The line starting with telnet should be uncommented (delete the leading # character) and completed, to enable VTE windows in the TCP/IP environment. Telnet is the network terminal protocol daemon (network listener program).

```
# /etc/inetd.conf (Internet daemon configuration file):
#
# @(#)inetd.conf      4.1.1.4      (ULTRIX)      4/19/88
# Internet server configuration database
#
telnet  stream  tcp      nowait  /etc/telnetd  telnetd
tftp   dgram    udp      nowait  /usr/etc/tftpd  tftpd -r /tftpboot
bootp  dgram    udp      wait    /usr/etc/bootpd  bootpd -i
```

To make the `/etc/inetd` daemon read the edited file, use the following command to get the processor status for `inetd`.

```
ps -lax | grep inetd
```

This command produces a display similar to this example:

```
      F UID  PID PPID CP  PRI  NI  ADDR  SZ  RSS  WCHAN  STAT  TT  TIME  COMMAND
3000001  0  150   1  0   1  0 303c  62  40  c10e8  I   ?  0:26  /etc/inetd
b000001 268 3391 3383  0   1  0 4808  14   6  17518  S   p2 0:00  grep inetd
```

The second line tells you the process ID number (PID) of the `inetd` daemon, which is 150 for this example.

The next command makes `/etc/inetd` restart and read the `/etc/inetd.conf` file to activate the edits made in the file.

```
kill -1 150
```

2. Assign an IP address.

Pick a unique number in your network address group. Enter the address and a subnet mask value, using the terminal's Customize TCP/IP dialog box. Or, complete the next optional step and then click on the Determine IP Address button in the Customize TCP/IP dialog box.

3. Update the network address table for the system.

If you have `bootp` available, individual users can have the VT1000 request an IP address automatically at power-up, or by clicking on the Determine IP Address button in the Customize TCP/IP dialog box. A supporting host must be able to resolve the IP address from the hardwired Ethernet address in the terminal.

NOTE

If `bootp` is enabled but a user does not want automatic start-up of TCP/IP in the terminal at power-up, enter and save address 0.0.0.0 in the Customize TCP/IP dialog box.

You need to edit the BOOTP table file for automatic IP address resolution. If the file does not already exist, create it with the name `/usr/etc/bootptab`. This file lists each VT1000 IP address in the following format:

name 1 Ethernet_address IP_address default_file

| | |
|-------------------------------|--|
| <code>name</code> | Is the name used in the <code>/etc/hosts</code> file. |
| <code>1</code> | Signifies the base network as Ethernet. |
| <code>Ethernet_address</code> | Is the terminal's Ethernet address in hexadecimal format: <code>xx.xx.xx.xx.xx.xx</code> . The Ethernet address appears in the VT1000 Terminal Manager window. |
| <code>IP_address</code> | Is the terminal's IP address used in the file <code>/etc/hosts</code> . This address can use any valid IP address format. |
| <code>default_file</code> | Not used. |

Example of a `/usr/etc/bootptab` file

```
#
# home directory
/
%%
# host htype haddr iaddr bootfile
Aleph      1 aa:00:04:00:38:de 123.45.67.81
Bet        1 08:00:ab:11:4d:28 123.45.67.82
Gimel     1 08:00:01:23:d2:b3 123.45.67.83
Dalet     1 50:12:34:56:24:74 123.45.67.84
```

4. Edit /etc/inetd.conf to enable tftp.

Edit the Internet daemon configuration file `/etc/inetd.conf`.

TFTP (trivial file transfer program) is the program that transfers font data from the font files to the terminal. Because network access to the directories where the fonts reside can have consequences for system security, there are at least two kinds of access privilege available. The flexibility of the network software allows many ways to implement each kind of access privilege, depending on the preferred operating environment.

For unrestricted access, edit the following line in your `inetd.conf` file:

```
tftp dgram udp nowait /usr/etc/tftpd tftpd
```

For Restricted access, edit the following line in your `inetd.conf` file:

```
tftp dgram udp nowait /usr/etc/tftpd tftpd -r /tftpboot
```

This enables TFTP, the transfer protocol that allows the VT1000 to read the font file. The `-r` switch sets security on the system so only files located below the specified directory can be accessed from the network.

See step 1 for instructions to restart `/etc/inetd` to activate the changes you made.

5. Create a font file directory structure.

ULTRIX workstation software ships with TFTP network access restricted to a temporary directory that is normally empty. You can modify this restriction to allow access only to the directory containing the font files. However, there may be other applications and devices running on the network that need access to other directories.

One example is the LPS20 and LPS40 series of laser printers that require access to a supporting host to provide downloaded software. The LPS supporting host software installation creates its own directory and sets up TFTP to provide network access only to its directory. See “Revising the LPS Supporting Host” at the end of this section for the commands to link the LPS directory to the new directory structure.

To allow access only to those files that are specifically intended for the network but are in separate directories, Digital recommends that you create a generic network access directory (for example `/tftpboot`) and then add links to the authorized directories and files. This lets you avoid moving files around, using extra disk space, or otherwise changing the existing product installation procedures.

NOTE

You may have to re-edit the `/etc/inetd.conf` file after installing LPS supporting host software, because that installation procedure changes the TFTP setup to be restricted to `/usr/lib`.

The following diagram shows the directory and link structure for UWS version 2.2 that allows network access to all needed files. This structure may be expanded to accommodate other products. The link (...>) from `/tftpboot` to `/usr/tftpboot` is symbolic. The links between the `tftpboot/*.pcf` files and the `lib/*.pcf` files and between the similar sets of `*.sys` files are hard.

UWS Version 2.2 Directory Structure

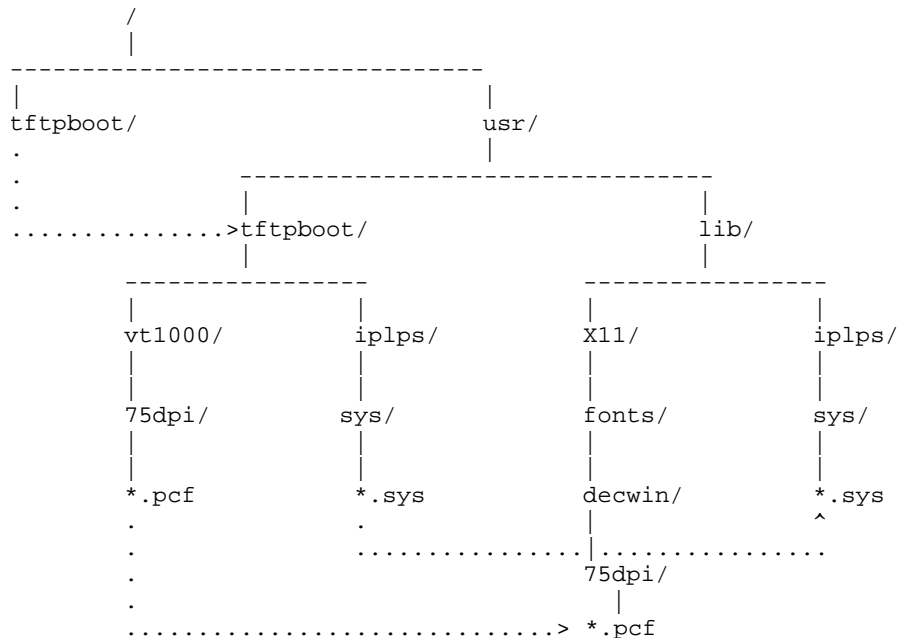

Creating a Directory Structure

To create the directory, issue the following commands on the host. (The instructions are different for UWS Version 2.1 and Version 2.2, because the locations and file types of the font files changed between versions.)

For UWS Version 2.1

```
$ cd /
$ mkdir /usr/tftpboot
$ ln -s /usr/tftpboot /tftpboot
$ cd /tftpboot
$ mkdir vt1000
$ cd /usr/lib/dfw
$ find 75dpi 100dpi -print | cpio -pvd1 /tftpboot/vt1000
```

For UWS Version 2.2

```
$ cd /
$ mkdir /usr/tftpboot
$ ln -s /usr/tftpboot /tftpboot
$ cd /tftpboot
$ mkdir vt1000
$ cd /usr/lib/X11/fonts/decwin
$ find 75dpi 100dpi -print | cpio -pvd1 /tftpboot/vt1000
```

6. Create a font path definition file.

After the links to the font files have been created, font directory files need to be created.

To set an ULTRIX font path, the terminal looks for a font path file on the font server host at the location specified in the Customize Font Path dialog box. The terminal uses the contents of the font path file as a guide to the available fonts.

The terminal accesses fonts using TFTP. Users need to specify a font path. You need to create a file that specifies the location of each available font. This file must have world read access.

To create a font path file for VT1000 firmware Version 2.0 or higher, issue the following commands on the host. (See the following instructions for Firmware Version 1.1 or higher.)

For UWS Version 2.1

Change directory to /tftpboot, and list the 75 dpi font file names into vt1000/75dpi/fonts.dir and the 100 dpi font file names into vt1000/100dpi/fonts.dir.

```
$ cd /tftpboot
$ find vt1000/75dpi -name "*.dwf" -print > vt1000/75dpi/fonts.dir
$ find vt1000/100dpi -name "*.dwf" -print > vt1000/100dpi/fonts.dir
```

For UWS Version 2.2

Change directory to /tftpboot/vt1000/75dpi, create a font directory file, and then do the same for 100dpi.

```
$ cd /tftpboot/vt1000/75dpi
$ dxmkfontdir
$ cd /tftpboot/vt1000/100dpi
$ dxmkfontdir
```

7. Enter a font path in the terminal.

Use one of the following font paths on your terminal:

For the VR262 or VRE01 monitors, use the 75 dots/inch fonts.

Unrestricted:

```
ROM,123.45.67.89:/tftpboot/vt1000/75dpi/fonts.dir
```

Restricted:

```
ROM,123.45.67.89:/vt1000/75dpi/fonts.dir
```

For the VR150, VR315, or VR319 monitors, use the 100 dot per inch fonts.

Unrestricted:

```
ROM,123.45.67.89:/tftpboot/vt1000/100dpi/fonts.dir
```

Restricted:

```
ROM,123.45.67.89:/vt1000/100dpi/fonts.dir
```

NOTE

Specifying the TFTP font path in this way lets the terminal set the font path in the least amount of time. If you only need to use one size of fonts, Digital recommends this method.

**For Firmware Version 1.1 or Higher,
or When Using More Than One Font Directory at a Time**

Use this procedure to provide support for:

- VT1000 Firmware Version 1.1 or higher.
- Simultaneous access to more than one font directory at a time.

You must create a `font.paths` file to direct the terminal to the multiple directories.

For UWS Version 2.1

- Change the directory to `/tftpboot/vt1000`.
- Move all the lines in the two `fonts.dir` files into the `font.paths` file.

```
$ cd /tftpboot/vt1000
$ cat 75dpi/fonts.dir 100dpi/fonts.dir > font.paths
```

For UWS Version 2.2

- Change the directory to `/tftpboot/vt1000`.
- Switch to the Bourne shell for the `for` command, if not already there.
- For both the `75dpi` and `100dpi` directories, copy only the lines that contain font file names from the `font.dir` files and insert the directory path in front of the font file name.
- Put the names in the `font.paths` file.

```
$ cd /tftpboot/vt1000
$ /bin/sh
$ for i in 75dpi 100dpi
> do
> grep -v '^[0-9]*$' $i/fonts.dir | sed "s?^?$i/?"
> done > font.paths
```

To access both the 75dpi and 100dpi fonts

Use the following font path on the terminal:

Unrestricted:

```
ROM,123.45.67.89:/tftpboot/vt1000/font.paths
```

Restricted:

```
ROM,123.45.67.89:/vt1000/font.paths
```

Revising the LPS Supporting Host

Use the following commands to set up the directory links to allow network access to the supporting host software:

```
$ cd /tftpboot
$ mkdir iplps
$ cd /usr/lib/iplps
$ find sys -print | cpio -pvdl /tftpboot/iplps
```

The path to the LPS supporting host code remains the same as before:

```
12.34.56.789:/iplps/sys/*.sys
```

Font Server Requirement for UWS Version 2.2 RISC

You cannot use a DECstation 2100 or DECstation 3100 (RISC) machine running software prior to UWS Version 2.2 as a font server. The fonts native to the earlier UWS system will not work with the VT1000, and the attempt to set a font path will fail with no error message. An ULTRIX-32 system running UWS Version 2.1 or higher, or a VAX VMS system running Version 5.3-1 or higher may be used as a font server for your terminal if it is on the same Ethernet network.

Running a Remote X Window Session on a VMS System

This section describes how to use your VT1000 terminal to open an X window session on one of the following:

- A host that is not in your local area (LAT) network
- A host running VMS Version 5.0–5.3

You must use DECnet to route the session through a host on your local area network that supports the VT1000 (called LOCAL in this example). Using a few VMS DCL commands, you can run an X window application or DECwindows session on a remote host (called REMOTE in this example).

The XTerminal driver allows connections to a DECwindows terminal over DECnet by assigning a DECnet server number for the DECwindows terminal on the supporting host. Without this, access to the DECwindows terminal is limited to hosts running the DECwindows terminal support package on the same Ethernet.

To use the DECnet Access Option, you must run DECW\$DWT_DECNET with DECW\$DISPLAY defined as the DECwindows terminal. DECW\$DISPLAY is defined for you if you are already running a DECwindows session, or you can define it with the SET DISPLAY/CREATE command. Use the 12 characters of the LAT host name in your VT1000 terminal for the node value in the example command:

```
$ SET DISPLAY/CREATE/NODE=LAT_XXXXXXXXXXXX/TRANSPORT=LAT
```

Normally, DECW\$DWT_DECNET chooses a server number for you. However, in this release, you must define a server number. The number is arbitrary but cannot conflict with server numbers of other users of DECW\$DWT_DECNET on your system. Each user should use a different number. Ask your system manager to assign a number to you. Then put the following line, with the assigned server number (100 in this example), in your LOGIN.COM file on node LOCAL.

```
$ DEFINE DECW$DWT_DECNET_SERVER 100
```

To use the remote connection, you must provide a list on node LOCAL of authorized remote accounts that can use the DECnet Access Option to access your terminal. Without this list, the terminal refuses all remote connections. Creating the list is a one-time activity, but you can update it at any time to allow additional connections.

The list is in a file in DECW\$USER_DEFAULTS: (normally SYSS\$LOGIN:) called DECW\$DWT_DECNET_AUTHORIZE.DAT. In this text file, each line has three entries:

| | <transport> | <remote node> | <user> |
|--------------|-------------|---------------|--------|
| For example: | DECNET | REMOTE | USER1 |

Each line authorizes a single user to access the DECwindows terminal through the DECnet Access Option. There is no limit to the number of lines in the file.

The transport should be only DECnet.

```
$ CREATE DECW$USER_DEFAULTS:DECW$DWT_DECNET_AUTHORIZE.DAT
DECNET REMOTE USER1
^Z
```

You can execute the command interactively to start the DECnet Access Option, or you can put the following command in your DECW\$LOGIN.COM (executed when the DECwindows Session Manager is started). The server number is announced on SYSS\$OUTPUT when DECW\$DWT_DECNET is started.

```
$ SPAWN/NOWAIT/INPUT=NL: RUN SYSS$SYSTEM:DECW$DWT_DECNET
```

The system replies with a message:

```
[Assigned DECnet server number 100 on node LOCAL]
[Remote display is server number 0 on
node LAT_XXXXXXXXXXXX using LAT transport]
```

You may press to get a system prompt, then you can log into the remote host. Execute the following command to establish a connection between the DECnet servers on the supporting host and the remote host. The server number should be the predefined value from the earlier step on the supporting host.

```
$ SET DISPLAY/CREATE/NODE=REMOTE/SERVER=100/TRANSPORT=DECNET
```

You can now start an X application on the remote host, and the application will be displayed on your VT1000.

Glossary

ANSI

American National Standards Institute

ASCII

American Standard Code for Information Interchange. A set of 7- or 8-bit binary numbers representing the alphabet, punctuation, numerals, and other special symbols used in text representation and communications protocol.

Application

A program that performs a specific task.

CCITT

Comite Consultatif International de Telegraphique et Telephonique (International Telegraph and Telephone Consultative Committee). A standards committee for the communication industry in Europe.

Character set

A group of graphic characters and control characters stored as a unit in the terminal. Graphic characters are characters you can display on the screen. Control characters perform special functions.

Compose character

A character produced by pressing two or three keys in sequence, starting with the key or a diacritical mark key. You can use compose sequences to produce characters that do not appear as standard keys on your keyboard.

Computer system

A combination of system hardware, software, and external devices that performs operations and tasks.

Cursor

A blinking line or block on the screen that indicates the active position.

DEC Multinational character set

The default character set for the VT1000 terminal. The DEC Multinational set is one of two 8-bit sets built into the VT1000. The other set is ISO Latin-1. Both 8-bit sets include the standard ASCII character set and a supplemental set. For 7-bit environments, see *National replacement character sets*.

Data processing keys

Keys that have three or four characters on the top of their keycap. The characters on the right half of the keycap are data processing characters. To use data processing characters, you must choose the data processing version of your keyboard in the Customize Keyboard dialog box.

DECconnect

Digital's cabling system for extending Ethernet and terminal interconnections into offices and work areas.

DECnet

Digital's networking software that runs on nodes in both local and wide area networks.

Default option

A push button with a double outline, indicating the most frequently used setting for a window. You can choose a default option by pressing Return or clicking on the push button.

Default setting

A standard setting for one of the terminal's operating features, set at the factory. The VT1000 uses factory-default settings, unless you choose a new setting.

Device icon

An icon on the back of the system box that identifies the device that can be plugged into the connector.

Diacritical marks

Marks or symbols that indicate a change in the standard pronunciation of a letter. Examples of diacritics are acute accent (´), grave accent (`), and tilde (~). On the VT1000, you can use diacritical marks (if available on your keyboard) to start two-stroke compose sequences.

Ethernet

A type of local area network, based on Carrier Sense Multiple Access with Collision Detection (CSMA/CD). A communication concept for local communication networks that use coaxial cable.

Filter rectangle

A bounded area used defined on the screen. To activate the filter, you define its coordinates with a control function. If the terminal detects that the locator is outside the filter rectangle, the terminal sends an outside rectangle event and disables the rectangle.

Font path

A logical file that lets a device access alternate character fonts for certain X window applications.

Full-duplex modem

A *modem* that can handle simultaneous, two-way communications.

Graphics

The use of lines, figures, shapes, and shaded areas to display information.

Graphics tablet

An optional device used to move the graphics input cursor on the screen and to enter data to an application program. Most tablets have three parts: a tablet, stylus, and puck. To move the cursor you move the puck or stylus across the tablet. Also known as a *locator device*.

Group code

A number that represents a host or group of hosts on a *LAT* network.

Hardware

The physical equipment—mechanical and electrical—that make up a system. Compare to *Software*.

Hardware Ethernet address

The unique Ethernet physical address associated with a particular Ethernet communications controller.

Host system

A computer system that has an active connection to your terminal. The primary or controlling computer in a multiple-computer network.

Icon

A graphic representation of an object, application, process, or window.

Internet

A collection of networks that includes the ARPAnet, a number of local networks at universities and research institutions, and many military networks. See *TCP/IP*.

IP address

A unique network address that identifies a device on the TCP/IP network.

ISO

International Standards Organization. ISO Latin-1 is one of the two 8-bit multinational character sets built into the VT1000. The other set is the *DEC Multinational* set. For 7-bit environments, see *National replacement character sets*.

Kilobyte (KB)

When referring to memory, 1024 bytes.

LAT

Local area transport. A network protocol created by Digital for local area network communication.

LAT address

A network address that identifies the location of a device on the LAT network.

LED

Light-emitting diode. LEDs are used as indicators on the keyboard.

Local area network (LAN)

A high-speed communications network that covers a limited geographical area, such as a section of a building, an entire building, or a cluster of buildings.

Locator device

See *pointing device*.

Megabyte (MB)

When referring to memory, 1024 kilobytes or 1,048,576 bytes.

Modem

Modulator - demodulator. A device that converts data from a computer or terminal into signals that can be sent over a telephone line and back again.

Modifier key

A key pressed in combination with another key, to modify the code sent by that key. **Ctrl** is a modifier key.

Monochrome monitor

A video screen that displays images in shades of one color.

Mouse

A handheld pointing device used to select menu options and draw graphics. Moving the mouse across the desktop moves the pointer or mouse cursor on the screen. The mouse has three buttons that serve as function keys.

National replacement character sets (NRCs)

Seven-bit character sets for many Western European languages. Each set has 94 characters. NRC sets are similar to the ASCII set, except for a few characters.

Network

Two or more computers linked by communication lines to share information or resources.

Network coordinator

The person who manages the network, assigns unique node names and addresses for each VT1000 on the network, and provides administrative assistance to network users.

Node

A computer, workstation, or peripheral device that is connected to a network and can communicate with other members of the network.

Nonvolatile memory

Random access memory (RAM) that does not lose its contents when you turn the terminal off. The VT1000 uses this memory to store your saved customize settings.

Pixel

Picture elements. The smallest displayable unit on a video screen. To display a character, the terminal turns on a series of pixels.

Pointing device

A mouse or a graphics tablet, used with X window applications and menus to move the cursor on the screen. Also called a locator device.

Port

A means for connecting one device to another. Usually, each port has an associated connector.

Prefix key

A key that you press and release before pressing another key, to change the function of one or more keystrokes. `Compose Character` is a prefix key.

Random access memory (RAM)

Memory that can be read from and written to. The VT1000 uses this memory to store instructions of programs currently being run.

Read-only memory (ROM)

Memory that can be read from, but not modified. The VT1000 uses ROM memory to store its operating code.

ReGIS

A serial geometric graphics display protocol created by Digital.

Scroll bar

A vertical or horizontal bar that lets you scroll information in the associated window. The scroll bar includes *stepping arrows* and a *slider* that let you move at various rates.

Scrolling

Moving information on the screen upward or downward to display more data.

Server

Hardware or software that provides a specific set of services to a client.

Service

A name that represents a host or cluster of hosts that provides access to that host or cluster.

Session

An active connection between the terminal and the host system.

Sixel

A vertical column of six *pixels*. Screen displays can be printed in the form of sixel graphics.

Slider

Part of a *scroll bar* that lets you scroll through information in a window. The size of the slider indicates how much of a file is currently displayed. The smaller the slider, the larger the file. The location of the slider in the scroll region indicates your relative position in the file.

Software

Programs that perform a chosen or required function. Compare to *Hardware*.

Stepping arrow

Part of a scroll bar that lets you move incrementally through information in a window.

System

A combination of hardware, software, and peripheral devices that perform specific processing operations.

System manager

A person who performs tasks necessary to operate and maintain the system. See *Network coordinator*.

TCP/IP

Transmission control protocol/Internet protocol. The standard wide area networking software for the ULTRIX and UNIX operating systems. TCP/IP is a set of protocols developed by researchers centered around the Advanced Research Projects Administration Network (ARPAnet).

Terminal server

An intelligent unit that can connect a number of asynchronous devices (terminals and printers) to a host system. For example, Digital's DECserver 200 can link eight VT1000 terminals to a system in a local area network (LAN), using a high-speed Ethernet cable.

Terminator

A connector used on one or both ends of an Ethernet segment that provides the 50-ohm termination resistance needed for the cable.

ThinWire Ethernet network

A term to describe Digital's 10base2 (IEEE standard 802.3 compliant) Ethernet products used for local distribution of data.

Transition

The pressing or releasing of a locator button. The terminal can report transitions to the host system, using locator reports.

ULTRIX

A UNIX based operating system created by Digital.

UNIX

An operating system created by AT&T.

User-defined keys (UDKs)

Any of the 15 keys (**F6** through **F20**) on the top row of the keyboard a user can define to perform specific functions.

Visual character attribute

A quality of a display character that highlights the character, such as bolding and underlining.

VMS

Digital's proprietary operating system.

Window

An area on your monitor screen that represents all or part of an application.

Window system

A windowing architecture that allows the execution and display of applications to be independent. Specific components of the architecture control the display of applications and determine how applications run. Since its introduction by MIT, the X Window System has become an industry standard.

Index

<X>

function, 85

A

Accept Connections When Idle
button, 125

Additional characters, 160 to 169
canceling a sequence, 163
hexadecimal sequences, 164
invalid sequences, 163
table, 166

Alternate Shift key (German), 154

,< and .> keys, 85

Answerback message, 83
sending, 157

Appl Cursor Keys button, 81

Application Keypad button, 82

Applications

moving between, 55
running as icons, 57

Apply push button, 74, 113

Arrow keys, 155
function, 81

Audible indicators, 159

Authorizing hosts

LAT or TCP/IP connections, 123

Authorizing users, 122, 128

Auto print mode, 88
selecting, 156

Auto Repeat button, 85, 116

Auto Resize Terminal button, 76

Auto Wrap button, 78

B

<X> Backspace button, 85

Baud rate

serial communication, 136

Bell, 159

Bell volume, 115

Big font setting, 77

BIND name servers, 144

7-bit character sets, 176

8-Bit Multinational Characters
button, 81

7-Bit NRC Characters button, 81

Break function, 201

Break key

See **F5** key

£ key, 158

C

Cables

connections, 17

ordering, 195

Cancel push button, 74, 113

Character format

serial communication, 137

Character sets, 7, 177

7-bit, 176

DEC Technical, 176

for printers, 89

typing additional characters, 161

VTE window

7-bit NRC sets, 86

choosing a multinational set,
82

2 Index

- Character sets
 - VTE window (Cont.)
 - selecting 8-bit or 7-bit, 81
- Clear Communications menu item, 68
- Clear Display menu item, 68
- Clicking
 - defined, 53
- Communication, 197 to 203
 - See also* Serial communication
 - breaking, 201
 - breaking serial, 156
 - modems, 200
 - network problems, 186
 - network protocols, 197
 - pointing device
 - signals, 203
 - serial, 198
 - cables, 199
 - connector signals, 201
 - XON/XOFF flow control, 199
 - standards, 203
- Components, 1
 - Compose Character key, 154, 162
- Compose sequences, 162
- Composing characters
 - See* Additional characters
- Computer sessions
 - See* Sessions
- Conceal Answerback Message
 - button, 83
- Condensed font setting, 77
- Confirm Quit Session button, 133
- Connectors, 17
 - system, 12
- Copying text, 69
 - disabled by some applications, 72
 - host synchronization, 70
 - selecting text, 71
- Copy menu item, 70
- Create menu, 39, 45, 93
- Ctrl key, 153
- Cursor
 - blinking or steady, 79
- Cursor (Cont.)
 - style, 79
 - text, 79
- Customer service
 - See* Service
- Customize menu, 113
 - Terminal Manager window, 32, 34, 112 to 150
 - Customize Font Path dialog box, 38, 44, 147
 - Customize Host Port dialog box, 135, 136
 - Customize Keyboard dialog box, 34, 115
 - Customize Language dialog box, 33, 118
 - Customize LAT dialog box, 36, 138
 - Customize Pointer dialog box, 119
 - Customize Print Screen dialog box, 120
 - Customize Security dialog box, 122
 - Customize TCP/IP dialog box, 42, 142
 - Customize TCP/IP Name Server dialog box, 144
 - Customize TCP/IP Routing Tables dialog box, 145
 - Customize Terminal Manager dialog box, 132
 - Customize Window dialog box, 129
 - display language, 118
 - font path, 147
 - host or printer port settings, 134
 - keyboard settings, 115
 - LAT settings, 138
 - message displays, 132
 - pointer and mouse settings, 119
 - recalling settings, 114
 - saving settings, 114
 - security password, 128

Customize menu
 Terminal Manager window (Cont.)
 security settings, 122
 TCP/IP Name Server settings, 144
 TCP/IP routing table settings, 145
 TCP/IP settings, 142
 window settings, 129
 VTE window, 72
 VTE windows
 Customize 7-BIT NRCS Selection dialog box, 87
 Customize Keyboard dialog box, 84
 Customize Printer dialog box, 88
 Customize VTE Display dialog box, 78
 Customize VTE General dialog box, 80
 Customize VTE Window dialog box, 75
 general settings, 80 to 83
 keyboard settings, 84 to 86
 saving and recalling settings, 74
 Customize Security Password dialog box, 128
 Customize Security Password problems, 184
 Customizing the VT1000
 DECwindows Customize utility, 112
 from the host, 112
 Customizing the VT1000 Terminal Manager window, 112

D

Data processing keys, 117, 157
 DEC-423 connectors, 201
 DEC Technical character set, 176 to 177
 DECwindows

DECwindows (Cont.)
 overview, 3
 DECwindows sessions
 See X window sessions
 Default options
 choosing, 62
<X> Delete button, 85
 Diacritical keys, 161
 Diagnostic messages, 92
 Dialog boxes
 description, 60
 Digital manuals
 See Related documentation, 195
 Display Connection Requests button, 133
 Display Cursor button, 79
 Display Diagnostics Messages button, 134
 Display language
 choosing, 32 to 33
 Display Rejected Connection Requests button, 134
 Double clicking
 defined, 53
 Dragging
 defined, 53

E

Echoing data to the screen, 81
 Editing keypad, 155
 Edit menu, 69
 Select All, 71
 Ending a session, 108
Enter key, 155
 Error messages, 187
 See Diagnostic messages
 ESC character, 86
 Ethernet problems, 186

F

- F1** (Hold) key, 156, 199
- F2** (Print) key, 88, 156
- F5** (Break) key, 83, 156, 201
- Factory-default settings, recalling, 75, 114
- Font path
 - effect of double-size characters, 180
- Fonts
 - font path settings, 147 to 150
 - font size and window size, 76
 - for VTE windows, 77
 - LAT font paths, 38
 - TFTP font paths, 44
- Function keys, 153, 156

G

- Group codes
 - adding, 140
 - enabling, 140
 - removing, 140
- Group Codes scroll box, 139
- [Group Shift]** key (German), 154, 162

H

- Hexadecimal key sequences, 164
- Hold key
 - See **F1** key
- Host-based window manager, 131
- Host port
 - connections, 104
- Host system connections
 - VT1000 Terminal Manager settings, 93 to 103
- Host systems
 - accessing LAT hosts, 96
 - accessing TCP/IP hosts, 102
 - group codes, 139

Host systems (Cont.)

- software support, 12

I

- Icon
 - expanding to a window, 58
- Icon Box, 131
 - rearranging icons in, 58
 - storing a window in, 57
- Icons
 - selecting icon names, 78
- Indicator lights, 158
- Input buffer, 199
- Input focus
 - giving a window, 55
- Installation, 11 to 30
- IP addresses, 102, 142
 - BOOTP address resolution, 42
 - domain name, 145
 - entering, 42
 - entering manually, 143
 - primary name server, 145
 - secondary name server, 145
- IP address formats, 103
- IP subnet mask
 - entering, 42
- IP Subnet Mask, 143

K

- [<>]** key, 86, 154
- Keyboard, 3, 151 to 159
 - auto repeat feature, 85
 - connection, 18
 - editing keypad, 155
 - figure, 152
 - indicator lights, 158
 - local echo, 81
 - main keypad, 152
 - function keys, 153
 - model number location, 34
 - numeric keypad, 155

Keyboard (Cont.)
 problems, 185
 top-row function keys, 156
 warning bell, 84
 Keyboard dialect, 151
 Keyboard language, choosing, 33 to 35
 Keyboard model
 setting, 116
 Keyboard settings
 Terminal Manager window, 115 to 117
 Keyboard type, 151
 Keyclick, 159
 Keyclick volume, 116

L

Language
 display, 118
 keyboard, 116
 LA printers
 print settings for, 90, 120
 LAT communication protocol, 4
 address, 92
 creating a video terminal window, 95
 font paths, 38, 148
 functions, 197
 LAT group codes
 entering, 36
 LAT Terminal Window Service
 Select dialog box, 95
 password security, 128
 remote X window sessions, 214
 security, 122
 settings, 138
 tuning performance, 140
 X window and DECwindows
 sessions, 100
 LAT Font Path button, 148
 Lights
See Indicator lights
 Little font setting, 77

Local Echo button, 81
 Locator device
 enabling reports, 171
 locator report, 172
 locking and unlocking, 170
 request locator position, 174
 select locator events, 175
 Lock Customize Security button, 126
 Locked Screens Visible button, 126
 Locking customize dialog boxes, 125
 Lock key, 153
 setting, 116
 Lock Terminal Manager Customize
 button, 126
 Lock UDKs button, 81
 Lock User Features button, 81
 Lock VTE Customize button, 126
 Logging out, 69

M

Margin bell, 159
 Margin Bell button, 84
 Memory
 checking available memory, 93
 Memory Remaining scale, 30
 Memory controller board
 installation, 21 to 30
 ordering, 194
 Menus
 pull-down menu, 59
 Messages
 controlling displays, 132
 displaying, 133
 Messages region
 header text, 134
 scroll lines saved, 134
 Modems, 200
 breaking communication, 157
 connecting, 200
 ordering, 194
 Monitor
 selection switch, 17

6 Index

Monitor (Cont.)

- specifications, 14

Monitors, 2

- problems, 184

Mouse, 3

- button layout, 119
- buttons defined, 52
- connection, 18
- figure, 52
- problems, 185
- settings, 119
- using, 52
- using the editing keypad as a mouse, 155, 156

N

Network

- hardware support, 12

Network addresses, 92

Network problems, 186

Network protocols

- See also* LAT and TCP/IP

Newline button, 80

Nodes

- connecting to, 98
- viewing the list of, 98

No Form Feed button, 89, 122

Normal Cursor Keys button, 81

Normal font setting, 77

Numeric keypad, 155

Numeric Keypad button, 82

O

OK push button, 74, 113

Operating systems, 4

Option button

- defined, 61

Options

- ordering, 194

P

Parity, 137

Part numbers

- options, 194

Password security settings, 128

Paste menu item, 70

Pasting text, 69, 71

- host synchronization, 70

- QuickCopy, 72

Pausing a session, 106

- resuming the session, 108

[PF1] to [PF4] keys, 155

Pointer settings, 119

Pointing

- defined, 53

Ports

- connecting to, 98

Power supply, 23

Power switch, 19

Power-up self-test, 187

Preferred Routes scroll box, 146

Preferred Services scroll box, 98

Pressing

- defined, 53

Printer controller mode, 89

Printer port

- choosing the function of, 137

- connections, 104

Printers, 110

- baud rate, 136

- problems, 185

Printing

- canceling, 111

- from a video terminal window, 90

- from the host system, 88

- from VTE windows, 87

 - printed data type, 89

 - print extent mode, 89

 - print FF mode, 89

 - Scroll Area button, 89

- pixel aspect ratio, 121

- printer status, 111

Printing (Cont.)

- print FF mode, 88, 122
- Print Screen menu, 110
- ribbon or toner saver, 122
- rotated image, 121
- the screen, 88
- under host control, 89

Print key

See **[F2]** key

Print screen settings, 120**Problems**

See Solving problems

Programming

- character sets, 178
- enable filter rectangle (DECEFR), 170
- enable locator reports (DECELR), 171
- locator device commands, 169 to 176
- locator report (DECLRP), 172
- reports, 180 to 182
- request locator position (DECRQLP), 174
- Select locator events (DECSLE), 175

Pull-down menu

- displaying, 59

Push button

- defined, 62

Push-to-back button, 59**Q****QuickCopy, 72****Quitting**

- a remote session manager, 109
- LAT X session, 101
- VTE window, 69

R**Recalling feature settings**

- Terminal Manager window, 114
- VTE windows, 74

ReGIS graphics, 73**Related documentation, 195****Remote session managers, 100****Remote window manager, 131****Reset Terminal menu item, 68****Resetting the terminal**

- secure reset, 93

Resize button

- using, 56

Resize cursor, 56**Resizing the display font, 76******[Return]** key, 153**

- selecting the function of, 80

ROM board

- installation, 21 to 30

Rotate/Scale Picture button, 121**S****Saving feature settings**

- Terminal Manager window, 114
- VTE windows, 74

Scale

- defined, 61

Screen background pattern, 131

- color, 132

Screen saver feature, 130**Scroll Area button, 89****Scroll bar**

- using, 63

Scrolling, 63

- preventing, 85

Scroll region, 63**Secure reset count, 93****Security settings, 122**

- accepting connections when idle, 125

8 Index

Security settings (Cont.)

- adding authorized users, 124
 - authorizing LAT or TCP/IP connections, 123
 - displaying a locked dialog box, 127
 - locking customize dialog boxes, 125
 - removing authorized users, 125
 - security password, 128
- Select All menu item, 70
- Serial communication, 198
- baud rate, 136
 - settings, 134
- Serial connections
- host port, 104
 - printer port, 104
- Serial connector, 12
- Serial connectors, 18
- Service, 188 to 189
- Services
- LAT, 97
 - Preferred Services list, 98
 - service list, 98
 - X window, 100
- Session manager, 47
- Session menu, 106, 108
- Sessions
- ending, 47, 108
 - LAT font paths
 - entering, 38
 - LAT group codes
 - entering, 36
 - opening
 - overview, 93
 - pausing, 106
 - quitting from a remote session manager, 109
 - starting, 35 to 47, 96
 - on an ULTRIX or UNIX system, 41 to 47
 - on a VMS system, 36 to 41
 - on the serial host port, 47
 - X window on a VMS system, 36 to 41

Sessions (Cont.)

- video terminal, 35
 - X window, 35
- Set-up
- See* Customize menu
- Shift clicking
- defined, 53
- Shift key, 153
- Shrink-to-icon button, 57
- SIMM card
- installation, 21 to 30
 - ordering, 194
- Site preparation, 11 to 13
- Sixel graphics, 73
- Sixel printing, 110
- Slider
- using in scroll bar, 63
- Solving problems, 183
- Specifications, 190 to 193
- Start Session dialog box, 41
- Status display, 79
- Stepping arrow, 63
- System box, 2
- connectors, 17
 - problems, 183
- System management tasks, 204
- System requirements, 4
- Systems
- See* Host systems

T

- Tab** key, 153
- TCP/IP
- IP address, 92
- TCP/IP communication protocol, 4
- creating a video terminal window, 102
 - entering an IP address and host name, 102
 - functions, 198
 - name server, 143
 - Name Server settings, 144
 - password security, 128

- TCP/IP communication protocol (Cont.)
 - routing tables, 143
 - routing tables settings, 145
 - security, 122
 - settings, 142
 - TELNET communication protocol, 4
 - entering a port number, 103
 - TELNET Terminal Window Host
 - Select dialog box, 45, 102
 - Temporary Routes scroll box, 146
 - Terminal ID button, 82
 - Terminal Mode button, 83
 - Terminal size setting, 77
 - Text entry fields
 - typing in, 61
 - TFTP font path, 149
 - TFTP Font path button, 148
 - TFTP font paths, 44
 - ThinWire connector, 12, 18
 - Tilde key, 86
 - Title bar
 - moving a window with, 55
 - Toggle button
 - defined, 61
 - Typewriter keys, 117
- U**
- ULTRIX operating system, 4
 - creating a video terminal window, 102
 - font paths, 44
 - IP addresses, 42
 - running the DECwindows session manager, 46
 - sessions on the host or printer port, 104
 - starting a session, 35, 41 to 47
 - video terminal, 47
 - TCP/IP Name Server settings, 144
 - TCP/IP routing tables settings, 145
 - TCP/IP settings, 142
 - ULTRIX operating system (Cont.)
 - UWS version required, 12
 - version required, 12
 - X window or DECwindows sessions, 102
 - UNIX operating system, 4
 - creating a video terminal window, 102
 - font paths, 44
 - IP addresses, 42
 - running the DECwindows session manager, 46
 - sessions on the host or printer port, 104
 - starting a session, 35, 41 to 47
 - video terminal, 47
 - TCP/IP Name Server settings, 144
 - TCP/IP routing tables settings, 145
 - TCP/IP settings, 142
 - version required, 12
 - X window or DECwindows sessions, 102
 - Update Know Services button, 98
 - UPSS DEC Supplemental button, 82
 - UPSS ISO Latin 1 Supplemental button, 82
 - User-defined keys, 157
 - locking, 81
 - User-preferred supplemental sets, 82
 - Using the VT1000 Terminal Manager window, 91
- V**
- Video terminal sessions
 - description, 35
 - on an ULTRIX or UNIX system, 41 to 47
 - on a VMS system, 36 to 41
 - Video terminal window, 47
 - See also* VTE windows
 - customizing, 112

- VMS operating system, 4
 - creating a video terminal window, 95
 - LAT group codes, 139
 - LAT settings, 138
 - sessions on the host or printer port, 104
 - starting a session, 35
 - video terminal, 36 to 41, 47
 - X window, 36 to 41
 - version required, 12
 - X window and DECwindows sessions, 100
 - X window sessions
 - remote, 214
- VT1000
 - network addresses, 92
- VT1000 terminal
 - components, 1
 - overview, 1 to 7
 - parts checklist, 16
- VT1000 Terminal Manager window, 32, 91 to 150
 - Create menu, 93
 - Customize window, 112
 - features, 91
 - figure, 91
 - Print Screen menu, 110
 - Session menu, 106
- VTE window, 7
 - quitting, 69
- VTE windows, 66 to 90
 - ,< and .> keys, 85
 - angle bracket keys, 86
 - answerback message, 83
 - Auto Repeat button, 85
 - auto wrap setting, 78
 - blinking or steady cursor, 79
 - block or underline cursor, 79
 - character set selection, 81, 82
 - choosing a 7-bit NRC character set, 86
 - clearing, resetting, or leaving, 68
 - Commands menu, 68

VTE windows (Cont.)

- Conceal Answerback Message button, 83
- creating
 - on an ULTRIX or UNIX system, 102
 - on a VMS system, 95
 - on the host or printer port, 104
- cursor key functions, 81
- Customize 7-BIT NRCS Selection dialog box, 87
- Customize Keyboard dialog box, 84
- Customize menu, 73
- Customize VTE General dialog box, 80
- Customize VTE Printer dialog box, 88
- Customize VTE Window dialog box, 75
- customizing, 72 to 90
- display cursor, 79
- display settings, 78
- font size, 77
- format, 66
- <X> function, 85
- general settings, 80 to 83
- icon name, 78
- keyboard settings, 84 to 86
- keypad function, 82
- Lock UDKs button, 81
- Lock User Features button, 81
- Margin Bell button, 84
- printer settings, 87 to 90
- rows and columns, 77
- saving and recalling settings, 74
- status display, 79
- Terminal ID button, 82
- Terminal Mode button, 83
- text and window background, 79
- tilde key as ESC key, 86
- VTE Customize menu, 80
- Warning Bell button, 84

W

- Warning bell, 115, 159
- Warning Bell button, 84
- 2-Way Printer Port button, 89
- Windows, 51 to 65
 - changing the size of, 56
 - changing the size of icons, 131
 - defined, 53
 - expanding from an icon, 58
 - foreground color, 132
 - moving, 55
 - popping to the top of the stack, 59
 - selecting, 55
 - settings
 - Terminal Manager window, 129
 - VTE windows, 75
 - shrinking, 57
 - stacking, 59

- VT1000-DECwindows
 - differences, 51

- Window title, selecting, 77

X

- XOFF signal, 137
- X window client, 46
- X window sessions
 - canceling a login box, 101
 - creating
 - on an ULTRIX or UNIX system, 102
 - on a VMS system, 100
 - description, 35
 - on an ULTRIX or UNIX system, 41 to 47
 - on a remote VMS system, 214
 - on a VMS system, 36 to 41
 - TCP/IP X window session, 105
- X Window System, 3