

**TL82X Automated Tape Library
for DLT Cartridges**

**Operator's
Guide**

EK-TL820-OP

Revision B01

EK-TL820-OP, Revision B01, March 15, 1996, Made in USA.

© Copyright 1994-1996, Digital Equipment Corporation. All rights reserved.

Your right to copy this manual is limited by copyright law. Making copies or adaptations without prior written authorization of Digital Equipment Corporation is prohibited by law and constitutes a punishable violation of the law.

Digital Equipment Corporation provides this publication "as is" without warranty of any kind, either express or implied, including but not limited to the implied warranties of merchantability or fitness for a particular purpose. Digital Equipment Corporation may revise this publication from time to time without notice.

DLT and DLTape are claimed as trademarks of Quantum Corporation in the U.S. and other countries.

FCC STATEMENT

This equipment has been tested and found to comply with the limits for a Class A digital device, pursuant to Part 15 of the FCC Rules. These limits are designed to provide reasonable protection against harmful interference when the equipment is operated in a commercial environment. This equipment generates, uses, and can radiate radio frequency energy and, if not installed and used in accordance with the instruction manual, may cause harmful interference to radio communications.

Any changes or modifications made to this equipment may void the user's authority to operate this equipment.

Operation of this equipment in a residential area may cause interference in which case the user at his own expense will be required to take whatever measures may be required to correct the interference.

This device complies with Part 15 of the FCC Rules. Operation is subject to the following conditions: (1) this device may not cause harmful interference, and (2) this device must accept any interference received, including interference that may cause undesired operation.

CISPR-22 WARNING!

This is a Class A product. In a domestic environment this product may cause radio interference in which case the user may be required to take adequate measures.

ACHTUNG!

Dieses ist ein Gerät der Funkstörgrenzwertklasse A. In Wohnbereichen können bei Betrieb dieses Gerätes Rundfunkstörungen auftreten, in welchen Fällen der Benutzer für entsprechende Gegenmassnahmen verantwortlich ist.

ATTENTION!

Ceci est un produit de classe A. Dans un environnement domestique, ce produit peut causer des interférences radio lectriques. Il appartient alors a l'utilisateur de prendre les mesures appropriées.

NOTICE FOR USA AND CANADA ONLY

If shipped to USA, use the UL LISTED power cord specified below for 100-120 V operation. If shipped to CANADA, use the CSA CERTIFIED power cord specified below for 100-120V operation.

Plug Cap	Parallel blade with ground pin (NEMA 5-15P Configuration)
Cord	Type: SJT, three 16 or 18 AWG wires
Length	Maximum 15 feet
Rating	Minimum 10 A, 125 V

ATTENTION

LIRE LA REMARQUE DANS LE MODE D'EMPLOI

REMARQUE

CETTE REMARQUE NE CONCERNE QUE LES ÉTATS-UNIS ET LE CANADA.

En cas d'envoi aux États-Unis, utiliser le cordon d'alimentation certifié UL et convenant pour 100-120 V.

En cas d'envoi au CANADA, utiliser le cordon d'alimentation CERTIFIÉ CSA et convenant pour 100-120 V.

Fiche	Broches paralléus avec une broche de mise à la terre (configuration NEMA 5-15P)
Cordon	Type: SJT, trifilaire 16 ou 18 AWG
Longueur	Maximum 15 pieds
Capacité	Minimum 10 A, 125 V

ZU IHRER SICHERHEIT

Vorsicht

Um Feuergefahr und die Gefahr eines elektrischen Schlages zu vermeiden, darf das Gerät weder Regen noch Feuchtigkeit ausgesetzt werden.

Um einen elektrischen Schlag zu vermeiden, darf das Gehäuse nicht geöffnet werden. Überlassen Sie Wartungsarbeiten stets nur einem Fachmann.

Achtung

Da der interne Laserstrahl in Ihre Augen eindringen und Verletzungen verursachen kann, darf das Gehäuse nicht selbst geöffnet werden. Überlassen Sie Wartungsarbeiten stets nur einem Fachmann.

Die Verwendung von Brillen, Kontaktlinsen usw. vergrößert die Gefahr.

Zur besonderen Beachtung

Zur Sicherheit

Sollte ein fester Gegenstand oder Flüssigkeit in das Geräteinnere gelangen, trennen Sie das Gerät von der Wandsteckdose ab und lassen Sie es von einem Fachmann überprüfen, bevor Sie es weiter verwenden.

Zum Abziehen des Kabels fassen Sie stets am Stecker und niemals am Kabel selbst an.

Zur Aufstellung

Stellen Sie das Gerät weder auf einer weichen Unterlage (z. B. Decke, Teppich) noch in der Nähe von Vorhängen, Tapeten usw. auf, da hierdurch die Ventilationsöffnungen blockiert werden können.

Zur Reinigung

Verwenden Sie zur Reinigung des Gehäuses, des Bedienungspultes und der Bedienungselemente ein trockenes, weiches Tuch oder ein weiches, leicht mit mildem Haushaltsreiniger angefeuchtetes Tuch. Lösemittel wie Alkohol oder Benzin dürfen nicht verwendet werden, da diese die Gehäuseoberfläche ungreifen.

LASER STATEMENT

CLASS 1 LASER PRODUCT

CAUTION - This product contains a Class II laser. Laser light - DO NOT stare into beam. Avoid Exposure - Laser Light is emitted from the barcode scanner.

CAUTION - Use of controls or adjustments or performance of procedures other than those specified herein may result in hazardous exposure.

LASER KLASSE 1

VORSICHT : Dieses Produkt Enthält Einen Laser Der Kategorie II. Laserstrahlen - Der Strichcode-scanner Gibt Laserstrahlen aus. VERMEIDEN SIE jeden Blickkontakt und direkten körperlichen Kontakt mit diesen Strahlen.

VORSICHT : Ein nicht ordnungsgemäßer (siehe hier enthaltene Anweisungen) Einsatz bzw. Änderungen der Betriebsleistung können einen gesundheitsgefährdenden Kontakt zur Folge haben.

APPAREIL À LASER DE CLASSE 1

ATTENTION : ce produit relève de la classe laser II. Rayonnement laser - NE PAS fixer des yeux le rayon. Eviter les expositions - Le rayonnement laser est émis à partir du lecteur optique de code barre.

ATTENTION : L'utilisation de contrôles ou d'ajustements de performance des procédures autres que ceux indiqués ici peut entraîner une exposition dangereuse.

PRODUCTO LÁSER DE CLASE 1

!ATENCIÓN! Este producto contiene laser de clase II. Luz laser - NO mire el rayo. Evite la exposición: la luz laser se emite desde el explorador de código de barras.

!ATENCIÓN! El uso de los controles o ajustes para realizar procedimientos diferentes de los especificados aquí puede provocar una exposición peligrosa.

LUOKAN 1 LASERLAITE

ATTENZIONE: questo prodotto emette una luce laser di Classe II. NON guardare il fascio di luce ed evitare di esporsi alla fonte del laser. Il fascio di luce laser è emesso dal dispositivo di scansione del codice a barre.

ATTENZIONE: l'uso di comandi o regolazioni per eseguire le procedure che non siano quelli specificati in questa documentazione può causare rischi all'incolumità delle persone.

Table of Contents

Introduction

Purpose	1-3
Conventions Used in this Guide	1-4
References	1-4
Documentation and Contacts	1-4

Library Overview

General Library Description	2-3
Front Control Panel	2-6
Tape Drive Status Control Panel	2-8
Door Handle and Safety Switch	2-10
Rear Connector Panel	2-11
Multi-Unit Controller	2-11
Passthrough Conveyor Mechanism	2-16
Inport/Outport Device	2-17
Cartridge/Tape Drive Compatibility	2-18

Operating Instructions

Mounting and Removing Bin Packs	3-3
Mounting a Bin Pack on the Carousel	3-3
Inserting and Removing Bin Pack Cartridges	3-6
Loading and Unloading Cartridges via the IOD	3-8
Loading Cartridges into the IOD Inport Door	3-8
Unloading Cartridges from the IOD Outport Door	3-8
Manually Unloading the Tape Drive	3-10
Cleaning and Lubrication	3-12
Cleaning and Lubricating the Vertical Rails	3-12
Cleaning and Lubricating the Extension Rails	3-13

Troubleshooting

Error Messages sent to the Host	4-3
Status Codes	4-4
Other Problems	4-8

Glossary

Index

List of Figures

Figure 1: TL826 Library Front View.....	2-5
Figure 2: Front Control Panel	2-6
Figure 3: Tape Drive Status Control Panel	2-8
Figure 4: Front Door Handle	2-10
Figure 5: TL820 Library Cable Connections.....	2-12
Figure 6: TL822 Library Cable Connections	2-13
Figure 7: TL826 Library Cable Connections	2-14
Figure 8: PTM Location	2-16
Figure 9: IOD Location.....	2-17
Figure 10: Mounting a Bin Pack on the Carousel.....	3-5
Figure 11: Loading an IOD	3-9
Figure 12: Tape Drive Status Control Panel	3-11

List of Tables

Table 1:	TL82X Drive and Tape Configurations	1-3
Table 2:	TL82X Documentation	1-5
Table 3:	TL82X Cartridges/Tape Drives.....	2-4
Table 4:	Front Control Panel Description	2-7
Table 5:	Tape Drive Status Control Panel Description	2-9
Table 6:	SCSI Port/Address for the TL820 Tape Library (Default).....	2-12
Table 7:	SCSI Port/Address for the TL822 Tape Library (Default).....	2-13
Table 8:	SCSI Port/Address for the TL826 Tape Library (Default).....	2-15
Table 9:	Cartridge/Tape Drive Compatibility	2-18
Table 10:	Status Codes	4-4
Table 11:	Common TL82X Problems	4-8

Introduction

1

Purpose	1-3
Conventions Used in this Guide	1-4
References	1-4
Documentation and Contacts	1-4

Purpose

The *TL82X Operator's Guide* contains information about the following tape libraries: TL820 (part number TL820-xx), TL822 (part number TL822-xx), and TL826 (part number TL826-xx). The part number for each library is printed on the product label located on the rear of the unit. Table 1 identifies the configuration difference between the TL82X tape libraries.

Table 1: TL82X Drive and Tape Configurations

Tape Library	Number of Tape Drives	Drive Type	SCSI Configurations
TL820	3	TZ87	2-wire
TL822	3	TZ88N	3-wire
TL826	6	TZ88N	6-wire

This manual describes the basic operating functions of each tape library after it has been installed.

Note *This manual does not contain information on how to use the host software which controls each of the above libraries.*

This manual includes the following:

- Chapter 2, "TL82X Library Description," describes your tape library and how it operates.
- Chapter 3, "Operating Instructions," describes safety precautions, how to turn the power on and off, and how to load and remove bin packs and cartridges.
- Chapter 4, "Troubleshooting," describes how to diagnose problems and determine whether you can fix a problem, or if an authorized field service representative is required.
- This manual also includes a Glossary for reference. Use the Table of Contents, List of Figures, List of Tables, and Index to find a specific section or to locate information on a particular subject.

Conventions Used in this Guide

 **WARNING** *Paragraphs marked by the warning icon indicate potential hazards to personal safety and are included to prevent injury.*

 **CAUTION** *Paragraphs marked by the caution icon indicate potential hazards to equipment and are included to prevent damage to equipment.*

References

Documentation and Contacts

To obtain further information and/or copies of documentation on this product, contact:

U.S. Software Supply Business
Digital Equipment Corporation
10 Cotton Road
Nashua, New Hampshire 03063-1260

The part number of each document will be required at the time of order.

Table 2: TL82X
Documentation

Document Number	Document Title	Document Description
EK-TL820-PG	TL82X Facilities Planning and Installation Guide	This guide describes facility requirements and installation procedures for the TLX82X tape library.
EK-TL820-SV	TL82X Field Service Manual	This manual contains procedures for field isolation and replacement/repair of faulty components in a library, as well as instructions and guidelines for periodic maintenance.
EK-TL820-SM	TL82X Diagnostic Software User's Manual	This manual describes how to install and use the TL82X Diagnostic Software Package developed for field service personnel.
EK-TL820-SG	TL82X Software Interface Guide	This guide is for software engineers developing the application and hierarchical mass storage software that accesses the TL82X.
EK-TZ87-OM	TZ87 Series Cartridge Tape Subsystem Owner's Manual	This document describes the TZ87 Tape Drive and provides operating instructions and troubleshooting procedures.
EK-TZ88X-OM	TZ88 Series Cartridge Tape Subsystem Owner's Manual	This document describes the TZ88 Tape Drive and provides operating instructions and troubleshooting procedures.

Library Overview

2

General Library Description.....	2-3
Front Control Panel	2-6
Tape Drive Status Control Panel	2-8
Door Handle and Safety Switch.....	2-10
Rear Connector Panel	2-11
Multi-Unit Controller	2-11
Passthrough Conveyor Mechanism.....	2-16
Inport/Outport Device	2-17
Cartridge/Tape Drive Compatibility	2-18

General Library Description

The TL82X library is an automated tape library for DLT cartridges. Depending on the model you have (TL820, TL822, or TL826), your tape library will store from 176 to 264 cartridges and have from three to six tape drives (see Table 2).

The major components of the library are illustrated in Figure 1 on page 2-5.

The TL82X library has a front door that can be opened for easy bulk loading of bin packs, each containing a maximum of 11 cartridges. The inport/outport device (IOD) allows single cartridges to transfer in and out of the library without interrupting operation.

The bin packs are arranged on an eight-sided carousel with two to three bin packs per face, depending on the model of the library you have. A bar code reader is provided for quick and accurate inventories.

The tape drives are mounted in the housing above the carousel and in-line with the carousel front face. A gripper moves horizontally on an extension axis which in turn is attached to vertical rails in the front door.

The TL82X library is driven by a host computer using the SCSI 2 standard robotics command set. A single host can drive up to five libraries using a multi-unit controller (MUC). (Refer to Figures 5 through 7.) The MUC enables libraries to be linked together so that the pass-through conveyor mechanisms (PTMs) can transfer cartridges back and forth.

Upon receipt of the appropriate command from the host computer, the control electronics command the robotic mechanism to remove a cartridge from any storage bin, raise it up in front of a tape drive, and insert the cartridge into the drive. The host computer, also directing the tape drives, can then issue commands such as read, write, unload or clean, directly to the tape drive for action. (Note that the automatic tape cleaning feature is available and can be enabled/disabled via the host or diagnostic software. Refer to Document EK-TL820-SM, *TL82X Diagnostic Software User's Manual*, and read the discussion of this feature in the "Glossary.")

Since the TL82X library is controlled by the host, normal operation of the library requires minimal interaction. The only procedures you must perform to maintain normal operation are:

- loading and removing bin packs and/or individual cartridges.
- loading and unloading cartridges through the IOD.
- troubleshooting any problems that occur.

Table 3: TL82X
Cartridges/Tape Drives

Tape Library	Maximum Number of Cartridges	Number of Tape Drives
TL820	264	3 ^a
TL822	264	3 ^b
TL826	176	6 ^c

- a. The TL820 library uses three TZ87 tape drives.
b. The TL822 library uses three TZ88N tape drives.
c. The TL826 library uses six TZ88N tape drives.

Figure 1: TL826 Library
Front View

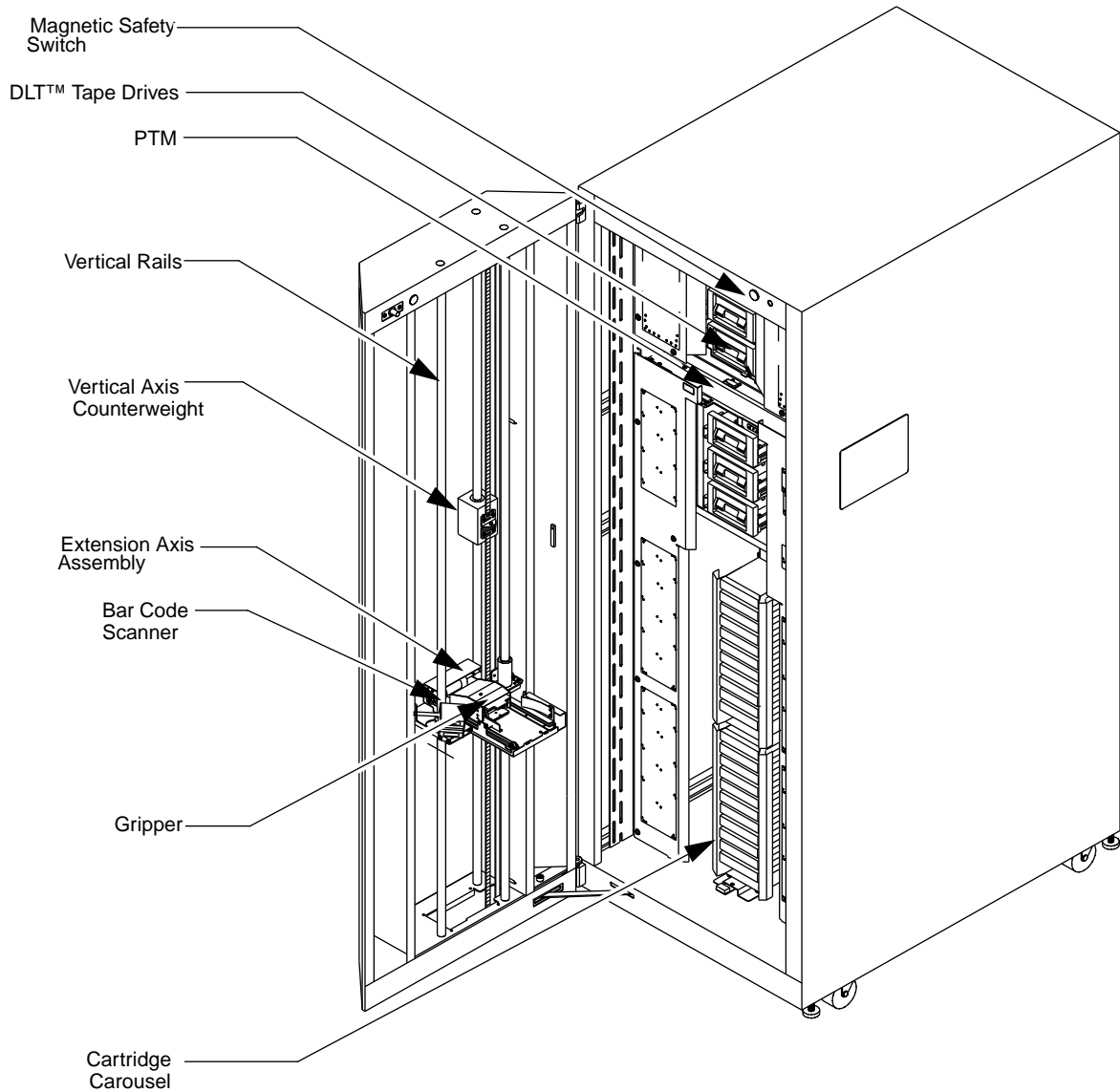

TG00001a

Front Control Panel

The front control panel, located on the front door of the TL82X library, is shown in Figure 2. The FAULT and STANDBY indicators, along with the status display are located on the top half of the control panel. The STOP, STANDBY, and ← → control buttons are located on the lower half.

Figure 2: Front Control Panel

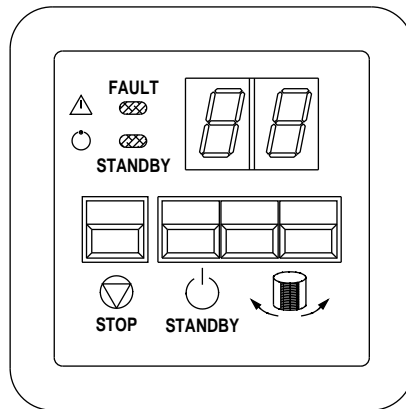

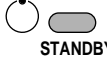
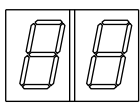
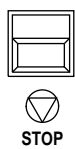
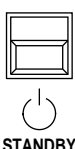
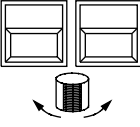

Table 4: Front Control Panel Description

Button/Indicator	Description	Function
	FAULT indicator	Lights when one of the following occurs: 1) the library door is open. 2) the rear panel is removed. 3) you press the STOP button. 4) there is a system failure.
	STANDBY indicator	Lights when you press the STANDBY button to take the library off-line.
	status display	Displays codes that describe the operating state of the library. For status display code descriptions, see Chapter 4.
	STOP button	Allows you to disconnect power to the library's robotic equipment for the following situations: 1) opening the door to access the bin packs. 2) during the power-off procedure. 3) in an emergency. Press the STOP button to disconnect power to the robotic equipment.
	STANDBY button	Toggles the library between the on-line and off-line states. Press the STANDBY button to place the library off-line. When the library is off-line it cannot receive commands from the host.
	← and →	Rotates the carousel. Used when mounting or removing bin packs or individual cartridges. The system must be off-line for these buttons to operate.

Tape Drive Status Control Panel

The tape drive status control panel is located inside the front door on the tape drive cosmetic panel. Figure 3 illustrates the control panel for the TL820 and TL822, which have three tape drives each. The control panel for the TL826 is identical, except that there are two control panels for the six drives.





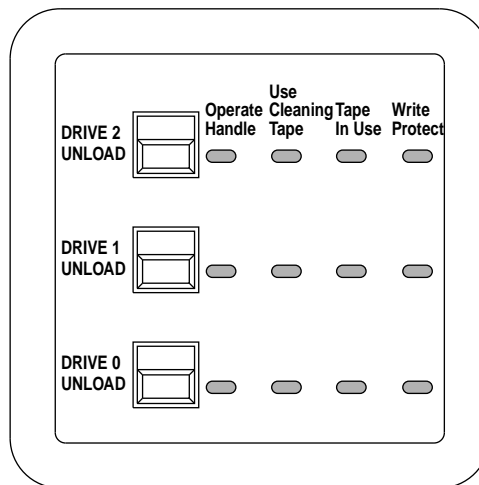

The tape drive unload buttons and indicators are described in Table 5 on page 2-9.

Figure 3: Tape Drive Status Control Panel



Note *The control panel is functionally identical to the TZ87 or TZ88N tape drive front panel described in Documents EK-TZ87-OM, TZ87 Series Cartridge Tape Subsystem Owner's Manual; and EK-TZ88X-OM, TZ88 Series Cartridge Tape Subsystem Owner's Manual. See this manual for a more detailed description of the tape drive unload buttons and indicators.*

Table 5: Tape Drive
 Status Control Panel
 Description

Button/Indicator	Description	Function
DRIVE 2 UNLOAD 	DRIVE 2 UNLOAD button	The three drive unload buttons correspond to the three TZ88N tape drives, which are numbered 0 through 2 from bottom to top.
DRIVE 1 UNLOAD 	DRIVE 1 UNLOAD button	Pressing the unload button(s) causes the: 1) tape to rewind. 2) drive to reset. 3) cartridge to unload if possible.
DRIVE 0 UNLOAD 	DRIVE 0 UNLOAD button	
Operate Handle 	Operate Handle indicator(s)	Lights when the insert/release tape drive handle is ready to operate. IMPORTANT! The tape must be completely rewound and unloaded before you remove the cartridge from the drive. Depending on tape position, this operation may take from 10 seconds to 2 minutes.
Use Cleaning Tape 	Use Cleaning Tape indicator(s)	Lights when the drive head needs cleaning, or the current cartridge is bad. After unloading the cleaning cartridge, this indicator remains lit when one of the following occurs: 1) the cleaning operation was not complete. 2) the current cartridge is bad.
Tape In Use 	Tape In Use indicator(s)	Lights after the cartridge is loaded and the tape loads into the drive.
Write Protect 	Write Protect indicator(s)	Lights when the tape is write-protected.

Door Handle and Safety Switch

Use the front door handle, which is located on the middle of the right column of the front door, to open and close the door. Keep the front door closed except when performing a procedure that requires it to be open, such as mounting a bin pack on the carousel.

1. To open the door, turn the door handle counter clockwise.
2. To close the door, push the door shut and turn the door handle clockwise.

The door has a safety switch (see Figure 1 on page 2-5) that disconnects power to the library's robotic equipment when the door is open. The safety switch automatically resets when the door is closed.



DO NOT override the safety switch. Operating the library with the safety switch defeated could cause personal injury from moving components, electrical shock, or damage the unit.



To prevent injury from moving components, always press the STOP button before opening the front door.

Figure 4: Front Door Handle

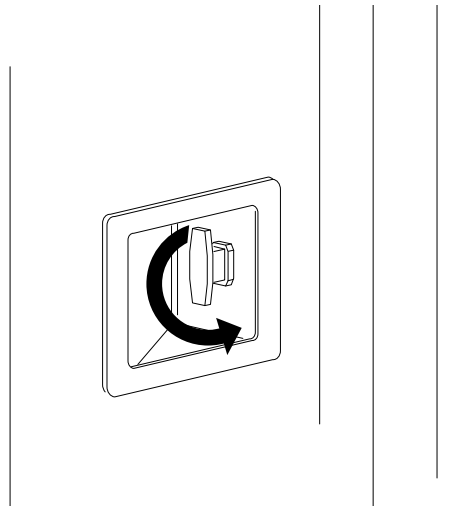

Rear Connector Panel

The rear connector panel is located at the bottom rear of the TL82X library. All power and communications cable connections to the library are made on the rear connector panel.

 **CAUTION** *DO NOT remove the rear panel of the cabinet. There are no operator serviceable parts inside the rear of the cabinet.*

Multi-Unit Controller

The multi-unit controller (MUC) serves two functions:

- It is a SCSI adapter that allows the SCSI interface to control communications between the host and the library.
- It permits the host to control up to five attached library units in a multi-unit configuration.

The TL820 library has two 50-pin Centronics SCSI ports labelled: SCSI PORT A and SCSI PORT B. SCSI PORT C is used for expansion. Figure 5 on page 2-12 shows the configuration.

The TL822 library has three 50-pin Centronics SCSI ports labelled: SCSI PORT A, SCSI PORT B, and SCSI PORT C. Figure 6 on page 2-13 shows the rear panel configuration for this library model.

The TL826 library has 6-wire, 50-pin Centronics SCSI ports labelled: SCSI PORTS A-C and SCSI PORTS E-F. Figure 7 on page 2-14 shows the rear panel configuration for this library model.

With the MUC installed, the host controls the library through one of the SCSI cables, which are used to transfer data to and from the tape drives Table 6, Table 7, and Table 8 lists the SCSI ports and the respective device addresses for the TL820, TL822, and the TL826 libraries.

Note *There may be additional cable connections on the rear connector panel. Consult with your system administrator prior to connecting or disconnecting any cables. The cables connecting the TL82X SCSI ports to the host are not provided with the library. The RS-232C loopback cable and power cable are included in the accessories kit.*

Figure 5: TL820 Library
 Cable Connections

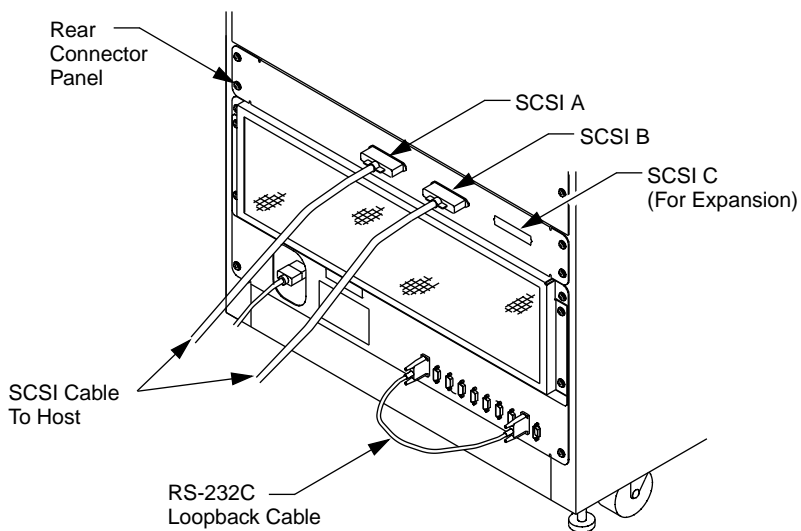
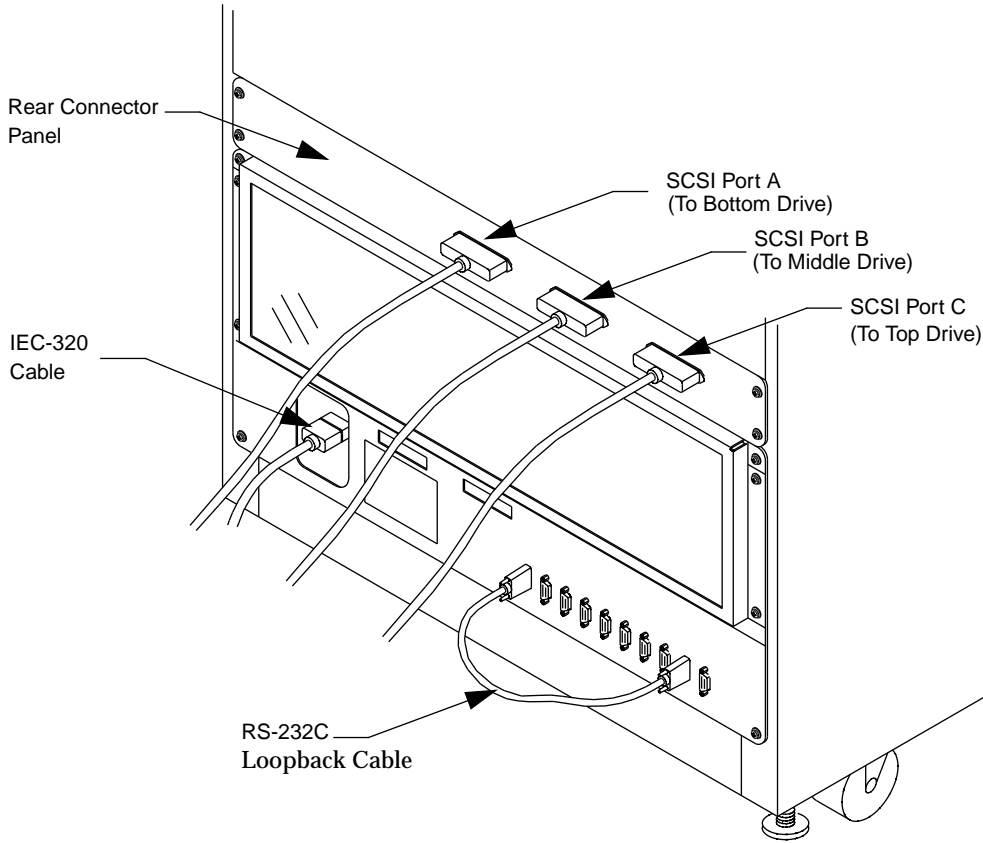

Table 6: SCSI
 Port/Address for the
 TL820 Tape Library
 (Default)

TL820 SCSI Port	MUC Address	Tape Drive Address
A	SCSI ID 2	SCSI ID 3 (bottom drive)
B	no connection	SCSI ID 4 (middle drive) and SCSI ID 5 (top drive)

Figure 6: TL822 Library
 Cable Connections



TD00007a

Table 7: SCSI
 Port/Address for the
 TL822 Tape Library
 (Default)

TL822 SCSI Port	MUC Address	Tape Drive Address
A	SCSI 2	SCSI ID 3 (bottom drive)
B	no connection	SCSI ID 4 (middle drive)
C	no connection	SCSI ID 5 (top drive)

Figure 7: TL826 Library
Cable Connections

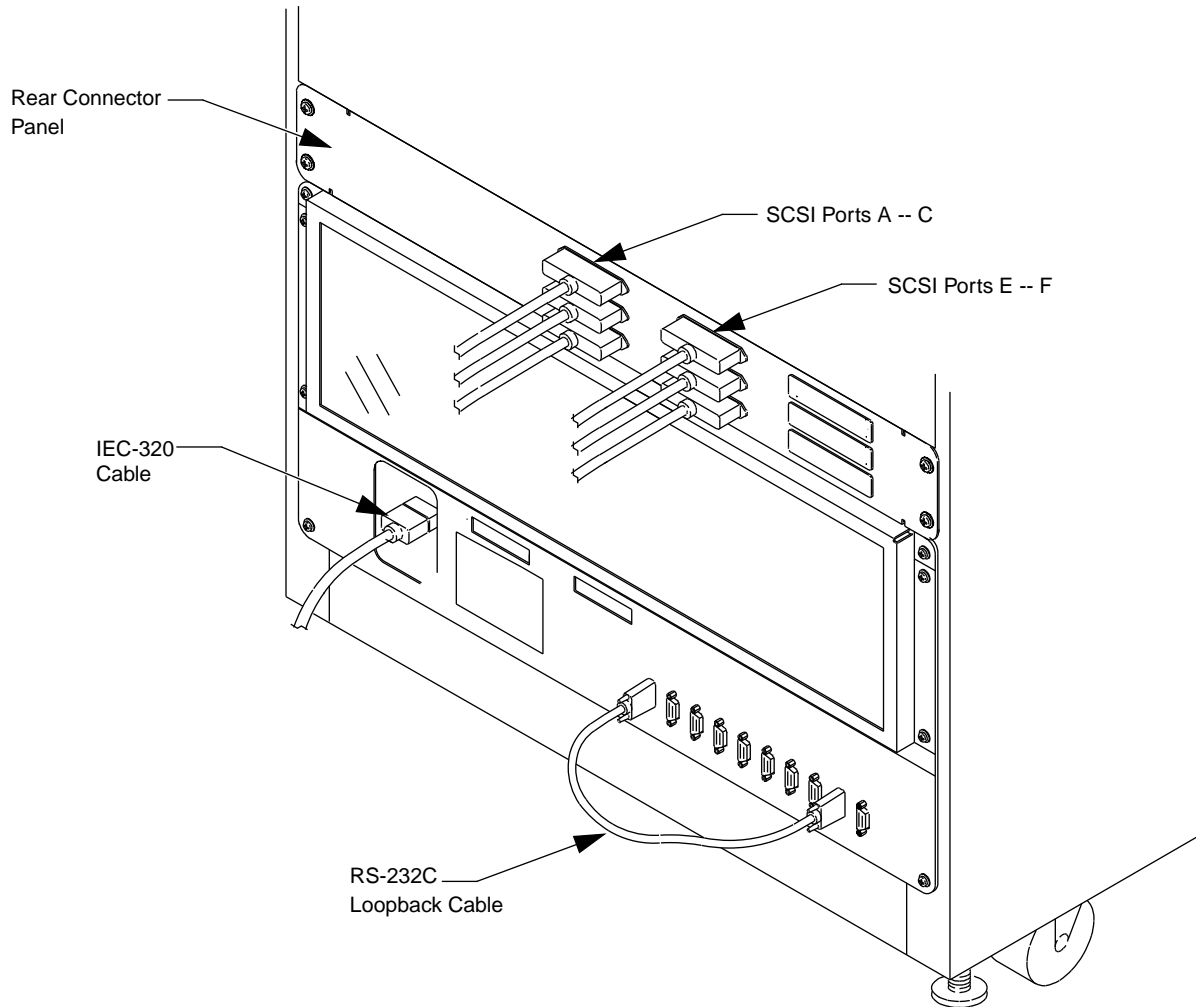

TG00007a

Table 8: SCSI
Port/Address for the
TL826 Tape Library
(Default)

TL826 SCSI Port	MUC Address	Tape Drive Address
A	no connection	SCSI ID 5 (Drive 2)
B	no connection	SCSI ID 4 (Drive 1)
C	no connection	SCSI ID 3 (bottom drive - Drive 0)
D	SCSI 2	SCSI ID 5 (top drive - Drive 5)
E	no connection	SCSI ID 4 (Drive 4)
F	no connection	SCSI ID 3 (Drive 3)

Passthrough Conveyor Mechanism

The pass-through conveyor mechanism (PTM) allows cartridges to transfer between an IOD and the TL82X, or between units in a multi-unit configuration. The PTM is located between the storage carousel and the tape drives.

The TL82X library controller controls the PTM when host commands request cartridges to move into, or out of, the library.

Figure 8: PTM Location

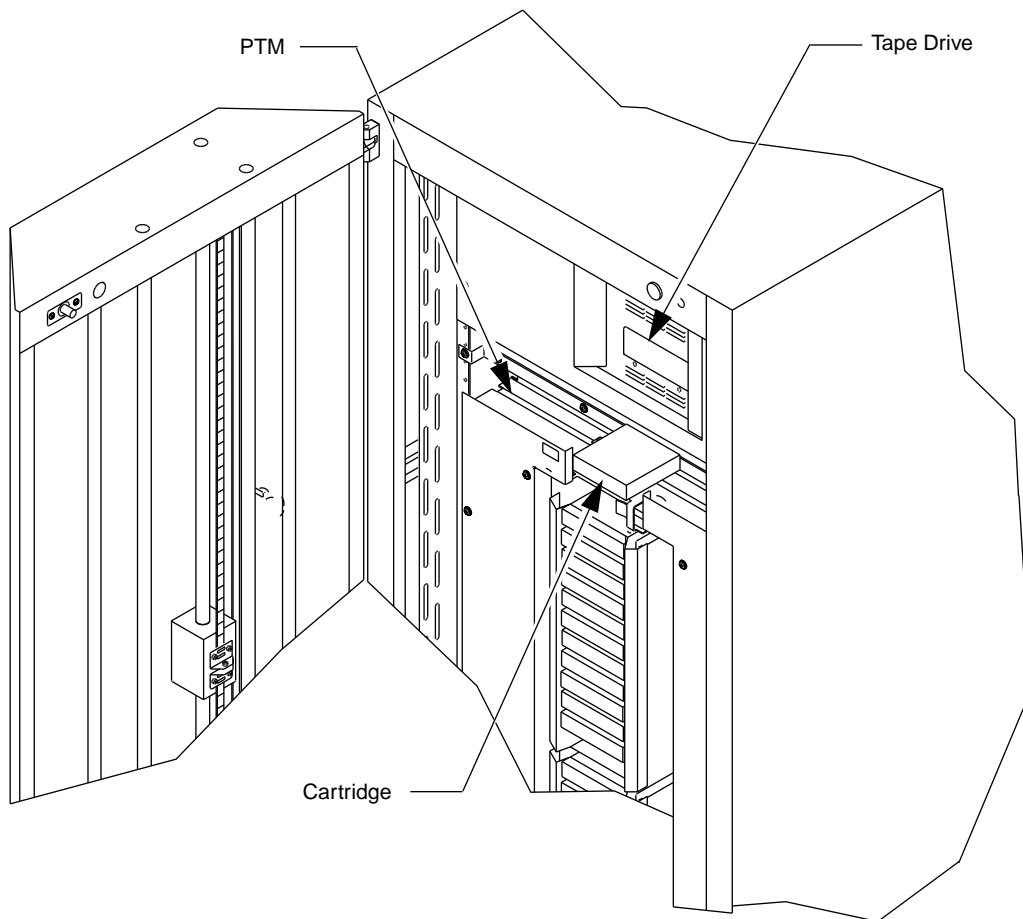

Inport/Output Device

Without interrupting operation, the inport/output device (IOD) allows you to load single cartridges and unload up to 12 cartridges.

The IOD is located on the front door hinge-side of the cabinet. In a multi-unit library configuration, the IOD is mounted on the left end unit.

Figure 9: IOD Location

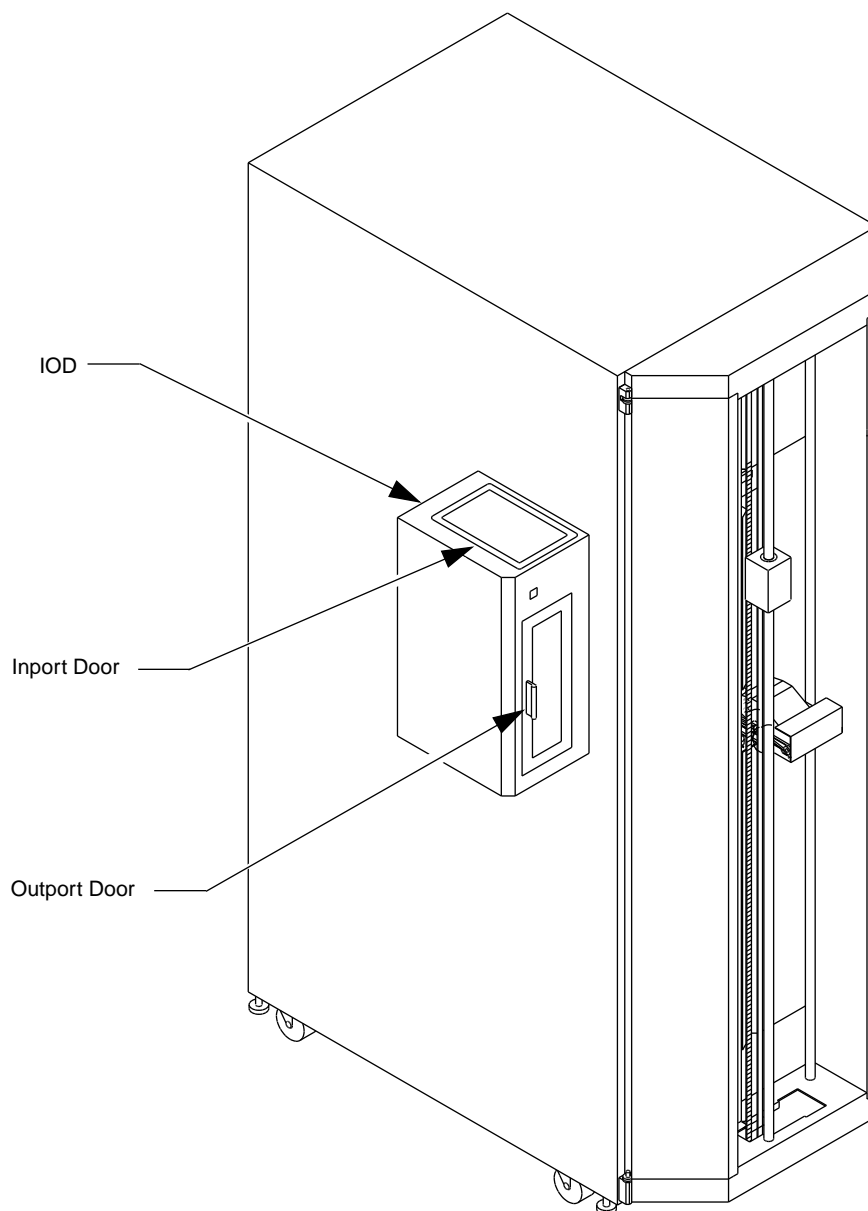

Cartridge/Tape Drive Compatibility

The TL82X library supports the TZ88N tape drive, and the CompacTape III™, CompacTape III™, and CompacTape IV™ cartridges, which are brown, dark gray, and black, respectively.



CAUTION *DO NOT USE* CompacTape I™ or CompacTape II™ **tape cartridges in your TL822 or TL826 library. Refer to Table 9 below for compatibility with other DLT™ cartridge formats.**

Table 9: Cartridge/Tape Drive Compatibility

Library	CompacTape I™	CompacTape II™	CompacTape III™	CompacTape III™ XT	CompacTape IV™
TL820	Read	Read	Read/Write	(not supported)	(not supported)
TL822	(not supported)	(not supported)	Read/Write	Read/Write	Read/Write
TL826	(not supported)	(not supported)	Read/Write	Read/Write	Read/Write

Operating Instructions **3**

Mounting and Removing Bin Packs	3-3
Mounting a Bin Pack on the Carousel	3-3
Inserting and Removing Bin Pack Cartridges	3-6
Loading and Unloading Cartridges via the IOD	3-8
Loading Cartridges into the IOD Inport Door	3-8
Unloading Cartridges from the IOD Outport Door	3-8
Manually Unloading the Tape Drive	3-10
Cleaning and Lubrication	3-12
Cleaning and Lubricating the Vertical Rails	3-12
Cleaning and Lubricating the Extension Rails	3-13

Mounting and Removing Bin Packs

Cartridges are stored in the TL82X library in bin packs that hold up to 11 cartridges each. Periodically, you may need to load and unload cartridge from the bin packs, as well as mount and remove the bin packs from the carousel.

Mounting a Bin Pack on the Carousel

When mounting bin packs, it is best to completely fill one face of the carousel from top to bottom, and then fill the next face (either to the right or left). Filling each face simplifies mounting, and minimizes carousel rotation when the gripper moves from one cartridge location to another.

To mount a bin pack on the carousel, do the following.

1. Place the library off-line, by pressing the STANDBY button. The STANDBY indicator lights and "01" displays.
2. Rotate the carousel by pressing the ← and → buttons until the desired carousel face is at the front.



WARNING

To prevent injury from moving components, always press the STOP button before opening the front door.

3. Open the front door.
4. Mount the bin pack on the carousel face as shown in Figure 10 on page 3-5. The mounting holes on the back of the bin pack are key-hole shaped so they will lock the bin pack into place when the narrow top part of the hole slides down over the mounting buttons.
5. Pull on the top and bottom of the bin pack to insure it is mounted properly on all four mounting buttons.
6. If not done already, load the bin pack with cartridges.
7. Run your hand down the front face of the cartridges on the exposed carousel face to make sure they are seated properly. (Do not run your hand up the front face of the cartridges since this can cause them to become seated incorrectly.)
8. Repeat the previous steps for any other bin packs that need to be mounted.
9. Close the front door.
10. Verify that the STOP button is released.

11. Place the library on-line by pressing the STANDBY button.

Once the front door is closed and the library is on-line, it will reinventory the following:

- the front face of the carousel.
- any other faces that were exposed while the door was open.
- the tape drives.
- the PTM if a cartridge is detected on the tray.

During inventory, "2d" appears in the status display. When the inventory is completed successfully, the status display reads "00". If any other code is displayed on the status display, see Chapter 4.

Figure 10: Mounting a Bin Pack on the Carousel

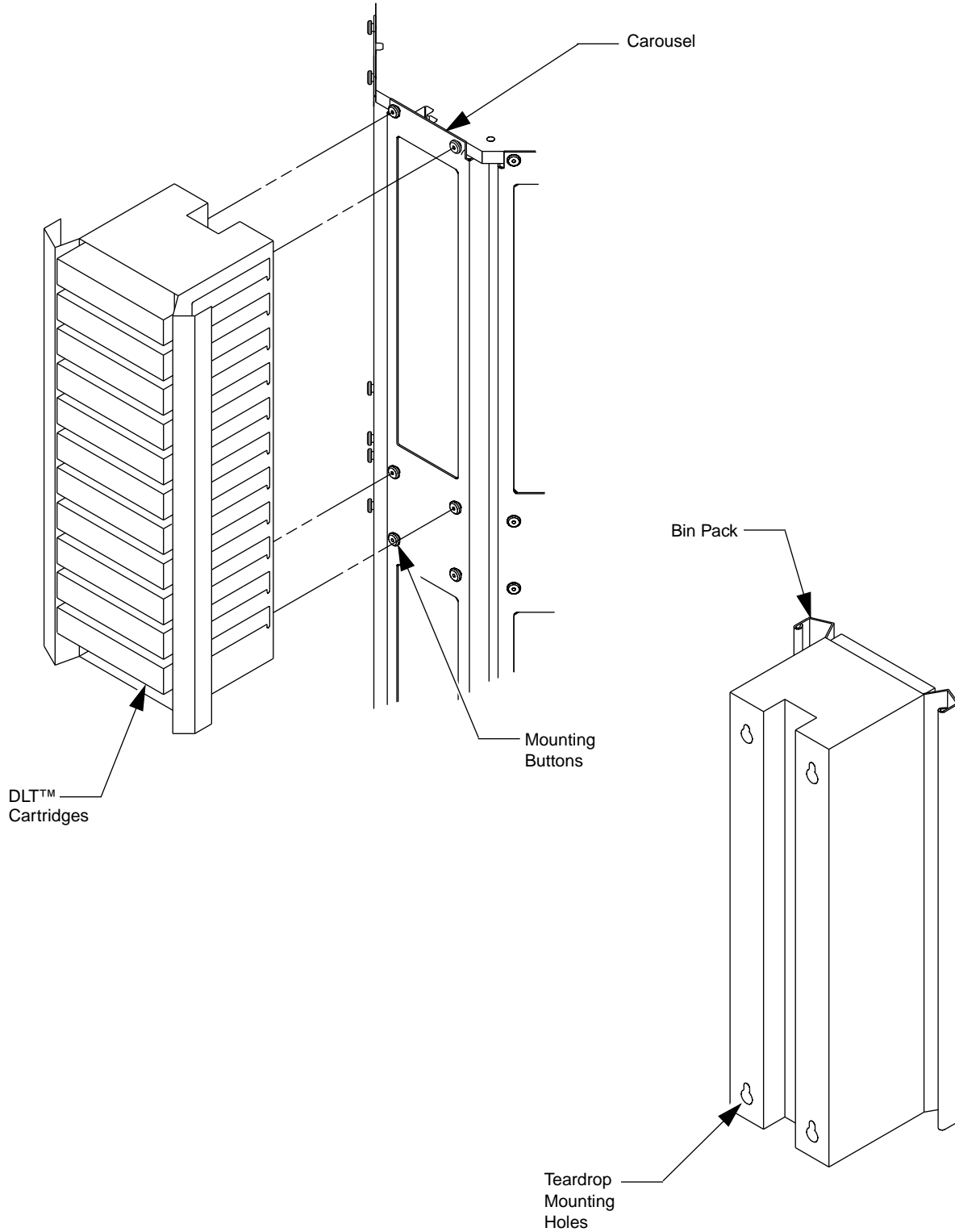

Inserting and Removing Bin Pack Cartridges

If needed, you can load individual cartridges into bin packs that are already mounted on the carousel.

 **CAUTION** ***DO NOT USE** CompacTape I™ or CompacTape II™ **tape cartridges in your TL822 or TL826 library. Refer to Table 9, “Cartridge/Tape Drive Compatibility,” on page 2-18 for compatibility with other DLT™ cartridge formats.***

 **CAUTION** ***Examine all cartridges before loading them into the library or tape drives. Look for label stock or other foreign material that may be clinging to them.***

Note ***Your facility may have its own requirements regarding the order of cartridges in bin packs. Refer to these requirements when loading cartridges.***

To load a cartridge into a bin pack that is already mounted on the carousel, do the following.

1. Place the library off-line by pressing the STANDBY button. The STANDBY indicator lights and “01” displays.
2. Rotate the carousel by pressing the ← and → buttons until the desired carousel face is at the front.

 **WARNING** ***To prevent injury from moving components, always press the STOP button before opening the front door.***

3. Open the front door.
4. Insert the cartridges into the bin pack with the bar code label slot facing out and the cartridge spindle facing down.

Note ***It is impossible to fully insert a cartridge into a bin pack incorrectly. You will notice if the cartridge does not fit into the cartridge slot, reorient it as described in step 4, and reinsert the cartridge.***

5. Run your hand down the front face of the cartridges on the exposed carousel face to make sure they are seated properly. (Do not run your hand up the front face of the cartridges since this can cause them to become seated incorrectly.)
6. Close the front door.
7. Verify that the STOP button is released.

8. Place the library on-line, by pressing the STANDBY button.

Once the front door is closed and the library is on-line, it will reinventory the following:

- the front face of the carousel.
- any other faces that were exposed while the door was open.
- the tape drives.
- the PTM if a cartridge is detected on the tray.

Loading and Unloading Cartridges via the IOD

You can also load and unload individual cartridges from the library without interrupting operation, by loading and unloading them through the IOD.

 **CAUTION** *DO NOT USE* CompacTape I™ or CompacTape II™ **tape cartridges in your TL822 or TL826 library. Refer to Table 9, “Cartridge/Tape Drive Compatibility,” on page 2-18 for compatibility with other DLT™ cartridge formats.**

 **CAUTION** *Examine all cartridges before loading them into the library or tape drives. Look for label stock or other foreign material that may be clinging to them.*

Loading Cartridges into the IOD Inport Door

To load a cartridge into the library via the IOD inport door, do the following.

1. Through the host, issue the command that enables the IOD inport door switch. After the switch is enabled, it will illuminate.
2. Press the switch to release the IOD inport door. The door will open to allow you to place the cartridge into the IOD.
3. With the bar code label facing you and the cartridge spindle facing downward, load the front end of the cartridge first, then gently push the back end down and into the inport.
4. Close the inport door.
5. When the host commands the library to load the cartridge, it transfers from the IOD through the PTM(s) and to the appropriate drive or bin.

Unloading Cartridges from the IOD Output Door

To unload cartridges from the IOD output door, do the following.

1. Make sure the PTM is not in the process of exporting a cartridge to the IOD.
2. Open the IOD output door by gently pulling the handle toward you.
3. Pull the cartridges out of the output section. The tray beneath the bottom cartridge will return to its topmost position to accept the next exported cartridge.

Figure 11: Loading an IOD

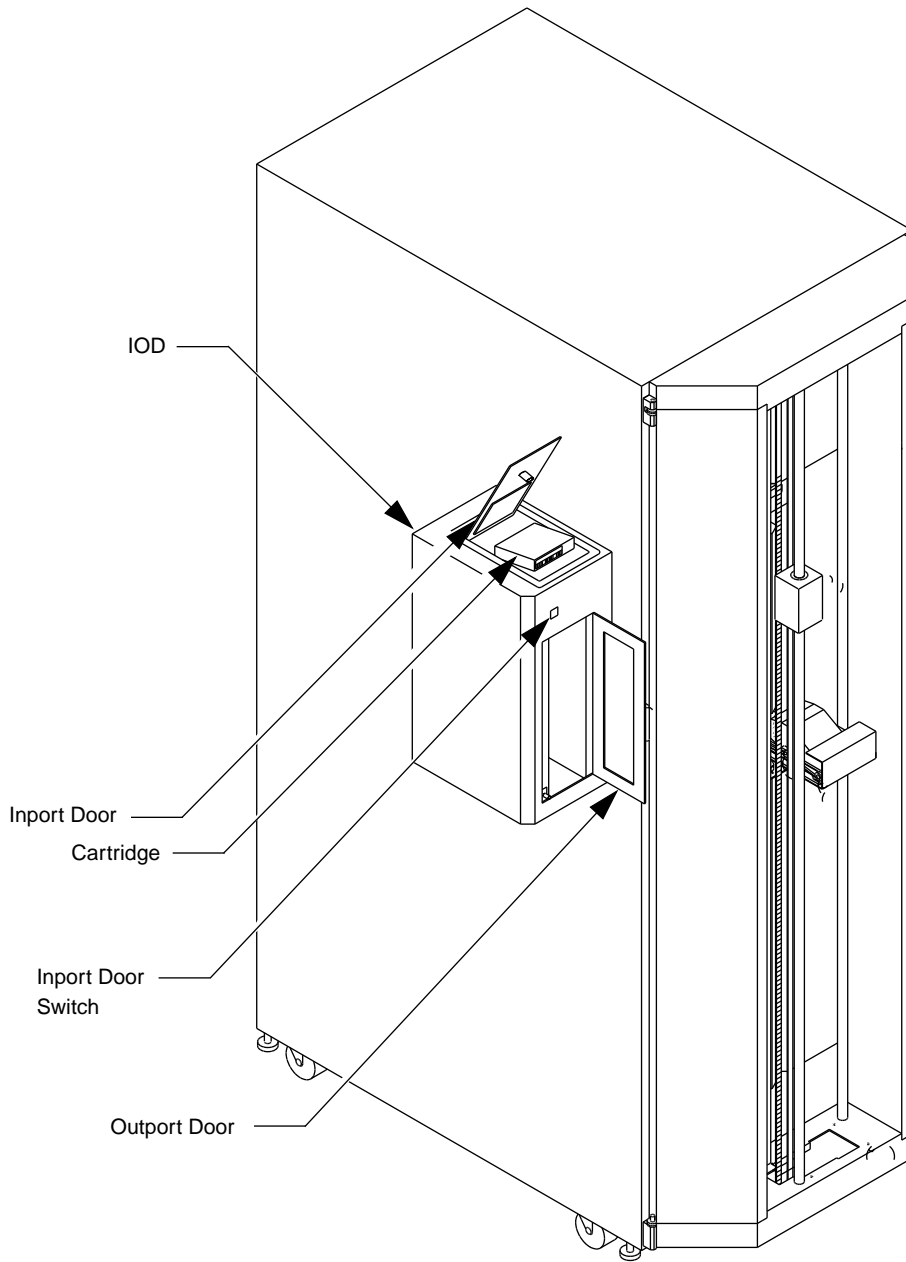

Manually Unloading the Tape Drive

When manually unloading cartridges from a TZ87 or TZ88N tape drive, there is a possibility that the take-up leader and the cartridge leader may fail to unbuckle. This condition may occur if the ejected cartridge is allowed to eject freely when the handle is opened and is caused by the cartridge ejecting too far and too fast. To ensure a successful unbuckle of the leaders, use the procedure below and Figure 12.

1. Press and release the control panel STANDBY switch and verify that:
 - the STANDBY indicator illuminates and
 - the status display reads "01" (standby).
2. Open the library front door.
3. On the tape drive status control panel, press and release the DRIVE UNLOAD switch of the drive to be unloaded and verify that the Operate Handle indicator is lit.

Note *When you press DRIVE UNLOAD, the tape will completely rewind. Depending on the tape position, it will take 10 to 120 seconds before the Operate Handle indicator lights.*

4. Place a finger approximately 1/4" in front of the drive mouth of the drive to be unloaded and with the Operate Handle indicator lit, raise the insert/release handle to eject the DLT cartridge.

 **CAUTION** *If the cartridge leader is buckled to the take-up leader, push the cartridge all of the way back into the drive mouth and return to Step #3. Otherwise, continue to Step #5.*

5. Pause for two seconds, then pull the cartridge completely out of the drive.
6. Close and latch the library front door.
7. Press and release the control panel STANDBY switch and verify that the status display reads "2d" (system initializing/taking inventory).
8. After successful initialization and inventory, verify that the status display reads "00" (on-line).

Figure 12: Tape Drive
Status Control Panel

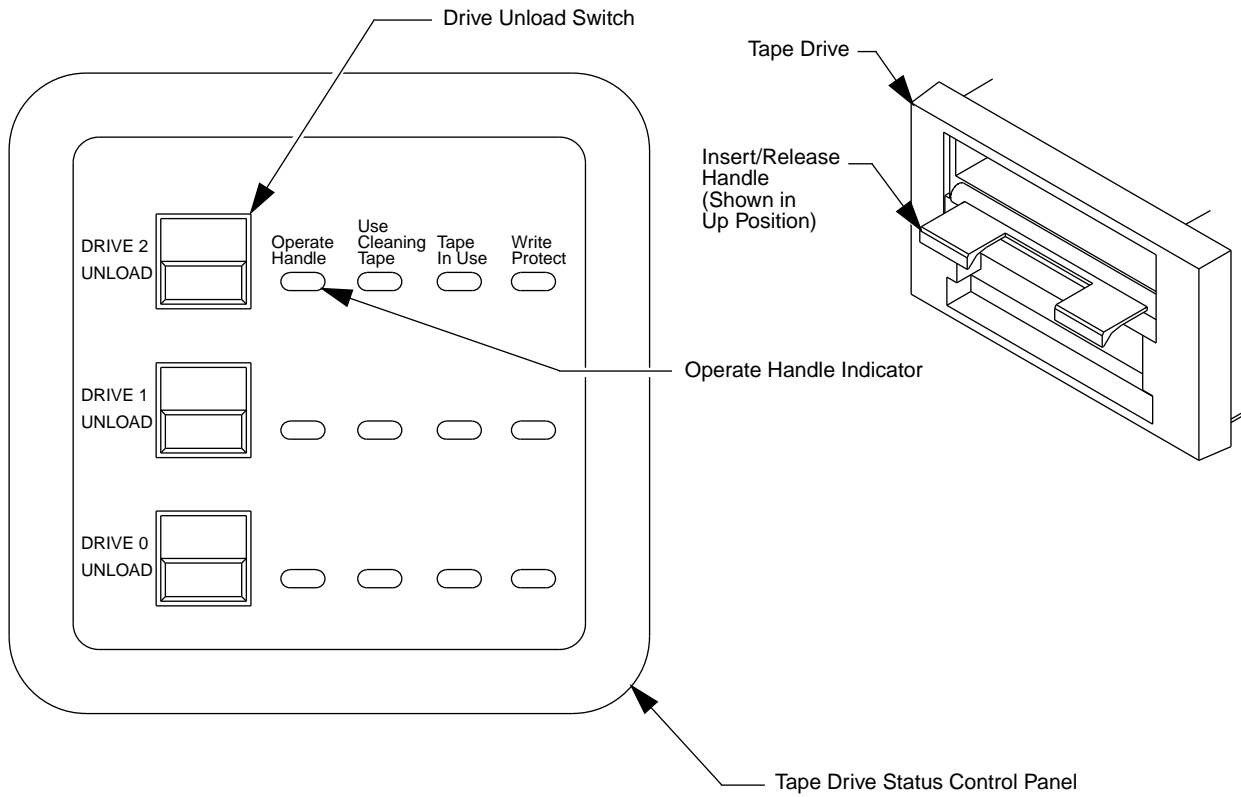

Cleaning and Lubrication

It is recommended that you clean and lubricate the vertical axis rails, extension axis rails and gripper every 90 days. The cleaning and lubrication accessories kit shipped with your library includes the following supplies:

- (1) container of light grease
- 25 swabs
- 10 lint free cloths

Cleaning and Lubricating the Vertical Rails

1. Remove power from the library by turning off the circuit breaker switch, which is located on the lower left corner of the rear connector panel.
2. Open the front door of the library.
3. Using a lint free cloth and isopropyl alcohol, clean all three of the vertical rails removing all dust and debris.
4. Using a second lint free cloth and light grease, lightly lubricate each of the vertical rails by rubbing the cloth up and down the entire length of the rail.
5. Manually move the vertical carriage up and down the vertical rails to completely distribute the applied lubricant, while checking for smooth vertical travel.

Cleaning and Lubricating the Extension Rails

1. Remove power from the library by turning off the circuit breaker switch, which is located on the lower left corner of the rear connector panel.
2. Open the front door of the library.
3. Using a lint free cloth and isopropyl alcohol, clean the extension rail on the extension axis assembly.

Note *Gently move the gripper assembly forward and back on the rail to gain access to the entire length of the rails for cleaning.*

4. Using a second lint free cloth and light grease, lightly lubricate the entire length of both extension rails by rubbing the lubricated cloth forward and back on the rails.
5. Manually move the gripper assembly forward and back on the rails to completely distribute the applied lubricant, while checking for smooth extension travel.

Troubleshooting

4

Error Messages sent to the Host	4-3
Status Codes	4-4
Other Problems.	4-8



Error Messages sent to the Host

When an error condition occurs on the TL82X library, error codes are sent from the library unit to the host. Refer to the documentation for the host software for a description of how these error codes are received and processed.

Status Codes

Table 10 lists status display codes and what steps you should to take to resolve any problems associated with them.

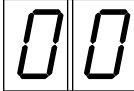
Table 10: Status Codes

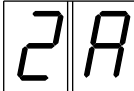
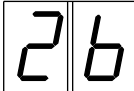
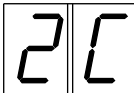
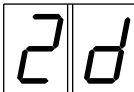
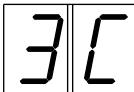
Code	Code Description	Action to Resolve
	System is on-line and ready to accept host commands.	No action is needed.
	System is off-line and ready to accept diagnostic commands.	Release the STANDBY button by pressing it once. This places the library on-line.
	STOP button is pressed.	Release the STOP button by pressing it once.
	Either the front door is open or the rear panel is removed	Check the front door and rear panel.
	System is performing a power-up sequence.	This code should only be displayed for 5-10 seconds during the power-up sequence. If it continues to display, call for field service.
	System is initializing actuators and taking inventory.	If this code persists and the robotic equipment inside the library unit does not move, call for field service.
	Inventory failed.	<ol style="list-style-type: none"> 1) Press the STANDBY button to put the library off-line. 2) Release the STANDBY button to put the library back on-line. 3) If the code still persists, ask the system administrator to refer to the error codes from the library to the host, which will indicate the cause of the failure.

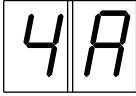
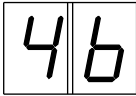
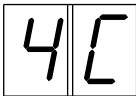
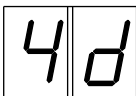
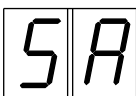
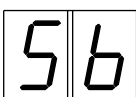
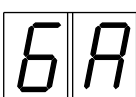
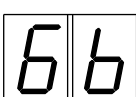
Code	Code Description	Action to Resolve
	Extension home failed.	<ol style="list-style-type: none">1) Press the STANDBY button to put the library off-line.2) Release the STANDBY button to put the library back on-line.3) If the code still persists, call for field service.
	Extension test failed.	<ol style="list-style-type: none">1) Press the STANDBY button to put the library off-line.2) Release the STANDBY button to put the library back on-line.3) If the code still persists, call for field service.
	Carriage A/D failed.	<ol style="list-style-type: none">1) Press the STANDBY button to put the library off-line.2) Release the STANDBY button to put the library back on-line.3) If the code still persists, call for field service.
	Carriage diagnostic test failed.	<ol style="list-style-type: none">1) Press the STANDBY button to put the library off-line.2) Release the STANDBY button to put the library back on-line.3) If the code still persists, call for field service.
	Vertical home failed.	<ol style="list-style-type: none">1) Press the STANDBY button to put the library off-line.2) Release the STANDBY button to put the library back on-line.3) If the code still persists, call for field service.
	Vertical test failed.	<ol style="list-style-type: none">1) Press the STANDBY button to put the library off-line.2) Release the STANDBY button to put the library back on-line.3) If the code still persists, call for field service.
	Carousel home failed.	<ol style="list-style-type: none">1) Press the STANDBY button to put the library off-line.2) Release the STANDBY button to put the library back on-line.3) If the code still persists, call for field service.
	Carousel test failed.	<ol style="list-style-type: none">1) Press the STANDBY button to put the library off-line.2) Release the STANDBY button to put the library back on-line.3) If the code still persists, call for field service.

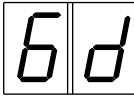
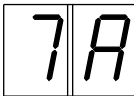
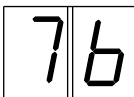
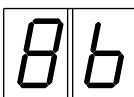
Code	Code Description	Action to Resolve
	Carousel A/D test failed.	<ol style="list-style-type: none">1) Press the STANDBY button to put the library off-line.2) Release the STANDBY button to put the library back on-line.3) If the code still persists, call for field service.
	Carousel digital test failed.	<ol style="list-style-type: none">1) Press the STANDBY button to put the library off-line.2) Release the STANDBY button to put the library back on-line.3) If the code still persists, call for field service.
	Gripper home failed.	<ol style="list-style-type: none">1) Press the STANDBY button to put the library off-line.2) Release the STANDBY button to put the library back on-line.3) If the code still persists, call for field service.
	Gripper test failed.	<ol style="list-style-type: none">1) Press the STANDBY button to put the library off-line.2) Release the STANDBY button to put the library back on-line.3) If the code still persists, call for field service.
	Light curtain test failed.	<ol style="list-style-type: none">1) Press the STANDBY button to put the library off-line and open the front door.2) Remove/replace any objects that may be in the way of the light beam, such as a tape partially ejected from a tape drive or a cartridge not properly seated in a bin pack. Close the front door.3) Release the STANDBY button to put the library back on-line.4) If the code still persists, call for field service.

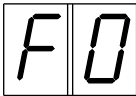
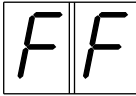
Code	Code Description	Action to Resolve
	Light curtain broken.	<ol style="list-style-type: none">1) Press the STANDBY button to put the library off-line and open the front door.2) Remove/replace any objects that may be in the way of the light beam, such as a tape partially ejected from a tape drive or a cartridge not properly seated in a bin pack. Close the front door.3) Release the STANDBY button to put the library back on-line.4) If the code still persists, call for field service.
	Carousel is on face indicated (0-7).	These codes are only displayed for a few seconds when you press the ← and → to move the carousel. No action is needed.
	MPU failure	Call Field Service

Other Problems

In addition to problems described in the previous section, there are other problems that can occur. Table 11 lists some of these problems and the steps to take to resolve them.

Note *Resolution of all problems should be coordinated through the system administrator.*

Table 11: Common
TL82X Problems

Problem	Resolution
Tape cartridge is not loading or ejecting properly from the tape drive.	<ol style="list-style-type: none">1) Press the STANDBY button to put the library off-line.2) Open the front door, and manually insert or eject the cartridge using the controls on the tape drive. DO NOT manually put a cartridge into the gripper.3) Close the door and release the STANDBY button to put the library back on-line.4) If the problem recurs, refer to the tape drive manual or call for tape drive service.
One or more cables have become disconnected from the rear connector panel.	<ol style="list-style-type: none">1) Press the STANDBY button to put the library off-line.2) Reconnect the cables. (See Chapter 2.)3) Close the door and release the STANDBY button to put the library back on-line.
Bar code scanner laser remains on when door is open.	Contact your field service engineer.
The PTM stops before the cartridges reach the center PTM opening, the IOD, or another PTM.	<ol style="list-style-type: none">1) Press the STANDBY button to put the library off-line.2) Open the front door, and manually push (with your index finger) the cartridge along the PTM to the center PTM opening or the IOD. If you move the cartridge to the center of the PTM, the PTM will be inventoried when the door is closed.3) Close the door and release the STANDBY button to put the library back on-line.4) If the problem reoccurs, contact your field service engineer.

Note *For any other problems not listed here or in the previous section, call for field service.*

Glossary

TL820 library	An automated library system developed for storing and handling DLT™ cartridges. Contains three TZ87 DLT™ tape drives and a maximum of 264 cartridges.
TL822 library	An automated library system developed for storing and handling DLT cartridges. Contains three TZ88N DLT™ tape drives and a maximum of 264 cartridges.
TL826 library	An automated library system developed for storing and handling DLT™ cartridges. Contains six TZ88B DLT™ tape drives and a maximum of 176 cartridges.
alignment	In the context of this manual, alignment refers to the mechanical adjustments required for successful operation of the TL82X library.
alignment toolkit	A set of alignment aids available to authorized field service personnel.
auto-clean	<p>This term refers to the Automatic Drive Cleaning feature. Two modes of drive cleaning support are available on library units with a Model Number of 6200213: Host Initiated and Fully Automatic.</p> <p>In Host Initiated Cleaning Mode, drive cleaning is enabled by your System Administrator at the host computer. Although the library unit will internally track cleaning cartridge movement and use, the library unit provides no cleaning support in this mode. The host is responsible for all cleaning functions such as detecting when a drive requires cleaning, tracking and selecting cleaning cartridges, initiating media movement of the cleaning cartridge to the drive and determining when a cleaning cartridge has been “used up.”</p> <p>Drive cleaning in the Fully Automatic Cleaning Mode is also enabled by your System Administrator at the host computer. However, in this mode, the library unit monitors each drive's status to determine when a drive requires cleaning and initiates action when that determination is made. In this case, the library unit selects an available cleaning cartridge, handles media movement of the cleaning cartridge to and from the drive and supervises the cleaning operation in the drive. The library unit tracks cleaning cartridges within the library, monitors cleaning</p>

cartridge use and determines when a cleaning cartridge has been “used up.” A “used up” cleaning cartridge is exported from the library under control of the library.

Note *The library is shipped with Automatic Drive Cleaning disabled. The Automatic Drive Cleaning feature can be enabled using the Diagnostic Software Package. However, when the library power is cycled, the feature is disabled. If the Automatic Drive Cleaning feature is enabled from the Host Controller via the Mode Select command, then the feature will remain enabled even if power is cycled.*

automated cartridge library	A robotic storage and retrieval system for cartridges.
bar code	In the context of this manual, the machine-readable label on DLT cartridges.
bar code scan head	The portion of the bar code scanner which senses the bar code and is mounted on the vertical carriage.
bin pack	A removable rack that stores up to eleven DLT™ cartridges inside the tape library. It attaches to the carousel inside a TL82X library.
calibration	In the context of this manual, calibration refers to the software measurements and configuration required for successful operation of the library.
carousel	The eight-sided rotating prism in the center of the library which holds bin packs with DLT cartridges.
carousel belt	The drive belt connecting the carousel motor/gearbox to the carousel.
carousel face	One side of the eight-sided carousel.
control panel	The panel containing the display, fault light, and control buttons on the front door of the library.
door interconnect board	The electronics board located on the front door to which the cables crossing the hinge are connected.
EIA/TIA-574	A serial communications cabling and protocol standard for nine-pin connectors, sometimes referred to as RS-232.
electronics module	The metal enclosure holding the logic power supply and the robotic control and actuator driver electronics.
extension axis assembly	Mounted onto the vertical axis, the extension axis assembly consists of the gripper assembly and the horizontal axis on which the gripper assembly is mounted.

extension axis belt	The drive belt connecting the extension motor/gearbox to the gripper.
FCC Class A	Standard established by the U.S. Federal Communications Commission governing electromagnetic emissions.
FSE	Field Service Engineer, a.k.a., FE (Field Engineer).
gripper assembly	The assembly which mounts on the extension axis and grips cartridges; sometimes called the gripper.
host	Host computer.
host computer	The computer which issues high-level pick and place commands to control the TL82X library.
IOD	The Inport/Outport Device, located at the cutout on the left side of the TL82X library, allows insertion and removal of single cartridges into and out of the library.
LED	Light Emitting Diode.
library	A single TL82X cabinet and the robotics therein.
mounting kit	Kits supplied with TL82X libraries for installing tape drive systems in the unit.
MTBF	Mean Time Between Failures.
MTTR	Mean Time To Repair.
MUC	The Multi-Unit Controller serves two functions. It is a SCSI adapter and it permits the library host computer to control up to five attached basic or expansion TL82X libraries.
on-line	Ready for communication with a host computer.
PC	Personal Computer.
pick	The act of removing a cartridge from one location in preparation for placing it in another location.
place	The act of placing a cartridge in a location after it has been picked from another location.
power distribution box	A box located in the left rear of the TL82X/TL82X cabinet which contains receptacles for providing power to the various components of the library and switches for turning the power on and off.
PTM	The Pass-Through Conveyor Mechanism is the motor-driven, high-speed conveyor that transports cartridges between adjacent libraries in a multi-unit TL82X tape library. It is used in

	conjunction with the IOD when importing or exporting single cartridges.
PROM	Programmable Read-Only Memory.
rear connector panel	Located at the bottom rear of the cabinet, the rear connector panel contains the connectors for attaching external cabling to the library.
SCSI	Small Computer System Interface communications standard for attaching peripheral equipment to computers.
tape drive	The mechanism that reads and writes data from and to a tape.
tape drive alignment cartridge	An alignment aid in the general form of a DLT cartridge which has flanges to keep it from being stuck in a drive.
UL	Underwriters Laboratories.
vertical belt	The drive belt connecting the vertical motor to the vertical axis assembly.
vertical carriage assembly	The crossbar and linear bearings mounted onto the vertical rails and everything mounted on the crossbar.
ZIF connector	A Zero Insertion Force connector used for electrical wiring.

Index

A

auto-clean G-1

B

bar code scanner, troubleshooting 4-8

bin packs 2-3

 inserting cartridges into 3-6

 loading cartridges via 3-3

 mounting on carousel 3-3-3-5

 removing 3-3

 removing cartridges from 3-6

C

carousel

 rotating 2-7, 3-3, 4-7

 status code 4-5

carriage A/D status code 4-5

cartridges

 inserting into bin packs 3-6

 loading via IOD 3-8

 location 2-5

 removing from bin packs 3-6

 unloading via IOD 3-8

cleaning and lubricating 3-12-3-13

 extension rails 3-13

 vertical rails 3-12

control panel

 front 2-6-2-7

 status codes 4-4-4-7

 tape drive status 2-8-2-9

conventions 1-4

D

documentation, reference 1-4

door handle 2-10

 location 2-5

drive unload button 2-9

E

error messages sent to host 4-3

extension axis

 cleaning and lubricating rails 3-13

 status code 4-5

F

FAULT indicator 2-7

front control panel 2-6-2-7

 location 2-5

fully automatic cleaning mode G-1

G

gripper 2-3

 location 2-5

 status code 4-6

H

host initiated cleaning mode G-1

I

initialize actuators status code 4-4

inport/output device 2-3, 2-17

 loading cartridges into 3-8

 location 2-17

 unloading cartridges from 3-8

inventory status code 4-4

L

left arrow button 2-7

light curtain status code 4-6

lubrication 3-12-3-13

M

multi-unit controller 2-3, 2-11

O

operate handle indicator 2-9

P

pass-through conveyor mechanism 2-3, 2-16
 location 2-16
 troubleshooting 4-8
power-up sequence 4-4

R

rear connector panel 2-11
 cabling 4-8
related documentation 1-4
right arrow button 2-7

S

safety switch 2-10
 location 2-5
STANDBY button 2-7
STANDBY indicator 2-7
status codes 4-4-4-7
 when mounting bin packs 3-4
status display 2-7
STOP button 2-7

T

tape drive status control panel 2-8-2-9
tape drives
 location 2-5
 troubleshooting 4-8
tape in use indicator 2-9

U

use cleaning tape indicator 2-9

V

vertical axis

cleaning and lubricating rails 3-12
status code 4-5

W

write protect indicator 2-9