

# PC Server and Workstation Cabling Guidelines

**NOTE**

This application note only pertains to 8-bit SCSI devices.

The inter-device cabling of StorageWorks products is critical to the proper operation of the system. All the devices used in a StorageWorks system are SCSI-2 compliant and the cabling must meet the requirements set forth in the ANSI Small Computer System Interface specification.

The host adapters that are currently available can have either a low-density or a high-density external connector. Figure 1 shows the connectors for 50-pin low-density and high-density cables.

**Figure 1 50-pin SCSI Connectors**

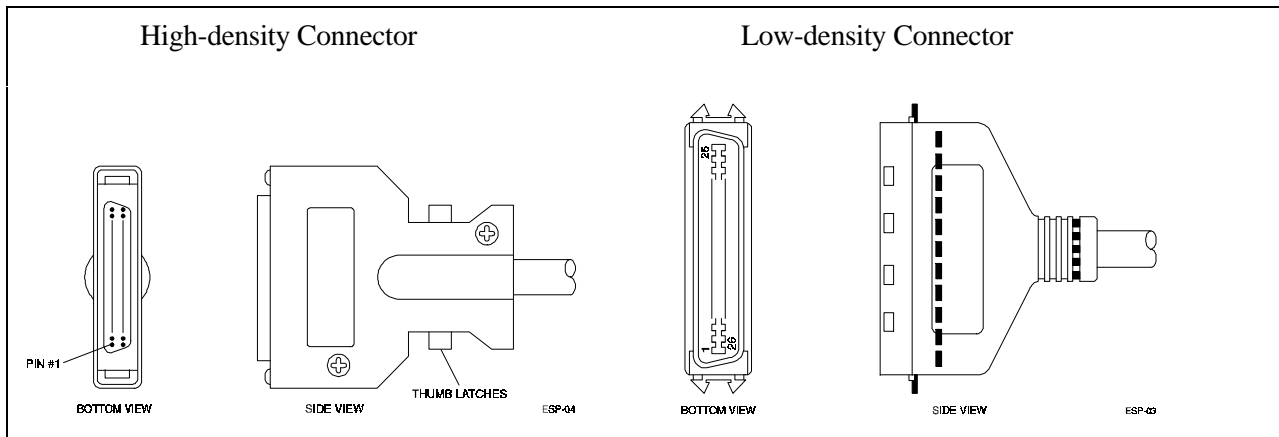

In order to select the proper cable for your host adapter, you must first determine which connector is on your adapter. Look at the connector on your adapter and compare it with the above drawings to determine the cable connector that is required on the adapter end of the cable. Refer to Table 2 for the connector required on the peripheral end of the cable.

Table 1 provides information about some of the current adapters.

**Table 1. Sample Adapter Connector information**

Adapter	Low Density Connector(s)	High Density Connector(s)
Adaptec	1540, 1540C, 1542	1740, 1742, 2740
BusLogic		BT545S, BT747S
DPT	PM 2021	PM2022, PM2122

**CABLING RULES:****NOTE**

The total length of the cabling for a specific installation, including external cables and internal wiring, should be as short as possible.

- A slow, narrow, single-ended SCSI bus, including internal wiring and external cabling, can have a maximum length of 6 meters.
- A fast, narrow, single-ended SCSI bus, including internal wiring and external cabling, can have a maximum length of 3 meters.
- If any device on the SCSI bus is a fast, narrow device, the maximum cable length, including internal wiring and external cabling, is 3 meters.
- The SWXSE-02 Expansion Storage Pedestal and the SWXSE-03 Desktop Expansion Unit have an internal wiring length of 0.9 meters with a terminator and 1.0 meters without a terminator in place.

**Table 2 StorageWorks Device Connectors**

Device	Connector Density	SCSI Bus Type
SWXSE-02 Expansion Storage Pedestal	High	Fast
SWXSE-03 Desktop Expansion Unit	High	Fast
SWXTL-BT Tabletop Tape Drive	Low	Slow

Disk drives are fast SCSI devices while tape drives and CD-ROM require a slow SCSI bus.

**Cables available for use with StorageWorks products**

1. 50-pin SCSI host adapter-to-device (or device to device) cables that are available, their length, and density are shown below

CABLE PART NUMBER	LENGTH (METERS)	DENSITY (50-pin) H=High, L=Low
BN21H-0C <sup>1</sup>	0.3	H/H
BN21H-0E <sup>1</sup>	0.5	H/H
BN21H-01 <sup>1</sup>	1.0	H/H
BN21H-1E <sup>1</sup>	1.5	H/H
BN21H-02 <sup>1</sup>	2.0	H/H
BN21H-03 <sup>1</sup>	3.0	H/H
BN23G-01	1.0	H/L
BN23G-02	2.0	H/L
BC19J-03	1.0	L/L
BC19J-06	2.0	L/L

1. Fast, narrow, single-ended SCSI buses can have a maximum length of 3.3 meters when these cable are used exclusively.

2. 68-pin RAID Array 110 interface cables that are available, their length, and density are shown below (these cables are used with the Y-cable supplied with the host adapter):

CABLE PART NUMBER	LENGTH (METERS)	DENSITY (68-pin) H=High, L=Low
BN21K-05	5.0	H/H
BN21K-10	10.0	H/H

**Typical StorageWorks Configurations**

These configurations are presented for use as guidelines in determining the cables that are required to successfully install a StorageWorks system. Detailed installation information is contained in the User's Guides for the Desktop Expansion Unit (EK-SMCPG-UG) and the Expansion Storage Pedestal (EK-SMCPA-UG).

**NOTE**

To minimize cable lengths, connections to the Expansion Storage Pedestal (SWXSE-02) can be made through the knockout panels located on the four corners of the pedestal's side panels.

In these configurations, the storage devices called out in the artwork are:

- |                      |   |
|----------------------|---|
| Expansion Pedestal   | SWXSE-02 Expansion Storage Pedestal       |
| Desktop Expansion    | SWXSE-03 Desktop Expansion Unit           |
| TableTop Tape Drive  | SWXTL-BT Tabletop Tape Drive              |
| TableTop Tape Loader | SWXTL-BL TableTop 5-Cartridge Tape Loader |

**Host Computer/Server and One Expansion Storage Pedestal**

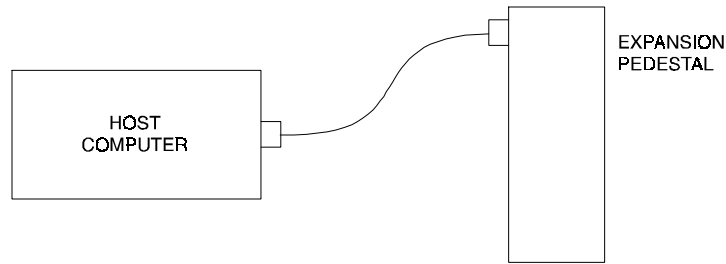

**Cabling**

	<u>H/L</u>	<u>H/H</u>
Host Computer to Expansion Pedestal	BN23G-01	BN21H-01
	or	or
	BN23G-02	BN21H-1E

## Host Computer/Server and Two Expansion Storage Pedestals

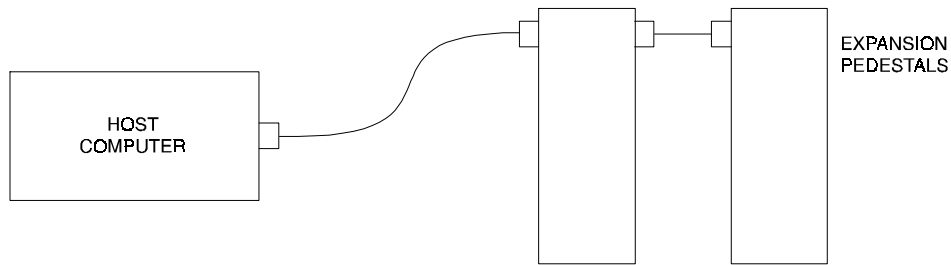

APPNOTE1-02

### Cabling

	<u>H/L</u>	<u>H/H</u>
Host Computer to Expansion Pedestal	BN23G-01	BN21H-01
Pedestal to Pedestal	BN21H-0E	BN21H-0E

### NOTE

The second pedestal must have a split bus and the cables must be routed through knockout panels in order to conform to SCSI cable length limitations. A split bus configures the pedestal into two SCSI buses: one a 3-device bus and the other a 4-device bus.

5.25-inch SBBs require 2 or more slots in the pedestal. If you have any 5.25 inch devices in your configuration, it is recommended that they be placed in the split bus pedestal. (For more information refer to *Reconfiguring the Pedestal for Two SCSI Buses* in the Expansion Storage Pedestal User's Guide, Order Number EK-SMCPB-UG.)

## Host Computer/Server and one Expansion Storage Pedestal and one Desktop Expansion Unit

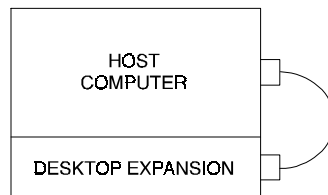

APPNOTE1-03

### Cabling

	<u>L/H</u>	<u>H/H</u>
Host Computer to Desktop Expansion	BN23G-01	BN21H-0C or 01, 1E, or 02

**Host Computer/Server with one Desktop Expansion and one Tabletop Tape Drive**

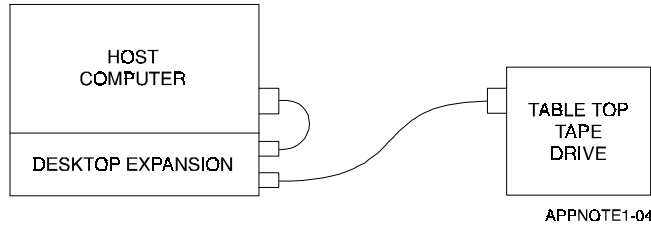

**Cabling**

	<u>L/H</u>	<u>H/H</u>
Host Computer to Desktop Expansion	BN23G-01	BN21H-0E
Desktop Expansion to Tabletop Tape Drive	BN23G-01	

**Host Computer/Server with one Table Top Tape Drive**

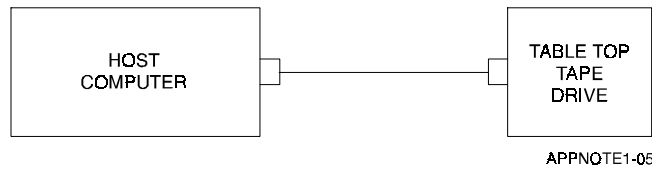

**Cabling**

	<u>L/L</u>	<u>L/H</u>
Host Computer to Tabletop Tape Drive	BC19J-03	BN23G-01
	or	or
	BC19J-06	BN23G-02

**Host Computer/Server with one Expansion Pedestal and one Tabletop Tape Drive**

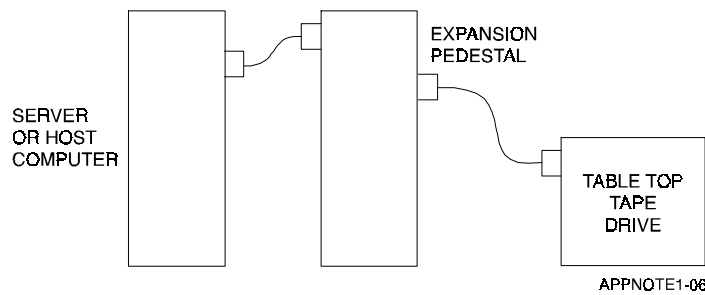

**Cabling**

	<u>L/H</u>	<u>H/H</u>
Host Computer/Server to Expansion Pedestal	BN23G-01	BN21H-01
Expansion Pedestal to Tabletop Tape Drive	B23G-01	

### Host Computer/Server with one Desktop Expansion and one Expansion Pedestal

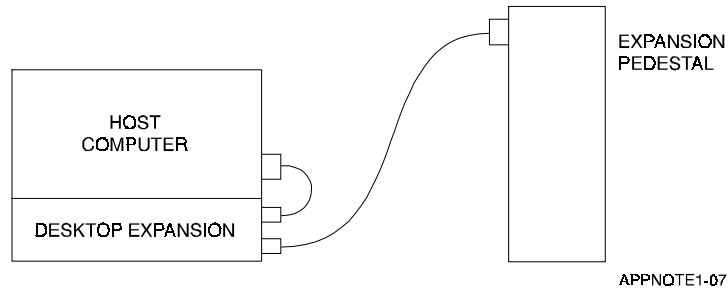

#### Cabling

Host Computer to Desktop Expansion	<u>L/H</u> BN23G-01	<u>H/H</u> BN21H-0C or 0E, 01
Desktop Expansion to Expansion Pedestal		BN21H-01