

*StorageWorks*TM Solutions

Enterprise Storage Array for I/O Intensive Applications

User's Guide

Order Number: EK-ESAT4-UG. B01

This manual describes the concepts and procedures necessary to install, configure, and use the Enterprise Storage Array on multiple operating systems. It also describes the major components of the Enterprise Storage Array.

November 1996

While Digital believes the information included in this publication is correct as of the date of publication, it is subject to change without notice.

Digital Equipment Corporation makes no representations that the interconnection of its products in the manner described in this document will not infringe existing or future patent rights, nor do the descriptions contained in this document imply the granting of licenses to make, use, or sell equipment or software in accordance with the description.

Note

This equipment generates, uses, and may emit radio frequency energy. The equipment has been type tested and found to comply with the limits for a Class A digital device pursuant to Part 15 of the FCC rules. These limits are designed to provide reasonable protection against harmful interference in a residential installation.

Any changes or modifications made to this equipment may void the users authority to operate this equipment.

Operation of this equipment in a residential area may cause interference in which case the user at his own expense will be required to take whatever measures will be required to correct the interference.

© Digital Equipment Corporation, 1996.

All Rights Reserved.

Printed in USA

Alpha AXP, DEC, HSZ, Digital, StorageWorks, and the DIGITAL logo are trademarks of Digital Equipment Corporation, Windows NT® and Windows 95® are registered trademarks of Microsoft Corporation.

Table of Contents

PREFACE

CHAPTER 1 OVERVIEW OF THE ENTERPRISE STORAGE ARRAY

1.1 Introduction	1-1
1.2 Prerequisites	1-1
1.3 Major Components	1-2
1.3.1 Cabinet	1-2
1.3.2 SBB Shelves	1-3
1.3.3 StorageWorks Building Blocks	1-3
1.3.4 Cable Distribution Unit	1-3
1.3.5 Array Controller Shelves	1-3
1.3.6 Array Controller	1-3
1.3.7 Array Controller Software	1-4
1.3.8 Fan Trays	1-4
1.3.9 StorageWorks Command Console Software	1-4

CHAPTER 2 SBB DEVICE OPERATION

2.1 The SBB Shelf	2-1
2.2 Power Supply Fault Notification	2-5
2.3 Storage Device Fault Notification	2-6
2.4 I/O Module Fault Notification	2-8
2.4.1 Data Bus Connections	2-10
2.4.2 Bus Termination	2-10
2.5 SBB ECB Shelf Fault Notification	2-11

CHAPTER 3 CONTROLLER OPERATIONS

3.1 Controller Mounting	3-1
3.2 The Controller Operating Software (HSOF)	3-2

CHAPTER 4 ESA CONFIGURATION

4.1 Redundant Power Configuration	4-1
4.2 Controller/Drive Configuration	4-3

CHAPTER 5 PREPARING YOUR HOST SYSTEM TO OPERATE WITH ESA

5.1 Applying Power to the ESA Cabinet	5-1
5.2 Logical Unit Number Requirement	5-2
5.3 Connecting SCSI Cables to the Controllers	5-2
5.4 Procedures for Your Operating System	5-3
5.5 Preparing Your Digital UNIX System for ESA	5-4
5.5.1 Installing the Host Adapter	5-4
5.5.2 Basic Configuration Steps	5-4
5.5.3 Installing the StorageWorks RAID Utility for Digital UNIX V3.2x	5-5
5.5.4 Rebuilding the Kernel for Digital UNIX V4.0	5-7
5.6 Preparing Your HP-UX System for ESA	5-8
5.6.1 Installing the Host Adapter	5-8

5.6.2 Installing the Host Device Driver	5-8
5.6.3 Verify Host Adapter and Driver	5-9
5.6.4 HP-UX Series 800 Patch Installation (10.01 only)	5-10
5.6.5 Set the SCSI Bus Address of the Array Controller	5-10
5.6.6 Reboot the System and Verify Successful Installation	5-11
5.7 Preparing Your IBM System for ESA	5-12
5.7.1 Organizing Your System	5-12
5.7.2 Installing the StorageWorks Software onto the Hard Disk	5-14
5.8 Preparing Your Solaris System for ESA	5-20
5.8.1 Installing DECptisp onto the Hard Disk	5-20
5.9 Preparing Your Windows NT/Alpha System for ESA	5-22
5.10 Preparing Your Windows NT/Intel System for ESA	5-23

CHAPTER 6 INSTALLING STORAGEWORKS COMMAND CONSOLE

6.1 Major Features	6-1
6.2 Program Modules	6-2
6.3 RAID Support and Terminology	6-2
6.4 Client System Requirements	6-3
6.5 Installing the SWCC	6-4
6.6 Agent Connection Licensing	6-4
6.6.1 Installing Additional Agents	6-5
6.7 Next Steps	6-5

GLOSSARY

Preface

This document presents the concepts and procedures necessary to install, configure, and use the StorageWorks™ Enterprise Storage Array on multiple operating systems. The major components of ESA are also described.

Detailed information on all aspects of the ESA and major components can be found in referenced StorageWorks documentation. Refer to the accompanying StorageWorks documentation for removal and replacement procedures for all shelves and SBBs.

Intended Audience

This publication is for use by customers and Digital™ employees responsible for configuring, installing, and maintaining the Enterprise Storage Array subsystem and its components.

Structure

This manual contains the information and procedures to support the Enterprise Storage Array configuration and is organized as follows:

- Chapter 1 presents an overview of the StorageWorks Enterprise Storage Array.
- Chapter 2 presents an overview of all SBB devices and their operations.
- Chapter 3 describes the controller and controller operating software.
- Chapter 4 describes power and controller configuration, and shows cabling interconnections.
- Chapter 5 describes how to prepare your host operating system to successfully operate with ESA.
- Chapter 6 describes the StorageWorks Command Console and provides instructions for installing it.
- Glossary

Documentation Conventions

This guide uses the following conventions:

Convention	Description
boldface type	Boldface type indicates the first instance of terms being defined in text, in the glossary, or both.
<i>italic type</i>	Italic type indicates emphasis and complete manual titles. In the glossary, italic type also is used to indicate cross-references.

Related Documentation

The following table lists StorageWorks user documentation shipped with the Enterprise Storage Array.

Provided Documentation

Document Title	Order Number
<i>HSZ50 Array Controller, Operating Software V 5.0, Release Notes</i>	EK-HSZ50-RN
<i>CLI Reference Manual</i>	EK-HSCLI-RM
<i>Configuring Your StorageWorks Subsystem</i>	EK-HSZ50-CG
<i>Servicing Your StorageWorks Subsystem</i>	EK-HSZ50-SV
<i>StorageWorks Solutions Enterprise Storage Arrays Installation Guide</i>	EK-SWESA-IG
<i>Enterprise Storage Arrays SBB User's Guide</i>	EK-ESA35-UG

The following table lists StorageWorks user documentation related to, but not shipped with the Enterprise Storage Array.

Other Documentation

Document Title	Order Number
<i>StorageWorks Solutions 24-Shelf Data Center Cabinet (SW800-Series) User's Guide</i>	EK-SW800-UG
<i>StorageWorks Solutions 7 Device, 16-Bit SBB Shelf (BA356-S) Series User's Guide</i>	EK-BA356-UG
<i>StorageWorks Solutions 8-Bit I/O Module (BA35X-MG) User's Guide</i>	EK-35XMG-UG
<i>StorageWorks Solutions Configuration Planning Guide</i>	EK-BA350-PG
<i>StorageWorks Solutions SBB User's Guide</i>	EK-SBB35-UG
<i>StorageWorks Solutions Product Catalog</i>	EK-BA350-PC

Manufacturer's Declaration

This section describes environmental, physical, electrical, and safety specifications of the Enterprise Storage Array Subsystems.

Electromagnetic Compatibility

The Enterprise Storage Arrays Subsystems are CE-Mark Class A certified and you can install it in a commercial or office environment.

WARNING!

This is a Class A product. In a domestic environment this product may cause radio interference in which case the user may be required to take adequate measures.

Achtung!

Dieses ist ein Gerät der Funkstörgrenzwertklasse A. In Wohnbereichen können bei Betrieb dieses Gerätes Rundfunkstörungen auftreten, in welchen Fällen der Benutzer für entsprechende Gegenmaßnahmen verantwortlich ist.

AVERTISSEMENT!

Cet appareil est un appareil de Classe A. Dans un environnement résidentiel cet appareil peut provoquer des brouillages radioélectriques. Dans ce cas, il peut être demandé à l'utilisateur de prendre les mesures appropriées.

Safety

The Enterprise Storage Array Subsystems have been tested and are in compliance with the following safety standards.

Note

The equipment described in this manual is listed by the Underwriters Laboratories Incorporated (UL) and bears the UL Listing mark. These cabinets are also certified by the Canadian Standards Association (CSA) and TÜV Product Service GmbH and bear both the CSA certification and TÜV GS marks. This equipment also complies with the CE-Mark Class A requirements.

Note

Das in diesem Manual beschriebene Gerät wurde von TÜV Product Service GmbH auf Sicherheit geprüft und trägt das GS Zeichen. Bitte beachten Sie, daß Eingriffe in das Gerät, Reparaturen oder der Einbau von Erweiterungen nur von Digital Personal erfolgt dar, da sonst die GS Zulassung ungültig wird. Die Zulassung wird auch ungültig, wenn nicht von Digital aualifizierte Speichererweiterungen eingebaut werden. Das Gerät muß so aufgestellt werden, daß die Steckdose frei zugänglich ist.

Acoustic Noise Declarations

These cabinets and shelves have been tested in the indicated configurations. In the following tables 1 B (Bel) = 10 dBA.

Cabinet Acoustics — Preliminary Declared Values per ISO 9296 and ISO 7779

Product	Sound Power Level L _{WAd} , B		Sound Pressure Level L _{pAm} BA, (Bystander Positions)	
	Idle	Operate	Idle	Operate
SW800-Cabinet with only cabinet fans operating	6.4	6.4	55.7	55.7
SW800-Cabinet with: Cabinet fans operating 3 — Controller shelves (BA350–M series) 18 — SBB Shelves (BA356–series)	6.8	6.9	58.9	59.9
16-Bit SBB Shelf (BA356-JC series) with: 2 — Dual Speed Blowers (BA35X-MD) 2 — 150W ac input Power Supplies (BA35X-HF)	5.6	5.6	37	37
16-Bit SBB Shelf (BA356-JC series) with: 2 — Dual Speed Blowers (BA35X-MD) 2 — 150W ac input Power Supplies (BA35X-HF) 6 — 4.3 GB 7200 RPM Disk Drives (RZ29B–VA) 1 — 8–bit I/O Module (BA35X–MG)	5.8	5.9	40	41

Gerät	Schalleistungspegel L _{WAd} , B		Schalldruckpegel L _{pAm} , dBA (Beistehende Position)	
	Leerlauf	Betrieb	Leerlauf	Betrieb
SW800-Cabinet with only cabinet fans operating	6.4	6.4	55.7	55.7
SW800-Cabinet with: Cabinet fans operating 3 — Controller shelves (BA350–M series) 18 — SBB Shelves (BA356–series) containing	6.8	6.9	58.9	59.9
16-Bit SBB Shelf (BA356-JC series) with: 2 — Dual Speed Blowers (BA35X-MD) 2 — 150W ac input Power Supplies (BA35X-HF)	5,6	5,6	37	37
16-Bit SBB Shelves (BA356-JC series) with: 2 — Dual Speed Blowers (BA35X-MD) 2 — 150W ac input Power Supplies (BA35X-HF) 6 — 4.3 GB 7200 RPM Disk Drives (RZ29B–VA) 1 — 8–bit I/O Module (BA35X–MG)	5,8	5,9	40	41

Overview of the Enterprise Storage Array

This chapter provides a description of the major components of the StorageWorks Enterprise Storage Array (ESA) for I/O Intensive Applications. It also gives important prerequisite information to ensure successful installation of the ESA.

1.1 Introduction

The ESAxxx-C4 are fully integrated storage solutions that are ideal for heavy transaction-oriented applications, including most office automation applications.

The ESA solutions architecture incorporates the latest in StorageWorks RAID controller technology as well as the StorageWorks Command Console, an easy-to-use centralized configuration and management tool.

1.2 Prerequisites

You will need the following software and hardware to complete your ESA installation:

- A FWD SCSI-2 host adapter to connect to the ESA controller.
- A personal computer on which to run the StorageWorks Command Console (SWCC) program (refer to Chapter 6 for minimum PC configuration requirements).
- A serial connection to the controllers which can be established either from your PC running communication software, or from a maintenance terminal. Refer to the *Configuring Your StorageWorks Subsystem* manual and the *HSZ50 CLI Reference* manual for detailed information about serial connection requirements and the required CLI commands.

1.3 Major Components

This section describes the major components of the ESA as shown in Figure 1-1.

Figure 1-1 ESA Major Components

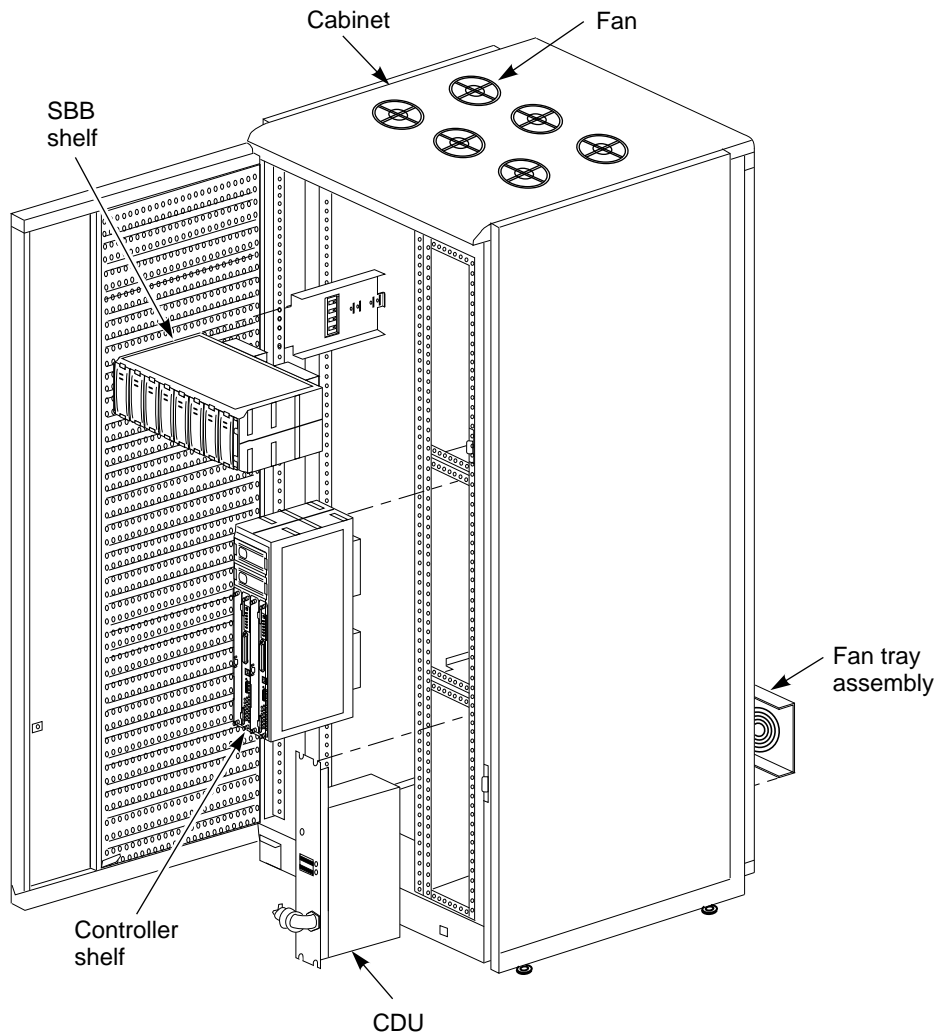

CXO-5414A-MC

1.3.1 Cabinet

The cabinet has 19 horizontal and 4 vertical shelf positions. Controller shelves are installed in the middle and upper vertical shelf positions. The lower vertical shelf positions in the front and rear of the cabinet are each reserved for CDU installation and cable routing. Storage shelves are installed in the horizontal positions.

- Power—The cabinet and StorageWorks shelves are configured for redundant power. This configuration consists of two cable distribution units (CDUs) in the cabinet and two power supplies in each shelf. Each CDU requires a different power source. The primary shelf power supply connects to CDU A and the redundant shelf power supply connects to CDU B.
- Cooling—The cabinet fans and the shelf blowers provide airflow through the shelves and the cabinet. Each StorageWorks shelf contains two rear-mounted blowers that move heat from the shelf into the cabinet interior. Six fans in the top of the cabinet draw air up through the center of the enclosure to blow the interior heat out through the top. Logic signals allow the status of the shelf blowers to be monitored by the host system.

1.3.2 SBB Shelves

StorageWorks building block (SBB) shelves house the SBBs in the StorageWorks family. The shelves have two power supply SBBs and a number of standard SBBs. SBB shelves have mechanical mounting, power, and signal interfaces for the SBBs they house.

1.3.3 StorageWorks Building Blocks

StorageWorks building blocks are modular computer devices or power units from the StorageWorks family. SBBs may be disk drives, shelf power supplies, or external cache batteries (ECBs). They are housed in 3.5-inch wide modular carriers that plug into slots in the SBB shelves. Connectors on the rear of each SBB mate with connectors in the SBB shelf to provide the electrical interface between the two units.

1.3.4 Cable Distribution Unit

Cable distribution units (CDUs) provide the connections necessary to distribute ac power to the shelves and fans within the cabinet. CDUs also provide surge and spike protection, along with a circuit breaker to control the incoming ac power. The two CDUs are configured with two separate ac power sources to provide redundant primary power within the cabinet. One CDU is installed in the lower vertical opening in each side of the cabinet.

1.3.5 Array Controller Shelves

Array controller shelves are StorageWorks shelves designed specifically to house SCSI peripheral controller and cache memory modules. These shelves also have two power supply SBBs. Controller shelves provide the mechanical mounting, power, and signal interfaces for the units they house.

1.3.6 Array Controller

The array controller is the intelligent bridge between your host and the devices in your subsystem. The controller attaches to the host computer system using a fast, wide, differential (FWD) SCSI-2 bus. *Configuring Your StorageWorks Subsystem* contains a detailed description of the controller and its functionality.

1.3.7 Array Controller Software

The array controller operating software (HSOF) is the software component of the controller. It processes SCSI I/O requests from the host and performs the device-level operations required to satisfy the requests.

1.3.8 Fan Trays

The bottom rear-mounted fan tray occupies one shelf to provide improved cooling for 7200 rpm devices, such as the RZ29B-series disk drive. The three fans exhaust air out of the bottom rear of the cabinet.

1.3.9 StorageWorks Command Console Software

The SWCC is a graphical user interface (GUI) and network management program for StorageWorks controllers. It provides a method of monitoring, configuring, and troubleshooting your Enterprise Storage Array. Refer to Chapter 6 for a complete description of the SWCC and instructions for installing it.

SBB Device Operation

This chapter describes the SBB shelf, the SBBs (disk drives, shelf power supplies and external cache batteries) and will familiarize you with the operation of the SBB devices, and assist you in interpreting fault LEDs.

2.1 The SBB Shelf

This section provides a description of the SBB shelf and its components. Refer to the *StorageWorks Solutions 7 Device 16-Bit SBB Shelf BA356–S Series User's Guide* for more detailed information about the SBB shelf.

- The capacity of the shelf is eight 3.5-inch SBBs, (2 power supply SBBs and 6 device SBBs) and an I/O module.
- The SBB slots are numbered 0 through 7 from right to left starting with the slot adjacent to the I/O module (see Figure 2-1).
- The I/O module provides a multifunction 8-bit extension of the 16-bit SCSI backplane. It functions as a platform onto which a wide range of logical and interactive circuitry can be connected (see Figure 2-2).

Figure 2-1 SBB Shelf

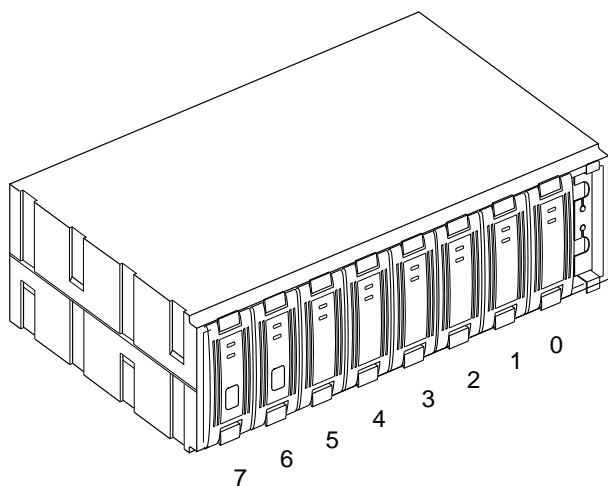

CXO-5411A-MC

Figure 2-2 SBB Shelf with I/O Module

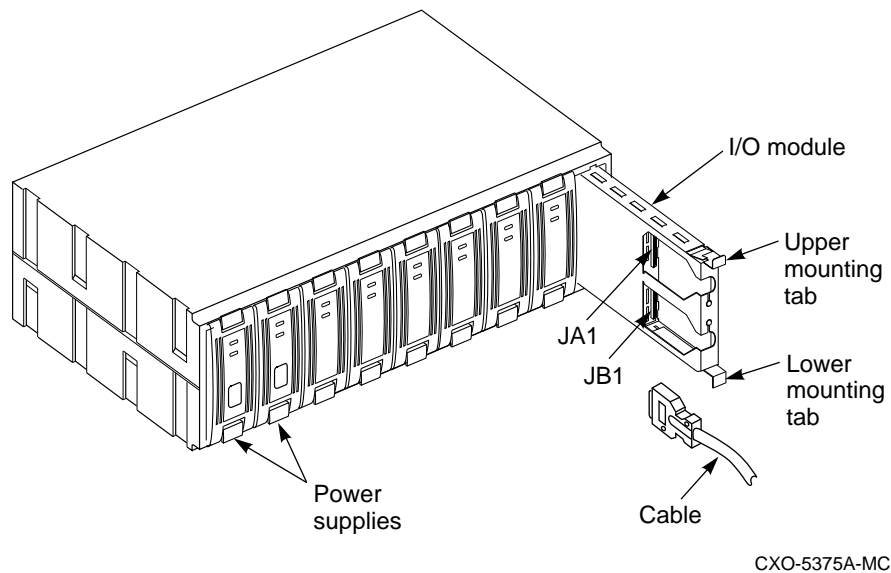

- There are six SCSI bus device addresses (that is, **target IDs**) that are numbered 0 through 5. These addresses are assigned to 3.5-inch SBBs based on the slots into which they are mounted.
- The single shelf SCSI device addresses and the slot numbers are the same for slots 0 through 5.
- Slot 6 is used for the redundant SBB power unit.
- Slot 7 is reserved for the shelf power unit and does not have a device address.
- There are two 50-pin, high-density, female SCSI connectors on the 8-bit I/O module that are used for I/O and daisy chaining shelves.
- As shown in Figure 2-3, each shelf has two blowers mounted on the rear of the shelf. These blowers pull air through the shelf and exhaust it out the rear.

Figure 2-3 Blower Assembly

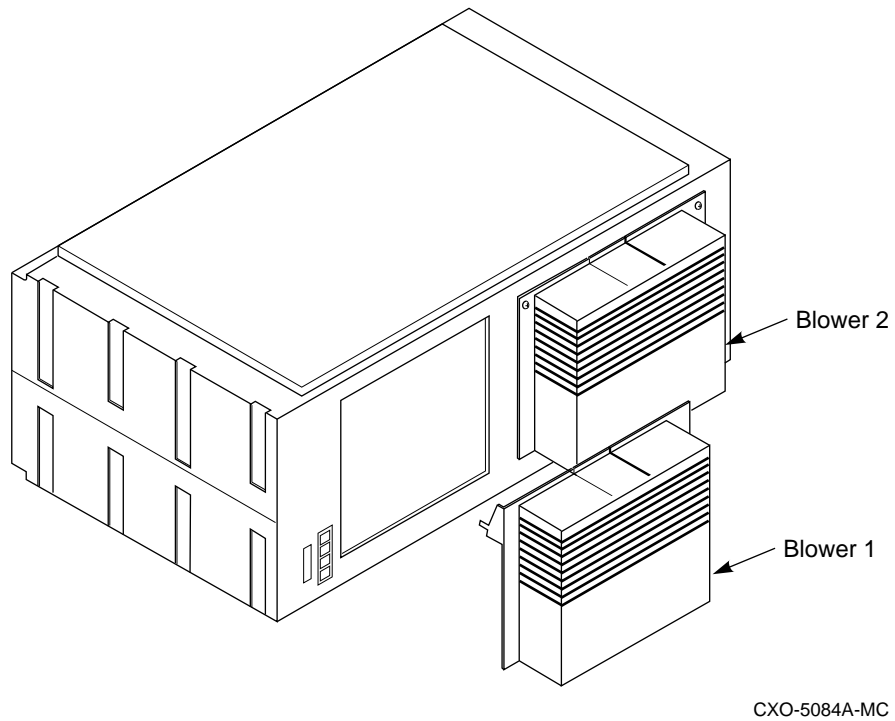

- The I/O module monitors the blower operation via the logic signals on the backplane:
 - When a high-ambient temperature condition is detected, both blowers automatically switch to high speed.
 - When one blower is defective, the other blower automatically switches to high speed to compensate.
 - The backplane supports the SCSI-2 and SCSI-3 bus.

2.2 Power Supply Fault Notification

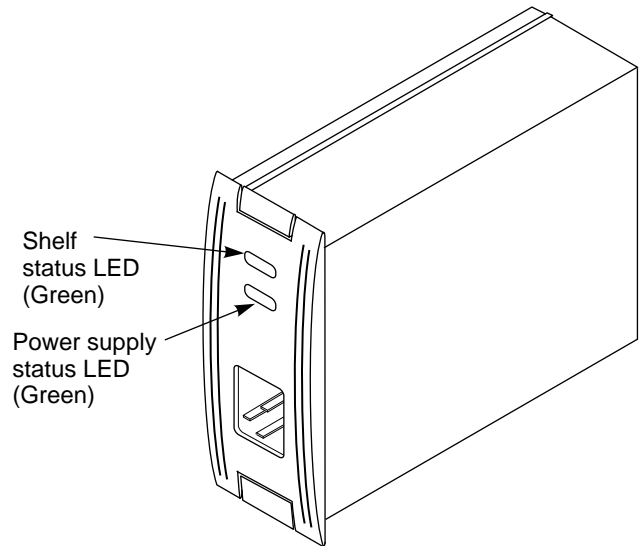

As shown in Figure 2-4, each power supply SBB has two green LEDs that display the power supply status. Table 2-1 describes the state of these LEDs, the status being reported, and the recommended corrective action.

Figure 2-4 3.5 --Inch Power Supply SBB



CXO-4787A-MC

Table 2-1 Power Supply Status LED Displays

When the LED display is...	The SBB power supply status is...
	All the power supply SBBs on the <i>associated</i> power bus (either power bus A or power bus B) are functioning properly.
	At <i>least one</i> power supply SBB on the associated power bus has malfunctioned. This power supply SBB is functioning properly. Corrective Action: Identify and replace the defective power supply SBB.
	Either there is no ac power, the CDU has failed, or this power supply SBB has failed. Corrective Action: 1. Check that ac power is applied. 2. Check the associated ac power entry controller for proper operation. Replace if necessary. 3. This power supply has failed and must be replaced.

2.3 Storage Device Fault Notification



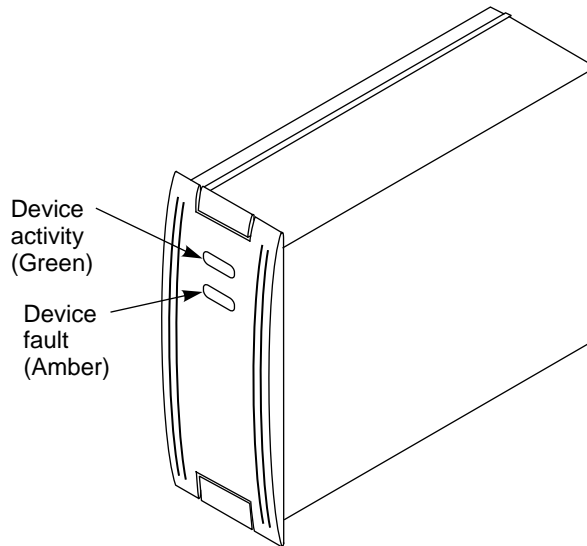

As shown in Figure 2-5, each 4.3 GB disk drive SBB has two LEDs that display the device status. Table 2-2 describes the state of these LEDs, the status being reported, and the recommended corrective action.

Figure 2-5 4.3 GB Disk Drive SBB



CXO-4652A-MC

Table 2-2 Disk Drive SBB Status LED Displays

When the LED display is...	The device SBB status is...
	When the green Device Activity LED is ON or FLASHING, and the amber Device Fault LED is OFF, the SBB is operating normally. There is no fault.
	When the green Device Activity LED is OFF and the amber Device Fault LED is OFF, the device is inactive and the SBB is operating normally. There is no fault.
	Fault Status. When the green Device Activity LED is ON and the amber Device Fault LED is ON, the device is probably not responding to control signals. Corrective Action: 1. Quiesce the bus. 2. When the drive is spun down, replace the SBB.
	Fault Status When the green Device Activity LED is ON and the amber Device Fault LED is FLASHING, the SBB is active and is spinning down. Recommended Corrective Action: 1. Quiesce the bus. 2. When the device is spun down (the green LED is OFF), replace the SBB.

2.4 I/O Module Fault Notification

This section describes the 8-bit I/O module (see Figure 2-6) and provides information to assist you in interpreting fault LEDs.

Figure 2-6 8-Bit I/O Module

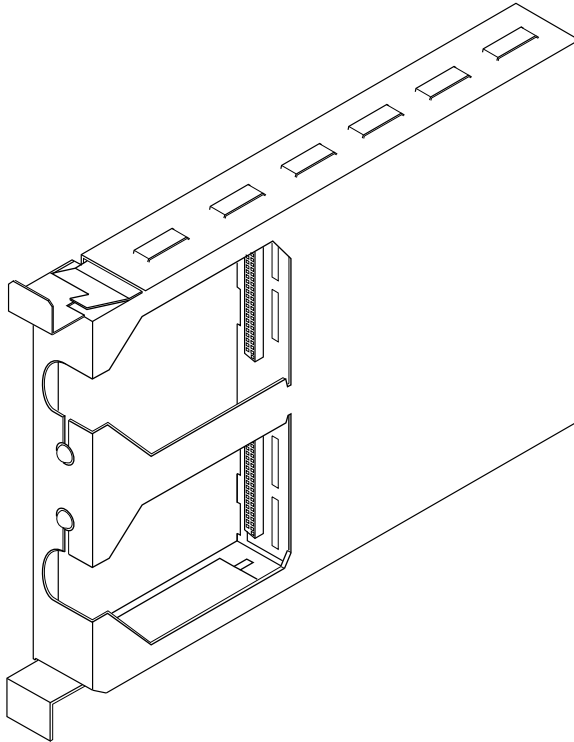

CXO-4821A-MC

The I/O module employs active circuitry to provide the following features to the SBB shelf:

- Eight-bit data bus connections to external units
- Shelf device address assignment
- Blower speed control
- Blower fault indicators
- Ambient air overtemperature sensing and indication
- Active, automatic bus termination

The 8-Bit I/O module is located on the right side of the SBB shelf to the right of slot 0 (see Figure 2-1).

On the front of the I/O module (see Figure 2-7) are two 50-pin female connectors: bus connector JA1, the data input connector, and bus connector JB1, the data output connector. In a split-bus configuration, both JA1 and JB1 are input connectors.

Guides embossed on the top and bottom of the I/O module prevent inserting the I/O module upside down and keep the module centered in the shelf slot. Two spring-steel mounting tabs lock into ledges molded into the top and bottom of the shelf secure the I/O module. Squeeze the mounting tabs together to pull the I/O module out of the shelf.

The upper LED indicates that the left blower motor has failed. The lower LED indicates that the right blower motor has failed. Fans at the rear of the shelf draw air from the front to cool the I/O module.

Figure 2-7 I/O Module Features

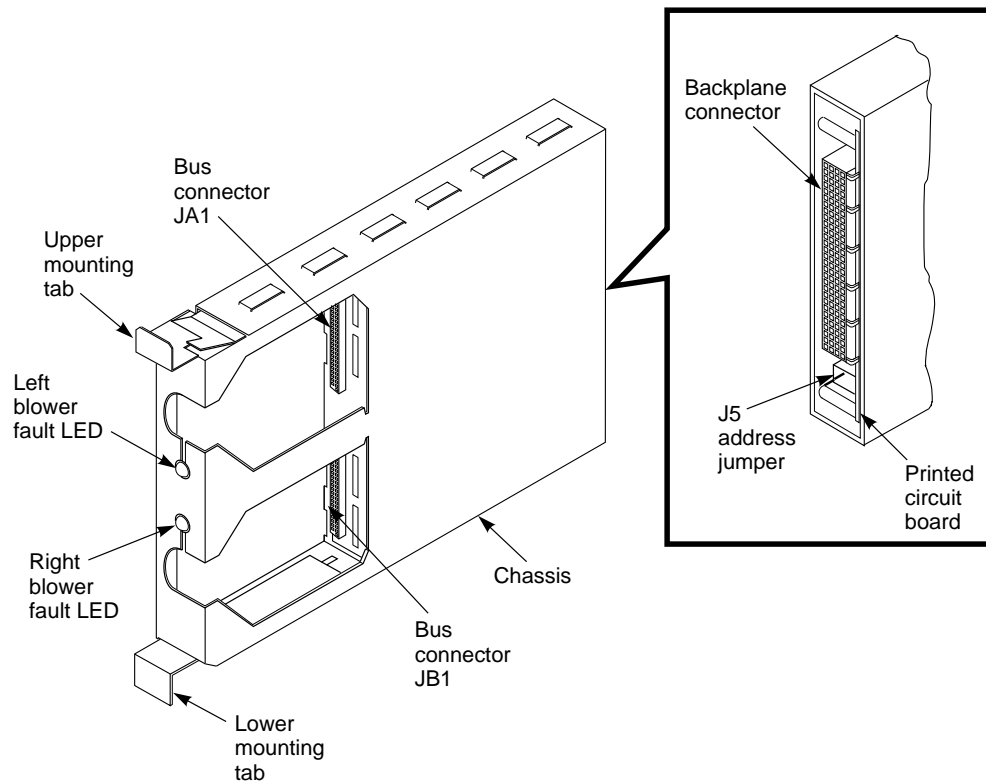

CXO-4536A-MC

2.4.1 Data Bus Connections

The I/O module provides an external connection for the SBB shelf buses. The backplane connector on the rear of the I/O module (see Figure 2-7) routes the bus and control signals from the shelf backplane to the I/O module circuits. These circuits connect the lower eight bits (0 through 7) of bus A to external bus connector JA1 and the lower eight bits of bus B to external bus connector JB1.

2.4.2 Bus Termination

The I/O module provides both active and passive bus termination for the two 8-bit shelf buses. The upper eight bits (8 through 15) of each bus are passively terminated by termination resistors. These data lines do not pass to the external bus connectors (JA1 and JB1). The lower eight bits (0 through 7) of SCSI bus B are actively terminated. These data lines are terminated as long as there is no connection to JB1. When JB1 is connected, the active terminators are disabled and these data lines pass through JB1.

2.5 SBB ECB Shelf Fault Notification

This section describes the SBB ECB and provides information to assist you in interpreting the fault LEDs. The external cache batteries are mounted in an SBB shelf without a backplane. The shelf is a repository for ECBs only (see Figure 2-8). The ECB is connected to the array controller's cache module by an external cable (see Figure 2-9).

Figure 2-8 SBB ECB Shelf

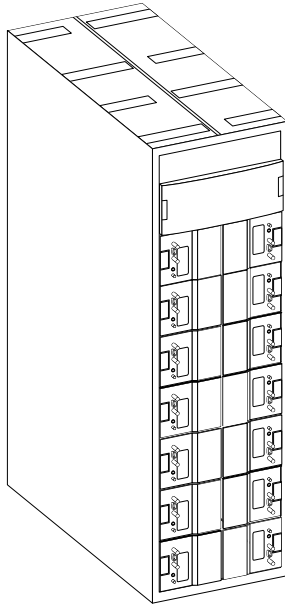

CXO-5408A-MC

The cache module is mounted under the controller and is identified by the single plug in the middle of the module (see Figure 2-9).

Note

The cables connecting the cache module to the ECB are factory installed. To remove or replace the controller, cache, or ECB, refer to the *Servicing Your StorageWorks Subsystem* manual.



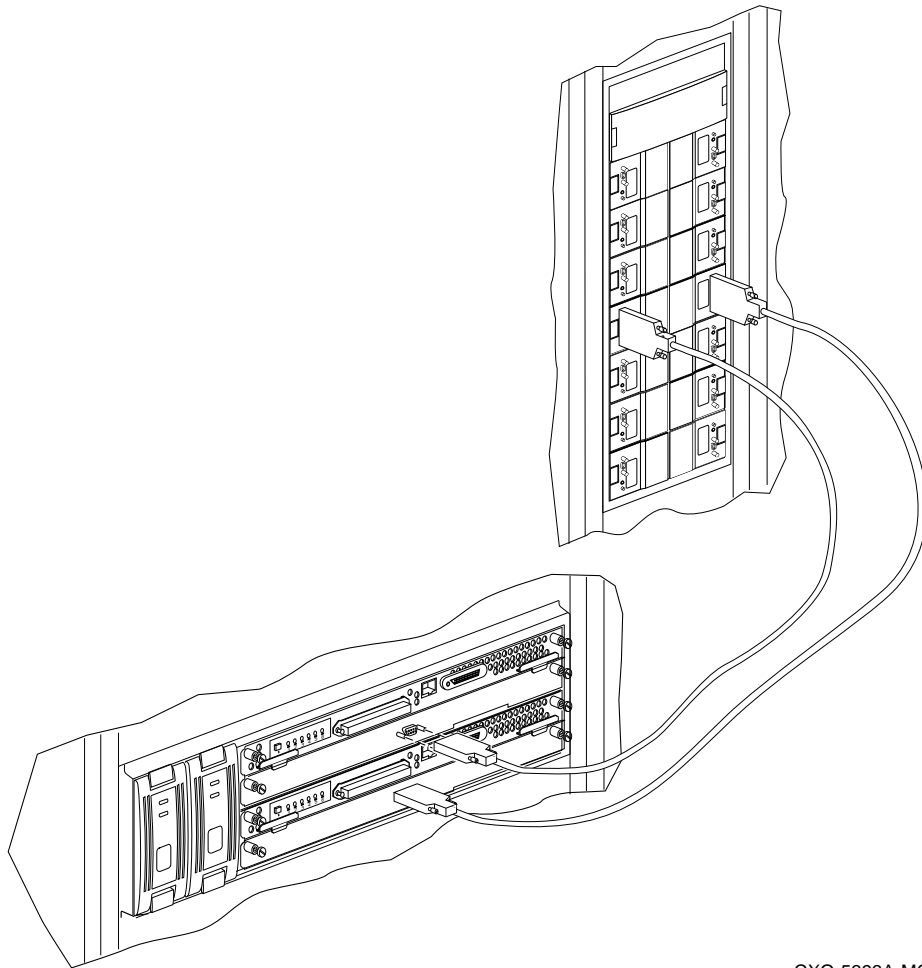

Figure 2-9 Cache to ECB Connection



CXO-5393A-MC

Each ECB supports two cache modules. To check the ECB status, look at the ECB status indicator LED (one for each cache module) for the appropriate indication (see Table 2-3 and Figure 2-10).

Table 2-3 ECB Status Indications

LED status	Battery status
	System power is on, and the ECB is fully charged.
	System power is on, and the ECB is charging.
	System power is off, and the ECB is supplying power to the cache.
	System power is off, and the ECB is not supplying power to the cache.





Legend:  = On  = Off  = Blink fast  = Blink slow

Figure 2-10 ECB SBB



CXO-5267A-MC

Controller Operations

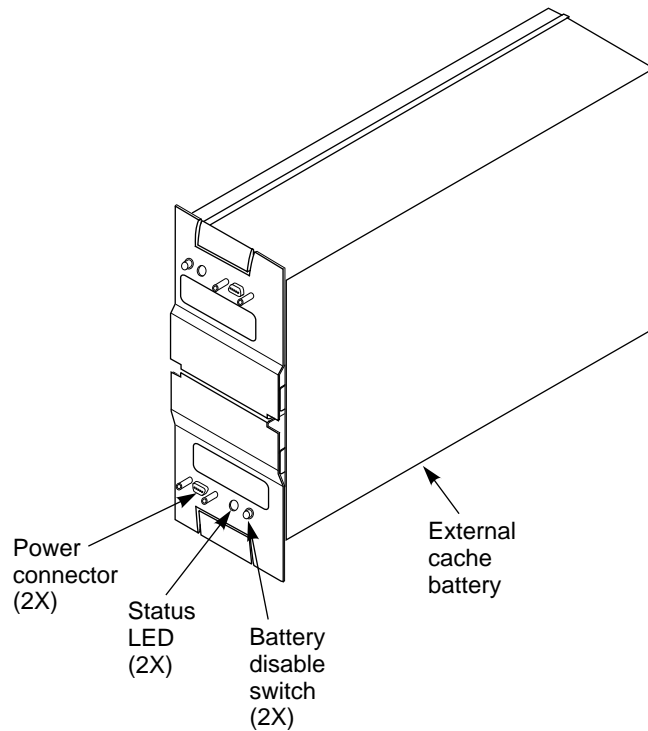
This chapter describes how the controllers are mounted in the ESA and how to check that your program card, containing the controller operating software, is installed.

3.1 Controller Mounting

Controller shelves are mounted horizontally (see Figure 3-1) and vertically (see Figure 3-2). The primary controller is mounted in the bottom shelf slot (SCSI ID 7) and the redundant controller is mounted in the top shelf slot (SCSI ID 6).

The trilink connector attaches to the controller host port and the Bus cable from the host attaches to the trilink connector. The jumper cable and terminator are factory installed for ESA (see Figure 3-1).

Figure 3-1 Horizontal Mounted Controllers with Cache and Trilink Connectors

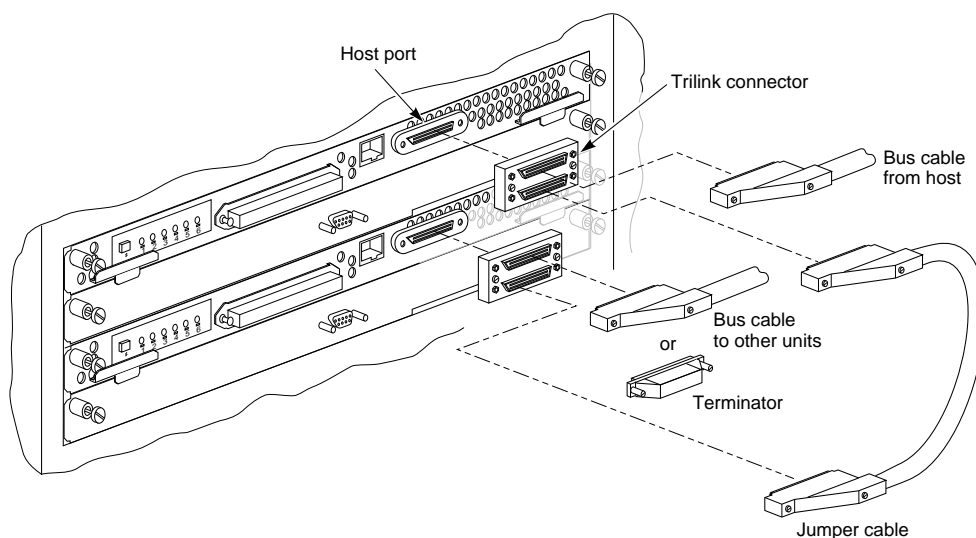

CXO-5301A-MC

Figure 3-2 Vertical Mounted Controllers with Cache

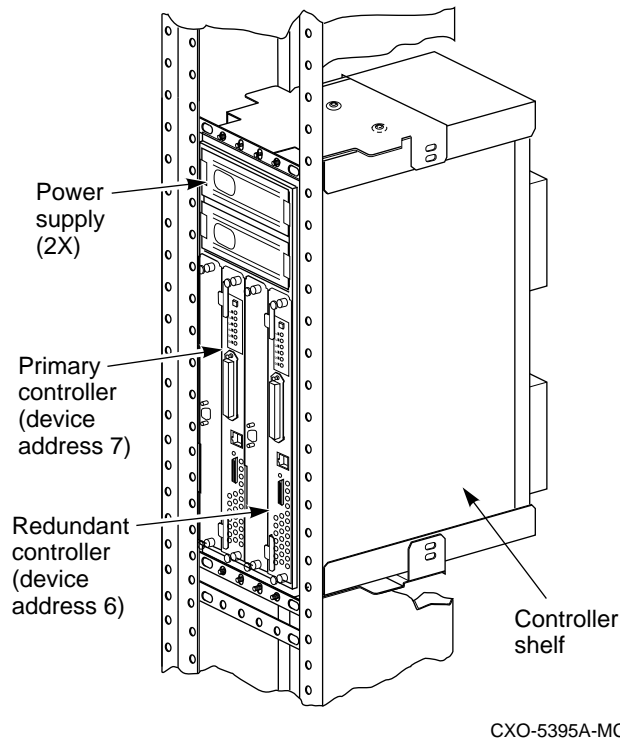

3.2 The Controller Operating Software (HSOF)

The program card contains the controller operating software (HSOF) and is factory installed.

Caution

The program card *must* remain inserted at all times during controller operation with the ESD cover in place. If the program card is removed during operation, the controller *will not* function and you must restart the controller by pressing the reset button.

Check to be sure your ESA subsystem contains the program card using the following procedure (see Figure 3-3):

1. Attach an ESD grounding strap to your wrist at one end and the cabinet grounding stud at the other.
2. Remove the program card ESD cover.
3. Check for the presence of the program card.
4. Snap the ESD cover in place over the program card.

Figure 3-3 Location of Program Card ESD Cover

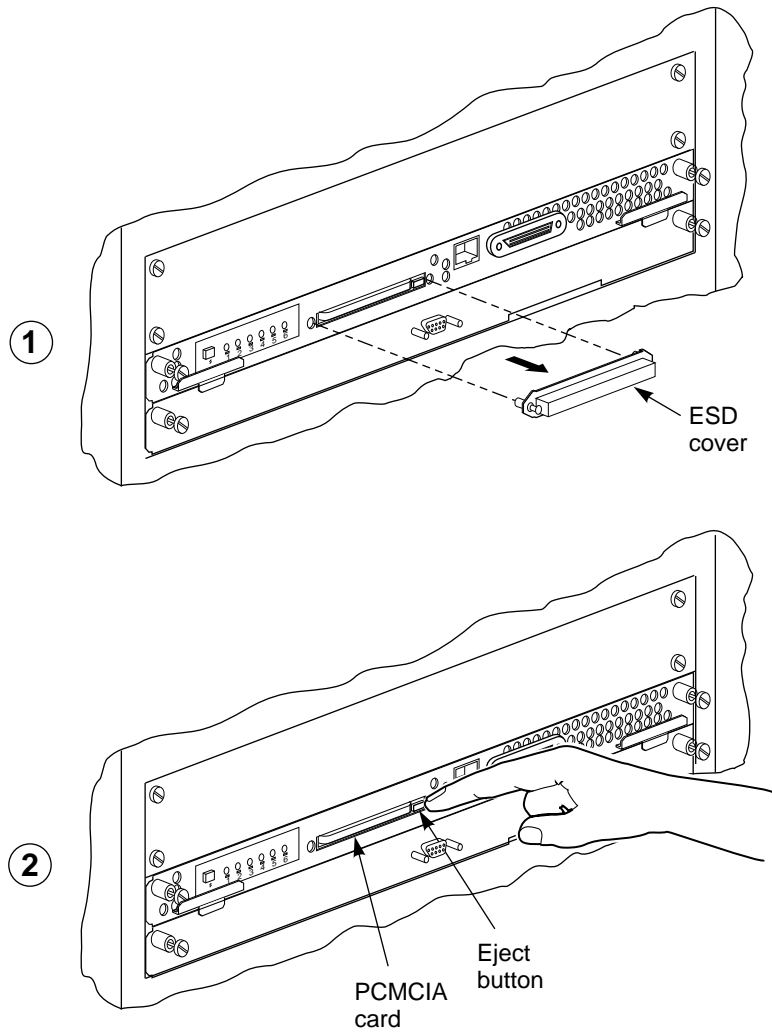

CXO-5302A-MC

Should you need to replace your program card (either because of a firmware upgrade or a bad program card), refer to the replacement procedures in the *Servicing Your Storage Subsystem* manual.

ESA Configuration

This chapter describes the ESA power configuration and controller/drive configuration. The shelf cabling is illustrated to enable you to physically locate disks in the cabinet according to their disk unit number..

WARNING

Electric Shock Hazard! Before working inside the cabinet, remove power from the cabinet and its components. Failure to do so may result in death or personnel injury.

Note

You will be instructed when to apply power to your ESA cabinet. Refer to Chapter 5, in the section specific to your operating system, for these instructions.

4.1 Redundant Power Configuration

All ESA systems use the redundant CDU power configuration illustrated in Figure 4-1: CDU A is connected to the primary power source and CDU B is connected to the redundant power source. CDU A provides power to the primary power supply SBB in each shelf and CDU B provides power to the redundant power supply SBB in each shelf. If the primary power source CDU A, or primary power supply SBB fails, the shelf remains powered by the redundant power supply. This configuration provides complete power redundancy to the shelf peripheral devices.

Figure 4-1 Dual CDU Power Configuration

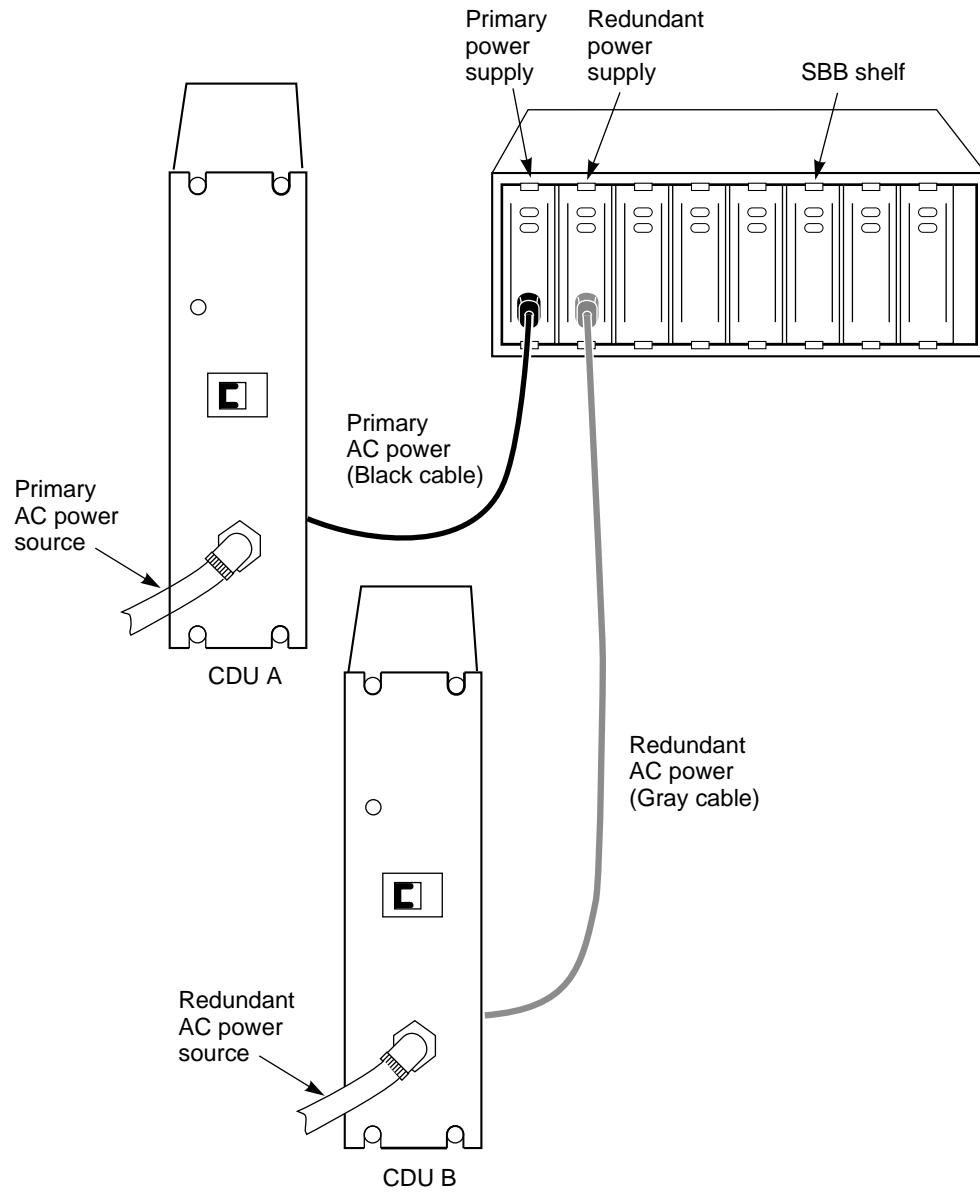

CXO-5396A-MC

4.2 Controller/Drive Configuration

The cabinet is cabled at the factory. This section shows all the SBB shelves and the controllers to which they are connected. The controller port numbers are also shown. Each SBB shelf contains an 8-bit I/O module, two power supplies, and SBBs, as illustrated in Figure 4-2. Each controller shelf contains a redundant controller pair. Figure 4-3 shows a controller shelf with I/O cable connectors. Refer to the appropriate user's guide for detailed information about the cabinet, the shelves, and the I/O modules.

Figure 4-2 SBB Shelf with 8-Bit I/O Module

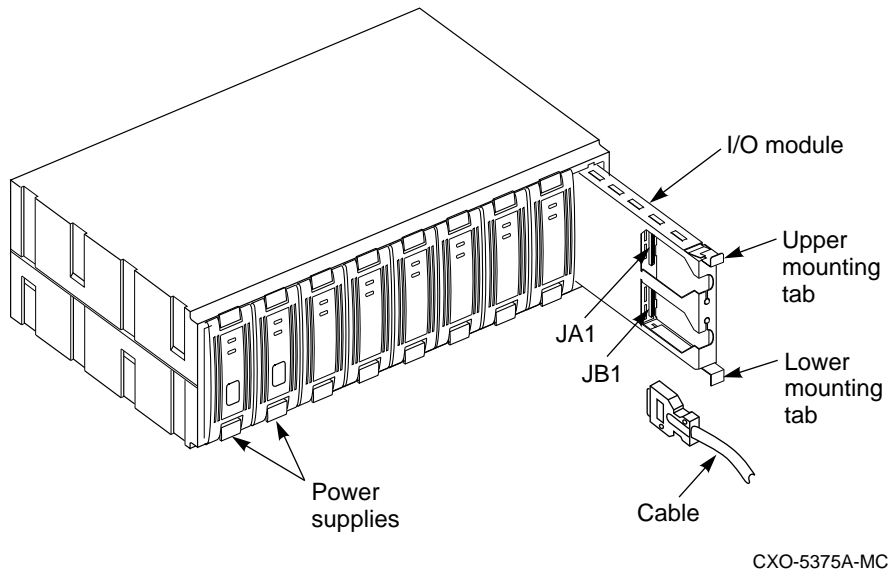
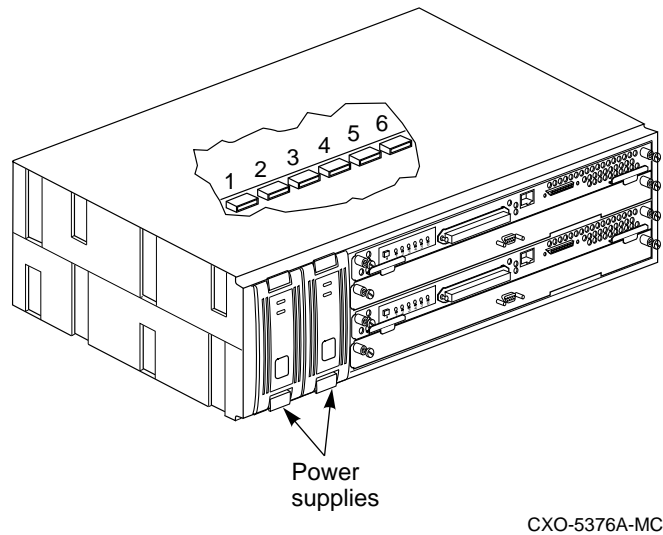

Figure 4-3 Controller Shelf with I/O Connectors



The ESxxx-C4 cabinet is configured with six SBB shelves per controller pair, as shown in Figure 4-4 and Figure 4-5. Each controller port (1-6) controls six drives, or one SBB shelf. The port controlling each shelf is indicated in the figures.

Note

In the following figures, the six SCSI cables connecting the controllers to the SBB shelves are represented by a single line.

Figure 4-4 Model ESxxx-C4 (Part # SW8T1)

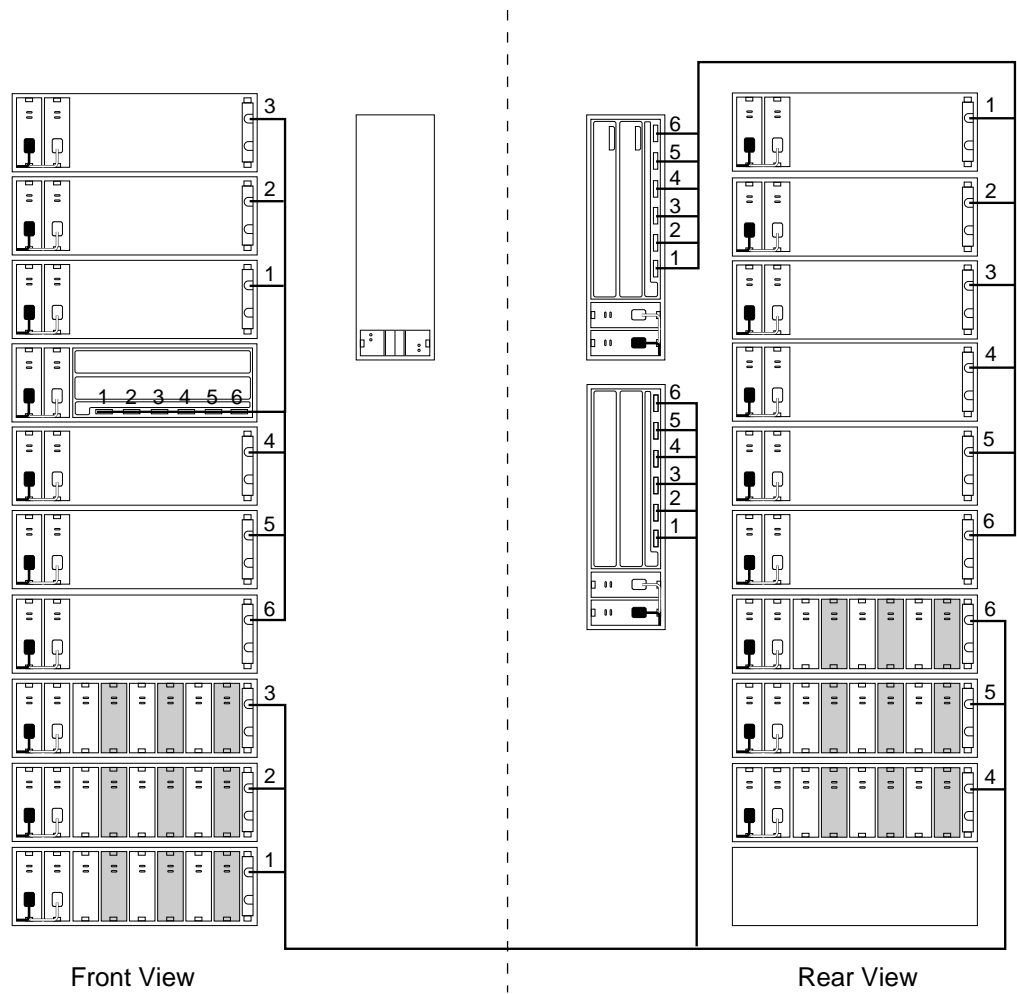

CXO-5517A-MC

Figure 4-5 Model ESxxx-C4 (Part # SW8T2, 3, and 4)

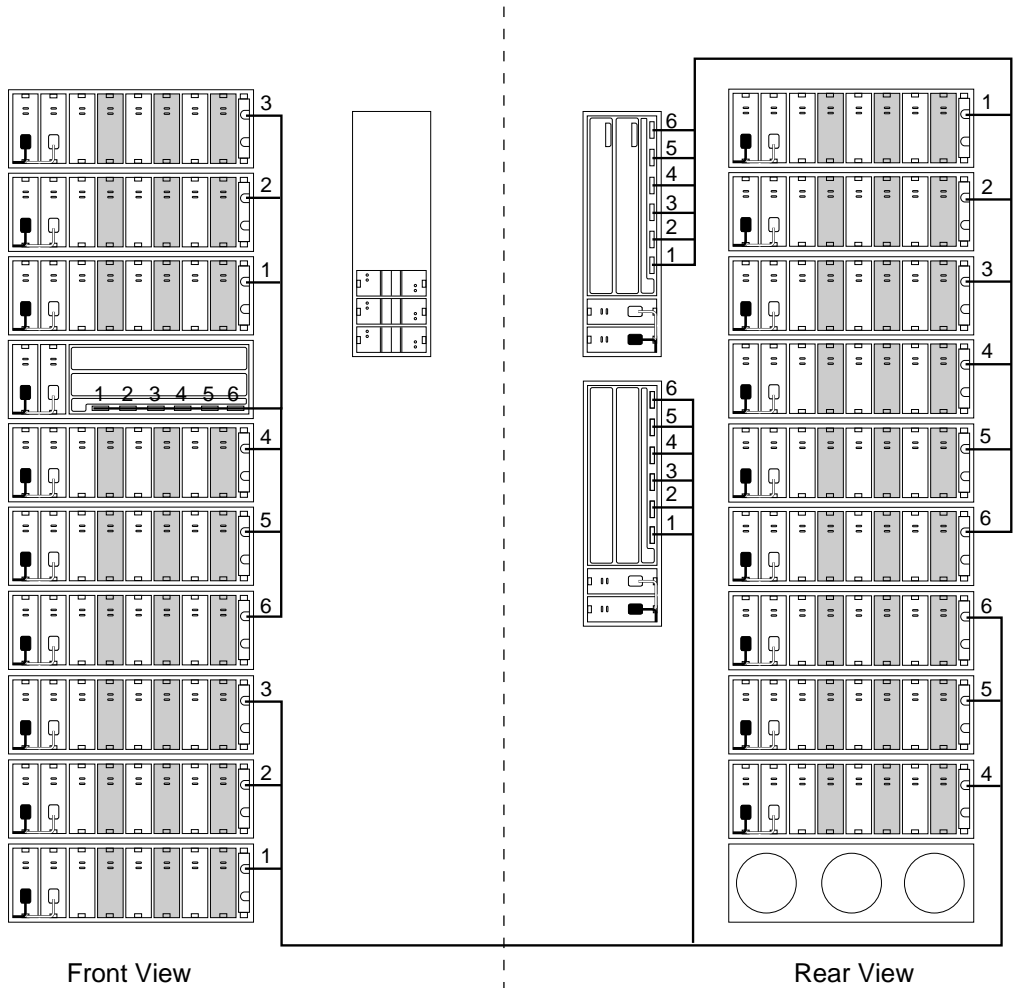

Front View

Rear View

CXO-5520A-MC

Preparing Your Host System to Operate with ESA

This chapter describes the steps necessary to bring your ESA and host system online. It also points you to the procedures for creating a communications logical unit number (LUN) to install device drivers, and assists you through the process of modifying your host operating system to meet ESA requirements.

5.1 Applying Power to the ESA Cabinet

Before you perform any procedures in this chapter, you must first apply power to the ESA. The ESA must be powered on for 6 hours to ensure the write-back cache batteries are fully charged (required for RAIDsets).

Apply power to the cabinet using the following procedure:

1. Open the front and rear cabinet doors.
2. Switch CDU A and CDU B front panel circuit breakers to the | (ON) position (refer to Figure 4-1).
3. Check to make sure all the controllers have initialized. If the controller initializes correctly, the green reset LED will begin to flash one time per second.

Note

If an error occurs during initialization, the controller operator control panel (OCP) displays an error code. Refer to *Servicing Your StorageWorks Subsystem* to interpret the LED codes.

4. Close the front and rear cabinet doors.

5.2 Logical Unit Number Requirement

You need to create a logical unit on your ESA subsystem to establish a connection between the subsystem and your host system. This logical unit must remain on each of your subsystems in order to maintain connections with your host system. Digital recommends creating and designating a RAID 5/3 one-block partition logical unit as the communications LUN.

Refer to the *Getting Started RAID Array 450 Installation Guide* specific to your operating system for detailed information about creating LUNs.

5.3 Connecting SCSI Cables to the Controllers

Caution

Do not connect or disconnect the SCSI bus cable at the host adapter with the host powered on as it could damage the host adapter or disrupt system operation.

The ESA uses HSZ-series controllers with the SCSI interface as the communication path to the host computer and for the storage device bus. Use the following cabling guidelines to route the SCSI cables to each controller:

- Install all SCSI host interface cables through openings at the bottom rear of the cabinet (same entry point as the power cables).
- If the controllers are located at the rear of the cabinet, route the cables directly to each controller trilink connector.
- If the controllers are located in the front of the cabinet, route the cables to the front through the openings beside the CDUs.
- After the cables are routed through the cabinet, attach the host SCSI cables to the trilink connectors on the front of each controller (see Figure 3-1).

Note

Do not attach the host SCSI cable to the host adapter until you are directed to do so in the section specific to your operating system.

5.4 Procedures for Your Operating System

This section directs you to the section in the manual that provides you with the information you need to install the required device drivers, and complete the preparation of your system to operate with the ESA.

- **OpenVMS**

If your operating system is OpenVMS, you are not required to install any special device drivers or other StorageWorks software. Proceed directly to Chapter 6 to install the StorageWorks Command Console software to complete your ESA installation.

- **Digital Unix**

If your operating system is Digital UNIX, proceed to Section 5.5 to install the StorageWorks device drivers and complete your ESA installation.

- **HP-UX**

If your operating system is HP-UX, proceed to Section 5.6 to install the StorageWorks device drivers and complete your ESA installation.

- **IBM on AIX**

If your operating system is IBM on AIX, proceed to Section 5.7 to install the StorageWorks device drivers and complete your ESA installation.

- **Solaris**

If your operating system is Solaris, proceed to Section 5.8 to install the StorageWorks device drivers and complete your ESA installation.

- **Windows NT/Alpha**

If your operating system is Windows NT for Alpha, proceed to Section 5.9 to install the StorageWorks device drivers and complete your ESA installation.

- **Windows NT/Intel**

If your operating system is Windows NT for Intel, proceed to Section 5.10 to install the StorageWorks device drivers and complete your ESA installation.

5.5 Preparing Your Digital UNIX System for ESA

This section describes how to install device drivers to allow you to access the storage units on your ESA subsystem from your Digital UNIX host computer. It includes instructions for loading the StorageWorks RAID utilities and instructions for creating device special files in Digital UNIX.

Note

Digital UNIX was formerly called DEC OSF/1. The term "Digital UNIX" is used throughout this Chapter.

You must perform all configuration set up and parameter definitions, and run all utilities from a maintenance terminal or a terminal emulator connected to your controller's terminal port. As an alternative, you can use the HSZterm utility, although it is not covered in this section. See the *StorageWorks HSZ50 Array Controller Utility for Digital UNIX, System Manager's Guide for HSZterm*. The utility and documentation are on Digital UNIX Consolidated software distribution CD-ROM.

5.5.1 Installing the Host Adapter

1. Verify that you have a supported host adapter installed in your Digital Alpha-based system. Table 5-1 lists the supported host adapters.

Table 5-1 Supported Host Adapters

Digital UNIX Version	Host Adapters
3.2D (min.)	Model KZPSA-BB
4.0	Model KZPSA-BB

2. Install the host adapter in an available PCI slot according to the instructions provided with the host adapter or the Digital Alpha-based System.
3. Attach the SCSI cable to the host adapter.

5.5.2 Basic Configuration Steps

Once you have completed the initial setup and configuration of your ESA subsystem, you will be able to use RAIDsets and other storage containers much like single disks, including using them as boot devices.

The configuration steps vary depending upon whether you are running Digital UNIX V3.2D or V4.0. (Proceed to Section 5.5.4 for the configuration steps for V4.0.)

5.5.3 Installing the StorageWorks RAID Utility for Digital UNIX V3.2x

The installation of the StorageWorks RAID Utility for Digital UNIX takes less than one hour to complete. The installation procedures included in this section load the utility onto your system and prepare Digital UNIX to run the utility and interact with the ESA subsystem.

You must perform each of the procedures specified in the following sections to complete the installation and configuration:

- Run the *setld* install utility to install the utility (A sample of the installation script appears in Appendix A of the *Getting Started RAID Array 450 for Digital UNIX Installation Guide*).
- Prepare LUNs for access by the Digital UNIX filesystem.

5.5.3.1 Running the setld Install Utility

Before running the *setld* install utility, perform the following steps:

1. Boot your system with the '/genvmunix' kernel.
2. In order for the Digital UNIX operating system to recognize the HSZ50 array controller, you must change the /sys/data/cam_data.c file. Find the HSZ40 entry, cut and paste to duplicate it. Then change HSZ4 to HSZ5. Rebuild the kernel and copy it to root.
3. Load the RAID Array 450 for Digital UNIX CD-ROM into your CD-ROM drive.
4. Extract the subsets from the distribution CD-ROM by entering the following commands:

```
# mount -r -t cdifs -o rrip /dev/rz6c /mnt
# cd /mnt/du_raid
```
5. Install the subset package from the Bourne shell (sh) root account by entering the following command:

```
# setld -l SWRAID100
```

Installing the package performs the following tasks (which do not need your intervention):

- Checks for the necessary file system space (1MB)
- Displays copyright information
- Checks the current revision of your Digital UNIX operating system and, according to this, installs/updates specific files or utilities
- Checks if you have the /genvmunix kernel booted (which is required to detect all connected hardware)
- Installs your StorageWorks RAID Array Installation Utility for Digital UNIX
- Creates symbolic links for new installed utilities and boot device support
- Creates device special files using the MAKEDEV.hsz script
- Updates the system config files
- Prompts you just before the kernel rebuild starts

5.5.3.2 Creating Device Special Files Manually

Note

In case of an error during the automatic installation of the *SWRAID100* “package”, or if you add disks to your subsystem, you will need to manually create device special files.

Digital UNIX contains a utility that can make all of the device special files for any single unit in a storage subsystem. It creates block and character files for all eight partitions of the unit. Each device special file references the major and minor number of a specific partition. You may use one of the following methods:

- The StorageWorks RAID utilities subset contains a simple utility that scans the available SCSI buses and creates special device file entries.

To perform this task, enter the following commands:

```
# cd /dev
# ./MAKEDEV.hsz
```

This will scan the buses and create device special files as needed. The following is an example output:

```
./MAKEDEV.hsz
Scanning buses, please be patient.....done.
rza8 @ bus1, D000 on DEC HSZ50-AX V50z
MAKEDEV: special file(s) for rza8:
  rzb8 @ bus1, D001 on DEC HSZ50-AX V50z
MAKEDEV: special file(s) for rzb8:
rza9 @ bus1, D000 on DEC HSZ50-AX V50z
MAKEDEV: special file(s) for rza9:
rzc9 @ bus1, D002 on DEC HSZ50-AX V50z
MAKEDEV: special file(s) for rzc9:
Done
```

- Determine the device name as described in the *Getting Started RAID Array 450 for Digital UNIX Installation Guide*. You do not need to add the partition letter at the end of the device name.

As an example, this command creates special device file entries for rzb18 (explained in the *Getting Started RAID Array 450 for Digital UNIX Installation Guide*):

```
# cd /dev
# ./MAKEDEV rzb18
```

In this example, the utility creates block mode files rzb18a through rzb18h and character files rrb18a through rrb18h. You have to repeat this step for each ESA unit you have created.

You are now ready to install the StorageWorks Command Console software. Proceed to Chapter 6 for these instructions.

5.5.4 Rebuilding the Kernel for Digital UNIX V4.0

Digital UNIX V4.0 provides Dynamic Device Recognition (DDR). DDR simplifies the process of adding new devices to your AlphaServer by allowing you to add new devices by rebuilding the Kernel. The Kernel rebuild will automatically configure your ESA into the Kernel and create device driver files for the communications logical unit you created earlier.

To configure your ESA for a system running Digital UNIX V4.0, rebuild your kernel and then reboot the system now. For more information on rebuilding the kernel, see the *doconfig* man page or your System Administration documentation.

You are now ready to install the StorageWorks Command Console software. Proceed to Chapter 6 for these instructions.

5.6 Preparing Your HP-UX System for ESA

This section describes the procedures for installing the required device drivers onto HP 9000 Series systems running HP-UX 10.01 or higher.

Note

When ESA is connected to non-Digital platforms, connection to one host port per controller pair is supported.

5.6.1 Installing the Host Adapter

Fast wide differential (FWD) host adapters manufactured by HP can be used with the ESA and your HP platform. FWD SCSI connectors on add-on or existing host adapters are labeled on the rear panel of your 9000 Series computer.

Note

- If you have not yet installed the host adapter on your HP system, do so now using the instructions provided with the host adapter documentation.
- Do not connect or disconnect the SCSI bus cable with the host powered on as it could damage the host adapter or disrupt system operations.
- Perform the usual back-up and shutdown procedures for your host platform. Turn off power to the host, install the host adapter. Then, power on and reboot the host.
- Prevent SCSI bus ID conflicts. The host adapter ID is usually 7 and, if other equipment is connected to the external bus, avoid the used SCSI IDs.

Use the **isoscand** command described later in this section to determine available device IDs. For optimum RAID array performance, other devices should not be routinely in use on the SCSI bus.

5.6.2 Installing the Host Device Driver

The procedures for installing HP-UX device driver(s) require you to be familiar with following Hewlett-Packard technical manuals:

- *Installing Peripherals*
- *System Administrator Tasks*
- *How HP-UX Works: Concepts for the System Administrator*

Installing the disk driver on HP-UX requires the following major steps:

1. Determine the interface required
2. Verify the availability of the required device driver
3. Reboot the system and verify the successful installation

5.6.2.1 Determine the Device Driver Required

The device drivers you will need for the array controller are listed in Table 5-2. This driver is software configurable and is a standard part of the HP-UX operating system. Device files are automatically created for each ESA device when you follow the procedures listed in this section.

If you use SAM, Table 5-2 provides you with sufficient information to configure your system. However, if you intend to customize your system's configuration, you will need to refer to "Setting Up Devices Using HP-UX Commands" in the *Installing Peripherals* manual. If you need more information on minor numbers, see "Device Files and Minor Numbers" in the *Installing Peripherals* manual.

Table 5-2 HP 9000 Drivers

HP 9000 SYSTEM	Drivers
800 (except K and D class)	disc3, scsi3
700 (C, D, J and K class)	sdisk, c720

5.6.3 Verify Host Adapter and Driver

Verify that you have the required SCSI Host Adapter and drivers available to your system. On a Series 800 System (except for D or K Class machine) enter the following command:

```
# ioscan -f -d scsi3
```

The output from this command will be similar to the following:

Class	I	H/W Path	Driver	S/W State	H/W Type	Description
ext_bus	0	8	scsi3	CLAIMED	INTERFACE	HP 28696A - Fast/Wide SCSI Interface

On a Series 700 System, C, D, J or K Class machine, enter the following command:

```
# ioscan -f -d c720
```

The output from this command will be similar to the following:

Class	I	H/W Path	Driver	S/W State	H/W Type	Description
ext_bus	0	8/7	c720	CLAIMED	INTERFACE	GSC built - Fast/Wide SCSI Interface

5.6.3.1 Editing the Kernel Using SAM

1. Execute SAM
2. Highlight and open Kernel Configuration
3. Highlight and open Drivers
4. Add the necessary drivers

Use SAM's help system to complete the task or refer to "Adding Device Drivers Using SAM" in the *Installing Peripherals manual*.

5.6.3.2 Editing the Kernel Using Commands (if not using SAM)

1. Edit the kernel configuration file using a text editor.
2. Reconfigure the kernel using the **uxgen** command.
3. Refer to "Setting up Devices Using HP-UX Commands" in the *Installing Peripherals manual*.

5.6.4 HP-UX Series 800 Patch Installation (10.01 only)

Series 800 systems running HP-UX 10.01 require HP kernel patch PHKL_7879 to prevent the SCSI bus from hanging under intensive SCSI I/O conditions. Contact your HP service provider for details about obtaining and installing the patch.

5.6.5 Set the SCSI Bus Address of the Array Controller

The SCSI bus address for the array controller is set by the CLI. Refer to Chapter 2 in the *Getting Started RAID Array 450 for HP-UX Installation Guide* for more information on setting SCSI addresses.

5.6.6 Reboot the System and Verify Successful Installation

Note

If you have not already done so, you must configure the See "Creating a Communication Logical Unit" in Chapter 2 of the *Getting Started RAID Array 450 V5.0 for HP-UX Installation Guide* for detailed configuration information.

1. Shutdown the HP system and ensure that all power switches on the array controller and on the host computer system are in the OFF position.
2. Connect the cable to the host SCSI adapter's connector. This cable is a differential to differential connection and is 3 meters in length.
3. Turn on power to the HP system.
4. During the boot process, device "special" files are created for each logical unit configured on the ESA and a Logical Unit number (LUN) is assigned to each storage set configured on the array controller.

After rebooting the new kernel, run **oscan -f** to verify that the drivers are installed, the host adapter status is **OK**, and all the target LUNs are identified

You are now ready to install the StorageWorks Command Console software. Proceed to Chapter 6 for these instructions.

5.7 Preparing Your IBM System for ESA

This section describes the procedures for installing the StorageWorks software and the required device drivers onto IBM systems running AIX 4.1.4 or 4.2. The installation steps include organizing your system and existing files and loading the StorageWorks software onto your hard disk.

Note

When ESA is connected to non-Digital platforms, connection to one host port per controller pair is supported.

The procedures for installing the StorageWorks software for IBM on AIX require that you be familiar with the System Management Interface Tool, (SMIT). See the “System Management Interface Tool” section in the *System Management Guide: Operating System and Devices* for more information on the use of SMIT.

Note

Prior to installing this software, make sure that the array controller write-back cache battery is fully charged. This is accomplished by supplying power to the array controller for a minimum of 6 hours.

5.7.1 Organizing Your System

For new installations, perform the following procedure prior to installing the StorageWorks software:

Caution

DO NOT plug the SCSI cable into the host connector at this time.

1. After installing the SCSI-2 Differential Fast/Wide Host Adapter, reboot the system without the SCSI cable connected to the RAID controller. When the "console login" prompt appears, log into the system as root.
2. Ensure that the SCSI-2 Differential Fast/Wide Host Adapter has been installed in the system and configured by typing the following command and verifying the resulting display:

```
# lsparent -C -k scsi_scb -H && lsparent -C -k scsi
```

The display is different for Micro Channel and PCI Bus Systems.

For MicroChannel bus systems, the following displays:

name	status	location	description
ascsi0	Available	00-05	Wide SCSI I/O Controller Adapter
ascsi1	Available	00-06	Wide SCSI I/O Controller Adapter
scsil	Available	00-07	SCSI I/O Controller
scsi0	Available	00-00-0S	Standard SCSI I/O Controller
vscsi0	Available	00-05-00	SCSI I/O Controller Protocol Device
vscsi1	Available	00-05-01	SCSI I/O Controller Protocol Device
vscsi2	Available	00-06-00	SCSI I/O Controller Protocol Device
vscsi3	Available	00-06-01	SCSI I/O Controller Protocol Device

On MicroChannel subsystems this command displays the SCSI adapters currently configured into the system. SCSI adapters with external SCSI expansion capability will have a -01 as the last field under the location column heading. If your system includes only one adapter with external expansion capability, then only one vscsi line will be displayed that contains a -01. If your system contains multiple adapters with external expansion capability, then multiple vscsi lines will be displayed as in the example above. If either no vscsi lines are displayed, or no vscsi line with a -01 location is displayed, then the operating system has not correctly configured the device. Recheck the hardware installation and retype this command.

Once you have determined that the vscsi device is configured correctly, check that the vscsi adapter with the -01 location is listed as "Available" in the status column. If the device is listed as "Defined" then the operating system has not correctly configured the device. In that case, recheck the hardware installation and retype the command shown at the beginning of Step 2.

For PCI bus systems, the following displays:

name	status	location	description
scsi0	Available	04-C0	Wide SCSI I/O Controller
scsi1	Available	04-02	Wide SCSI I/O Controller

On PCI bus systems this command displays the Wide SCSI I/O controllers currently configured into the system. If your system contains multiple controllers then a number of them will be listed. Ensure that the **all numeric location** field (for example, 04-02) corresponds to the slot where the Wide SCSI I/O controller (IBM FC2409) is installed and that the status field is listed as available.

If the device is not listed or is shown as *Defined*, then the operating system has not correctly configured the device. In that case, check the hardware installation and retype the command shown at the beginning of this Step 2.

3. Determine the following:
 - SCSI target address of your array controller configured.
 - Number of consecutive Logical Unit Numbers (LUNs) configured on the arraycontroller.
4. Check for previously installed StorageWorks software by typing:

```
# odmget -quniquetype=disk/scsi/HSZ50 PdDv
```
5. If you locate previously installed StorageWorks software (i.e., **odmget** command produces some output), delete the existing StorageWorks software using the following commands:

```
# odmdelete -o PdDv -q uniquetype=disk/scsi/HSZ50
# odmdelete -o PdAt -q uniquetype=disk/scsi/HSZ50
# odmdelete -o PDiagAtt -q DType=HSZ50
# odmdelete -o PDiagDev -q DType=HSZ50
# odmdelete -o errnotify -q en_rtype=HSZ50
```
6. Connect the SCSI cable from the host adapter to the array subsystem.

5.7.2 Installing the StorageWorks Software onto the Hard Disk

The StorageWorks software consists of the array software installation scripts and the AIX support files.

The StorageWorks software consists of:

- An installation and configuration script
- ODM database files
- ODM catalog files

5.7.2.1 Copying the File Archive from CD-ROM to Temporary Storage

Before running the installation or upgrade scripts, copy the file archive that contains the StorageWorks software from the CD-ROM to a temporary directory. The scripts can then be executed. You will need approximately 2 MBytes of temporary space to load the file archive from CD-ROM.

1. Insert the StorageWorks software distribution CD-ROM into the drive.
2. Login as root (superuser).
3. Change the directory to a temporary storage area (/tmp). For example, enter the following command:

```
# cd /tmp
```

4. Create a directory into which the file archive can be loaded with the following command:

```
# mkdir esa
```

5. Change to that directory using the following command:

```
# cd esa
```

6. Mount the CD-ROM using the following command:

```
# mount -vcdvfs -r /dev/cd0 /mnt
```

(Note: the name of /dev/cd0 may be different on your system.)

7. Extract the file archive from the CD-ROM by entering the following command:

```
# tar xvf /mnt/agents/aix/stm_aix.tar
```

8. All of the files necessary to complete the StorageWorks software installation have now been copied to this directory.

5.7.2.2 Executing the Installation Script

Perform the following procedure to install the StorageWorks software onto your system:

1. Enter the following command and press RETURN:

```
# ./stgwks_aix.sh
```

The installation options menu displays:

```
StorageWorks and Command Console Agent  
Installation and Configuration Menu
```

```
StorageWorks Options:  
-----
```

- ```
1) Install StorageWorks software
2) StorageWorks Maintenance
```

```
Agent Options:

```

- ```
3) Install Agent  
4) Agent Maintenance
```

```
Q) Quit  
Enter Selection: 1
```

2. Type 1 to install StorageWorks software. The Copyright Notice and the following information displays:

Copyright Digital Equipment Corp. 1994, 1995, 1996. All rights reserved.

Restricted Rights: Use, duplication by the U.S. Government is subject to restriction as set forth in subparagraph (c) (1) (ii) of DFARS 252.227-7013, or in FAR 52.227-19, or in FAR 52.227-14 Alt. III, as applicable

Portions of this software are proprietary to and embody the confidential technology of Digital Equipment Corporation. Possession, use, or copying of this software and media is authorized only pursuant to a valid written license from Digital or an authorized sublicensor.

```
Checking User...OK
Checking AIX Revision Level...OK
Checking that SCSI-2 Adapter is installed and correctly
configured...OK
Checking for previous SWXRC or HSZ50 software
installation...OKChecking for ODM add files...OK
Checking for 4.1 ODM add files...OK
Checking for ODM catalog files...OK
```

Once all of the checks have been successfully completed, you will be asked about the array controller configuration. In order for the system to recognize the devices attached to the array controller, the Target ID (TID) and at least one Logical Unit Number (LUN) must have been created on the array controller via the Command Line Interface (CLI). The system can correctly configure the array controller with multiple TIDs and multiple LUNs per TID subject to the following restrictions:

- LUNs must start with LUN 0
- LUNs created for each TID must be consecutive with no gaps
- When multiple TID's have been created, the same number of LUNs per TID must also have been created
- If your computer system is equipped with two RAID controller storage subsystems, the number of LUNs per TID configured on each subsystem must be the same
- If your computer system is equipped with multiple adapters, all of the restrictions above apply to each RAID subsystem attached to each adapter
- The following examples are allowable subsystem configurations as they will be correctly recognized and configured by the RS/6000:

- TID 4 and LUN 0
- TID 4 and LUN 0 and LUN 1
- TID 6 and LUN 0 and LUN 1 and LUN 2
- TID 4 and LUN 0, TID 6 and LUN 0

The following examples are illegal ESA subsystem configurations as they will not be correctly recognized and configured by the AIX:

- TID 4 and LUN 5 – AIX would create hdisk devices for TID 4, LUNs 0 through 5.
- TID 4 and LUN 5 and LUN 6 – AIX would create TID 4, LUNs 0 through 6.
- TID 6 and LUN 1 and LUN 4 and LUN 6 – AIX would create TID 6, LUNs 0 through 6.
- TID 4 and LUN 5, TID 6 and LUN 5 – AIX would create TID 4, LUNs 0 through 5, and TID 6, LUNs 0 through 5.
- TID 4 and LUN 0, TID 6 and LUN 0 and LUN 1 – AIX would create TID 4, LUNs 0 and 1, and TID 6, LUNs 0 and 1.

3. Answer the following prompt with the correct number of LUNs configured in your system and press RETURN.

```
Please enter the number of consecutive LUN's, 1..8, that
have been configured on the RAID Array: 5
```

For the correct examples previously listed, the answers to this question would be: 1, 2, 3 and 1.

4. After the correct number of LUNs is entered, the installation script verifies that the answer is within the range of 1 through 8 and continues execution until the following information is displayed (*Note: Processing time is approximately 2 minutes*):

```

Maximum LUNS configured = 5      ...OK
Editing ODM Database files...OK
Adding SWXRC-04 to ODM Database...OK
Adding HSZ50 to ODM Database...OK
Moving ODM Catalog into place...OK
Configuring RAID Array into system...OK
Saving base configuration...OK
Issuing bosboot command, please standby...OK
Copying installation files to /usr/stgwks directory...OK

```

RAID Array Configuration Information

```

-----
name status location description

hdisk2 Available      00-02-01-3,0      DEC HSZ50 RAID Array 450
hdisk3 Available      00-02-01-3,1 DEC HSZ50 RAID Array 450
hdisk4 Available      00-02-01-3,2 DEC HSZ50 RAID Array 450
hdisk5 Available      00-02-01-3,3 DEC HSZ50 RAID Array 450
hdisk6 Available      00-02-01-3,4 DEC HSZ50 RAID Array 450

```

This display lists the array controller devices that have been configured into the system and recognized by the operating system.

Now that the array controller is configured and the devices recognized by the operating system, the user is asked a series of questions regarding the use of those devices. Specifically, the user is asked whether to allow the script to create a default set of Logical Volume Group(s).

The installation script determines the maximum amount of storage provided by the current set of devices attached to the RAID controller. The script allows the user to choose the size of each file system. AIX version 4 restricts the size of file systems to 64 GBytes. Any storage space not allocated to a file system during the installation can be used to extend the file systems at a later date or create additional logical volumes.

If you are not familiar with the Logical Volume Manager and creation of a file system organization, answer "Y" in the following step. This allow the installation script to create the Logical Volume Groups, Logical Volumes, file systems, and mount points for the devices attached to the array controller. To utilize this option, all of the logical units must have already been created on the array controller with the CLI.

If you understand how to use the Logical Volume Manager to tailor the file systems to their requirements or intend to install the Command Console Client (GUI) and Agent to create additional Logical Units, answer "N" in the following step. This will cause the installation script to perform a small amount of cleanup and complete the installation, without creating any of the filesystem components necessary to utilize the devices in the ESA subsystem.

5. Enter the answer to the following prompt and press RETURN.

Please answer Y/N (Yes or No) to the following question.

Would you now like to create the Logical Volume Group(s) that will contain the RAID Array devices? If you are planning to use the Storage Works Command Console to create additional logical units then answer N(no). N

You are now ready to install the StorageWorks Command Console software. Proceed to Chapter 6 for these instructions.

5.8 Preparing Your Solaris System for ESA

This section describes the procedures for installing the required device drivers to establish communication between the controller and your Solaris operating system.

Note

When ESA is connected to non-Digital platforms, connection to one host port per controller pair is supported.

5.8.1 Installing DECptisp onto the Hard Disk

If you have not yet installed your host adapter, follow the procedures that came with your adapter and install it now.

Note

Skip this section if you are using the Sun SWIS/S X1062A adapter. Follow the procedures that came with your adapter to install the adapter and device driver, and to ensure that the adapter is available to the system, then proceed to Chapter 6 to install the StorageWorks Command Console software.

If you are using a DEC SBS-440/450 adapter, use the following procedure to install the DECptisp (SCSI adapter) driver.

1. Mount the CD-ROM
2. Add the DECptisp package

5.8.1.1 Mounting the CD-ROM

1. Check whether the volume management daemon (vold) is currently running. Enter the following command:

```
# ps -ea | grep vold
```
2. Follow the steps below for "**vold currently running**" or "**vold not currently running**," as applicable:

If vold is currently running, do the following:

- a) Insert the RAID Array 450 for Solaris CD-ROM into the CD-ROM drive.
- b) Check that the volume manager has automatically mounted the CD-ROM using the following command:

```
# mount
```

Note

The system may take a few seconds to mount the CD-ROM. If the mount command does not indicate that the CD-ROM has been mounted, wait a short interval and then repeat the command.

- c) Change to the Solaris-2 directory by entering the following command:

```
# cd /cdrom/stgwks450-v50-sun/agents/solaris
```

- d) Proceed to Section 5.6.3 to install the DECptisp.

If vold is not currently running

- a) Insert the RAID Array 450 for Solaris CD-ROM into the CD-ROM drive.

- b) Mount the CD-ROM. For example, enter the following command:

```
# mount -F hsfs -r /dev/dsk/c0t6d0s2 /cdrom
```

- c) Change to the Solaris-2 directory by entering the following command:

```
# cd /cdrom/stgwks450-v50-sun
```

- d) Now load DECptisp described in the next section.

5.8.1.2 Loading DECptisp

To install the SCSI host adapter driver files, DECptisp, follow these steps:

1. Enter the following command:

```
# ./install_stgwks
```

A menu appears listing the available packages. Enter **q** at any prompt if you want to quit this installation procedure.

2. Select the DECptisp package.

3. When the package installation completes, enter **q**. The *pkgadd* program prompts you to reboot your computer system.

4. To reboot, enter the following command:

```
# cd /  
# shutdown -y -i0 -g0
```

5. Wait for the "ok" boot prompt. Then enter the following command:

```
boot (your_system_boot_device_name)
```

When the Console Login prompt display, your drivers are installed.

You are now ready to install the StorageWorks Comand Console software. Proceed to Chapter 6 for these instructions.

5.9 Preparing Your Windows NT/Alpha System for ESA

This section describes how to install the required device drivers to enable communication between the ESA and your Windows NT/Alpha operating system.

Note

If you have not installed your KZPSA adapter, you must do so before installing the HSZDISK.SYS driver. Refer to Chapter 2 in the *Getting Started RAID Array 450 for Windows NT/Alpha Installation Guide* for detailed information about installing the adapter.

1. Locate the CD-ROM disk labeled *RAID Array 450 for Windows NT/Alpha*. It contains the *HSZDISK.SYS* driver.
2. Insert the *RAID Array 450 for Windows NT* CD-ROM into your CD-ROM drive.
3. From Windows NT, click on command prompt in the **Main** program group.
4. Type the drive letter corresponding to your CD-ROM drive (e.g., **D:**).
5. Change to the *alpha* sub-directory by typing the following command:

```
CD\drivers\NTxxx\alpha
```

where: xxx = 3.51 or 4.0

6. Type the following command:

```
hszinst1 drive_letter:\NT_root_directory
```

where:

“drive_letter” and “NT_root_directory” correspond to the root path of your Windows NT system files on your system (e.g., `hszinst1 c:\winnt35`).

The installation process copies the driver into the correct subdirectory and creates the necessary Registry entries.

You are now ready to install the StorageWorks Command Console software. Proceed to Chapter 6 for these instructions.

Note

After installing SWCC, go to Chapter 4 in the *Getting Started RAID Array 450 for Windows NT/Alpha Installation Guide* to complete your installation under Windows NT. This ensures that the disks are available to the Windows NT host.

5.10 Preparing Your Windows NT/Intel System for ESA

This section describes how to install the required device drivers to enable communication between the ESA and your Windows/Intel operating system.

Note

If you have not installed your host SCSI adapter, you must do so before installing the HSZDISK.SYS driver. Refer to Chapter 2 in the *Getting Started RAID Array 450 for Windows NT/Intel Installation Guide* for detailed information about installing the adapter.

1. Locate the CD-ROM disk labeled *RAID Array 450 for Windows NT*. It contains the *HSZDISK.SYS* driver.
2. Insert the *RAID Array 450 for Windows NT* CD-ROM into your CD-ROM drive.
3. From Windows NT, click on command prompt in the **Main** program group.
4. Type the drive letter corresponding to your CD-ROM drive (e.g., **D:**).
5. Change to the *i386* sub-directory by typing the following command:

```
CD\drivers\NTxxx\i386
```

where: xxx = 3.51 or 4.0

6. Type the following command:

```
hszinst1 drive_letter:\NT_root_directory
```

where:

“drive_letter” and “NT_root_directory” correspond to the root path of your Windows NT system files on your system (e.g., `hszinst1 c:\winnt35`).

The installation process copies the driver into the correct subdirectory and creates the necessary Registry entries.

You are now ready to install the StorageWorks Command Console software. Proceed to Chapter 6 for these instructions.

Note

After installing SWCC, go to Chapter 4 in the *Getting Started RAID Array 450 for Windows NT/Alpha Installation Guide* to complete your installation under Windows NT. This ensure that the disks are available to the Windows NT host.

Installing the StorageWorks Command Console

This chapter describes the StorageWorks Command Console (SWCC) program and the procedures for installing the SWCC. SWCC is a feature-rich, graphical user interface (GUI) and remote management program for StorageWorks controllers. It provides an extremely user-friendly method of monitoring, configuring, and troubleshooting your ESA.

6.1 Major Features

The SWCC has the following major features:

- High and low-level status monitoring of the storage subsystem using colored icons
- Graphical view of the controller and its physical and logical storage elements
- Host port SCSI bus virtual terminal connection to the storage array
- Automatic event logging in Windows NT® Version 3.51
- Graphical configuration of the storage array
- Network connection via TCP/IP protocol
- User and feature access protection
- Remote fault notification by pager

6.2 Program Modules

The SWCC consists of two program modules:

- SWCC client is the GUI portion of SWCC. The client is a 32-bit application designed to run on Microsoft Windows NT[®] Version 3.51 and Windows 95[®] systems.
- SWCC agent is a host agent program that works with the client for network connectivity. For detailed information, refer to the applicable agent user's guide (all SWCC documentation is located on the SWCC CD-ROM).

The SWCC modules are referred to as the *client* and the *agent*. The term *SWCC* refers to both client and agent working together.

6.3 RAID Support and Terminology

The SWCC supports the following RAID configurations:

- RAID 0—RAID 0 is the industry standard for striping. A single logical disk spans multiple physical disks. This is the only RAID level that does not provide redundancy. The client uses the term *stripeset* for a RAID 0 volume available to the host.
- RAID 1—A single logical disk replicated on two or more physical disks. The mirroring technique provides data redundancy. The client uses the term *mirrorset* for a RAID 1 volume available to the host.
- RAID 0+1—Combines the striping of RAID 0 and the shadowing/mirroring of RAID 1, to provide the best combination of very good performance and high availability. The client uses the term *striped mirrorset* for a RAID 0+1 volume available to the host.
- RAID 3/5—Stripes and distributes parity chunks across all members in the array. RAID 3/5 is the best choice for most applications with small to medium input/output requests *unless* the application is write-intensive. The client uses the term *RAIDset* for a RAID 3/5 volume available to the host.

6.4 Client System Requirements

SWCC connects to StorageWorks HSZ-series controllers. The TCP/IP connection must be in operation before the program begins to issue commands and interpret the responses sent by the controller. The user interface displays in graphical form the logical and physical layout, and status of a selected subsystem.

Table 6-1 outlines the *minimum* system configuration needed to run client.

Table 6-1 Minimum PC System Configuration Requirements

Feature	Minimum Requirements
PC CPU Speed Memory	Intel 486 66 MHz 16 MB
Free Disk Space	10 MB
Operating System	Windows NT 3.51 (Build 1057 or later) or Windows 95 (Build 950 or later)
Display Size Type Resolution	15" VGA 800 x 600
Input Devices	CD-ROM Keyboard Mouse
Modem	Hayes compatible
Network Adapter	TCP/IP Compatible

6.5 Installing the SWCC

The following steps are required to install the StorageWorks Command Console and are **shown here for reference only**: Please refer to the *Getting Started with Command Console* document for details about each step.

1. Install the Adobe Acrobat Reader so you can view the documentation on the accompanying CD-ROM.
2. Access the documentation on the accompanying CD-ROM.
3. Read the release notes on the CD-ROM.
4. Choose either a local or network connection for the client.
5. Install the client software on your local system.
6. If you choose the network connection method, install the agent software in your hosts.

Refer to the StorageWorks Command Console CD-ROM online documentation for instructions on installing the agent software specific to your operating system.

Note

During installation of the Agent, the manufacturer of all Agents is Digital.

6.6 Agent Connection Licensing

The network version of Client comes with a built-in license to connect to one Agent program. If you wish to run the network version of the product with more than one Agent, you must enter a license number that determines the number of Agents to which you can connect Client. The first three digits of the license number indicate the number of Agent connections allowed by the license.

When you run the network version of Client for the first time after it is installed, and you wish to connect to more than one Agent, you must enter your license number into Client's licensing facility. To enter your license, do the following:

1. Select the *License Upgrade* option from the *Settings* menu.
2. Enter the three-digit prefix of your license, followed by a 20-digit numeric string. Your number can be found on a sticker on the outside of the StorageWorks Command Console CD-ROM.
3. Click *OK* after you have entered and checked your full license number.

If you wish only to connect to one Agent, you do not need to enter a license number.

6.6.1 Installing Additional Agents

You may want to install Agents on your other host systems. To install more Agent programs, simply repeat the procedure above, using the appropriate host system name and Agent type for each session.

Remember to check your license before you add additional Agents. If you exceed the number of Agent connections allowed by your license, you must purchase a license upgrade.

6.7 Next Steps

You have successfully completed all the procedures necessary to install the ESA.

You are now ready for the Multivendor Customer Service Integration organization to configure your system.

Glossary

ac power supply

A power supply designed to produce dc power from an ac input.

American National Standards Institute

See ANSI.

ANSI

American National Standards Institute. An organization that develops and publishes electronic and mechanical standards.

blower

An airflow device mounted in a StorageWorks shelf.

cable distribution unit

See CDU.

carrier

A standard, StorageWorks shelf-compatible, plastic shell into which a device can be installed. Sometimes called SBB carrier.

CDU

Cable distribution unit. The power entry device for StorageWorks cabinets. The unit provides the connections necessary to distribute ac power to cabinet shelves and fans.

controller

A hardware/software device that facilitates communications between a host and one or more devices. A controller translates bus protocols and hardware interfaces and adds functionality to the host/device communications.

data center cabinet

A generic reference to the large cabinets, such as the cabinet in which StorageWorks enterprise storage array components are mounted.

ECB

A External Cache Battery. A device housed in a standard StorageWorks SBB carrier that mounts in a SBB shelf. It provides cache backup power to the controller cache module.

fan

An airflow device mounted in a StorageWorks cabinet.

filler panel

A sheet metal or plastic panel used to cover unused mounting areas in StorageWorks cabinets and shelves.

host

The primary or controlling computer to which a storage subsystem is attached.

redundant

A configuration in which there is backup hardware in place for the hardware that is present.

SBB

StorageWorks building block. A device housed in a standard StorageWorks SBB carrier. An SBB has a standard physical and electrical interface that is compatible with those of StorageWorks shelves and enclosures.

SBB shelf

StorageWorks building block shelf. A StorageWorks shelf, such as the BA350–Sx, designed to house plug-in SBB modules.

SCSI

Small Computer System Interface. An ANSI interface defining the physical and electrical parameters of a parallel I/O bus used to connect hosts to a maximum of seven devices. The StorageWorks device interface is implemented according to the SCSI-2 standard, allowing the synchronous transfer of 8-bit data at rates of up to 10 MB/s.

skirt

A trim panel designed to mount around the base of the cabinet.

Small Computer System Interface

See SCSI.

StorageWorks

Digital's family of modular data storage products that allows customers to design and configure their own storage subsystems. Components include power, packaging, cabling, devices, controllers, and software. Customers can integrate devices and array controllers in StorageWorks enclosures to form storage subsystems.

StorageWorks building block

See SBB.