

DEClaser 2100 Printer
Service Guide

EK-LN05X-SV .001

DEClaser 2100 Printer Service Guide

EK-LN05X-SV-001

**Digital Equipment Corporation
Maynard, Massachusetts**

First Printing, September 1990

The information in this document is subject to change without notice and should not be construed as a commitment by Digital Equipment Corporation.

Digital Equipment Corporation assumes no responsibility for any errors that may appear in this document.

Any software described in this document is furnished under a license and may be used or copied only in accordance with the terms of such license. No responsibility is assumed for the use or reliability of software or equipment that is not supplied by Digital Equipment Corporation or its affiliated companies.

Restricted Rights: Use, duplication, or disclosure by the U.S. Government is subject to restrictions as set forth in subparagraph (c)(1)(ii) of the Rights in Technical Data and Computer Software clause at DFARS 252.227-7013.

© Digital Equipment Corporation 1990
All rights reserved. Printed in U.S.A.

The Reader's Comments form at the end of this document requests your critical evaluation to assist in preparing future documentation.

The following are trademarks of Digital Equipment Corporation: DECdirect, DEClaser, DECmate, DECserver, DECstation, MicroVAX, PrintServer, PRO, Rainbow, ReGIS, VAX DOCUMENT, VAXstation, VT, and the DIGITAL Logo.

The following are third-party trademarks: Centronix is a trademark of Centronix Data Computer Corporation. IBM-PC is a trademark of International Business Machines Corporation. PostScript is a registered trademark of Adobe Systems, Inc. Tektronix is a registered trademark of Tektronix, Inc.

S1386

This document was prepared using VAX DOCUMENT, Version 1.2.

Contents

Preface

ix

Chapter 1 DEClaser 2100 Physical and Functional Description

1.1	Description of the DEClaser 2100 Printer	1-1
1.1.1	Printer Components	1-2
1.2	Paper Cassettes and Manual Feeders	1-8
1.3	Output Stacks and Paper Paths	1-9
1.3.1	Paper Paths	1-10
1.3.2	Paper Path and Jam Detection Sensing	1-11
1.4	Electronic Block Diagrams	1-11
1.4.1	I/O Board	1-13
1.4.2	Video Control Board	1-13
1.4.3	DC Control Board Signals	1-15
1.4.4	LVPSA, Main Motor, and Interlock Diagram	1-18
1.4.5	Fixing Heater Control Circuit	1-18
1.4.6	HVPSA Circuits	1-21

Chapter 2 DEClaser 2100 Control Panel Operation

2.1	Control Panel Keys and Indicators	2-1
2.1.1	Control Panel Indicators	2-1
2.1.2	Control Panel Keys	2-3
2.2	Setup Menu Operation	2-5
2.2.1	Setup Menu Format	2-7
2.2.2	Moving, Selecting, and Saving Values	2-7
2.3	Test Patterns	2-14
2.3.1	Test Print A	2-14
2.3.2	Font List	2-16
2.3.3	Test Print B	2-18

2.3.4	Engine Test Print	2-20
2.4	Control Representation (Character Dump) Mode	2-23

Chapter 3 DEClaser 2100 Troubleshooting

3.1	Getting Started	3-1
3.2	Troubleshooting Power-Up Faults	3-3
3.3	Troubleshooting Control Panel Faults	3-5
3.3.1	Status Messages and Faults	3-5
3.3.2	Operator Call Messages and Faults	3-7
3.3.3	Functional Messages and Faults	3-13
3.3.4	Service Messages	3-16
3.4	Troubleshooting Paper Jam and Feed Faults	3-22
3.4.1	Jam Troubleshooting Start FIP	3-22
3.4.1.1	Paper Path Jam Areas	3-24
3.4.2	Power-Up Jams	3-25
3.4.3	Area 1 Jams	3-26
3.4.4	Area 2 Jams	3-30
3.4.5	Area 3 Jams	3-33
3.5	Troubleshooting Image Defects	3-36

Chapter 4 DEClaser 2100 Removal and Replacement Procedures and RSL

4.1	Recommended Spares List (RSL)	4-1
4.2	Top Cover	4-3
4.2.1	Top Cover Mirror	4-6
4.2.2	Top Cover Switch Lever	4-11
4.3	Ozone Filter	4-12
4.4	Upper Cover	4-13
4.4.1	Front Subpanel	4-17
4.5	Bottom Cover	4-20
4.5.1	Font Cartridge Guides	4-22
4.6	EP-S Cartridge	4-23
4.7	Input/Output (I/O) Board	4-24
4.8	Video Control Board	4-26

4.8.1	Page Count IC	4-28
4.9	RAM Expansion Board	4-29
4.10	DC Control Board	4-30
4.11	Control Panel	4-34
4.12	High-Voltage Power Supply Assembly (HVPSA)	4-35
4.13	Low-Voltage Power Supply Assembly (LVPSA)	4-37
4.13.1	Solenoid and Sensor Board	4-40
4.14	Scanner Assembly	4-43
4.15	Feed Guide Assembly	4-45
4.16	Fixing Unit	4-46
4.17	Transfer Drive Assembly	4-50
4.17.1	Separation Pad	4-52
4.18	Transfer Corona Assembly	4-53
4.19	Preconditioning Lamp	4-54
4.20	Pickup Roller Assembly	4-57
4.21	Intermediate Gear Assembly	4-60
4.21.1	Inside OPC Drum Drive Gear	4-62
4.22	Output Roller Assembly	4-64
4.22.1	Output Roller Drive Gears	4-68
4.23	AC Inlet Assembly	4-69
4.24	Main Fan (FM1)	4-70
4.25	Fan (FM2)	4-72
4.26	Main Motor Assembly	4-73
4.26.1	Main Motor Drive (Gears)	4-74
4.27	Paper Pressure Assembly	4-75

Appendix A DEClaser 2100 General Information

A.1	Macro Numbers	A-1
A.2	Interface Interconnections	A-2
A.2.1	Parallel Port	A-2
A.2.2	Serial Port	A-3
A.3	Interface Cables and Adapters	A-3

Appendix B DEClaser 2100 Specifications

B.1	Print Media	B-1
B.1.1	Paper Handling and Storage	B-1
B.1.2	Acceptable Paper	B-2
B.1.3	Envelopes	B-4
B.1.4	Transparencies	B-4
B.2	Labels	B-5
B.3	Operating Specifications	B-6

Appendix C DEClaser 2100 Total Call Concept (TCC)

C.1	Performing TCC	C-1
C.2	Maintenance Log	C-1
C.3	100K PM Procedure	C-2
C.4	TCC Procedure	C-2
C.4.1	External Cleaning	C-3
C.4.2	Internal Cleaning and Inspection	C-3

Figures

1-1	Components: Right-Side View	1-2
1-2	Components: Rear View	1-4
1-3	Components: Inside the Printer	1-6
1-4	Cassette and Manual Feeder Top	1-8
1-5	Output Stacks	1-9
1-6	2100 Paper Paths	1-10
1-7	2100 Overall Block Diagram	1-12
1-8	Video Control Board	1-13
1-9	2100 DC Control Board Input Signals	1-15
1-10	2100 DC Control Board Output Signals (Part 1)	1-16
1-11	2100 DC Control Board Output Signals (Part 2)	1-17
1-12	LVPSA Block Diagram	1-18
1-13	Fixing Heater Diagram	1-19
1-14	HVPSA Connector Block	1-22
1-15	HVPSA Image Circuits	1-23
2-1	Control Panel Indicators	2-2

2-2	2100 Keypad Keys	2-4
2-3	2100 Keypad Operation	2-6
2-4	Setup Menu Display Text	2-7
2-5	Test Print A	2-15
2-6	Font List	2-17
2-7	Test Print B	2-19
2-8	Pressing the Test Button	2-21
2-9	Engine Test Print	2-22
3-1	Start FIP	3-2
3-2	Power-Up Fault	3-4
3-3	Jam Start FIP	3-23
3-4	2100 Jam Areas	3-24

Tables

1-1	Printer Components: Right-Side View	1-3
1-2	Printer Components: Rear View	1-5
1-3	Printer Components: Internal View	1-7
2-1	Control Panel Indicators	2-2
2-2	Offline Ready Keys	2-4
2-3	Menu Scrolling Keys	2-7
2-4	2100 Setup, Feature, and Value Menus	2-8
3-1	Operational Status Messages	3-6
3-2	Operator Call Messages	3-7
3-3	Functional Messages	3-13
3-4	Service Messages	3-16
3-5	Power-Up Jams	3-25
3-6	Area 1 Jams	3-27
3-7	Area 2 Jams	3-31
3-8	Area 3 Jams	3-34
3-9	Image Defect Lookup Table	3-36
4-1	DEClaser 2100 Recommended Spares List (RSL)	4-1
A-1	User Preference Character Sets	A-1
A-2	Parallel Interface Pin Assignment	A-2
A-3	Serial Interface	A-3
A-4	Cables and Adapters	A-4
B-1	Available Cassettes	B-2

B-2	Paper Specifications	B-3
B-3	Transparency Sizes	B-4
B-4	Transparency Specifications	B-5

Preface

About This Service Guide

This book is intended to assist the Customer Services engineer (CSE) to repair and service the DEClaser 2100 printer in the field environment.

- Chapter 1, DEClaser 2100 Physical and Functional Description, describes the printer, the controls, and the input and output paper handling devices. It also contains an overall description of the electronics.
- Chapter 2, DEClaser 2100 Control Panel Operation, describes the control panel operation, the setup menus, and the onboard test patterns.
- Chapter 3, DEClaser 2100 Troubleshooting, provides the fault isolation procedure (FIP) that you use to find a malfunctioning field replaceable unit (FRU) and to repair the printer.
- Chapter 4, DEClaser 2100 Removal and Replacement Procedures and RSL, provides instruction on how to remove and replace the major assemblies within the DEClaser 2100 printer.
- Appendix A, DEClaser 2100 General Information, contains additional information about the DEClaser 2100 printer.
- Appendix B, DEClaser 2100 Specifications, gives print media and operational specifications.
- Appendix C, DEClaser 2100 Total Call Concept (TCC), is the Total Call Concept (TCC) procedure for the DEClaser 2100 printer.

DEClaser Training

Before attempting to use the book and repair the printer, you must attend the specific DEClaser Educational Services training course and all other prerequisite training courses. The following table gives the ordering numbers and information about the courses.

Number	Description
EY-7629E-IV	Hardcopy and video specialist core course.
EY-5528E-IV	Laser safety and printer concepts course.
EY-F413E-P0	DECLaser SPI/lab training course is offered at FTC A and B sites worldwide.

Conventions

The following conventions are used throughout this document:

Convention	Description
Note	Notes provide additional information.
Caution	Cautions emphasize information for preventing damage to equipment.
Warning	Warnings emphasize information for prevention of personal injury.
Feeder Select	A box is used to indicate console or keyboard keys. All control panel keys are described in Chapter 2.

Tools

The following table lists the ordering number of the tools that are needed to service the DECLaser 2100 printer in the field.

Number	Description
29-26106-00	50-Hz terminal tool kit
29-26109-00	60-Hz terminal tool kit
29-11762-00	Antistatic kit
29-26259-00	Vacuum ¹ and attachments, 200 volts
29-25526-00	Vacuum ¹ and attachments, 120 volts
29-26017-00	Filter bags and filter shell
29-26234-00	Cleaning kit
29-27340-01	Terminal tool kit

¹Special vacuum for cleaning up toner powder.

Number	Description
29-25290	Phillips #2 long shank screwdriver. This tool is part of the PrintServer 40 special maintenance tools. If the recommended screwdriver is unavailable, any #2 Phillips screwdriver with a shank longer than 6 in. (152.4 mm) can be used in its place.

Documentation Ordering Information

The following table lists the ordering numbers for this service guide and for other related DEClaser 2100 documentation.

Number	Description
EK-LN056-DK ¹	<p>The DEClaser 2100/2200 Service Guide Documentation Kit includes the following items.</p> <ul style="list-style-type: none"> • <i>DEClaser 2100 Printer Service Guide</i> • <i>DEClaser 2200 Printer Service Guide</i> • Three-ring, 7x9 inch binder • Spine insert • Insert in binder pouch
EK-D2100-DK ¹	<p>The DEClaser 2100 User Documentation Kit consists of the following items.</p> <ul style="list-style-type: none"> • <i>DEClaser 2100 Printer Installation Guide</i> • <i>DEClaser 2100 Printer Operator's Guide</i> • Three-ring, 7x9 inch binder • Spine insert
EK-D2122-IP	<i>DEClaser 2100/2200 Illustrated Parts Breakdown</i>
AA-PBWGA-TE	<p><i>Digital ANSI-Compliant Printing Protocol Level 3 Programming Reference Manual</i></p> <p>Programmers use this manual to create applications for specific Digital ANSI-Compliant Printing Protocol level 3 devices and for descriptions of the protocol character processing and printer control functions.</p>

¹ You must order the documentation set.

Number	Description
AA-PBWHA-TE	<p><i>Digital ANSI-Compliant Printing Protocol Level 3 Programming Supplement</i></p> <p>Programmers use this manual to create applications for specific Digital ANSI-Compliant Printing Protocol level 3 devices and for converting ANSI output code to Digital PostScript page description language code.</p>
AA-PBWFA-TE	<p><i>PostScript Translators Reference Manual for ReGIS and Tektronix 4010/4014</i></p> <p>This manual is for programmers who need to convert ReGIS or Tektronix 4010/4014 documents to PostScript for printing on PostScript printers.</p>
EK-LASER-GD	<p><i>Digital Laser Printers Guide to Paper and Other Media</i></p> <p>This manual is for general users and contains detailed information about buying and storing print media (paper, envelopes, labels, and transparencies) that can be used with Digital's laser printers.</p>

Safety Information

The DEClaser 2100 printer complies with all United States government safety regulations applicable to ozone gas emissions and laser beam light exposure. Read the following information to become familiar with ozone and laser safety.

Ozone Safety Ozone is a colorless gas (O₃) that is a by-product of the electrophotographic process. The DEClaser printers use an ozone filter to remove the ozone generated by the printer. The ozone filter is replaced at 100,000-page intervals.

WARNING: *Be sure to replace the ozone filter every 100,000 pages and never operate the printer without the ozone filter in place. The filter removes ozone that could be hazardous to your health.*

Laser Safety The DEClaser 2100 printer complies with 21 CFR Chapter 1, Subchapter J, as a Class 1 laser product under the U.S. Department of Health and Human Services (DHHS) Radiation Performance Standard, according to the Radiation Control for Health and Safety Act of 1968. The DEClaser 2100 does not emit hazardous light since the laser beam is totally enclosed during all modes of customer operation and maintenance.

WARNING: *Use of controls or adjustment procedures other than those specified in this manual may result in hazardous laser light exposure.*

Chapter 1

DEClaser 2100 Physical and Functional Description

1.1 Description of the DEClaser 2100 Printer

This chapter gives a physical and functional description of the DEClaser 2100 printer.

The DEClaser 2100 printer uses electrophotographic laser technology to print text and graphics at speeds up to 8 pages/minute with a density of 300 x 300 dots/inch. The printer consists of an engine (print mechanism) and a controller (formatter) that are driven from host-based software to provide printer access from the Digital network.

Some of the features and options of the DEClaser 2100 printer include:

- Capacity for two external (optional) font cartridges
- Font downline loading capability
- Support for both serial and parallel interfaces
- Convenient user maintenance (one replaceable supply cartridge)
- Ability to print on envelopes
- Manual feeding capability
- A 1-, 2-, or 3-MB user-installable memory expansion
- PostScript (font) cartridge that converts the printer to a PostScript printer
- Font cartridges
- Envelope and paper cassettes

1.1.1 Printer Components

Figure 1-1 uses numbered callouts to identify the location of the operational components that are visible from the right side of the printer. For a description of each numbered element, refer to Table 1-1.

Figure 1-1: Components: Right-Side View

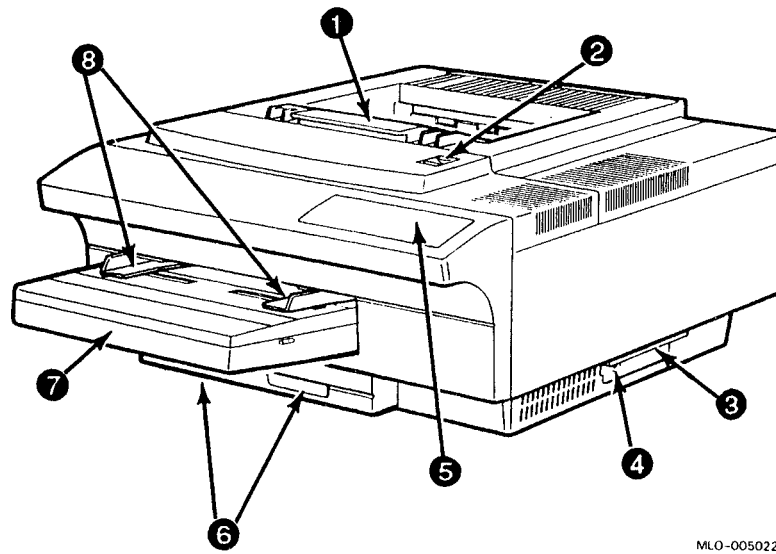
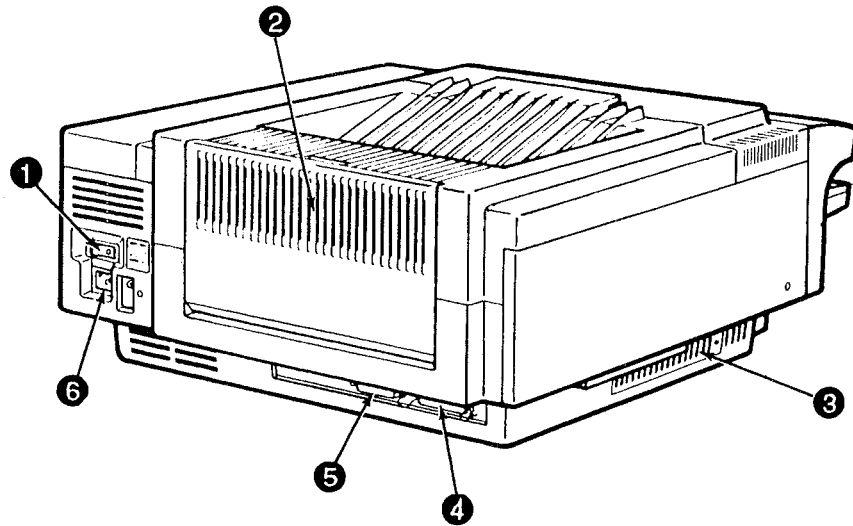

Table 1–1: Printer Components: Right-Side View

Component	Function
❶ Facedown (top) output tray	Printed sheets are automatically collated and stacked (facedown) here.
❷ Top cover release button	Pressing this button unlocks the top cover so it can be opened. Open the top cover to perform certain printer functions such as adding a new EP-S cartridge or clearing a paper jam.
❸ Carrying grip	A carrying grip is located on the right and left side of the printer.
❹ TEST PRINT button	This button prints the Engine Test Print. Use a pencil or suitable tool to press the TEST PRINT button. Refer to Section 2.3.4 for information about printing the Engine Test Print.
❺ Control panel	The control panel consists of a message display, indicator lights, and a keypad. See Chapter 2 for additional information about using the control panel.
❻ Font cartridge slots	These two slots accept the optional font cartridges available for the printer.
❼ Paper cassette	The paper cassette automatically feeds paper to the printer. It can hold up to 200 sheets of 21 lb (80 g/m ²) basis weight paper. See Section 1.2 for more information about the cassettes.
❽ Manual feed guide	The manual feed guide is part of the paper cassette cover. The feed guide allows you to manually feed paper, envelopes, transparencies, and labels into the printer. See Section 1.2 for more information about the cassette and manual feeders.

Figure 1-2 uses numbered callouts to identify the location of the operational components that are visible from the rear of the DEClaser 2100 printer. For a description of each numbered component, refer to Table 1-2.

Figure 1-2: Components: Rear View



MLO-004827

Table 1-2: Printer Components: Rear View

Component	Function
① Power switch	Powers the printer on or off. To ensure that data is not lost, always be sure the display reads 00 READY before you power off the printer.
② Faceup (rear) output stack, shown closed	Printer media is automatically directed into the faceup stack, when the faceup stack is pulled open. Select the rear output tray when you are printing transparencies, envelopes, or labels. You can also use it when you want printed output stacked faceup.
③ Memory board access cover	Additional RAM (random access memory) can be added to the printer in 1-, 2-, or 3-MB capacities. Remove the access cover to install the extra memory board. Refer to the documentation that comes with the optional memory boards for installation instructions.
④ Parallel (Centronics) interface connector	This connector accepts a 32-pin cable and is used for parallel interfacing to a host computer system. The connector is physically and electrically compatible to the Centronix protocol.
⑤ Serial (RS232) interface cable connector	Use this connector to plug in the serial interface cable from the host or communication equipment.
⑥ Power cord connector	This receptacle connects the power cord to the printer.

Figure 1-3 uses numbered callouts to identify the location of the operational components inside the printer. For a description of each numbered callout, refer to Table 1-3.

Figure 1-3: Components: Inside the Printer

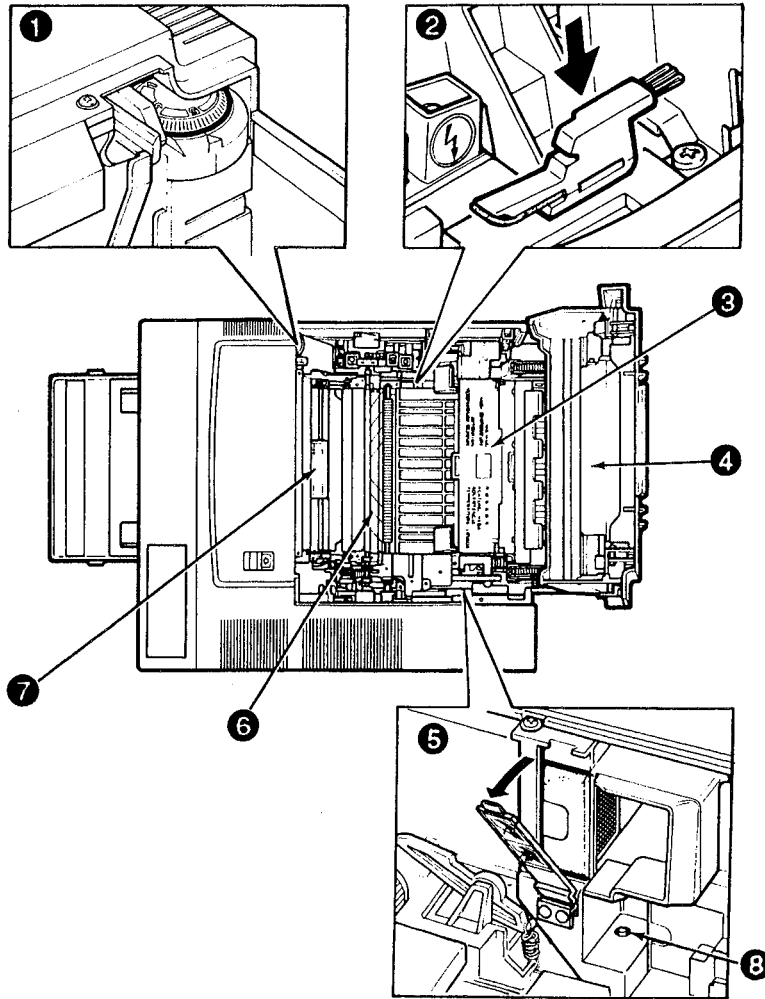

MLO-005009

Table 1-3: Printer Components: Internal View

Component	Function
① Print density dial	The dial has a range of 1-9 to adjust the print density. Selecting the lower numbers results in heavier or darker print density and increases toner consumption. Although the detent action sets the dial to the 5 position, the 7 position is recommended for normal operation.
② Cleaning brush	The (green) cleaning brush has two cleaning surfaces: the brush end, which is used to clean the discharging pins on the transfer corona assembly; and the fabric end, which is used to clean the primary corona wire in the EP-S cartridge.
③ Fixing unit	The fixing unit consists of a heat roller, a pressure roller, and a roller cleaner. The roller cleaner is a felt pad that cleans the fixing or heat roller and is replaced when the EP-S cartridge runs out of toner.
④ EP-S cartridge	EP-S stands for electrophotographic supply. The EP-S cartridge contains a photo-sensitive drum, the primary charge corona wire, a drum cleaning blade, toner, and a toner application roller. The EP-S cartridge is replaced when the TONER LOW message is displayed on the control panel.
⑤ Ozone filter	The ozone filter is replaced every 100,000 pages. WARNING: <i>Do not operate the printer without the ozone filter in place. The filter removes ozone that is generated by the printer.</i>
⑥ Transfer corona assembly	The transfer corona (charger) assembly contains the transfer charge wire and static eliminator.
⑦ Paper transfer guide assembly and registration rollers	The assembly consists of the registration rollers and upper cassette paper guide. Lifting the green handle causes the registration rollers to separate, releasing the sheet of paper and easing the removal of jammed paper.
⑧ CB101 reset button	The CB101 reset button pops up when circuit breaker CB101 opens. When the reset button pops up, press it down to reset the CB101. If the reset button pops up again, go immediately to Figure 3-1 to start troubleshooting the power-up fault. CB101 is shown in the circuit diagrams in Figure 1-12 and Figure 1-13.

1.2 Paper Cassettes and Manual Feeders

Four standard-sized paper cassettes are available. Each cassette holds up to 200 sheets of 21-lb (80-g/m²) basis weight media. The cassette size is fixed and cannot be configured to hold a different size media. Table B-1 describes the labeling and size of each cassette.

Figure 1-4 shows the cassette and the following components:

- ❶ The printer reads the molded cassette key to determine the size of the media in the cassette.
- ❷ The clear top of the cassette sits securely in alignment holes.
- ❸ The adjustable guides on the cassette top are used to manually feed media into the printer.

Figure 1-4: Cassette and Manual Feeder Top

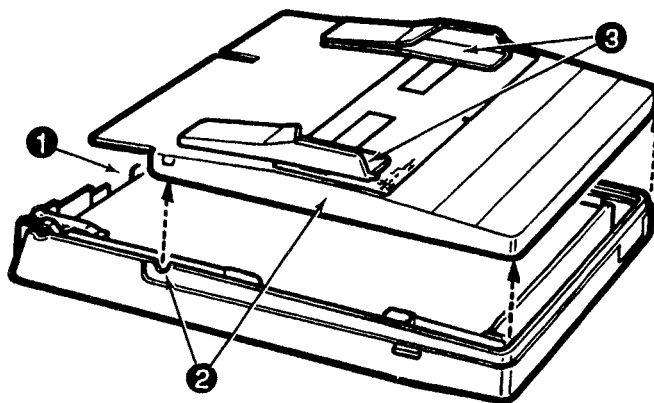

When a cassette is inserted into the empty cassette slot, the following actions occur:

- The foot lever moves the pressure pad down, then up. This action positions the pressure pad for best operation. The pressure pad eliminates multiple feeding.

- The cassette pushes a lifting lever that moves the spring tension pressure lever. The pressure lever lifts and presses the paper stack into the feed roller.
- The cassette key actuates the size-sensing switches in the cassette slot.

Envelope Cassette

The special envelope cassette holds up to 15 envelopes. See Appendix B for more media specifications.

NOTE: *You cannot attach the optional envelope feeder used on the DEClaser 2200 printer to the DEClaser 2100 printer.*

1.3 Output Stacks and Paper Paths

Figure 1-5 shows the faceup and facedown printout stacking trays on the DEClaser 2100 printer.

The faceup stack is necessary when printing media, such as envelopes, labels, or heavy stocks that are too stiff to bend around the turn leading to the facedown tray.

Figure 1-5: Output Stacks

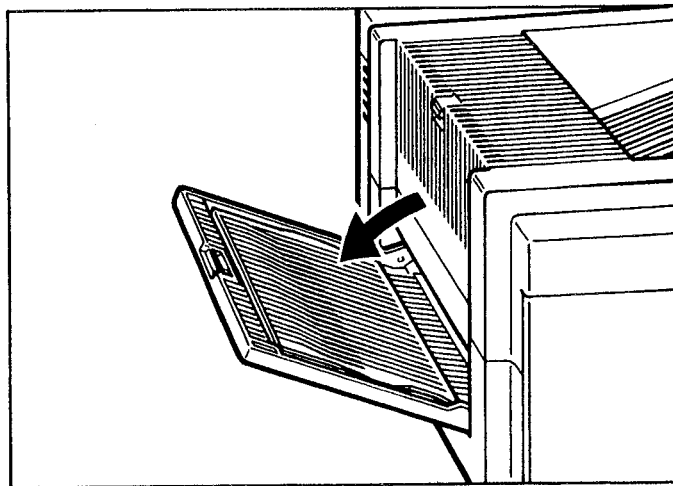

MLC-004835

1.3.1 Paper Paths

Figure 1-6 shows the faceup and facedown paper paths. Mechanical linkages on the faceup (rear) output tray door set the fork gate to direct paper into the faceup (rear) stack as the paper is ejected by the fixing unit rollers.

Figure 1-6: 2100 Paper Paths

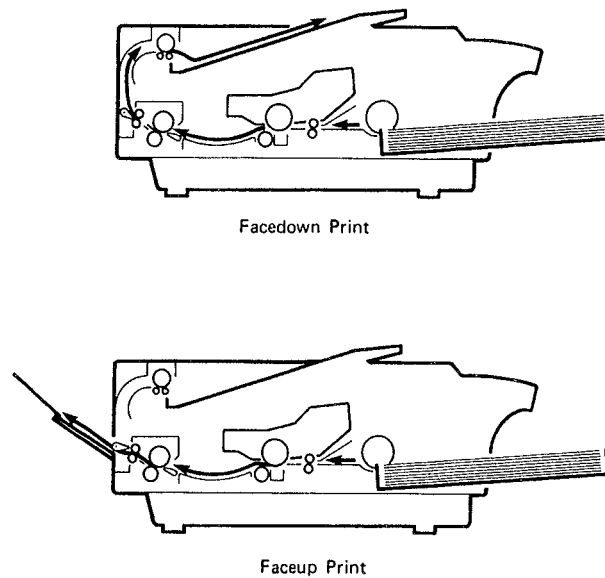

MLO-004832

1.3.2 Paper Path and Jam Detection Sensing

The fixing unit exit sensor detects all jams in the DEClaser 2100 printer. The dc control board monitors the exit sensor during power-up and at specific times during the print cycle. If paper is detected immediately after power-up, the printer does not warm up, display READY, or go on line. The printer can be powered up and display READY with paper in the paper path, but not if the paper is under the exit sensor.

During the print cycle, the dc control board compares the timing and sensor events to track the media as it travels through the paper path. The print cycle is initiated when a sheet of paper, or suitable media, is fed into the paper path; the cycle ends at the selected output stack. If the leading or trailing edge of the media fails to actuate the exit sensor within the expected time period, the dc control board shuts down the fixing unit heater and beeps the control panel alarm.

1.4 Electronic Block Diagrams

Figure 1-7 shows the major electronic components that operate the DEClaser 2100 printer.

Figure 1-7: 2100 Overall Block Diagram

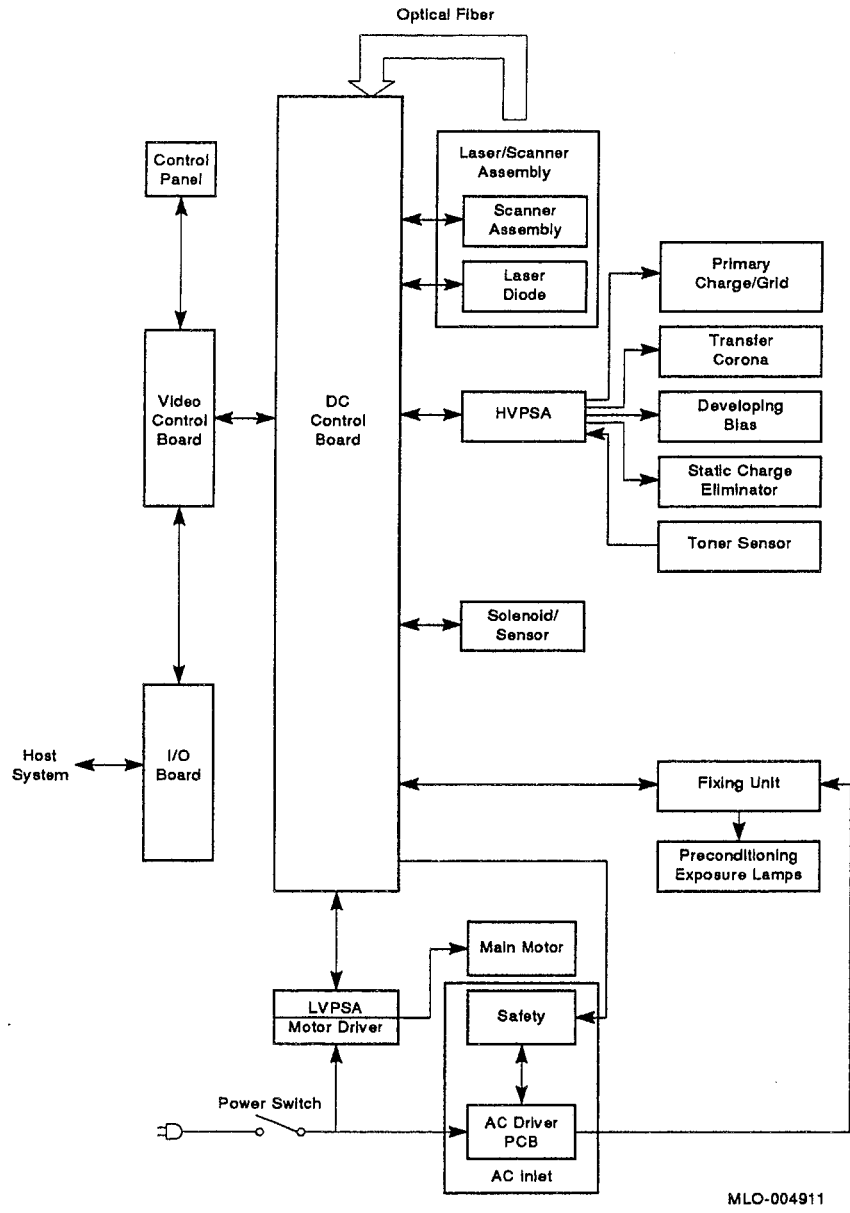

MLO-004911

1.4.1 I/O Board

The I/O board can connect to a host system by a serial RS232C interface or by a parallel 8-bit Centronics interface. Data passes directly through the I/O board. See Section A.2 for pin-out and connector information.

NOTE: *The switchpack mounted on some I/O boards is not used in the field. The correct operational setting for both switches is open.*

1.4.2 Video Control Board

The video control board receives commands and image data from the host system through the I/O board. The image data is compiled into a dot pattern and stored in the page memory to be output to the laser scanner assembly through the dc control board.

Figure 1-8 shows the major blocks of the video control board.

Figure 1-8: Video Control Board

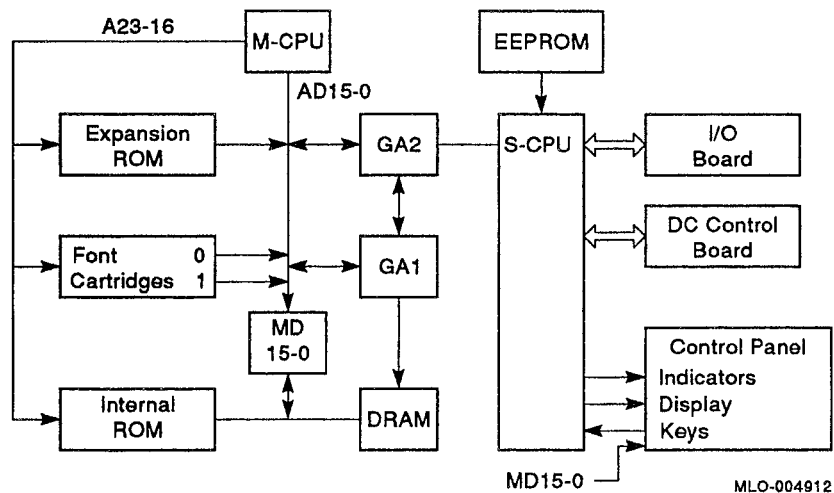

- The main central processing unit (M-CPU) is a 32-bit microprocessor that controls all activity on the video control board.
- The subcentral processing unit (S-CPU) is a 16-bit microprocessor that operates as a slave to the M-CPU.

The S-CPU does the following:

- Controls the host system and video control board communication, through the logic elements on the I/O board.
- Reads and operates the keys, display, and all indicators on the control panel except the jam indicators. (The jam indicators are operated by the dc control board.)
- Controls read/write access to the electrically erasable programmable read-only memory (EEPROM). The EEPROM is referred to as NVRAM by the control panel display (nonvolatile random-access memory).
- Operates the dc control board through 14 logic level signals shown in Figure 1-9 and Figure 1-10.
- Generates refresh clock pulses that maintain data bits stored in dynamic random-access memory (DRAM).
- Controls all communication between the M-CPU and elements on the video control board.
- Gate array 1 (GA1) controls the direct memory access (DMA) process to the DRAM. The DRAM is accessed by the dc control board and by devices on the video control boards.
- Gate array 2 (GA2) controls the transfer timing of the dot pattern data to the dc control board.
- The DRAM is divided into the following three fields (the size of which is adjustable through the control panel setup menu):
 - The page (input) buffer contains data received from the host system.
 - The page memory contains the image data bitmap or dot pattern data.
 - The font cache memory contains processed fonts.
- The read-only memory (ROM) holds the image data that makes up the internal fonts and stores the firmware operating programs of the video control board.

1.4.3 DC Control Board Signals

The dc control board operates and distributes power to all the electronic and electromechanical elements in the printer.

Figure 1-9 shows the input signals to the dc control board from the print engine, duplex unit, and video control board.

Figure 1-9: 2100 DC Control Board Input Signals

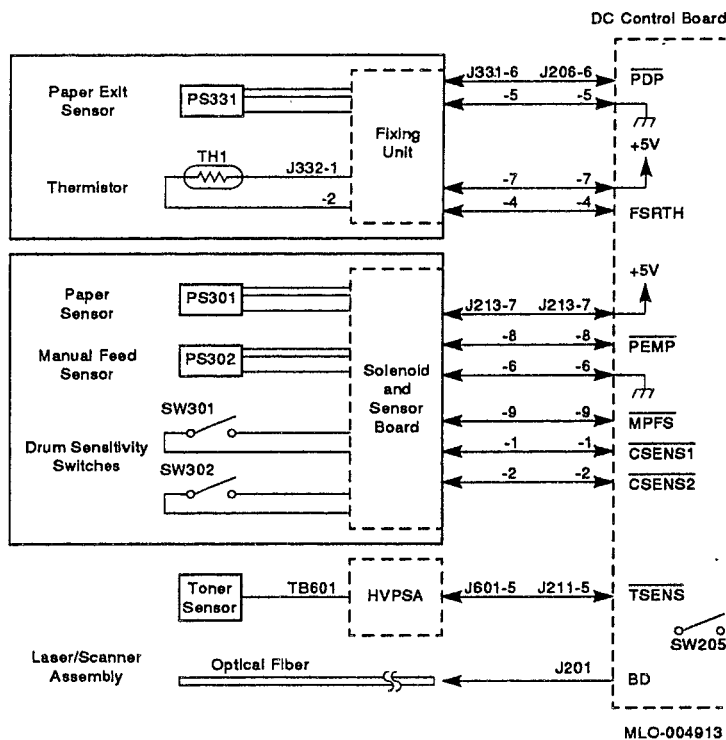

Figure 1-10 and Figure 1-11 show all the output signals from the dc control board.

Figure 1-10: 2100 DC Control Board Output Signals (Part 1)

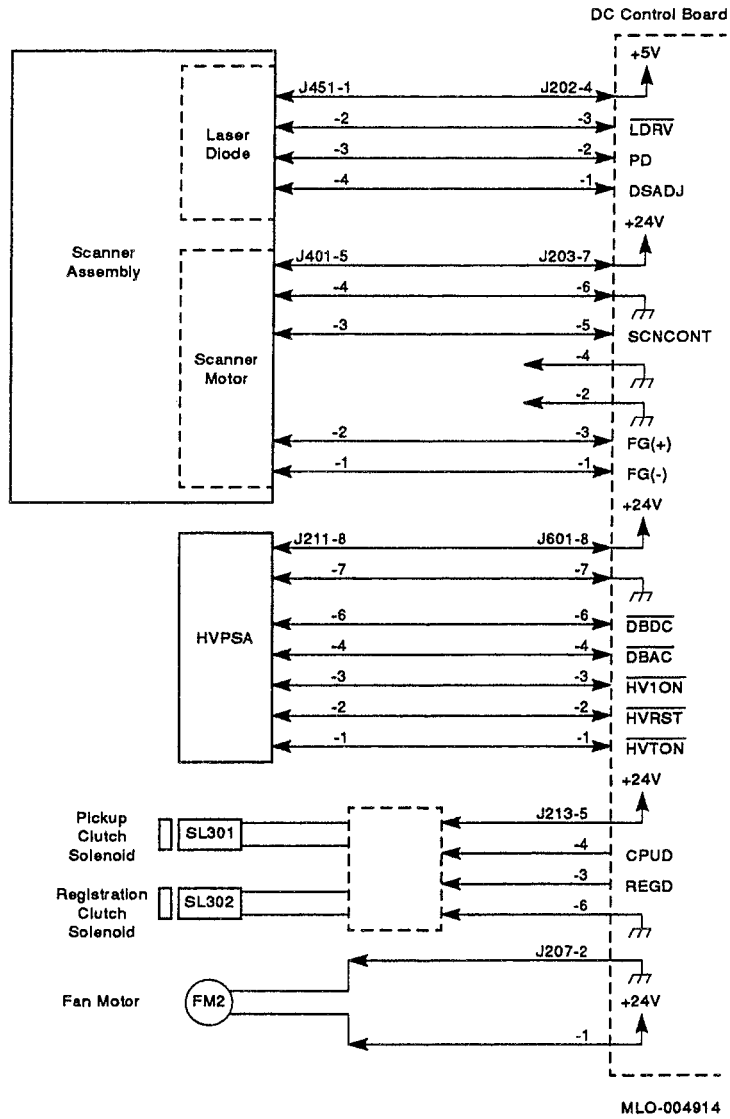
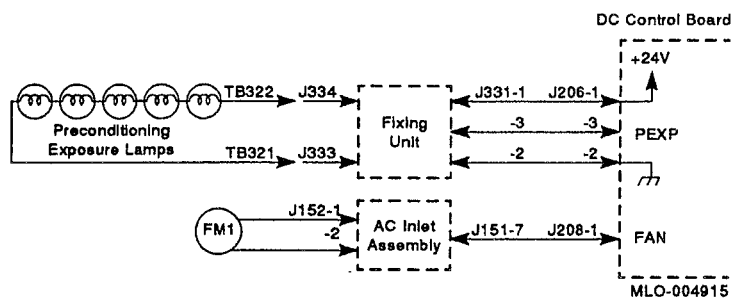

Figure 1-11: 2100 DC Control Board Output Signals (Part 2)



1.4.4 LVPSA, Main Motor, and Interlock Diagram

Figure 1-12 shows the major sections of the low-voltage power supply assembly (LVPSA). The LVPSA consists of dc low-voltage power supply regulators, two interlock switches, and the high current drivers for the main motor that drives the print engine.

Figure 1-12: LVPSA Block Diagram

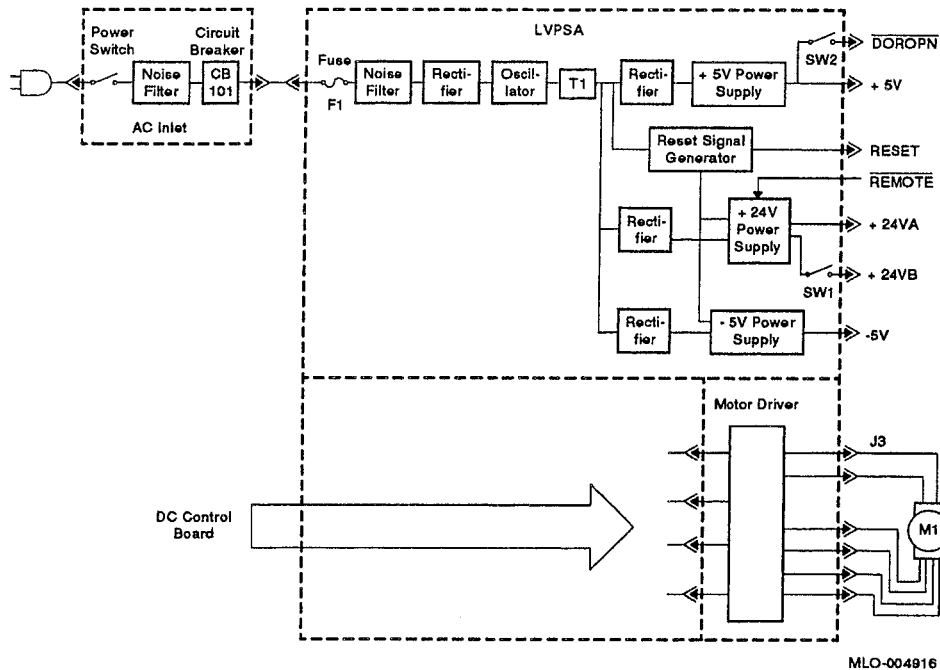

1.4.5 Fixing Heater Control Circuit

The fixing heater current is controlled by ac driver and safety circuits, whereas the fixing temperature is measured and regulated by the dc control board. The ac driver and safety circuit are parts of the ac inlet assembly field replaceable unit (FRU). Figure 1-13 is a diagram of the circuits that control the fixing unit heater.

Figure 1-13: Fixing Heater Diagram

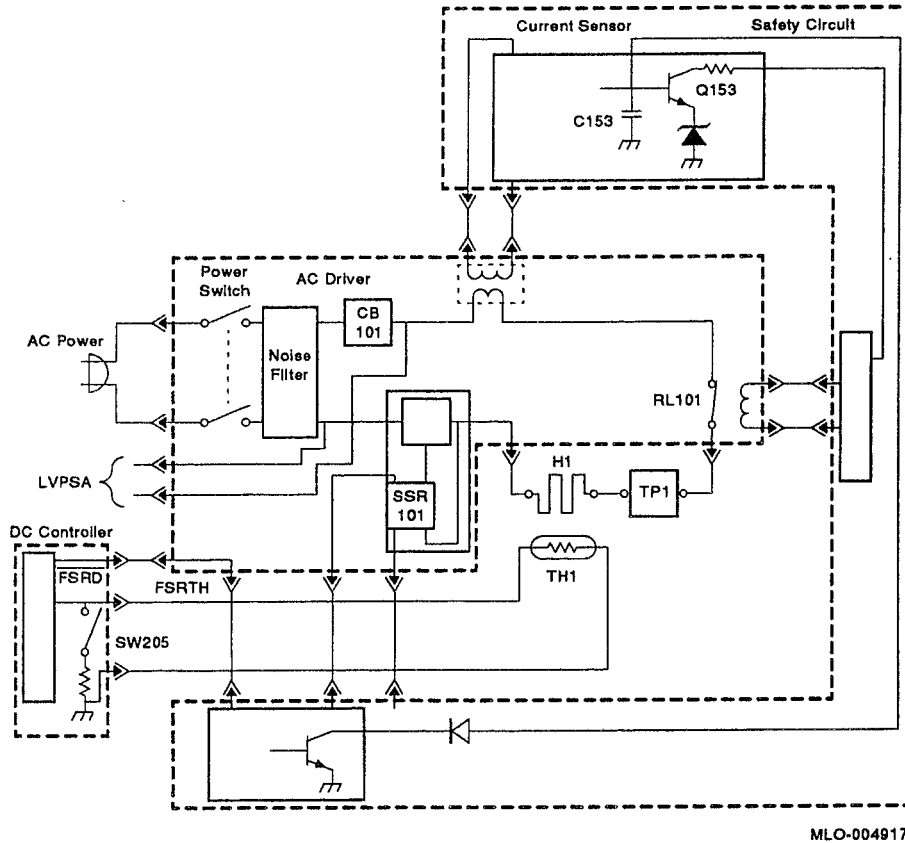

MLO-004917

The ac line power is directed through the power switch, noise filter, and CB101. From CB101 the ac line power is directed to the LVPSA and to the fixing heater circuits.

The following serial devices control the fixing heater current:

- Relay RL01 is operated by the safety circuit.
- The solid state relay (SSR) is operated by the dc control board.
- The thermoprotection (TP1) switch is actuated directly by the heat coming off the fixing heat roller.

Safety Circuit

The safety circuit consists of a fixing heater current monitor and a timer circuit that controls relay RL01. The current transformer monitors the current drawn by the fixing heater and charges C153. If the fixing current get too high, C153 turns on Q153, which opens the RL01 contact. The *FSRD* signal also causes C153 to fully charge when a fixing unit error (50 SERVICE) has occurred.

Once RL01 has opened, it is kept open until C153 discharges. C153 stays fully charged until the ac power is turned off, then C153 slowly discharges. About 10 minutes are required for the discharge. If you turn the power back on before C153 discharges, C153 recharges and the 50 SERVICE message is redisplayed.

SSR Circuit

The SSR switches the fixing heater current on and off to regulate the fixing unit temperature. The resistance of the thermistor (TH1) varies according to the heat of the fixing roller. The dc control board measures the resistance of TH1 and turns SSR on to raise the temperature or off to allow the fixing unit to cool.

- When the printer is at standby, the fixing temperature is maintained at 165°C (329°F).
- When the printer starts to print, the fixing temperature is quickly raised to 180°C (356°F).

The dc control board displays the 50 SERVICE error message if the fixing unit roller temperature:

- Fails to exceed 30°C (86°F) within 18 seconds after power on
- Fails to exceed 165°C (329°F) within 90 seconds after power on
- Exceeds 230°C (446°F)
- Drops below 140°C (284°F) after the Ready indicator goes on

SW205

Switch SW205 is mechanically actuated by the bottom cover. When the bottom cover is on, the switch is open and TH1 operates normally. When the cover is off, the SW205 is closed and a dummy load is connected across TH1, thus simulating a correctly warmed fixing temperature. The dc control board never turns on the SSR, and the fixing unit stays cool. SW205 is not used in the field. The TP1 thermoprotection switch is a passive temperature-operated switch that is mounted next to the fixing

heater roller. TP1 opens if the fixing unit temperature climbs to 210°C ±10% (410°F).

1.4.6 HVPSA Circuits

The HVPSA assembly consists of the high-voltage power supplies and an attached connector block that are crucial to the production of the image. The assembly is replaced as an FRU. You should not attempt to adjust the HVPSA in the field.

When the top cover is closed, the EP-S cartridge contacts make connection with the coil and flat spring contacts of the connector block. The coil spring contacts are used for high-voltage connection. The flat spring contacts connect the toner sensor signal and high-voltage common return bus (HVGND) to the EP-S cartridge.

The coil spring connectors are chrome plated and require no maintenance. Use a soft brush to clean away dust or paper chips, but avoid using commercially available liquid or aerosol contact cleaners. Replace the HVPSA if the connector block plastic is broken or damaged, or if the contacts appear burnt, pitted, or bent. Do not attempt to scrape clean, bend back, or repair damaged contacts.

Figure 1-14 presents a side profile of the connector block and identifies each connector.

Figure 1-14: HVPSA Connector Block

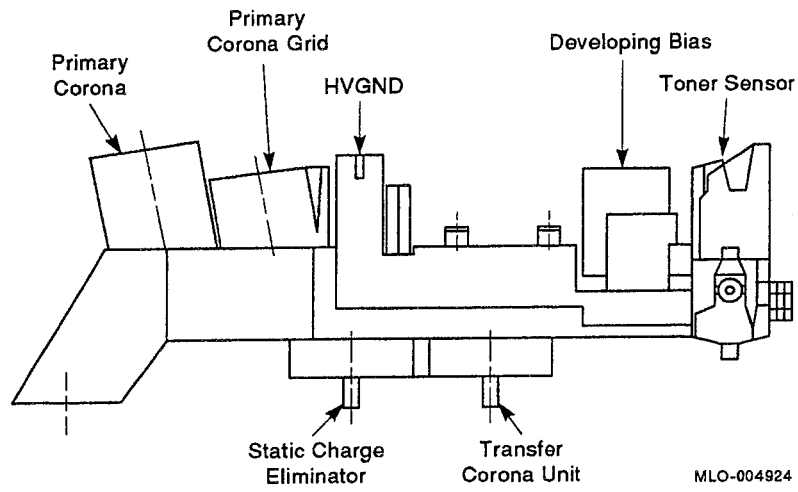
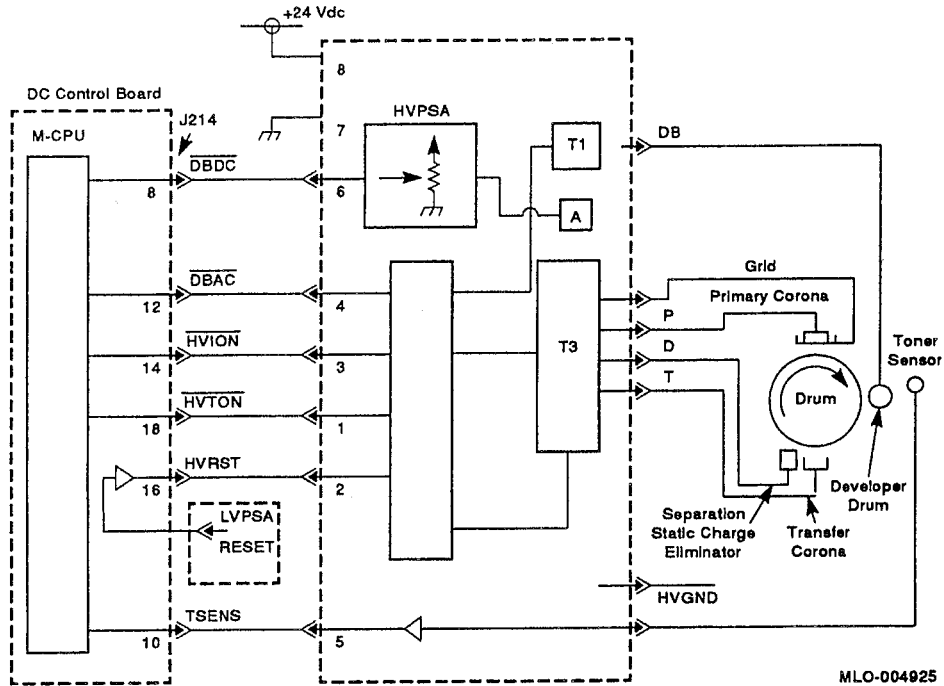

Figure 1-15 gives signal names, connector numbers, and shows the circuitry that drives and loads the HVPSA.

Figure 1-15: HVPSA Image Circuits



DEClaser 2100 Control Panel Operation

2.1 Control Panel Keys and Indicators

This chapter describes the operation of the control panel on the DEClaser 2100 printer.

- Table 2-1 describes the indicators.
- Table 2-2 describes the offline ready keys.
- Table 2-3 describes the menu scrolling keys.
- Table 2-4 describes the setup menu.

Control Panel Modes

The DEClaser 2100 printer runs in either the online ready or offline ready mode of operation. The On Line indicator shows the online or offline status. The text 00 READY is displayed when the printer is ready to receive commands.

The online ready mode means that the printer is ready to receive commands or a text or font file from the host system. Most of the keypad keys are disabled when the printer is on line. If you press a disabled key, the control panel beeper sounds and the key is ignored.

The offline ready mode means that the printer is ready to receive commands from the control panel. You can activate any of the keypad functions shown in Figure 2-3 when the printer is in the offline ready mode.

NOTE: *The text 00 READY can be replaced or modified by a firmware enhancement (upgrade) cartridge, for example the PostScript option cartridge that installs in font cartridge slot A.*

2.1.1 Control Panel Indicators

Figure 2-1 shows the location of all indicators; Table 2-1 describes how they work.

Figure 2-1: Control Panel Indicators

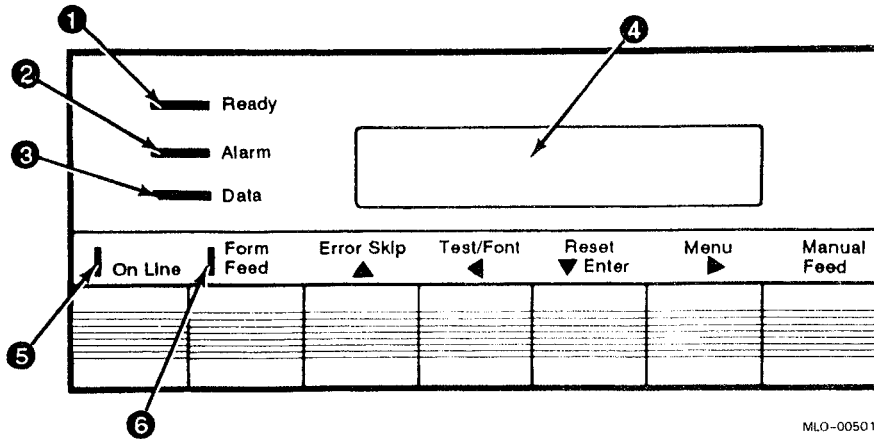

MLO-005010

Table 2-1: Control Panel Indicators

Indicator	Function
① Ready ¹	The indicator is either on, off, or flashing. If on, the printer is ready. If flashing, the printer is performing a function (for example, the printer is warming up) and you must wait.
② Alarm ²	Indicates a status condition that is disabling the printer. Alarm conditions require the attention of an operator or service person. The display panel tells you the nature of the alarm indication.
③ Data ¹	Indicates the condition of the buffer memory. The indicator is either on, off, or flashing. If on, there is print data in the buffer. If off, the buffer is empty. If flashing, the buffer is receiving print data from the host system.

NOTE: *Buffer memory is separated into two buffers. The page buffer memory contains page data. The receive buffer memory contains temporary data.*

¹ Color when lit is green.

² Color when lit is orange.

Table 2–1 (Cont.): Control Panel Indicators

Indicator	Function
④ Message display ¹	<p>A one-line, 16-character liquid crystal display. During online or offline operation, a two-digit status code and a summary status message are displayed. When the printer is in the setup menu, a horizontal setup menu is displayed. See Section 2.2 and Table 2–4 for information on the setup menus.</p> <p>With the exception of 00, all two-digit status numbers flash to attract attention of the operator. To interpret the display messages, refer to one of the following tables:</p> <ul style="list-style-type: none">• Table 3–1, Operational Status Messages• Table 3–2, Operator Call Messages• Table 3–3, Functional Messages• Table 3–4, Service Messages
⑤ On Line ¹	<p>The indicator is either on, off, or flashing. If on, the printer is on line. If off, the printer is off line. It flashes when the printer is switching to the offline state.</p>
⑥ Form Feed ¹	<p>The indicator is either on, off, or flashing and works in conjunction with <u>Form Feed</u>. If on, the printer is printing the remaining buffered data. If off, there is no form feed activity. If flashing, the print command is canceled.</p>

¹ Color when lit is green.

2.1.2 Control Panel Keys

Figure 2–2 uses numbered callouts to identify the location of the control panel keys. Refer to Table 2–2 for a description of the function of each numbered key.

Figure 2-2: 2100 Keypad Keys

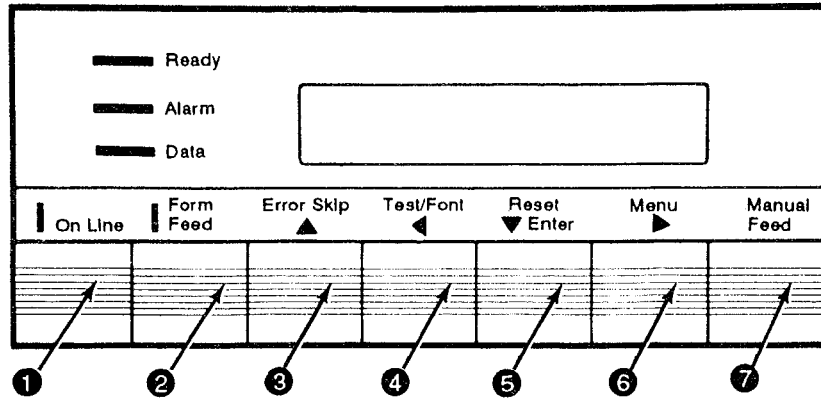



MLO-005011

Table 2-2: Offline Ready Keys

❶	On Line	Toggles the printer between the online and offline states. In online ready mode, the printer can receive, buffer, and print data from the host system. In the offline ready mode, the printer can generate and print internal test pattern data. If the printer is set off line while receiving data or printing, the reception is abruptly terminated but the full page is printed.
❷	Form Feed	Activates the form feed process to print remaining buffer data and eject paper from the printer. The key only works when the Data and Ready indicators are on, and when the printer is off line.
❸	Error Skip ▲ ¹	Returns the printer to the offline ready mode from an error or alarm condition, and clears the Alarm indicator and the display message.
❹	Test/Font ◀ ¹	Pressing this key causes the following actions: <ul style="list-style-type: none"> • Press once, prints one Test Print A. • Press twice, prints one Font List A. • Press and hold, continuously print Test Print B. Press again to stop. • Pressing the key multiple times stops the test and displays the TEST STOP message.

¹See Table 2-3 for description of this menu scrolling key.

Table 2–2 (Cont.): Offline Ready Keys

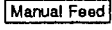
5		Pressing  clears the data from the DRAM, selects the values stored in RAM as current settings, and if depressed for longer than 10 seconds, activates the Control Representation Mode (see Section 2.4).
6		Causes the printer to enter the setup menu and redefines the function of the dual-labeled keys. Section 2.2 gives more information about the setup menus.
7		Toggles the printer between manual and automatic paper feeding modes of operation. When set to manual, the display prompts you to load a sheet of paper into the manual feeder. When the manual feed sensor detects the paper, the dc control board activates the paper feed clutch and feeds the paper into the registration rollers.

¹See Table 2–3 for description of this menu scrolling key.

2.2 Setup Menu Operation

As shown in Figure 2–3, when you press  you enter the first of a three-level setup menu. Table 2–4 lists all of the setup menus, features, and values.

Figure 2-3: 2100 Keypad Operation



MLO-004918

2.2.1 Setup Menu Format

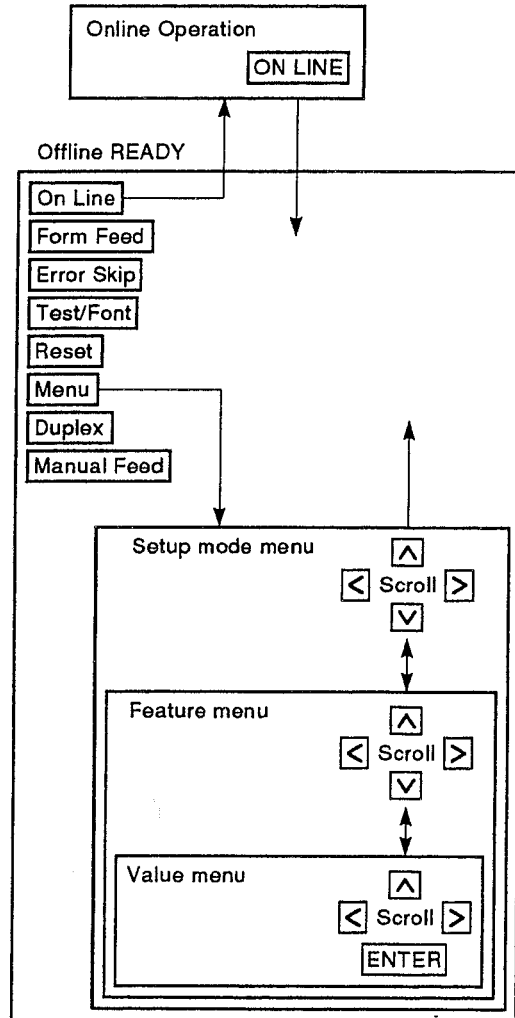
The horizontal format of the text in the setup menu is unique. Figure 2-4 shows how the text appears in the window when the printer is in a setup, feature, or value menu. You press the function keys to move through the selection. The selected text is left-justified and indicated by an underline cursor. Ignore any text, separated by a space, on the right of the display.

Figure 2-4: Setup Menu Display Text

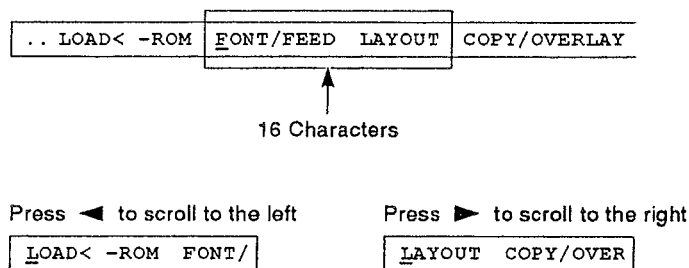

MLO-004919

2.2.2 Moving, Selecting, and Saving Values

Table 2-3 shows the action of the function keys when you scroll through the setup, feature, and value menus.

Table 2-3: Menu Scrolling Keys

Key	Function
▼	Shifts down through the feature and value menus. Down-shifting stops after the value menu.
▲	Shifts up through the value, feature, and setup menus. Up-shifting stops at the offline ready level.
◂ and ▸	Use for scrolling through the selection of the setup, feature, and value menus. The circular scrolling action returns to the starting selection after stepping through each available selection. When a scrolling key is pressed, the text and cursor move. The selected text is left-justified and is indicated by an underline cursor.
Enter	Enters the selected value into the operational memory space and marks the value with an equal (=) sign.

Table 2-4 describes the setup, feature and value menus.

Table 2-4: 2100 Setup, Feature, and Value Menus

Setup Level	Feature Level	Value Level	Comment
FONT/FEED	feeder	Cass. =Manual	<p>Operates exactly the same as pressing [Manual Feed]. It sets up the DEClaser 2100 to feed paper manually, one sheet at a time, or automatically from the installed cassette.</p> <p>When set to manual, the display prompts you to load a sheet of paper into the manual feeder. When the manual feed sensor detects the paper, the dc control board activates the paper feed clutch and feeds the paper into the registration rollers.</p>
LAYOUT	offsetX offsetY	n.n =0.0	<p>The X and Y offset features use the same value format. The selected value causes a shift of the printed image on the page, in the selected dimension:</p> <ul style="list-style-type: none"> • The X dimension shifts the image from side to side by varying the start of the beam on the OPC drum. • The Y dimension shifts the image from leading to trailing edge by varying the timing of the registration clutch solenoid. <p>Pressing [<] or [>] increments or decrements the displayed value by ± 0.5. Each 0.5 change shifts the image by ± 15 dots or ± 0.05 in (± 1.27 mm).</p> <p>The minimum value is 0.0, which corresponds to the center of the sheet. The maximum value is ± 10, which would shift the image about 1.0 inch in the selected X or Y direction.</p>

The LOAD<- ROM factory values are in bold.

The equal (=) sign indicates the selected value. When you scroll into a value level, the selected value is displayed first.

Table 2-4 (Cont.): 2100 Setup, Feature, and Value Menus

Setup Level	Feature Level	Value Level	Comment
LAYOUT (Cont.)	autoNL	=ON OFF	Determines if the line of text is truncated or wrapped at the right-hand margin. When set to ON, the printer automatically inserts a carriage return and line feed character to wrap the text on the next line. When set to OFF, the printer truncates the line at the right-hand margin.
COPY/OVERLAY	copy	nn =00	Determines the number of copies of a page that the printer prints. For example, if set to =05, five copies of each page are printed before the the printer accepts the next page from the host system. The number counts from 01-99 in increments of 1.0.
COMMAND	message	English =Finnish French German Italian Japan Norway Port. Spanish Swedish Danish Dutch	The language text appears on the display when the printer is in the online ready mode. The setup menus always are displayed in English.
INITIAL	macro	yyy 000	Counts up or down from 000-099 in increments of 1.0. The macro feature is used to set the printer environment to match that of the host system. The macro number is a combination of the device identification and character set (Cset) numbers. The sum of the two numbers is entered as the macro number. See Appendix A for a list of identification and Cset numbers.

The LOAD<- ROM factory values are in bold.

The equal (=) sign indicates the selected value. When you scroll into a value level, the selected value is displayed first.

Table 2-4 (Cont.): 2100 Setup, Feature, and Value Menus

Setup Level	Feature Level	Value Level	Comment
INITIAL (Cont.)	paint	=Partial Full Dual	<p>The amount of available memory determines which values are displayed.</p> <ul style="list-style-type: none"> • If the minimum amount of memory is installed (1024 KB), you can only select the Partial value; Full and Dual are not displayed. • If the 1-MB optional memory is installed, you can select Partial or Full; Dual is not displayed. • If either the 2-MB or 3-MB optional memory or more is installed, you can select Partial, Full, or Dual. <p>The paint selection allocates the size of the font cache and page areas of available memory. As more and more processed (bitmapped) fonts are cached, more of the available memory is utilized; this leaves less room for bitmapped print data and slows down the printer. More time is required to bitmap a smaller area, which eventually causes the 21 COMPLEX DATA message to be displayed. See Table 3-3 for additional information.</p> <ul style="list-style-type: none"> • When you select Partial, a portion of a page is bitmapped, then printed. • When you select Full, one full page is bitmapped, then printed. • When you select Dual, two complete single-page bitmaps are reserved in memory. This enables the printer to simultaneously print page one and bitmap page two.

The LOAD<- ROM factory values are in bold.

The equal (=) sign indicates the selected value. When you scroll into a value level, the selected value is displayed first.

Table 2-4 (Cont.): 2100 Setup, Feature, and Value Menus

Setup Level	Feature Level	Value Level	Comment
INITIAL (Cont.)	paper	Letter A4	<p>The selected value of the paper feature establishes the default size of the image and the sheet of paper that are requested for manual feeding.</p> <p>The printer adjusts the size of the image to fit on the requested size sheet and displays the paper feed message to prompt an operator to load a specific size sheet of paper. See the PF FEED messages listed in Table 3-2 for details of the paper feed message.</p> <p>The following actions establish the size of the printed image and the requested sheet size:</p> <ol style="list-style-type: none">1. Escape sequences transmitted from the attached host system select any of the standard sizes or can set a variable size.2. If no escape sequences are received (for example, when you print the test patterns in offline ready mode), the cassette size key selects the image and paper size to the size of the installed and selected cassette.3. If no escape sequences are received and no cassette is installed, the selected paper value determines the image size and the paper feed size.

The LOAD<- ROM factory values are in bold.

The equal (=) sign indicates the selected value. When you scroll into a value level, the selected value is displayed first.

Table 2-4 (Cont.): 2100 Setup, Feature, and Value Menus

Setup Level	Feature Level	Value Level	Comment
INTERFACE	i/f	=RS232C CENTRO	<p>If you select CENTRO, the parallel 8-bit Centronics port is activated. There are no features or values associated with the CENTRO selection. All speeds and signals are fixed.</p> <p>If you select RS232C, the serial RS232C compatible port is activated.</p> <p>The following parameters are always printed on the Test Print A sheet, but are displayed only when RS232C is selected.</p> <p style="padding-left: 40px;"> baud rsmode dtr xon/xoff etx/ack </p>
	baud ¹	19200 9600 4800 =2400 1200 600 300	Establishes the baud rate of the serial port. The baud rate of the printer must match the baud rate of the host system.
	rsmode ¹	8S 8SS =7OS 7ES 7OSS 7ESS 8OS 8ES	<p>The values define the characteristics of the RS232C serial data byte and must match the host system. The following example shows the format:</p> <p style="padding-left: 40px;">8OS</p> <p>where: 8 is the number of data bits. O means odd parity, E means even parity, no O or E means no parity checking. S means one stop bit is used.</p>

¹This value appears only if you select RS232C.

The LOAD<- ROM factory values are in bold.

The equal (=) sign indicates the selected value. When you scroll into a value level, the selected value is displayed first.

Table 2-4 (Cont.): 2100 Setup, Feature, and Value Menus

Setup Level	Feature Level	Value Level	Comment
INTERFACE (Cont.)	dtr ¹	READY-H =Fix-H	Sets the state of the serial connector DTR signal to be fixed or conditional to the online ready mode.
	xon/xoff ¹	=ON OFF	If you select ON, XON/XOFF flow control is enabled.
	etx/ack ¹	=ON OFF	If you select ON, ETX/ACK flow control is enabled.
SAVE->RAM	ok	-	Writes the selected value of COPY/OVERLAY and autoNL into RAM.
SAVE->NVRAM	ok	-	Writes all the selected values into NVRAM. The contents of NVRAM are retained through a power-down cycle.
LOAD<-ROM	ok	-	Loads all factory values from ROM to selected values.

¹This value appears only if you select RS232C.

The LOAD<- ROM factory values are in bold.

The equal (=) sign indicates the selected value. When you scroll into a value level, the selected value is displayed first.

2.3 Test Patterns

Four internal patterns can be printed when the printer is in the offline ready mode.

Pressing **Test/Font** prints the Test Print A, Test Print B, and Font Test patterns.

Pressing the TEST PRINT button prints the engine test pattern.

2.3.1 Test Print A

Press **Test/Font** briefly to print one copy of Test Print A. Figure 2-5 is a copy of Test Print A. The section labeled TEST PRINT is a status configuration listing. The section labeled Current Settings shows the selected value of every setup feature. See Table 2-4 for more information.

The numbered callouts relate the following descriptions to Figure 2-5.

- | | | |
|----------|------------------|---|
| 1 | Version | The version line lists the current revision level of the printer firmware. |
| 2 | Total Ram | Lists the amount of random-access memory (RAM) available in the printer. From the example shown in Figure 2-5 you can determine that there are 1024 Kbytes of RAM. This is the minimum amount of memory and represents the internal stock memory. This number increases by 1-, 2-, or 3-MB increments when you add a memory expansion option. |
| 3 | Font Card | Shows the number of installed font cartridges. |
| 4 | Page Count | The page count number is incremented by one each time the printer prints a page. |
| 5 | Free Ram | Indicates the amount of unused or available dynamic RAM (DRAM) space. |
| 6 | Current Settings | <p>The Current Settings block text shows you the selected value for each feature in every setup menu.</p> <p>The area of memory that the values can be stored in are also shown. For example, (RAM + NVRAM) means the current setting can be stored in RAM or NVRAM.</p> |

NOTE: *The RAM text in some memory blocks is misleading. The only values you can save to RAM are **7** copy and autoNL.*

Figure 2-5: Test Print A

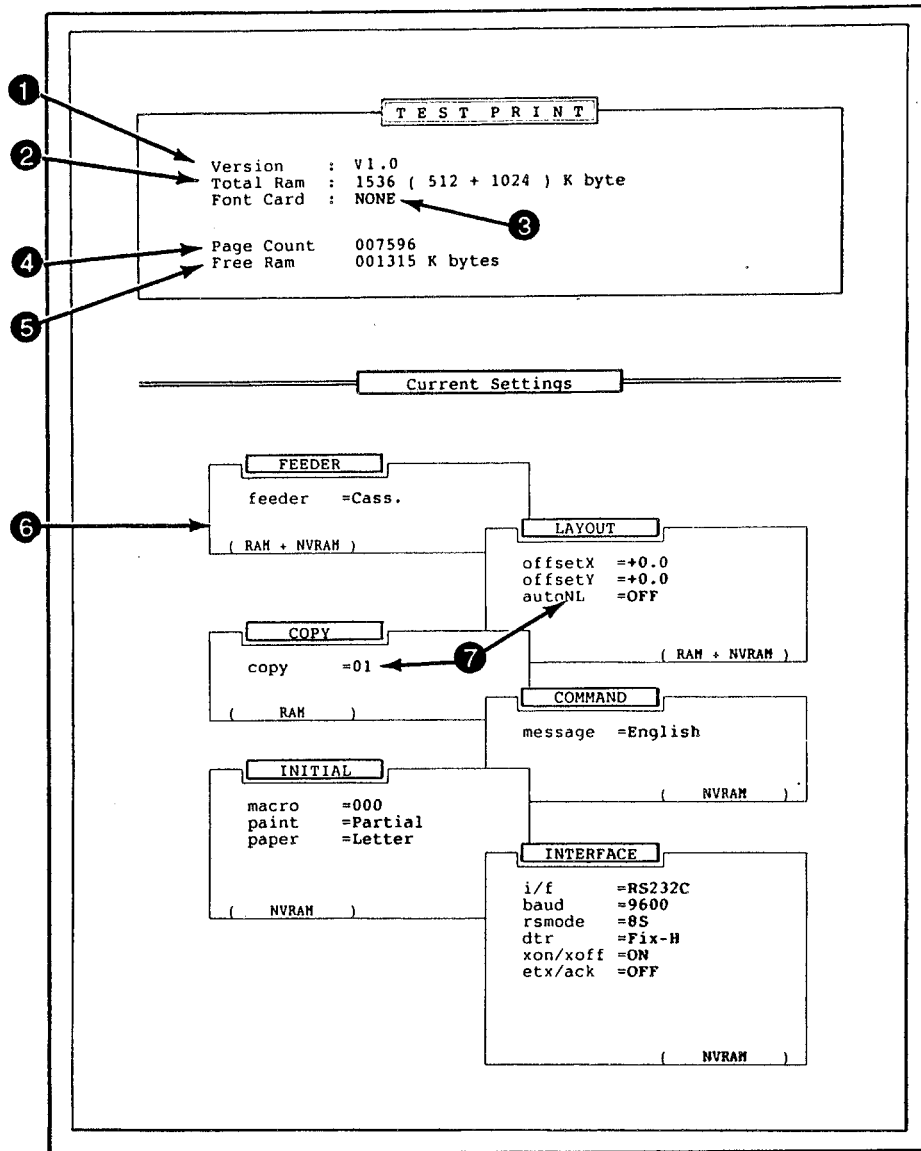

MLO-005019

2.3.2 Font List

The Font List shown in Figure 2-6 is a sample listing of all character sets available to the printer. The list includes the following:

- Internal fonts that are installed in the firmware of the printer
- Cartridge fonts
- Downline loaded fonts from a host system

Fonts are selected by escape sequences sent from the host computer. You cannot select a font from the control panel. For information about selecting fonts, refer to the *Digital ANSI-Compliant Printing Protocol Level 3 Programming Reference Manual* and the *Digital ANSI-Compliant Printing Protocol Level 3 Programming Supplement*.

To print the Font List press **Test/Font** twice. The text 06 FONT LIST A is displayed while the Font List is printing. The complete Font List is usually several pages long.

2.3.3 Test Print B

The Test Print B pattern shown in Figure 2–7 consists of an incrementing alphanumeric test pattern. The start of each line is offset by one character, and a full page of the pattern gives a spiraling effect. The Test Print B pattern is a useful troubleshooting tool for the following reasons:

- The pattern of sequentially changing characters is printed across the entire page and is readable. You can easily see any missing characters, changes in image density, and most image defects.
- You can target specific areas of the paper path by selecting faceup or facedown stacking.
- The Test Print B pattern runs continuously, which exercises the printer and enables you to thoroughly test the printer in off-line operation.
- The continuous operation can be used as a confidence test to assure any personnel working on high-level printer problems that the printer is operating correctly.

To print Test Print B, press and hold **TestFont** for about five seconds until the 01 TEST PRINT B message is displayed. The printer then continuously prints the test pattern until you press **TestFont** or **On Line** or until the paper supply runs out.

Figure 2–8: Pressing the Test Button

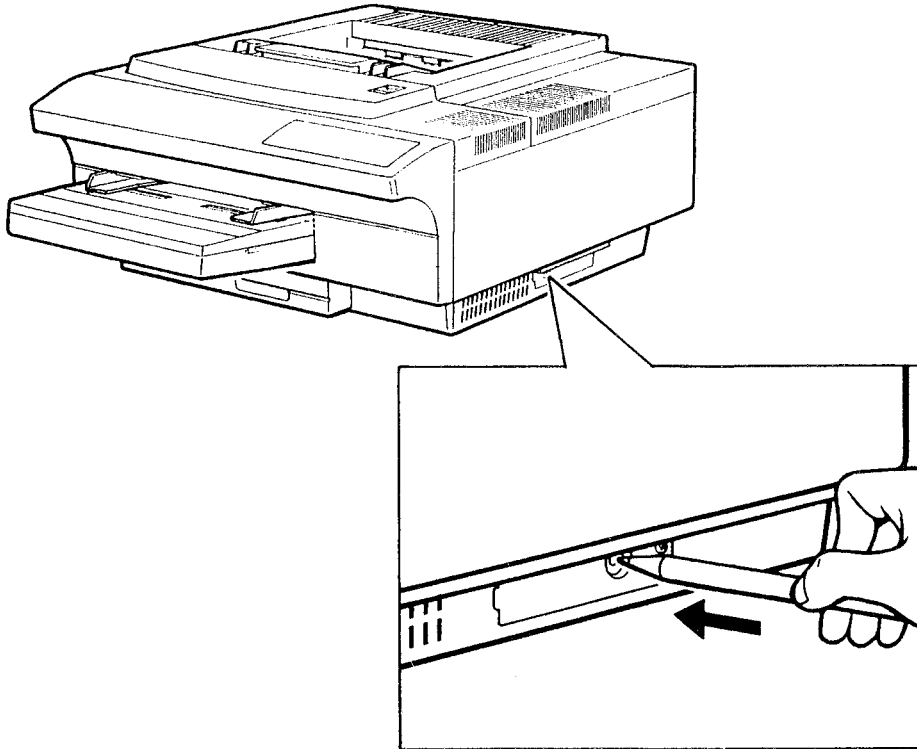

MLO-005023

Figure 2–9 is an example of the Engine Test Print. The control panel test patterns are generally more useful for troubleshooting. The Engine Test Print is commonly used for the following purposes:

- To verify the condition of the print engine.
- To check toner dispersion and line weight.
- If the control panel is non-operational, the Engine Test Print is a good indicator of the condition of the print engine.

The white area of the Engine Test Print should be free of toner or smudges, and the lines must print cleanly across the entire page with no faded areas. If the print quality is poor, refer to Section 3.5.

Figure 2-9: Engine Test Print

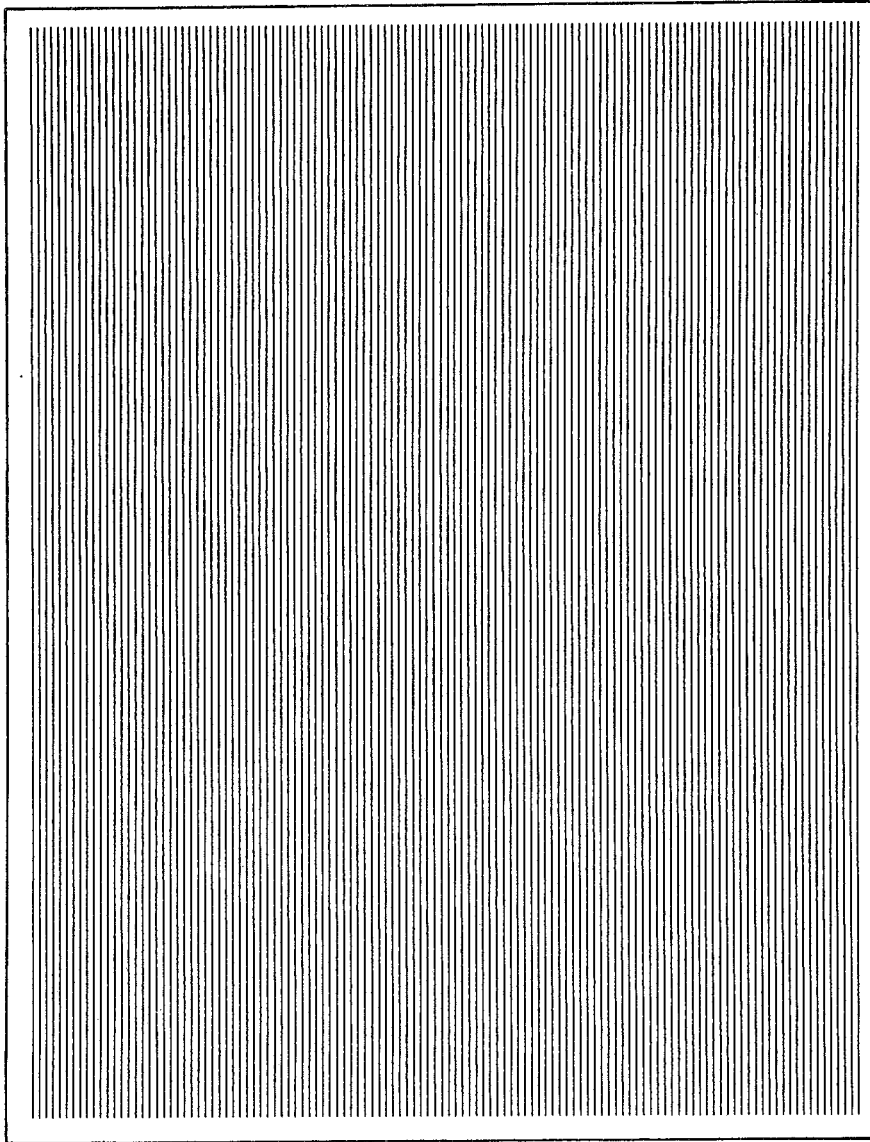

MLO-004525

2.4 Control Representation (Character Dump) Mode

The Control Representation (Character Dump) Mode is used to print out raw (unprocessed) data or commands sent from the host computer. When the mode is activated, the printer prints all the normally invisible control characters, such as carriage returns and line feeds.

For additional information about the Control Representation Mode, consult the *Digital ANSI-Compliant Printing Protocol Level 3 Programming Reference Manual*.

Use the following procedure to activate the Character Dump Mode.

1. If the printer is on line, press **On Line** to place the printer off line.
2. Press and hold **Reset** for about 10–20 seconds, then release.
3. While you are holding the key, the text 03 RESET is displayed.
4. Shortly after you release the key, the text 00 ready DUMP is displayed and the printer is in the Character Dump Mode.
5. Press **On Line** to place the printer on line.

The printer is now in the Character Dump and online ready modes and will accept data or commands from the host system.

To exit the Character Dump Mode, press **On Line** to set the printer off line, then press **Reset**.

Chapter 3

DEClaser 2100 Troubleshooting

This chapter describes the DEClaser 2100 troubleshooting fault isolation procedure (FIP). The FIP is a multipage step-by-step procedure that you use to verify and isolate malfunctions and to arrive at the correct repair procedure. The **FIP NOTES** tell you where you are in the overall FIP.

The FIP consists of the following major sections. Use the black page tabs to speedily locate the starting page of each major section.

1. Sections 3.1 and 3.2 are for troubleshooting the vague symptoms caused by a malfunctioning ac line power, dc power supply, or control panel.
2. Section 3.3 is for troubleshooting control panel alarms and display text, for example, interlocks, toner low, paper outs.
3. Section 3.4 is used to troubleshoot feed faults and paper jams.
4. Section 3.5 is used to troubleshoot image defects. Before starting this section the printer must be able to feed and stack paper.

After you repair the DEClaser 2100 printer, perform the TCC procedure in Appendix C. If the page count on Test Print A shows that 100,000 pages have been printed, perform the 100K preventive maintenance procedure.

Fill out the DEClaser 2100 maintenance log before leaving the customer's site.

3.1 Getting Started

Figure 3-1 is the start of the FIP. The FIP assumes that you have just arrived at the customer's site.

FIP NOTES: *After completing the start FIP, you will be pointed to a more specific FIP.*

Figure 3-1: Start FIP

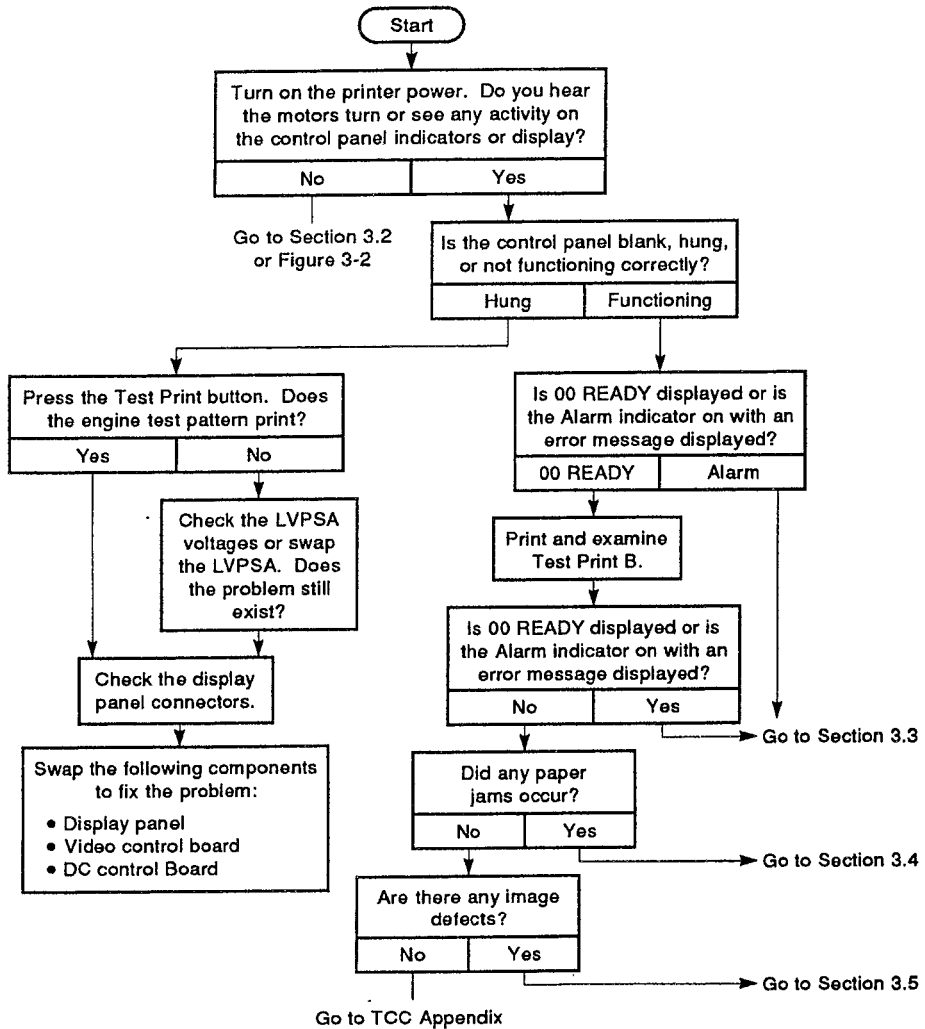

MLO-004920

3.2 Troubleshooting Power-Up Faults

You see and hear the following when you power up the DEClaser 2100 printer, assuming that both cassettes and an EP-S cartridge are installed and no error condition is detected.

1. All control panel indicators come on.
2. Solid blocks appear momentarily on the control panel display.
If optional memory is installed, an active display pattern occurs.
3. The scanner and main motors start up with a whirring sound. If any paper is left in the fixing unit, it moves into the fixing unit exit sensor to produce a 13 PAPER JAM error message, and the fixing heater does not start.
4. The text 02 WARMING UP is displayed and the Ready indicator flashes. It takes less than two minutes to achieve the 160°C (320°F) fixing unit standby temperature.
5. The text 00 READY is displayed and the Ready indicator comes on steadily.

FIP NOTES: Figure 3-2 is a continuation of Figure 3-1. Turn to the start FIP for general FIP information.

Figure 3-2: Power-Up Fault

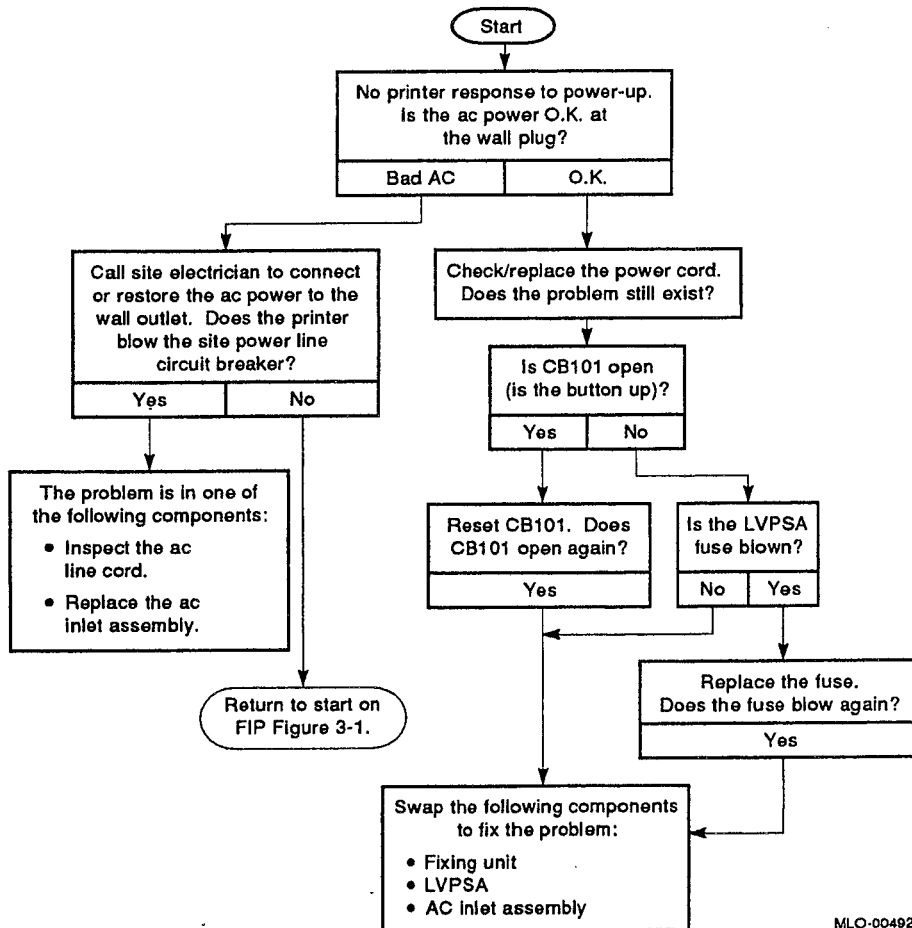

MLO-004921

3.3 Troubleshooting Control Panel Faults

The following list points to the tables that interpret the control panel display text and give information about troubleshooting. A fault condition exists if messages are displayed frequently or continuously.

- Operational status messages, Table 3-1
- Operator call messages, Table 3-2
- Functional messages, Table 3-3
- Service messages, Table 3-4

3.3.1 Status Messages and Faults

Table 3-1 lists the messages that are displayed on the control panel during normal operation of the DEClaser 2100 printer. See Section 2.1 for information about the operation and functioning of the control panel keys and indicators.

Table 3-1: Operational Status Messages

Number Message	Description and Action
00 READY	The printer is ready to print. If the On Line indicator is on, print files can be sent from the host. If the On Line indicator is off, the printer is in the offline ready mode. In the normal mode you can print test sheets, enter the setup menus, or perform any offline task.
01 TEST PRINT B	The printer is generating and printing Test Print B. See Section 2.3.3 for more information about Test Print B.
02 WARMING UP	The printer is waiting for the fixing unit to reach operating temperature. If the fixing unit fails to reach the correct operating temperature, the 50 SERVICE message is displayed.
03 RESET	This message is displayed for about four seconds to confirm that the reset function is completed. Pressing [Reset] initiates the reset function.
04 TEST STOP	This message is displayed to show that the generation and printing of a test pattern is stopping. The message is displayed while the remaining paper is printed and ejected.
05 TEST PRINT A	This message is displayed during the generation and printing of Test Print A.
06 FONT LIST	This message is displayed during the generation and printing of the Font List.
06-10	Not used.

3.3.2 Operator Call Messages and Faults

When an operator call condition occurs, the printer goes off line and an operator call message is displayed. The message disappears automatically as soon as the condition is corrected. A fault condition exists when the message cannot be cleared or is displayed for no apparent reason.

Table 3-2 lists all operator call messages, explains the message, and provides troubleshooting information if the message faults.

Table 3-2: Operator Call Messages

Number Message	Description and Action
11 PAPER OUT	<p>The cassette is empty or no cassette is installed.</p> <p>The paper-out sensor and linkage detect an empty cassette and the cassette size-sensing switches detect a missing cassette.</p> <p>Troubleshooting Use the following procedure to fix a paper out fault:</p> <ol style="list-style-type: none">1. Inspect and swap the cassette.2. Inspect and repair the linkage of the paper-out sensor.3. Swap the solenoid and sensor board.4. Swap the dc control board.

Table 3–2 (Cont.): Operator Call Messages

Number Message	Description and Action
12 PRINTER OPEN	<p>This message is displayed when the top cover of the printer is open. When the top cover is closed, the top cover switch lever presses the interlock switches. One interlock switch interrupts the main motor drive current; the other switch signals the dc control board.</p> <p>Troubleshooting Do the following if closing the cover does not automatically clear the error:</p> <ol style="list-style-type: none">1. Inspect the top cover switch lever for any damage. Make sure you hear both switches actuate as the top cover is closed. Do not confuse the sound of the drum sensitivity switches with that of the interlock switches.2. Inspect and manually actuate the interlock switch. Fix or replace the LVPSA if you find the switches are damaged or not operable.3. Replace the LVPSA.4. Replace the dc control board.
13 PAPER JAM	<p>This message is displayed when paper is jammed in the printer paper path and causes the dc control board to inhibit printer operation.</p> <p>If the message appears at power-up, the jammed paper is actuating the exit sensor in the fixing unit.</p> <p>The jam display message clears when you open and then close the top cover, or when you press [Error Skip].</p> <p>The printer may require repair if you cannot clear the error message and display or if jams occur shortly after the printer resumes feeding.</p> <p>Troubleshooting To begin troubleshooting a jam, turn to the start FIP at Figure 3–3.</p>

Table 3-2 (Cont.): Operator Call Messages

Number Message	Description and Action
14 NO EP-CART	<p data-bbox="596 555 1264 600">This message is displayed when the top cover is closed and both drum sensitivity switches remain off.</p> <p data-bbox="596 622 1264 741">When the top cover is closed, the sensitivity tabs on the EP-S cartridge actuate one or both of the drum sensitivity switches that signal the dc control board. The dc control board responds to the signal by setting the laser beam intensity and allowing the initialization process to proceed.</p> <p data-bbox="596 763 1264 808">Troubleshooting Do the following if the error cannot be cleared or if it appears intermittently:</p> <ol data-bbox="596 831 1264 1167" style="list-style-type: none"><li data-bbox="596 831 1264 898">1. Inspect the sensitivity tabs on the EP-S cartridge. Either one or two tabs must be installed. If there are no tabs, replace the EP-S cartridge.<li data-bbox="596 920 1264 1077">2. Inspect the levers that actuate the drum sensitivity switches on the sensor and solenoid board. Press the levers with your finger, listen for the clicking of both switches, and make sure the levers move freely. Make sure the switches actuate when the top cover is closed. Replace the sensor and solenoid board if the sensitivity switches are defective.<li data-bbox="596 1099 1007 1122">3. Swap the solenoid and sensor board.<li data-bbox="596 1144 927 1167">4. Replace the dc control board.
15 ENGINE TEST	<p data-bbox="596 1211 1264 1279">This message is displayed during the generation and printing of the print engine internal test pattern, which is initiated when you press the TEST PRINT button on the dc control board.</p>

Table 3–2 (Cont.): Operator Call Messages

Number Message	Description and Action
16 TONER LOW	<p data-bbox="592 544 1259 613">This message is displayed if the toner supply in the EP-S cartridge is exhausted or if the toner is compacted into cakes and unable to flow.</p> <p data-bbox="592 636 1259 685">Troubleshooting Do the following if the message is intermittent or cannot be cleared:</p> <ol data-bbox="592 707 1259 1108" style="list-style-type: none"><li data-bbox="592 707 1259 779">1. Remove and agitate the EP-S cartridge to loosen up the toner. Replace the EP-S cartridge if the printer prints for a while, then the message is redisplayed.<li data-bbox="592 801 1259 965">2. Inspect the HVPSA and EP-S connectors for dirt, pitting, damage, or contamination. If any damage is found, replace the FRU. Do not try to scrape, bend, or repair the contacts. Remove any dust or paper chips with a dry brush. Do not use liquid, aerosol, or any other type of contact cleaner on the high-voltage connectors.<li data-bbox="592 987 895 1010">3. Swap the EP-S cartridge.<li data-bbox="592 1032 823 1055">4. Swap the HVPSA.<li data-bbox="592 1077 930 1099">5. Replace the dc control board.

Table 3-2 (Cont.): Operator Call Messages

Number Message	Description and Action
PC LOAD A4 PC LOAD LETTER PC LOAD LEGAL PC LOAD EXEC. PC LOAD PAPER <i>nn</i>	<p>A PC LOAD request signals the operator to remove the cassette, install the requested size cassette, and press Error Skip, then On Line to resume the printing operation.</p> <p>The PC LOAD PAPER <i>nn</i> message requests the operator to load the envelope cassette. The <i>nn</i> is the paper size code number that corresponds to a specific type of envelope. The <i>nn</i> number range is 80-99.</p> <p>Troubleshooting Do the following if the message is displayed when the correct size cassette is installed:</p> <ol style="list-style-type: none">1. Inspect the cassette key and if it is damaged, replace the cassette.2. Inspect, repair, or replace any binding or sticking levers that actuate the size-sensing switches. The size-sensing switches are located on the dc control board. Press the sensing levers with your finger. Feel and listen for the free movement and a distinct click action.3. Swap the dc control board.

Table 3–2 (Cont.): Operator Call Messages

Number Message	Description and Action
PF FEED A4 PF FEED LETTER PF FEED LEGAL PF FEED EXEC. PF FEED PAPER <i>nn</i>	<p>The PF FEED message requests the operator to insert a sheet of paper into the manual paper feeder.</p> <p>When the manual feed sensor is actuated, the printer delays momentarily to allow the operator to fully insert the sheet, and then it feeds and prints the sheet.</p> <p>The PF FEED PAPER <i>nn</i> message requests the operator to manually load and feed a nonstandard size paper. The <i>nn</i> number range is 80–99.</p>
	<p>Troubleshooting Perform the following procedure to test, find, and fix a manual feed fault.</p> <ol style="list-style-type: none">1. Press Manual Feed until the FEEDER = MANUAL message is displayed.2. Press Test/Font to print a test pattern. The PF LOAD message is displayed. The requested size paper to load is determined by the size of the installed cassette or by the value selected for the paper feature on the initial setup menu. See Table 2–4 for more information about the setup menu.3. Insert a sheet of paper into the manual feeder. A fault exists if the message does not change and the pickup roller does not turn.4. Do the following to fix a PF FEED fault:<ul style="list-style-type: none">• Swap the solenoid and sensor board.• Swap the dc control board.
	<p>NOTE: <i>If the top sheet of the cassette paper feeds, instead of the manual feed sheet, you are not pushing the paper far enough or fast enough into the manual feeder. If the sheet feeds but jams, go to Section 3.4.1 to fix the paper feeding or jamming problem.</i></p>
OC text (16 characters)	Operator action request message. Press Error Skip , then On Line to continue printing.

3.3.3 Functional Messages and Faults

Table 3-3 lists the status messages, explains the message, and provides troubleshooting information if the message faults.

Table 3-3: Functional Messages

Number Message	Description and Action
FE FONT REMOVAL	<p>A font cartridge was removed or inserted while the printer was powered on. To clear this error, power the printer off, then on. Always insert or remove a font cartridge while the printer is powered off.</p> <p>Swap the video control board if you cannot clear the error.</p>
FF FONT FULL	<p>There is insufficient memory space for loading of an additional font or there are too many downline loaded fonts. Memory can be cleared by a software command from the host or by pressing Reset.</p>
20 PAGE FULL	<p>The host system is overflowing the page (input) buffer memory.</p> <p>Press Error Skip, then On Line to print the overflow data on the next page.</p> <p>To avoid this error, delete unused character sets and use the full paint mode. If this error occurs frequently, the customer can install optional memory to increase available RAM.</p>
21 COMPLEX DATA	<p>The host system is loading the page buffer faster than the printer can print. Press Error Skip, then On Line to continue printing on the next page.</p> <p>Set the paint = full value from the initial setup menu.</p>
22 LINE ERROR	<p>The host is sending data when the printer is in the busy state. This causes an overflow of the receive buffer memory. Press Error Skip, then On Line to continue. The overflow data does not print.</p> <p>This error can occur when the customer powers up the printer before powering up the attached host system.</p> <p>If this error occurs frequently, check the data cable between the host and printer and make sure the printer interface settings match the settings of the host.</p> <p>If you cannot clear this error, swap the video control board.</p>

Table 3-3 (Cont.): Functional Messages

Number Message	Description and Action
23 MEMORY FULL	<p>An overflow occurred while the host was downline loading user defined character patterns to the printer.</p> <p>Press Error Skip, then On Line to continue receiving data and ignore the data that caused the error.</p> <p>If this error occurs too frequently, the customer can increase memory by installing an optional RAM expansion.</p>
24 FULL PAINT REJ	<p>Insufficient memory space to use full paint mode. The customer can increase memory space by installing an optional RAM expansion.</p> <p>Press Error Skip, then On Line to continue printing in partial paint mode.</p>
25 VECTOR REJ	<p>Vector graphics commands from the host system cannot be used because the printer is not in full paint mode. You have two possible actions:</p> <ul style="list-style-type: none">• Press Error Skip, then On Line to continue printing. Subsequent vector graphics commands are treated as text and printed.• Stop sending data from the host, select the paint = full value from the initial setup menu, then send the data from the host again. <p>NOTE: <i>Vector graphics commands cause the printer to fill in closed areas of circles, ellipses, and other shapes.</i></p>
26 MEMORY FULL	<p>The work memory used by the video control board has overflowed and the current operation cannot be done. If this happens frequently, the customer can increase the available memory by installing an optional RAM expansion board.</p> <p>Press Error Skip, then On Line to continue receiving data from the host. The offending operation is ignored.</p>
27-39	Not used.

Table 3–3 (Cont.): Functional Messages

Number Message	Description and Action
40 LINE ERROR	<p>The printer detects errors in the serial data received from the host. The printer stops printing before the offending page and displays the error message.</p> <p>Do the following:</p> <ol style="list-style-type: none">1. Press Error Skip, then On Line to continue receiving data.2. Inspect the data cable and connectors between the host and printer and make sure the printer interface settings match the settings of the host.
41 PRINT CHECK	<p>A soft error occurred that can cause a print defect. Remove and discard the top sheet from the stack. Then press Error Skip to continue printing and to reprint the discarded sheet.</p> <p>Do the following if the error occurs frequently or cannot be cleared:</p> <ol style="list-style-type: none">1. Check the connection between the scanner assembly and dc control board.2. Swap the scanner assembly.3. Swap the dc control board.
42 ERROR	Expansion interface board error.
43 ERROR	Expansion interface board error.

3.3.4 Service Messages

Table 3–4 lists service error messages, explains the message, and provides troubleshooting information if the message faults.

Table 3–4: Service Messages

Number Message	Description and Action
50 SERVICE	<p>This fixing unit fault message is caused by a malfunction of the regulation of the fixing unit temperature. If the fixing unit heater is inoperative when the power is turned on, the 02 WARMING UP message is displayed for two minutes before the 50 SERVICE message is displayed. See Section 1.4.5 for additional information about the fixing unit temperature control.</p> <p>Troubleshooting Use the following procedure to correct the fixing unit temperature problem:</p> <ol style="list-style-type: none">1. If the error occurs at power-up, the malfunction might be corrected but you may not have allowed a full 10 minutes of power-off time for the error to clear.2. Inspect or swap the fixing unit. Make sure the fixing unit connectors are undamaged and the pins align correctly with the sockets. If you find any damage, replace the fixing unit.3. Swap the ac inlet assembly.4. Swap the dc control board.
51 SERVICE	<p>The dc control board fails to detect the beam detect (BD) signal from the scanning unit.</p> <p>Inspect the actuator tab on the EP-S cartridge and the shutter lever mechanism on the scanner assembly for signs of damage. Make sure the tab actuates the shutter lever on the scanner assembly when the top cover closes.</p> <p>Swap the following components until the message clears:</p> <ol style="list-style-type: none">1. EP-S cartridge2. Scanner assembly3. DC control board

Table 3-4 (Cont.): Service Messages

Number Message	Description and Action
52 SERVICE	<p>The scanner motor is not up to speed. Check the scanner assembly electrical connectors for good connections. Swap the following components until the message clears:</p> <ol style="list-style-type: none">1. Scanner assembly2. DC control board
53-59	Not used.
60 SERVICE	<p>This is a direct memory access (DMA) error that occurs after you power up the printer.</p> <p>Swap the following components until the message clears:</p> <ol style="list-style-type: none">1. Video control board2. DC control board
61 SERVICE	<p>A checksum error was detected in the program and font ROMs.</p> <p>Swap the following components until the message clears:</p> <ol style="list-style-type: none">1. Video control board2. DC control board
62	Not used.
63 SERVICE	<p>RAM errors were detected after power-up.</p> <p>Swap the following components until the message clears:</p> <ol style="list-style-type: none">1. Video control board2. DC control board
64-67	Not used.

Table 3-4 (Cont.): Service Messages

Number Message	Description and Action
68 SERVICE	<p>NVRAM errors were detected after printer power-up.</p> <p>Swap the following components until the message clears:</p> <ol style="list-style-type: none">1. Video control board2. DC control board
69 SERVICE	<p>A timeout error occurred because no status information was returned from the expansion interface. To clear this error, you must power the printer off, then on.</p> <p>Swap the following components until the message clears:</p> <ol style="list-style-type: none">1. Video control board2. DC control board
70 SERVICE	<p>Errors were detected in the expansion board RAM.</p> <p>Swap the following components until the message clears:</p> <ol style="list-style-type: none">1. Video control board2. DC control board
71 SERVICE	<p>Errors were detected in the S-CPU during power-up.</p> <p>Swap the following components until the message clears:</p> <ol style="list-style-type: none">1. Video control board2. DC control board
72 SERVICE	<p>A communication error occurred between the S-CPU and M-CPU.</p> <p>Swap the following components until the message clears:</p> <ol style="list-style-type: none">1. Video control board2. DC control board

Table 3-4 (Cont.): Service Messages

Number Message	Description and Action
73 SERVICE	<p>An error was detected in the S-CPU during operation.</p> <p>Swap the following components until the message clears:</p> <ol style="list-style-type: none">1. Video control board2. DC control board
74 SERVICE	<p>A power-up error is detected in the M-CPU.</p> <p>Swap the following components until the message clears:</p> <ol style="list-style-type: none">1. Video control board2. DC control board
75 SERVICE	<p>A signaling or communication problem has occurred between the dc and video control boards. The <i>VSREQ</i> signal is asserted, while the <i>PRINT</i> signal is not.</p> <p>Swap the following components until the message clears:</p> <ol style="list-style-type: none">1. Video control board2. DC control board
76-79	Not used.
80 SERVICE	<p>No STATUS signal after the COMMAND signal.</p> <p>Swap the following components until the message clears:</p> <ol style="list-style-type: none">1. Video control board2. DC control board
81 SERVICE	<p>A COMMAND or STATUS signal parity error is detected.</p> <p>Swap the following components until the message clears:</p> <ol style="list-style-type: none">1. Video control board2. DC control board

Table 3-4 (Cont.): Service Messages

Number Message	Description and Action
82 SERVICE	<p>Bit 3 of the printer status bit is a 1.</p> <p>Swap the following components until the message clears:</p> <ol style="list-style-type: none">1. Video control board2. DC control board
83 SERVICE	<p>Bit 7 of the printer status bit is a 1.</p> <p>Swap the following components until the message clears:</p> <ol style="list-style-type: none">1. Video control board2. DC control board
84 SERVICE	<p>This is a timeout error. The video control board has failed to transmit one page of video to the dc control board.</p> <p>Swap the following components until the message clears:</p> <ol style="list-style-type: none">1. Video control board2. DC control board
85 SERVICE	<p>This is a timeout error. The \overline{VSREQ} signal was not asserted after the \overline{PRINT} signal.</p> <p>Swap the following components until the message clears:</p> <ol style="list-style-type: none">1. Video control board2. DC control board
86 SERVICE	<p>An illegal command or status is detected.</p> <p>Swap the following components until the message clears:</p> <ol style="list-style-type: none">1. Video control board2. DC control board

Table 3-4 (Cont.): Service Messages

Number Message	Description and Action
87 SERVICE	The video control board is connected with a foreign engine. Swap the following components until the message clears: <ol style="list-style-type: none">1. Video control board2. DC control board
A0-FF SERVICE	Video control board internal error. Replace the video control board.

3.4 Troubleshooting Paper Jam and Feed Faults

This section is the fault isolation procedure (FIP) for correcting paper jam problems in the DEClaser 2100 printer.

Refer to Section 1.3.2 for information about the rollers, sensor, and the shape of the paper path.

3.4.1 Jam Troubleshooting Start FIP

FIP NOTES: *This section of the FIP is used to repair a printer that jams or displays jam symptoms. Start your troubleshooting at Figure 3-3, which will direct you to one of the following specific subsections:*

- *Section 3.4.1 for jam indications that occur at power-up or occur spontaneously. These indications are sometimes called phantom jams because there is no sheet of paper in the paper path.*
- *Sections 3.4.2–3.4.5 for jams that occur in areas 1, 2, or 3 that are inside the printer. Figure 3-4 shows the location and boundaries of the three areas.*

Figure 3-3: Jam Start FIP

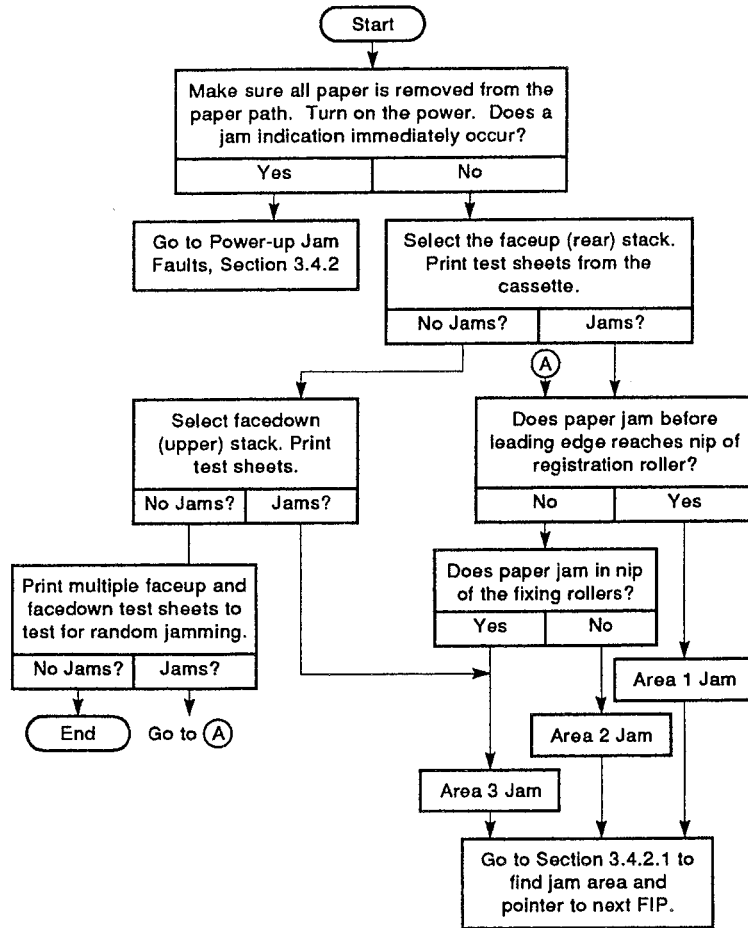

MLO-004922

3.4.1.1 Paper Path Jam Areas

FIP NOTES: *This is the second step of the jam FIP. The start jam FIP (Figure 3-3) precedes this step.*

The start jam FIP isolated the jam to a specific area. Use Figure 3-4 to visually locate the areas and turn to the indicated section.

- ❶ Area 1, the pickup roller and cassette, Section 3.4.3
- ❷ Area 2, the registration rollers, Section 3.4.4
- ❸ Area 3, the fixing and output roller, Section 3.4.5

Figure 3-4: 2100 Jam Areas

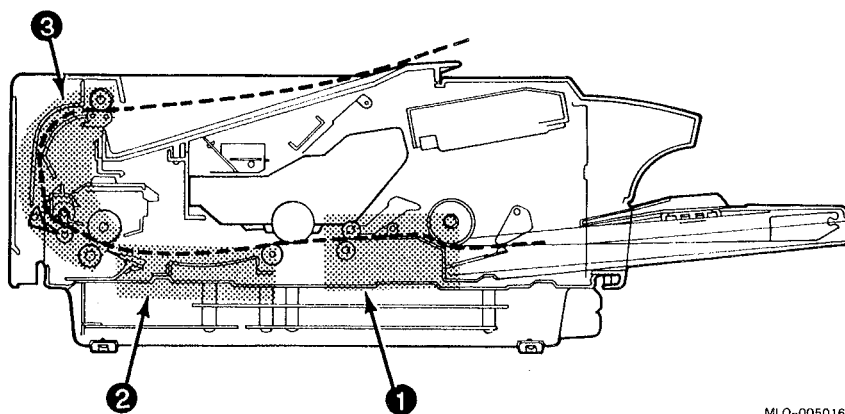

About the Jam Areas Figure 3-4 shows how the paper path is divided into three areas. Always troubleshoot the lowest-numbered areas first, for example, area 1 before area 3. Areas 1, 2, and 3 are named for the rollers that move and control the sheet as it passes through the area. The exit sensor on the fixing unit is the basic cause of all area 1, 2, and 3 jams.

3.4.2 Power-Up Jams

FIP NOTES: *Section 3.4.1, Jam Troubleshooting Start FIP, is the step that precedes this step.*

The following sequence of events defines the power-up jams. Turn to Table 3–5 to fix the power-up jam fault.

1. You examine the paper path and find no paper.
2. You turn the printer power on.
3. The printer goes through the normal period of self-test.
4. The printer beeps and the orange Alarm indicator lights.
5. The 13 PAPER JAM message is displayed along with one or more jam indicators.
6. The jam condition prevents the fixing unit from heating up.

Table 3–5: Power-Up Jams

Power-up jam	<p>All print engine jams are caused by the fixing unit exit sensor. The exit sensor is mounted on the fixing unit and is actuated by the flag linkage. When there is no paper in the fixing unit, gravity pulls down the flag linkage and blocks the sensor.</p> <p>Perform the following steps to fix a power-up jam.</p> <ol style="list-style-type: none">1. Remove the fixing unit, and inspect the exit sensor and the sensor linkage. Clean any dust and pieces of paper from the fixing unit and sensor assembly. Make sure the linkage moves freely. If you find any damage, install a new fixing unit.2. Replace the fixing unit, making sure the 6-pin connectors on the fixing unit and engine baseplate mate correctly. Power on the printer to see if the engine jam is fixed.3. Swap the fixing unit.4. Swap the dc control board.
--------------	---

3.4.3 Area 1 Jams

FIP NOTES: *Section 3.4.1, Jam Troubleshooting Start FIP, is the step that precedes this step.*

Area 1 jams are commonly referred to as misfeeding or misfeeds. An area 1 jam occurs when the pickup roller fails to pick up a single sheet of paper and then to push the leading edge into the nip of the registration rollers. If the registration rollers grasp the sheet, it is an area 2 jam. The dc control board controls the timing of the pickup solenoid, which, when energized, allows the pickup clutch to turn the pickup roller shafts.

Area 1 Timing and Events

Make sure the cassette is fully inserted and the stack lift lever lifts the paper up into the pickup rollers.

When you press **Test/Font**, the following events normally occur:

1. The main motor starts to run.
2. The pickup clutch solenoid pawl lifts, enabling the clutch to turn the pickup shaft and roller.
3. The pickup roller shaft makes one full revolution and stops.
4. The top sheet of paper is picked up and pushed into the paper path toward the registration rollers.
5. The cork surface of the pickup pressure pad eliminates multiple feeds.
6. You can see the paper curl as the leading edge is pushed into the nip of the registration rollers. When the registration rollers turn, the entire length of the leading edge is grasped and the sheet is pulled into the printer.

If performing the above procedure causes jams in area 1, refer to Table 3-6, look up the cause, find the description and recommended course of action.

Table 3-6: Area 1 Jams

Possible Cause	Description and Action
Paper is jammed in the fixing unit.	Fixing unit jams are covered in area 3. Go to Section 3.4.5.
Defective or damaged paper.	<p>Is a recommended type of paper being used? If in doubt, try a standard type of paper to see if jamming continues.</p> <p>Do the following to eliminate any bad paper:</p> <ol style="list-style-type: none">1. Is the cassette overloaded or loaded incorrectly? Remove and fan the paper and reload the cassette.2. The paper may be damp. Select dry paper from the center of a freshly opened package.3. The paper may be damaged. Look for wrinkles. All edges must be straight and sharp, not damaged or dog-eared.4. The paper may be contaminated by adhesives.5. The paper may be compressed during storage. Fan the paper before loading the cassette.
Overloaded or damaged cassettes.	Check the operation of the paper pressure lever and of the pickup roller, and check for obstructions in the paper path.

Table 3–6 (Cont.): Area 1 Jams

Possible Cause	Description and Action
Multiple or shingle feeding.	<p data-bbox="588 535 1257 584">Multiple or shingle feeding can be caused by defective or damaged paper or by a malfunctioning FRU.</p> <p data-bbox="588 602 1257 696">The term <i>multiple feeding</i> means that more than one sheet at a time is fed into the printer. Multiple feeds may not cause a jam indication, but do cause image defects and are bothersome to the customer.</p> <p data-bbox="588 714 1257 835">The term <i>shingle feeding</i> means that the trailing edge of one sheet is overlapped by the leading edge of the next sheet and so on, like roofing shingles. The sheets feed through the printer as one continuous sheet. A jam occurs when the fixing exit sensor fails to detect the trailing edge.</p> <p data-bbox="588 853 1257 902">Check the paper supply and eliminate any of the following problems:</p> <ol data-bbox="588 920 1257 1064" style="list-style-type: none"><li data-bbox="588 920 1059 947">1. Contamination of the paper by adhesives.<li data-bbox="588 965 1257 1014">2. Compression of the paper during storage. Fan the paper before loading the cassette.<li data-bbox="588 1032 874 1059">3. An overloaded cassette. <p data-bbox="588 1081 914 1108">Swap the following components:</p> <ol data-bbox="588 1126 983 1301" style="list-style-type: none"><li data-bbox="588 1126 772 1153">1. Pressure pad<li data-bbox="588 1171 983 1198">2. Pickup roller and clutch assembly<li data-bbox="588 1216 903 1243">3. Solenoid and sensor board<li data-bbox="588 1261 810 1288">4. DC control board

Table 3–6 (Cont.): Area 1 Jams

Possible Cause	Description and Action
Cassette pickup failure.	<p>Remove the top cover and find the pickup clutch and solenoid at the end of the pickup roller shaft. Perform test feeds and observe the operation of the pickup roller and clutch.</p> <ul style="list-style-type: none">• Do the following if the pickup roller turns but does not fully feed paper:<ol style="list-style-type: none">1. Inspect the surface of the pickup roller. If you find any dirt or contamination, replace the pickup roller assembly. Do not disassemble or clean the assembly.2. Swap the pickup roller and clutch assembly.3. Swap the sensor and solenoid board.4. Swap the dc control board.• If the gears that drive the clutch do not turn after Test/Font is pressed, inspect the condition of and swap the following components:<ol style="list-style-type: none">1. DC control board2. Transfer drive assembly3. Intermediate gear assembly4. Main motor assembly5. Sensor and solenoid board6. Pick-up roller and clutch assembly
Paper jammed under the registration rollers.	Registration roller jams are covered in area 2. Go to Section 3.4.4.

3.4.4 Area 2 Jams

FIP NOTES: *Section 3.4.1, Jam Troubleshooting Start FIP, is the step that precedes this step.*

For a valid area 2 jam to exist, the jam must occur between the entrances of the registration and fixing unit rollers. If you determine that the paper never reached the registration rollers, return to Section 3.4.3. If the leading edge advances through the fixing unit rollers, turn to Section 3.4.5.

Area 2 Timing and Events

The following sequence of events occurs in area 2:

1. The registration rollers start, grasp the leading edge, and pull the sheet through the registration rollers.
2. The sheet is pushed across the transfer and static eliminator charge wires. The action of the transfer charger leaves a strong residual charge on the sheet. The residual charge can cause separation failure or the sheet tends to stick to the OPC drum or parts of the EP-S cartridge. The static eliminator discharges the residual charge, allowing the sheet to separate from the OPC drum.
3. After separation, the sheet is pushed by the registration rollers and directed by the feed guide roller into and across the feed guide assembly.
4. The feed guide assembly directs the leading edge into the entrance guide of the fixing unit.
5. The fixing unit entrance guides the leading edge into the nip of the heat and pressure rollers of the fixing unit. The fixing unit rollers grasp the leading edge, and the sheet is pulled into the fixing unit.

Table 3–7: Area 2 Jams

Registration roller failure.

The following symptoms are typical of registration roller malfunctions:

- A malfunction of the registration roller clutch or solenoid is indicated if the leading edge is pushed into, but does not go under, the nip of the registration rollers.
- Registration roller surface contamination by grease or bearing malfunction is indicated when the sheet is crumpled and noticeably skewed to one side of the registration rollers.
- A malfunction of the main motor or drive gears is indicated when the paper stops in the middle of the area 2 paper path. The sheet is lying flat, not out of alignment, and the lines of the printer image appear to be compressed.

Do the following to correct a registration roller failure:

1. Check the main motor connector, labeled J3 on the LVPSA.
2. Swap the transfer drive assembly.
3. Swap the solenoid and sensor board.
4. Swap the dc control board.
5. Swap the LVPSA.
6. Swap the main motor.

Table 3-7 (Cont.): Area 2 Jams

Paper path obstruction or separation failure.

The registration rollers tend to push the sheet into an accordion fold when the sheet collides with some object in the paper path.

Do the following to remove the obstruction or fix the separation problem:

1. Remove the EP-S cartridge and inspect it for damage.
 - There should be no toner leakage. Some toner can escape and become deposited on the exterior of the case during normal operation or if many jams have been cleared. Clean up any toner, using the special vacuum or a clean, damp cloth.
 - Briefly flip open the OPC drum shutter. It should move smoothly, open fully, and shut automatically when released. Make sure the hinges and operation levers are undamaged.
 - The EP-S cartridge case should be free of splits, cracks, or impact damage.
2. Swap the EP-S cartridge.
3. Examine the high-voltage spring contacts that connect from the HVPSA connector block to the transfer charge assembly. Replace the HVPSA if the contacts are burnt, pitted, or mangled.
4. Swap the transfer corona assembly.
5. Swap the HVPSA.
6. Swap the dc control board.

Jams occurs in fixing unit.

Replace the fixing unit.

3.4.5 Area 3 Jams

FIP NOTES: *Section 3.4.1, Jam Troubleshooting Start FIP, is the step that precedes this step.*

Area 3 Timing and Events

An area 3 jam involves the fixing unit, fork gate, entrance guides, and output rollers. The paper must first enter and exit the fixing unit. When the paper exits the fixing unit, the fork gate directs the paper up to the output rollers or to the faceup stack. The output rollers push the sheet into the facedown stack.

When the top cover closes, the following three drive gears are meshed:

- A lever on the fixing unit is pressed, which meshes the fixing unit driven gear into the drive gear of the main motor transmission.
- The exit assembly is first pushed by the top cover, then pulled closed by the two coil springs. When the exit assembly is fully closed, the exit roller drive gear meshes with the gear train in the fixing unit.
- The output rollers are driven by the output drive gears. When the top cover closes, the output drive gear assembly meshes with the drive gear on the top of the fixing unit.

Table 3–8 describes area 3 jam symptoms and gives a course of action for repairing the malfunction.

Table 3–8: Area 3 Jams

Possible Cause	Description and Action
Leading edge does not reach the nip of the fixing rollers.	Jam is an area 3 jam fault. Go to Section 3.4.4.
Paper jams in the fixing unit.	<p>There are two types of fixing unit jams:</p> <ul style="list-style-type: none"> • The sheet of paper is pushed fully into the nip, but the fixing rollers fail to turn and grasp the leading edge. • The sheet collides with an obstruction in the fixing unit or the exit rollers or stripper fingers fail. <p>Do the following to repair either problem:</p> <ol style="list-style-type: none"> 1. Remove and thoroughly inspect the fixing unit. Clean out any shreds of paper, and if you find any damage, install a new fixing unit. Make sure the exit assembly closes fully. 2. Swap the fixing unit. 3. Swap the main motor assembly.
Paper is misdirected, colliding with the fork gate or entering the incorrect output stack.	<p>The fork gate is actuated by mechanical linkages that connect to the hinged door of the faceup stack. When the door is open, the forkgate directs paper into the faceup stack. When the door is closed, the fork gate sends paper into the entrance guides of the output rollers.</p> <p>Inspect the operation of the fork gate and faceup stack. Repair or replace any damaged components.</p>
Jams occur at the entrance to the output rollers.	<p>Open the top cover and examine the entrance guide and fixing unit hold-down plate. Replace any parts that show signs of damage, obstruction, or contamination.</p>

Table 3–8 (Cont.): Area 3 Jams

Possible Cause	Description and Action
Output rollers.	<p>Do the following if the output rollers do not turn or if they cause jams:</p> <ol style="list-style-type: none"><li data-bbox="651 629 1272 712">1. Closely inspect and manually turn the output rollers. Replace any components that are damaged, badly worn, or not functioning.<li data-bbox="651 725 1272 779">2. Swap the fixing unit if the last step shows that the output rollers and drive gears function correctly.<li data-bbox="651 792 1034 824">3. Swap the output roller assembly.

3.5 Troubleshooting Image Defects

You must evaluate the quality of the printed image whenever you service the DEClaser 2100 printer. Obtain one or several copies of Test Print B. Inspect the test prints for satisfactory print image quality.

Table 3-9 describes symptoms and gives a course of action for fixing the image defects.

Table 3-9: Image Defect Lookup Table

Symptom	Description and Action
Light printing.	<p>The text and dark areas of the printed image are too light. Inspect the following elements and replace if damaged:</p> <ul style="list-style-type: none">• The transfer corona assembly• The connectors of the HVPSA and EP-S cartridge• The levers that actuate the drum sensitivity switches on the solenoid and sensor board <p>Swap the following FRUs to correct the problem:</p> <ol style="list-style-type: none">1. EP-S cartridge2. HVPSA3. Scanner assembly4. Solenoid and sensor board5. DC control board

Table 3–9 (Cont.): Image Defect Lookup Table

Symptom	Description and Action
Dark printing.	<p>The printed text is too dark and heavy.</p> <p>Inspect the following elements and replace if damaged:</p> <ul style="list-style-type: none">• The connectors of the HVPSA and EP-S cartridge• The levers that actuate the drum sensitivity switches on the solenoid and sensor board <p>Swap the following FRUs to correct the problem:</p> <ol style="list-style-type: none">1. EP-S cartridge2. HVPSA3. Scanner assembly4. Solenoid and sensor board5. DC control board

Table 3–9 (Cont.): Image Defect Lookup Table

Symptom	Description and Action
The sheet is completely blank.	<p>The sheet is completely white; no toner is printed on the sheet.</p> <p>Inspect the following elements and replace if damaged:</p> <ul style="list-style-type: none">• If the EP-S cartridge was recently installed, check that the toner seal was completely removed.• The EP-S drum light cover. It should completely retract.• The actuation tag that operates the beam shutter lever of the scanner assembly should not be damaged.• The HVPSA connections to the EP-S cartridge and transfer corona assembly. <p>Swap the following FRUs to correct the problem:</p> <ol style="list-style-type: none">1. EP-S cartridge2. HVPSA3. Transfer corona assembly4. Scanner assembly5. DC control board
Large blotchy white areas.	<p>This symptom occurs when the OPC drum has been exposed to strong light, or if the toner in the EP-S cartridge is damp. Storing the EP-S cartridge in cold temperatures or high humidity causes toner to become damp.</p>
All black.	<p>The entire image area is black. Inspect the connectors of the HVPSA and EP-S cartridge for dirt or damage.</p> <p>Swap the following FRUs to correct the problem:</p> <ol style="list-style-type: none">1. EP-S cartridge2. HVPSA3. DC control board

Table 3–9 (Cont.): Image Defect Lookup Table

Symptom	Description and Action
In-line vertical spots.	<p>Inspect the connection of the HVPSA and the static charge eliminator.</p> <p>Replace the HVPSA.</p>
Dirt (toner) on reverse side of paper.	<p>Inspect the paper path for spilled toner. Thoroughly vacuum and clean the entire paper path, especially the following components:</p> <ul style="list-style-type: none">• Cassette top• Transfer guides• Transfer charge wire• Feed guide• Fixing unit pressure roller <p>Inspect or replace the fixing unit cleaning pad.</p> <p>Inspect the EP-S cartridge for signs of leaking toner.</p>
Vertical black streaks.	<p>The symptoms are caused by a dirty primary charge wire or by failure of the OPC drum or fixing unit. The streak may be visible on the OPC drum or fixing unit.</p> <ol style="list-style-type: none">1. Clean the primary charge wire in the EP-S cartridge.2. Swap the EP-S cartridge.3. Swap the fixing unit cleaning pad.4. Swap the cleaning unit.
Thin black horizontal streaks.	<p>Swap the following FRUs:</p> <ol style="list-style-type: none">1. The EP-S cartridge.2. The scanner assembly.3. The dc control board.

Table 3–9 (Cont.): Image Defect Lookup Table

Symptom	Description and Action
Black, irregular, and smudged vertical lines.	Swap the following FRUs: <ol style="list-style-type: none">1. Clean the primary charge wire.2. Replace the EP-S cartridge.
Black, irregular, and smudged horizontal bands.	Swap the following FRUs: <ol style="list-style-type: none">1. The EP-S cartridge2. The fixing unit cleaning pad or the fixing unit
Blank spots in dark areas.	The paper may be too damp. Try some dry paper from the center of a new package. Swap the following FRUs: <ol style="list-style-type: none">1. The EP-S cartridge2. The HVPSA
Solid white vertical lines in dark areas.	This symptom can be caused by an obstruction in the path of the laser beam or by dirt on the transfer charger. <ol style="list-style-type: none">1. Remove the EP-S cartridge and agitate it in the recommended fashion.2. Clean the transfer wire.3. Use a soft brush to clean the mirror.4. Swap the EP-S cartridge.5. Swap the transfer charger assembly.

Table 3-9 (Cont.): Image Defect Lookup Table

Symptom	Description and Action
Bad leading edge registration.	<p>The image is positioned back from the leading edge of the paper.</p> <ol style="list-style-type: none">1. The cassette may be overloaded with paper.2. If an incorrect type of paper is being used, try a common paper type.3. Inspect the metal parts of the pickup roller clutch. If you find any signs of rust, damage, or distortion, replace the pickup roller assembly.4. Swap the solenoid and sensor board.5. Swap the dc control board.
Bad fixing or fusing.	<p>The text or image can be brushed off or easily rubbed off.</p> <ol style="list-style-type: none">1. If an incorrect type of paper is being used, try a common paper type.2. Swap the fixing unit.3. Swap the dc control board.
Distortion.	<p>The printed image is wavy.</p> <ol style="list-style-type: none">1. Swap the scanner assembly.2. Swap the dc control board.

Chapter 4

DEClaser 2100 Removal and Replacement Procedures and RSL

This chapter contains the recommended spares list (RSL) and describes the removal and replacement procedures for the DEClaser 2100 printer. A typical procedure contains numbered steps to remove a component from the printer. Unless otherwise noted, you reverse the procedure to replace the component. Any step in a procedure can refer you to another procedure.

The RSL identifies the spare parts that are stocked for servicing the printer. If you need a part that is not on the RSL, consult the *DEClaser 2100/2200 Illustrated Parts Breakdown* for the part number or order information.

4.1 Recommended Spares List (RSL)

Table 4-1 gives the recommended spares listing for the DEClaser 2100 printer.

Table 4-1: DEClaser 2100 Recommended Spares List (RSL)

Part Number	Description
29-28270-01 ¹	100/115-Vac ac inlet assembly
29-28270-02 ¹	220/240-Vac ac inlet assembly
29-28281-01 ¹	Main (FM1) fan (mounts on ac inlet assembly)
29-28271-01 ¹	Fan (FM2)
29-28273-01 ¹	High-voltage power supply assembly (HVPSA)
29-28283-01	100/115-Vac fixing unit or assembly
29-28283-02	220/240-Vac fixing unit or assembly
29-28284-01	100/115-Vac LVPSA with attached solenoid and sensor board

¹ This part is interchangeable. The same part number is used for the DEClaser 2100 and 2200 printers.

Table 4-1 (Cont.): DEClaser 2100 Recommended Spares List (RSL)

Part Number	Description
29-28284-02	220/240-Vac LVPSA with attached solenoid and sensor board
29-28274-01 ¹	Laser scanner assembly
29-28275-01 ¹	Input/output board
LN-XX-AC ¹	Toner supplies (EP-S) cartridge kit
29-28314-01 ¹	Miscellaneous screws kit
29-28282-01 ¹	Paper pressure assembly
29-28291-01 ¹	Pickup separation pad
29-28272-01 ¹	Ozone filter
29-28276-01 ¹	Preconditioning lamp assembly
29-28303-01	DEClaser 2100 control panel assembly
29-28285-01	DC control board
29-28304-01	Video control board
29-28277-01 ¹	Transfer corona assembly
29-28286-01	Transfer guide assembly
29-28287-01	Paper feed pickup roller assembly
29-28279-01 ¹	Main motor drive assembly
29-28278-01 ¹	Intermediate gear assembly
29-28280-01 ¹	Main motor assembly
29-28301-01 ¹	Solenoid and sensor board
29-28299-01 ¹	Output roller paper delivery assembly
20-33113-01 ¹	1-MB RAM card
20-32801-01 ¹	2-MB RAM card
20-32802-01 ¹	3-MB RAM card

¹ This part is interchangeable. The same part number is used for the DEClaser 2100 and 2200 printers.

4.2 Top Cover

Use the following procedure to remove and replace the top cover of the DEClaser 2100 printer.

1. Open the top cover.
2. Remove the EP-S cartridge as shown in Section 4.6.
3. Disengage the upper spring from the bracket.
4. Remove the screw that holds the left guard plate and remove the guard plate.

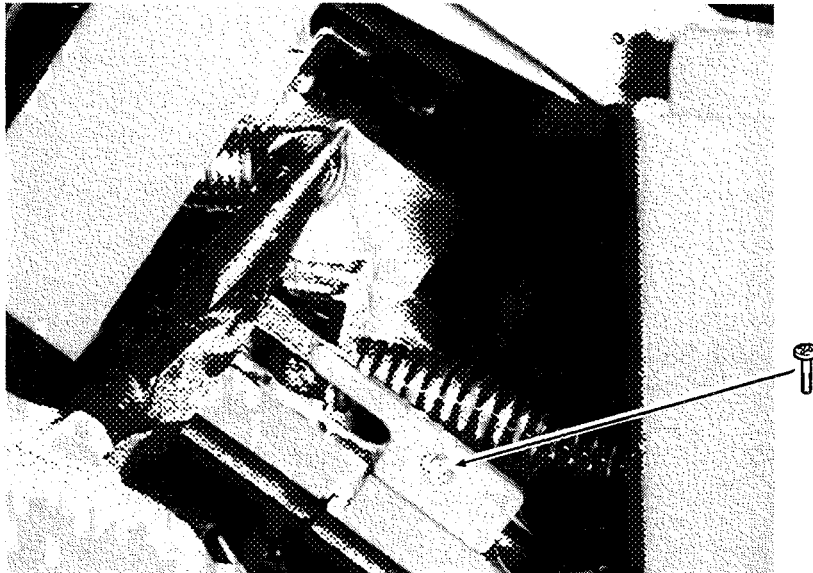

MLO-004596

5. Remove the screw that holds the right guard plate and remove the guard plate.
6. Disengage both springs from the slots.
7. Park both springs in the up position, for access to the hinge screws.



MLO-004597

8. Remove the four screws that hold the hinge to the top cover, then remove the cover.

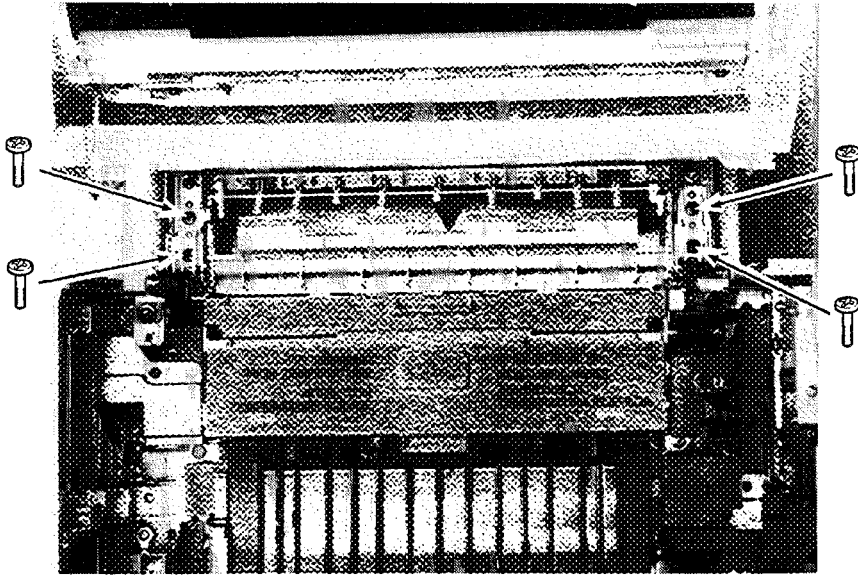

MLO-004598

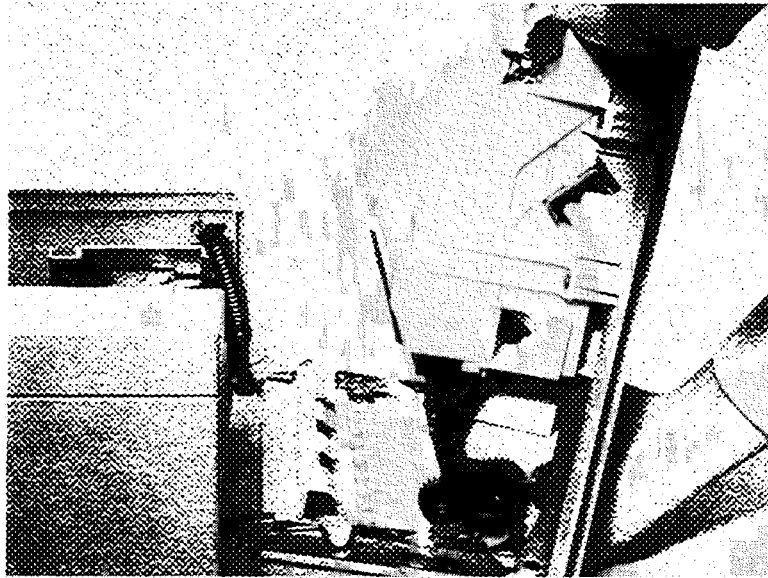

MLO-004599

4.2.1 Top Cover Mirror

Use the following procedure to remove and replace the top cover mirror of the DEClaser 2100 printer.

1. Remove the EP-S cartridge as shown in Section 4.6.
2. Remove the three screws that hold the shutter to the subframe.
3. Lift and remove the shutter.
4. Stop here if you intend to clean the mirror. Continue on to remove the mirror.

CAUTION: *Be careful when handling the mirror. The surface of the mirror is sensitive and is easily scratched or damaged by dirt or oil from your fingers.*

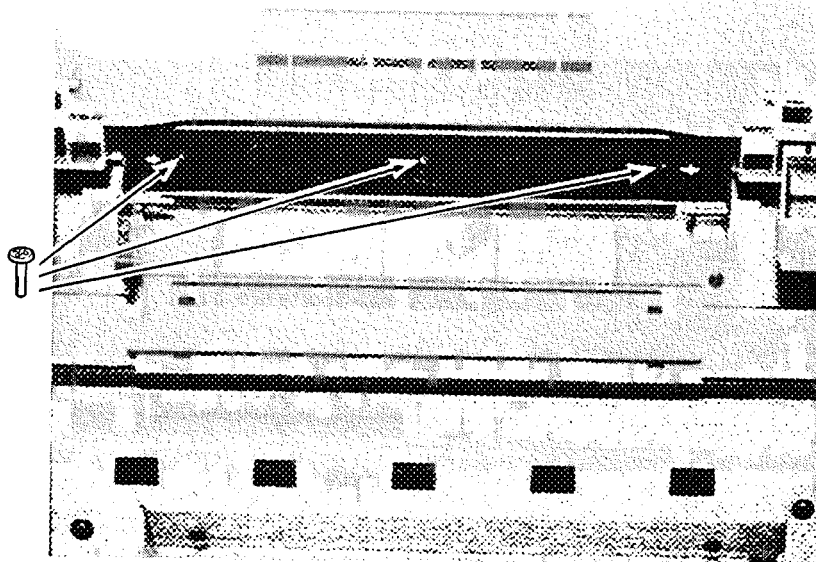

MLG-004600

5. Remove the top cover, as shown in Section 4.2, and place it upside down on a work surface.
6. Remove the two screws from the fixing unit hold-down plate.
7. Remove the fixing unit hold-down plate.

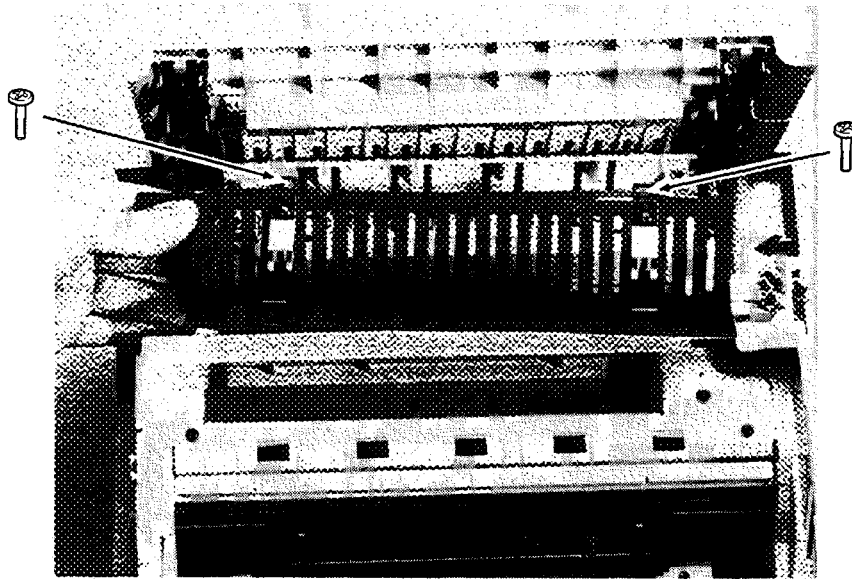

MLO-004601

8. Remove the six screws that hold the subframe to the top cover.

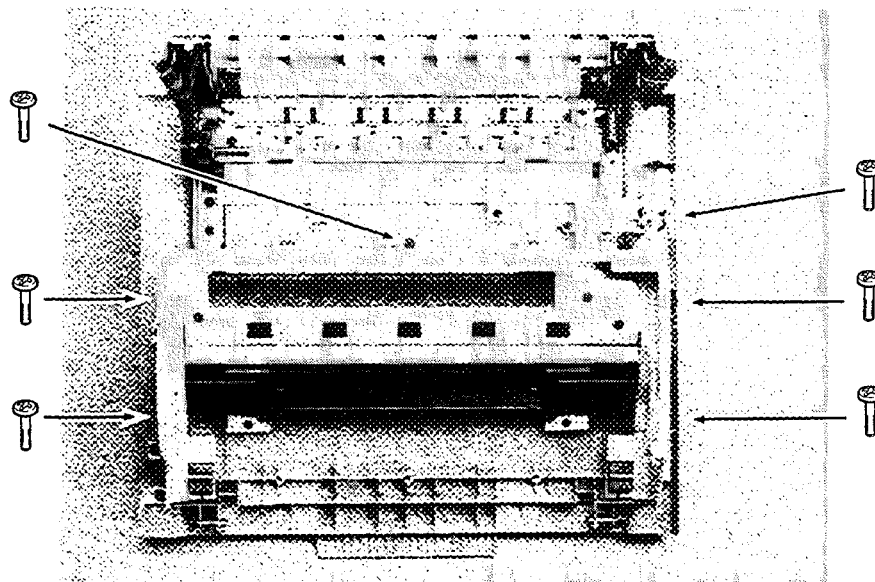

MLO-004602

9. Hold the mirror to the subframe, as shown, while you lift and remove the subframe.

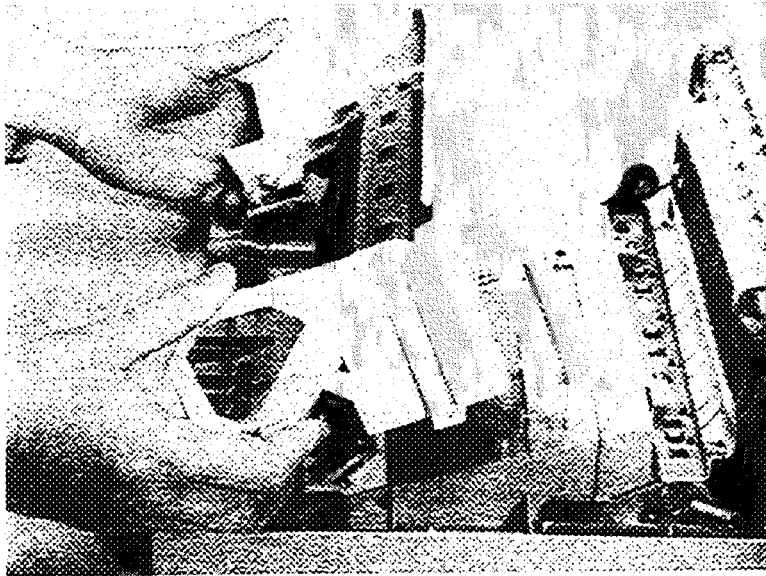

MLO-004603

10. Place the subframe on a work surface, as shown below.

11. Remove the mirror from the guide posts.

The mirror mounting holes and subframe posts are two different sizes. After you mount the mirror, make sure the mirror is free to move up and down on the subframe posts and site correctly.

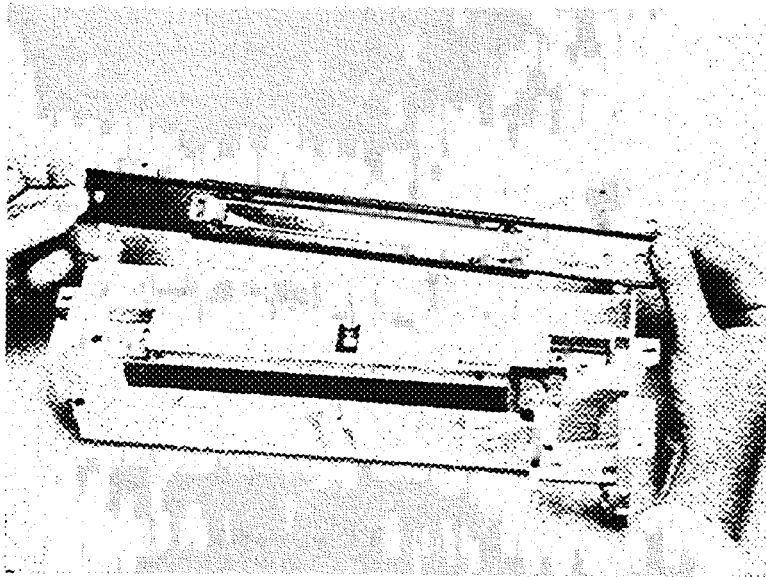

MLO-004604

4.2.2 Top Cover Switch Lever

Use the following procedure to remove and replace the switch lever that is mounted on the top cover. When the top cover is closed, the switch lever depresses the interlock switches.

1. Open the top cover.
2. Remove the screw that holds the switch lever to the top cover, and remove the switch lever.

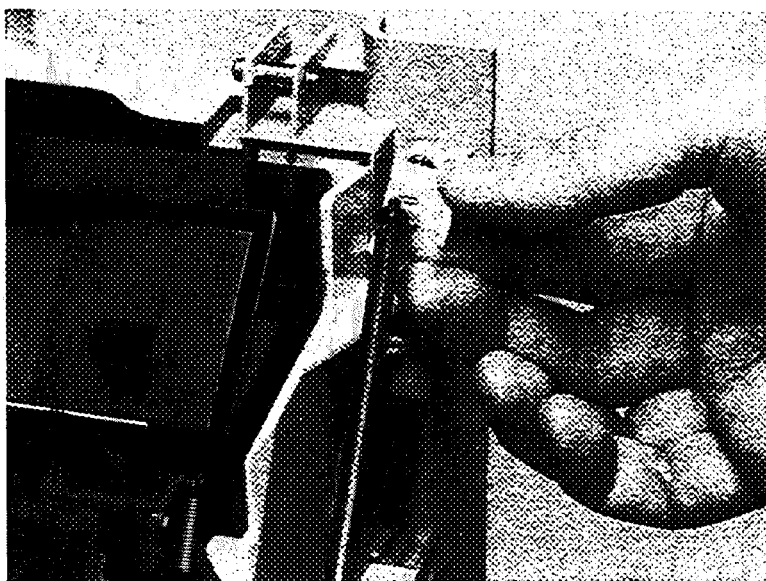

MLO-004605

4.3 Ozone Filter

Use the following procedure to remove and replace the ozone filter of the DEClaser 2100 printer.

1. Open the top cover.
2. Use a fingernail to pry open the hatch.
3. Grasp the tab and pull out the ozone filter.

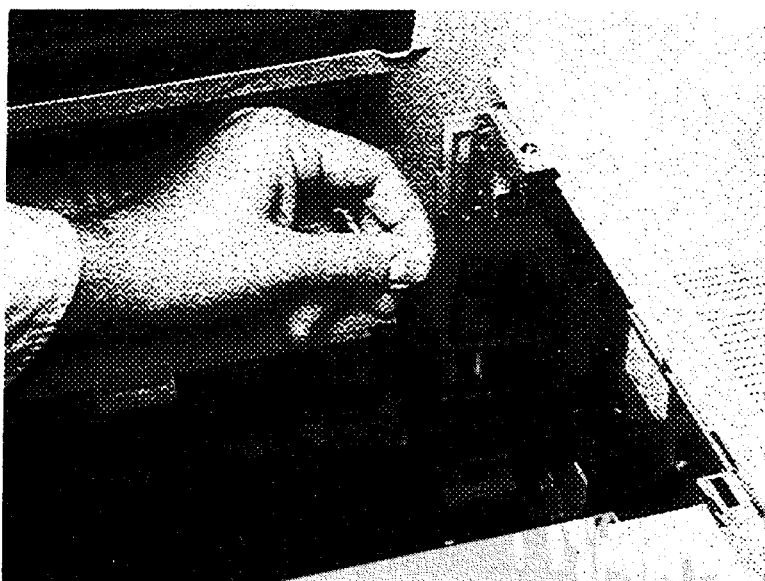

MLO-004606

4.4 Upper Cover

Use the following procedure to remove and replace the upper cover of the DEClaser 2100 printer.

1. Open the top cover.
2. Remove the EP-S cartridge as shown in Section 4.6.
3. If a paper cassette is installed, remove it.
4. Remove the five screws as shown below.

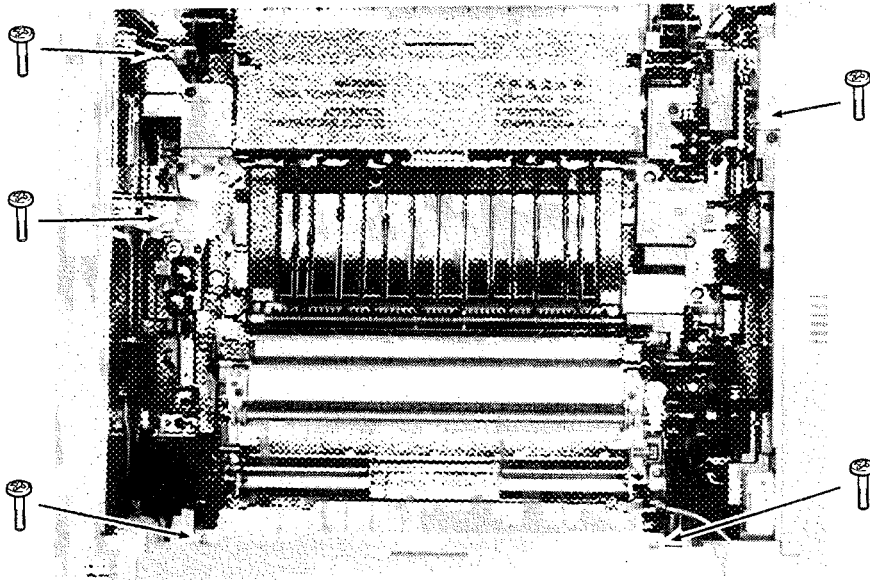

MLO-004607

5. Remove the two side screws.
6. Remove the single rear screw.

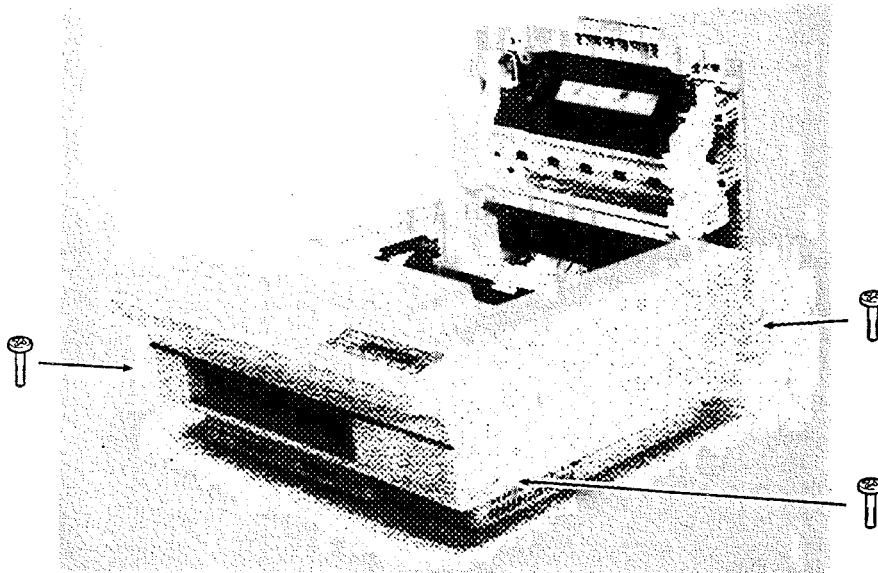

MLO-004608

7. Partially withdraw the upper cover until the control panel connector is accessible.
8. Disconnect the control panel connector.

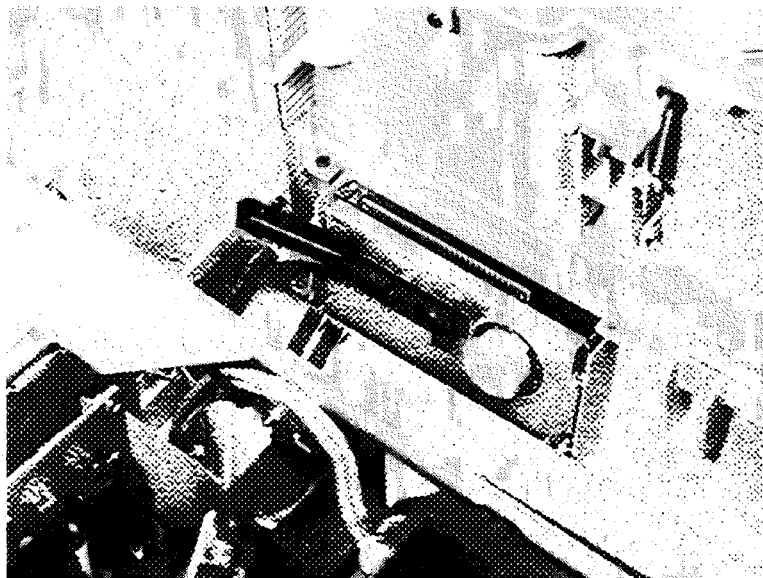

MLO-004609

9. Remove the upper cover.

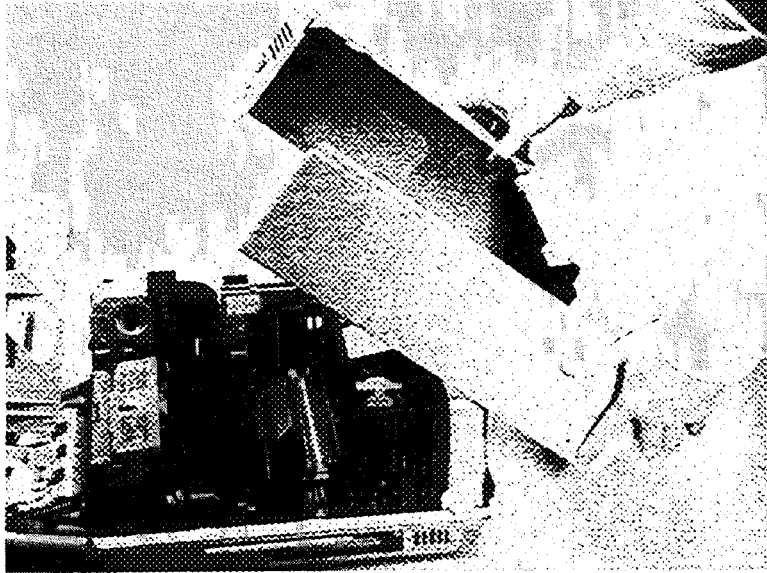

MLO-004997

4.4.1 Front Subpanel

Use the following procedure to remove and replace the front subpanel of the DEClaser 2100 printer.

1. Remove the upper cover as shown in Section 4.4.
2. Remove the screw that holds the ground wire to the front subpanel.
3. Open the cable clamp **1** and remove the cables.

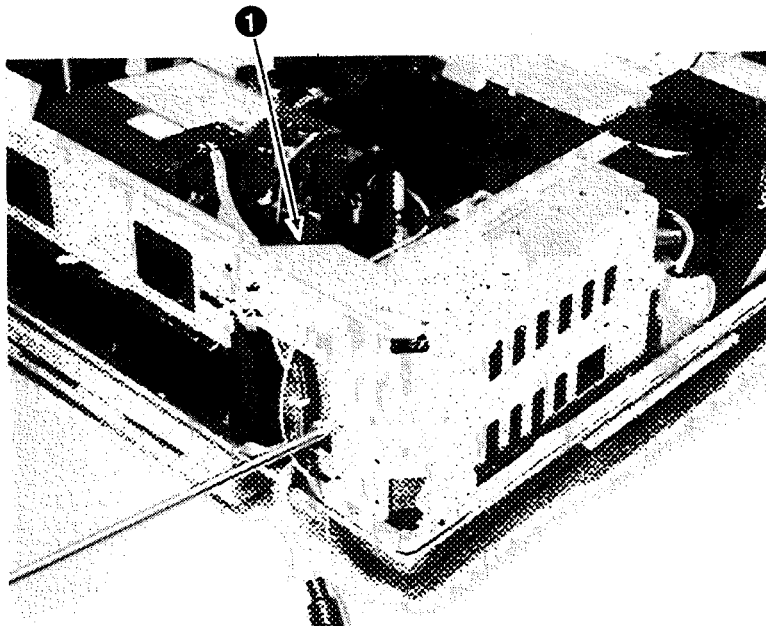

MLO-004610

4. Remove the three left-side screws.
5. Remove the three right-side screws.

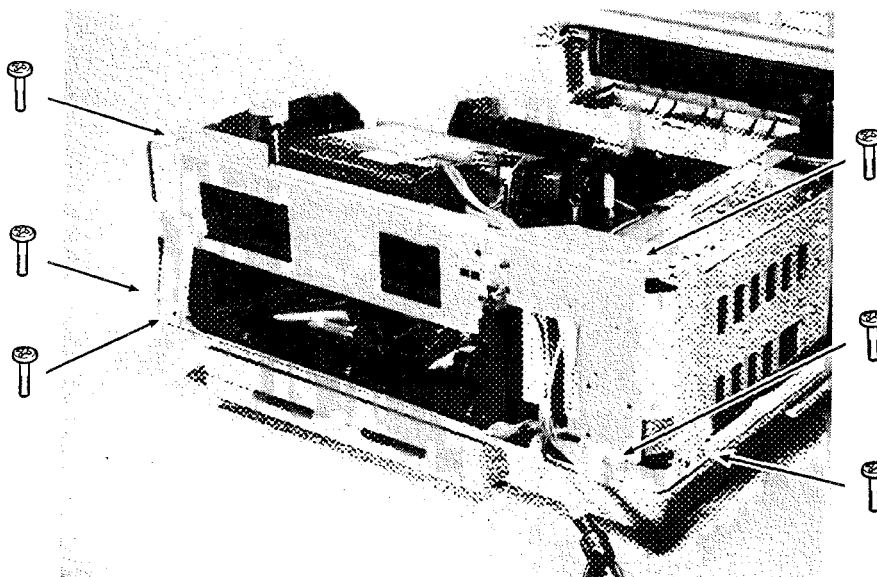

MLO-004611

6. Remove the front subpanel. When you replace the subpanel, make sure the electrical and fiber-optic cables are routed correctly.

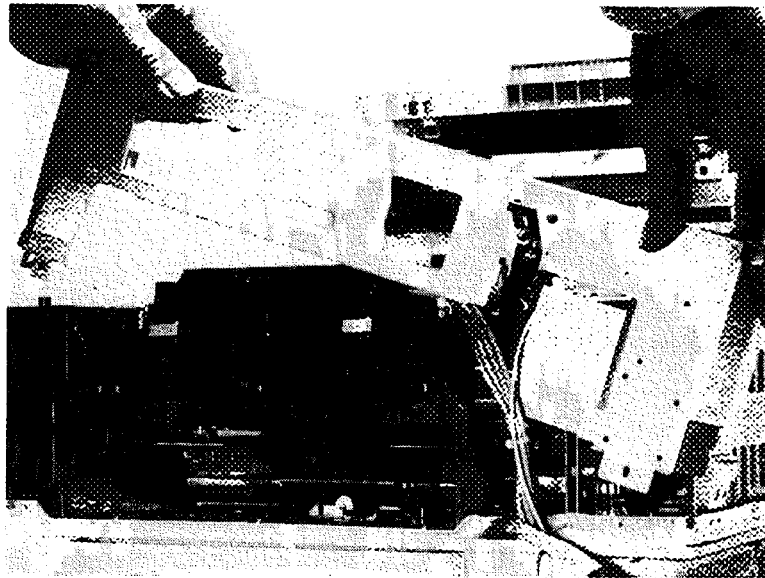

MLO-004612

4.5 Bottom Cover

Use the following procedure to remove and replace the bottom cover of the DEClaser 2100 printer.

CAUTION: Do not attempt to operate the printer with the bottom cover removed.

1. Remove the paper cassette.
2. Remove the EP-S cartridge as shown in Section 4.6.
3. Remove any connectors from the serial or parallel port connectors.
4. If installed, remove the optional RAM expansion board as shown in Section 4.9.
5. Turn the printer upside down and lay it on its top cover.
6. Remove the eight screws that hold the bottom cover.

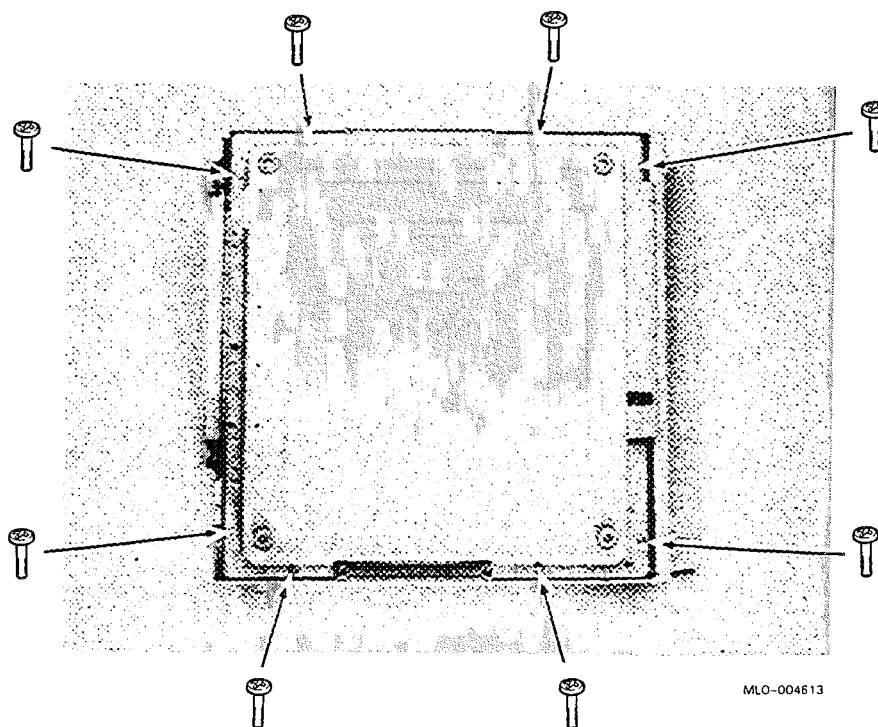

7. Remove the bottom cover.

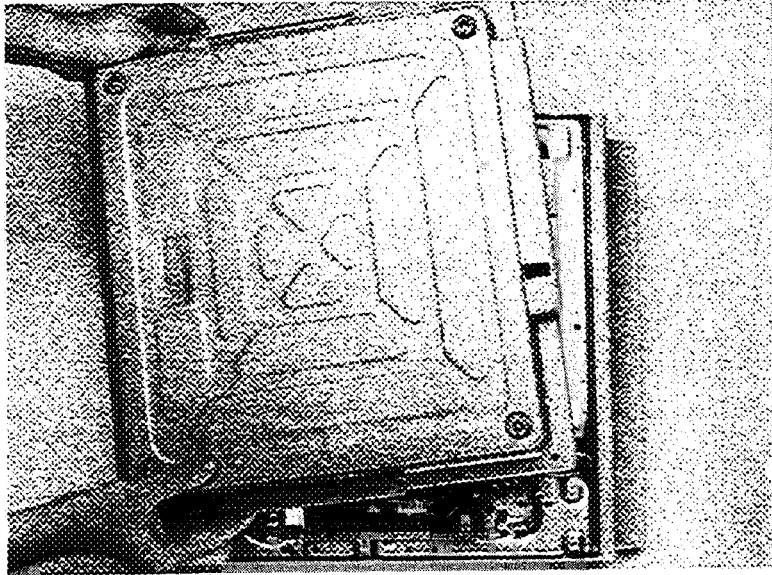

MLC-004614

4.5.1 Font Cartridge Guides

Use the following procedure to remove and replace the font cartridge guides of the base cover of the DEClaser 2100 printer.

1. Remove the bottom cover as shown in Section 4.5.
2. Remove the three screws that hold the font cartridge guides to the bottom cover, and remove the font cartridge guide assembly.

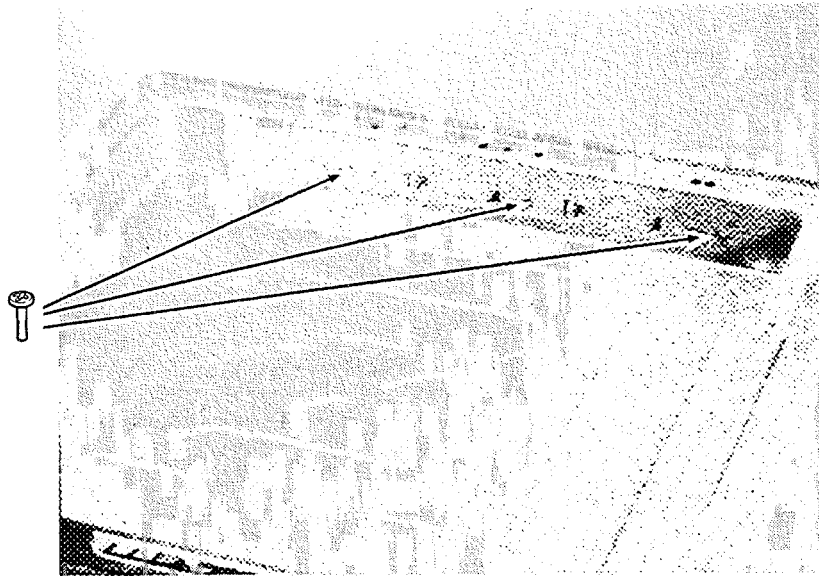

MLO-004615

4.6 EP-S Cartridge

Use the following procedure to remove and replace the EP-S cartridge in the top cover of the DEClaser 2100 printer.

1. Open the top cover.
2. Remove the EP-S cartridge as shown. Do not stand the cartridge on either end or touch the OPC drum.

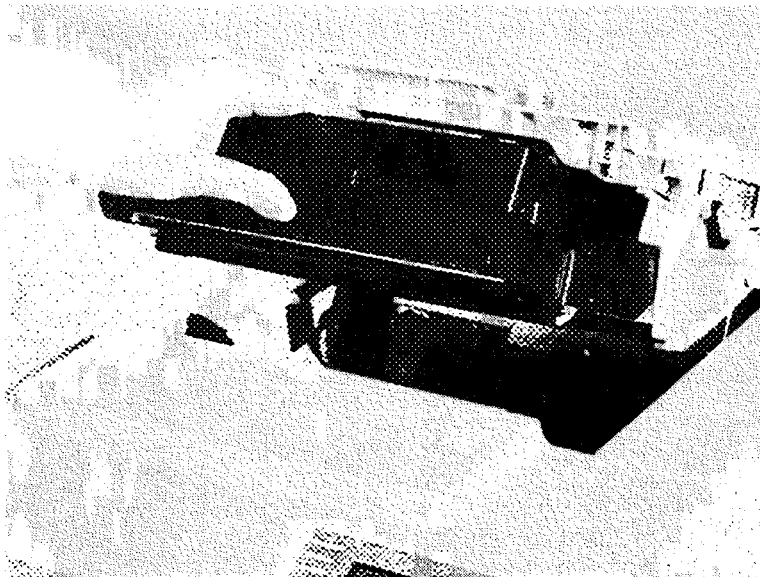

MLO-004616

4.7 Input/Output (I/O) Board

Use the following procedure to remove and replace the I/O board of the DEClaser 2100 printer. The switchpack mounted on some I/O boards is not used in the field. The correct operational setting for both switches is open.

CAUTION: *Use the standard antistatic equipment and procedures when you handle this sensitive electronic component.*

1. Remove the bottom cover as shown in Section 4.5.
2. Remove the four screws that hold the I/O board to the baseplate.

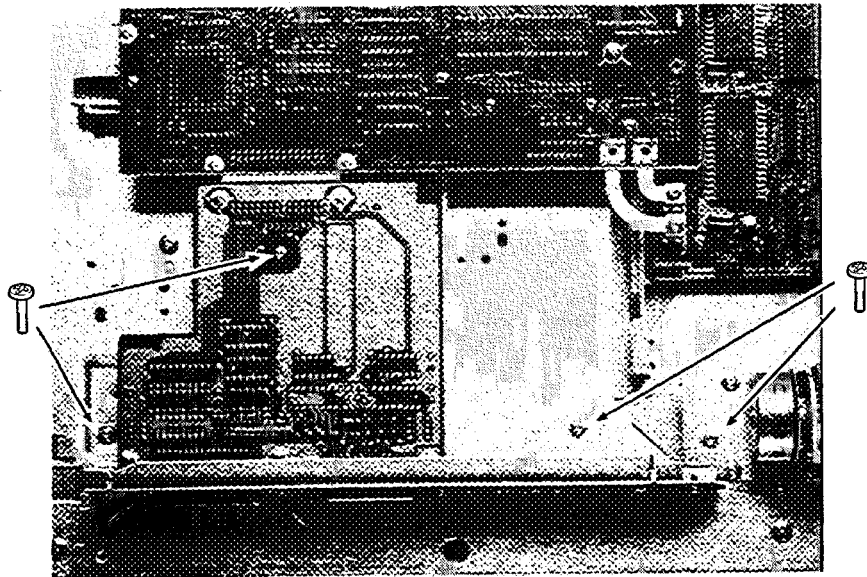

MLO-004617

3. Disconnect the electrical connector to the video control board, and remove the I/O board.

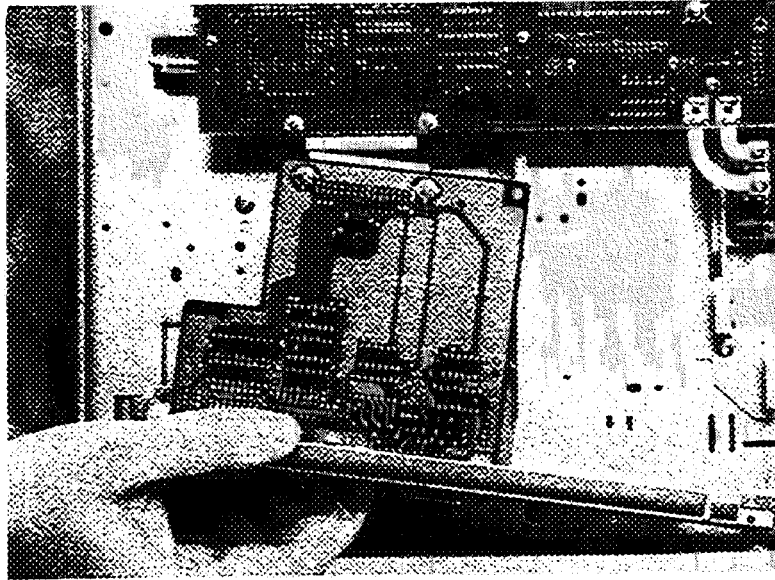

MLO-004618

4.8 Video Control Board

Use the following procedure to remove and replace the video control board of the DEClaser 2100 printer. The early versions of the video control board (as shown in this procedure) has a piggyback ROM board. This memory board will be removed from future versions of the video control board. Both early and later versions are interchangeable.

NOTE: *When you replace a defective video control board, remove the page count IC from the defective board and install it on the new board. This action preserves the page count information that is crucial for contract and accounting information.*

CAUTION: *Use the standard antistatic equipment and procedures when you handle this sensitive electronic component.*

1. Remove the EP-S cartridge bottom cover as shown in Section 4.5.
2. Remove the I/O board as shown in Section 4.7.
3. Remove the two screws connecting the power buses.
4. Disconnect the 34-pin control panel connector.
5. Remove the six screws that hold the video control board to the printer baseplate.

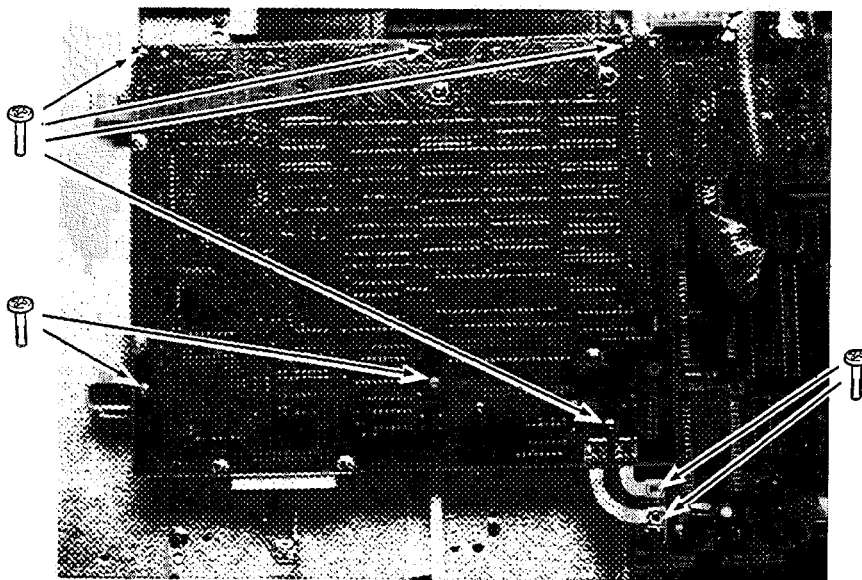

MLO-004619

6. Lift the video control board off the alignment pins and remove the board.
7. If you are replacing the video control board, swap the page count IC as shown in Section 4.8.1.

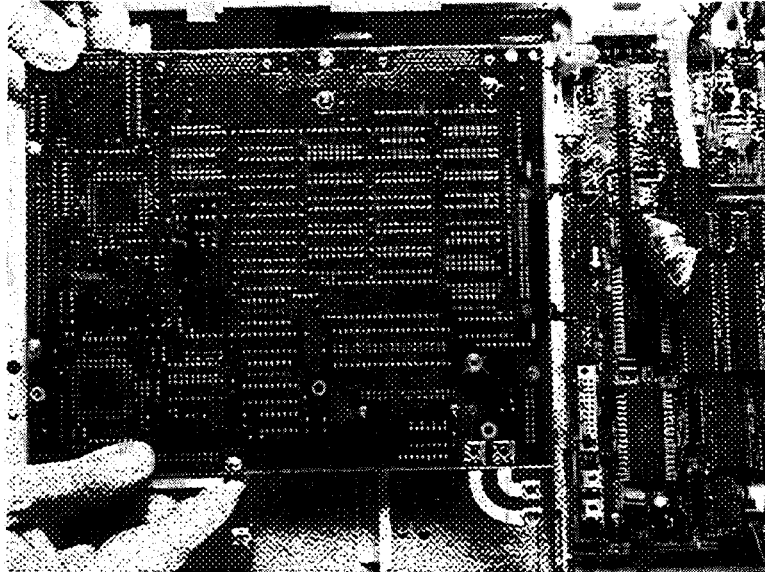

MLO-004620

4.8.1 Page Count IC

Page count information is stored in the page count memory integrated circuit (IC). The page count is the number of pages the printer has printed. When you replace a video control board, you must remove the page count IC from the defective video control board and install it on the new video control board.

CAUTION: *Use the standard antistatic equipment and procedures when you handle this sensitive electronic component.*

Use the following procedure to remove and replace the page count IC of the video control board of the DEClaser 2100 printer.

1. Remove the video control board as shown in Section 4.8.
2. Using a suitable tool, gently pry the page count IC loose from the socket.
3. Remove the page count IC.

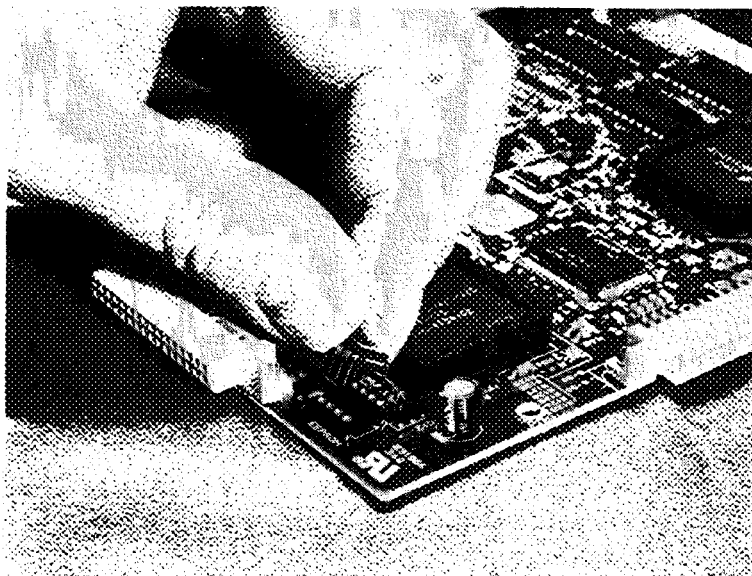

MLO-004621

4.9 RAM Expansion Board

Use the following procedure to remove and replace the optional RAM expansion board of the DEClaser 2100 printer.

CAUTION: *Use the standard antistatic equipment and procedures when you handle this sensitive electronic component.*

1. Remove the screw that holds the RAM board access cover to the bottom cover and remove the panel.
2. Simultaneously lift the handle guides and remove the RAM board.

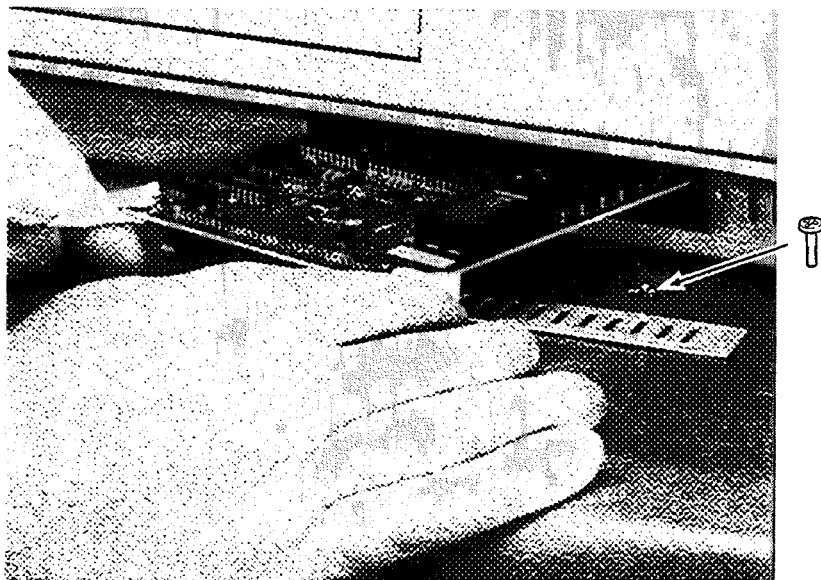

MLO-004624

4.10 DC Control Board

Use the following procedure to remove and replace the dc control board of the DEClaser 2100 printer.

1. Remove the EP-S cartridge bottom cover as shown in Section 4.5.
2. Remove the I/O board as shown in Section 4.7.
3. Remove the video control board as shown in Section 4.8.
4. Loosen the screw that holds the interlock lever assembly.
5. Remove the interlock lever assembly.

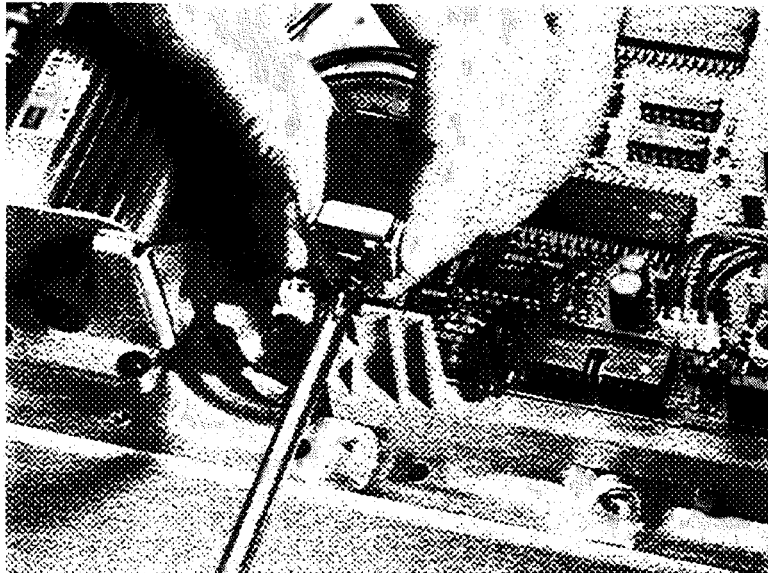

MLO-004625

6. Remove the following connectors:

- ① 7-pin J606
- ② 2-pin J207 FM2
- ③ 4-pin J208
- ④ 8-pin J211
- ⑤ Fiber-optic J201
- ⑥ 7-pin J203
- ⑦ 5-pin J202

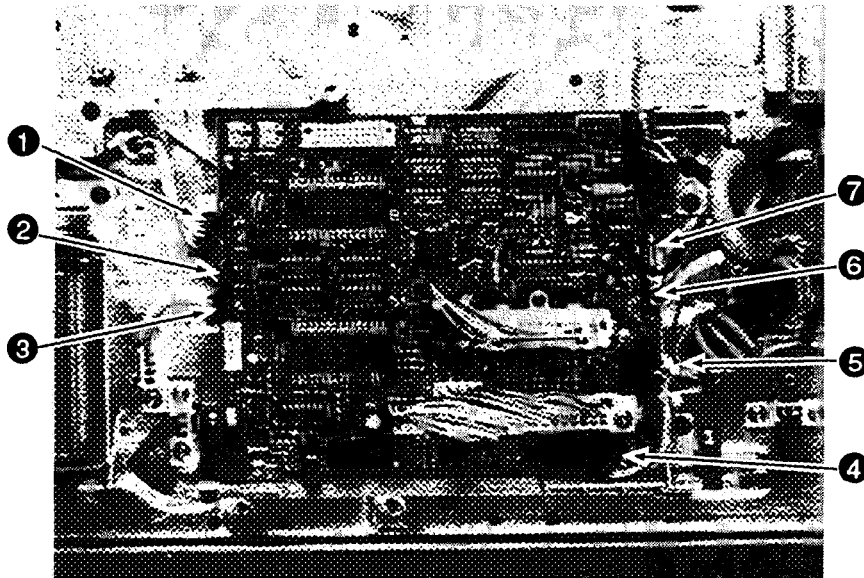

MLO-004626

7. Remove the four shoulder screws that hold connectors J212 and J213 to the dc control board.
8. Unplug J212 and J213 from the dc control board.

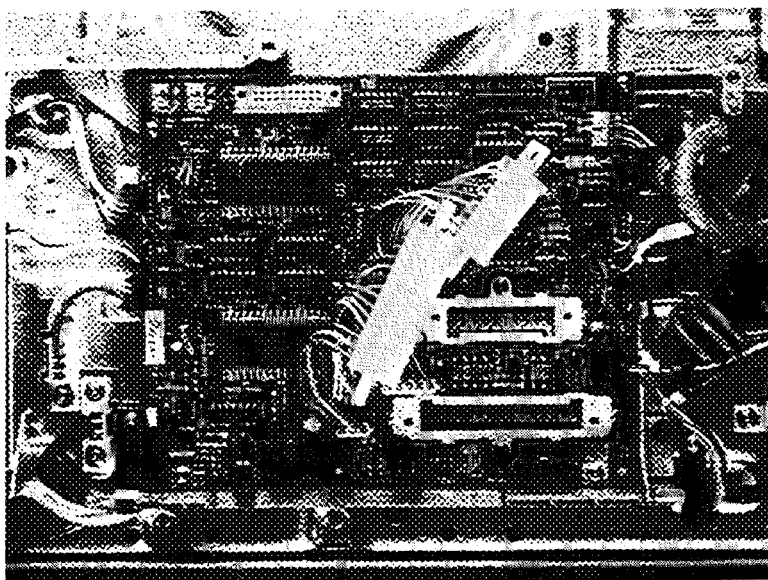

MLO-004627

9. Remove the six screws that hold the dc control board to the baseplate.
10. Lift the dc control board off the alignment pins and remove the board.

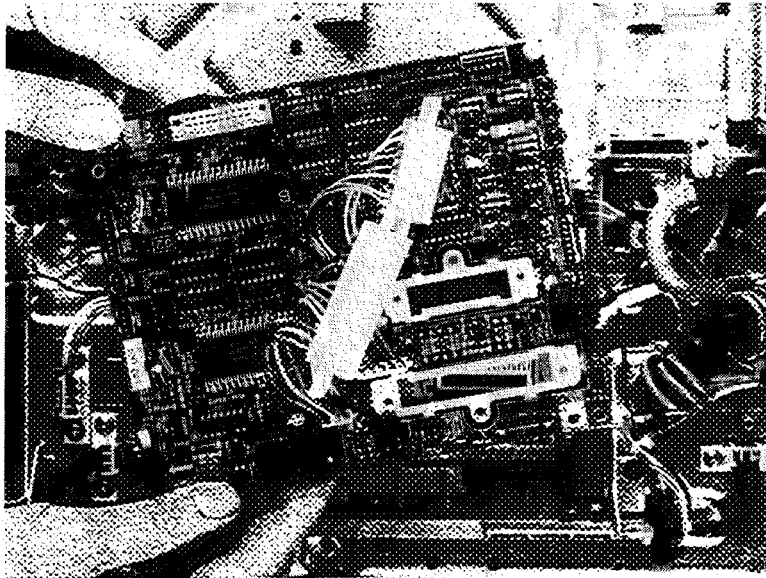

MLO-004628

4.11 Control Panel

Use the following procedure to remove and replace the control panel of the DEClaser 2100 printer.

CAUTION: *Use the standard antistatic equipment and procedures when you handle this sensitive electronic component.*

1. Remove the upper cover as shown in Section 4.4.
2. Push each of the four plastic tabs in turn while you push the control panel out through the front of the upper cover.

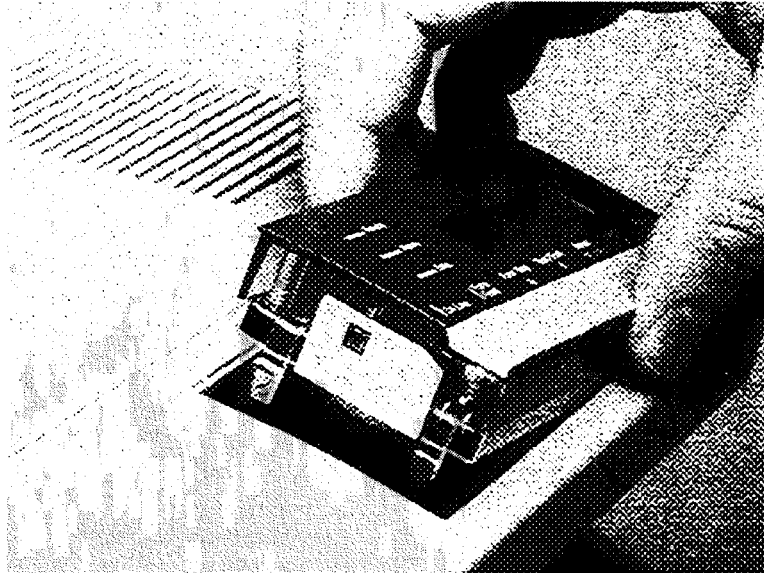

MLO-004629

4.12 High-Voltage Power Supply Assembly (HVPSA)

Use the following procedure to remove and replace the high-voltage power supply assembly (HVPSA) of the DEClaser 2100 printer.

CAUTION: *Use the standard antistatic equipment and procedures when you handle this sensitive electronic component.*

1. Remove the upper cover as shown in Section 4.4.
2. Remove the front subpanel as shown in Section 4.4.1.
3. Remove the four screws that hold the HVPSA to the baseplate.

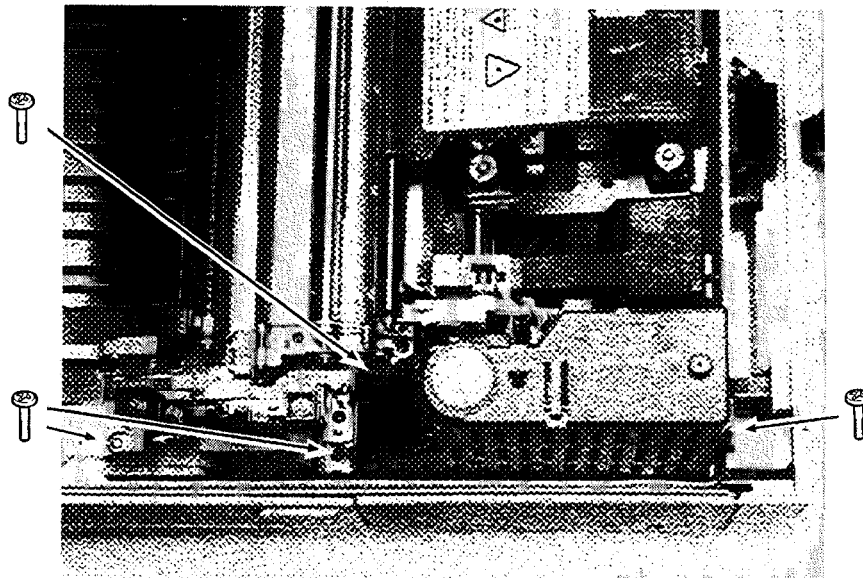

MLO-004630

4. Lift, unplug, and remove the HVPSA and connector block from the baseplate. When you replace the HVPSA, make sure it sits squarely on the alignment pins and on the baseplate of the printer.

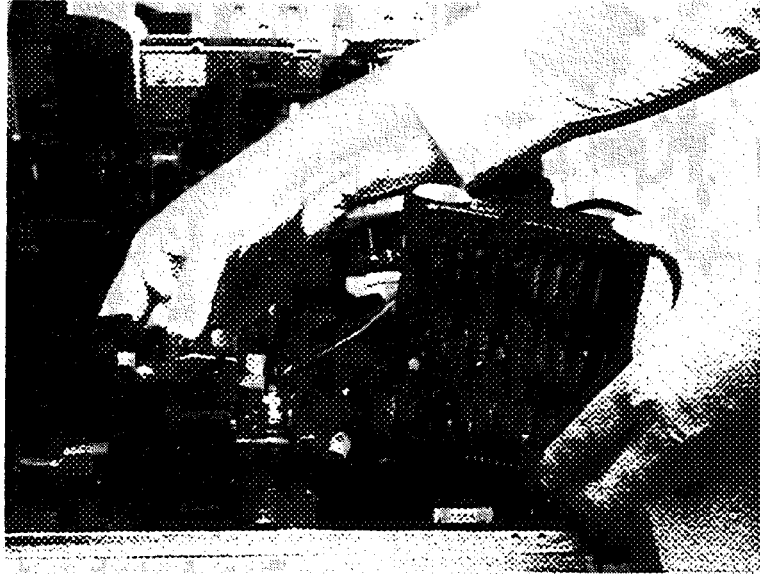

MLO-004631

4.13 Low-Voltage Power Supply Assembly (LVPSA)

Use the following procedure to remove and replace the low-voltage power supply assembly (LVPSA) of the DEClaser 2100 printer.

CAUTION: *Use the standard antistatic equipment and procedures when you handle this sensitive electronic component.*

1. Remove the upper cover as shown in Section 4.4.
2. Remove the front subpanel as shown in Section 4.4.1.
3. Remove the fiber-optic cable from the restraining clamp.

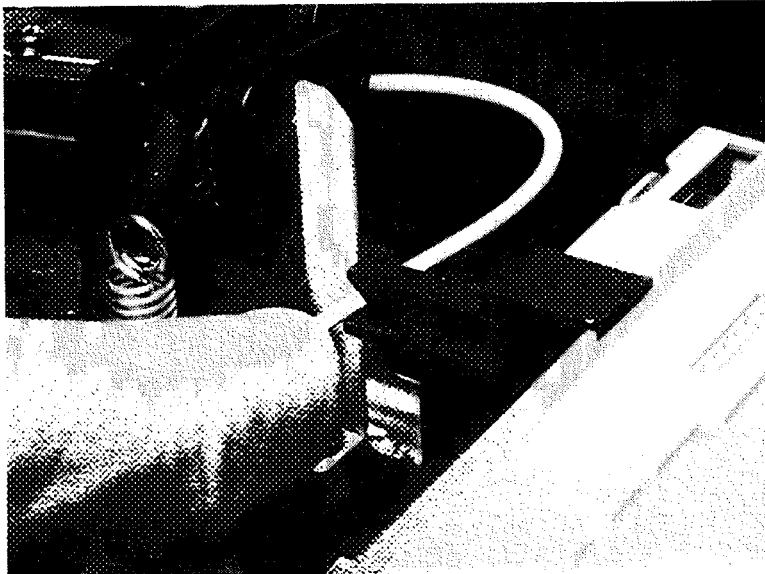

MLO-004632

4. Unplug the main motor cable J3 connector ❶.
5. Remove the three screws that hold the LVPSA to the printer baseplate.

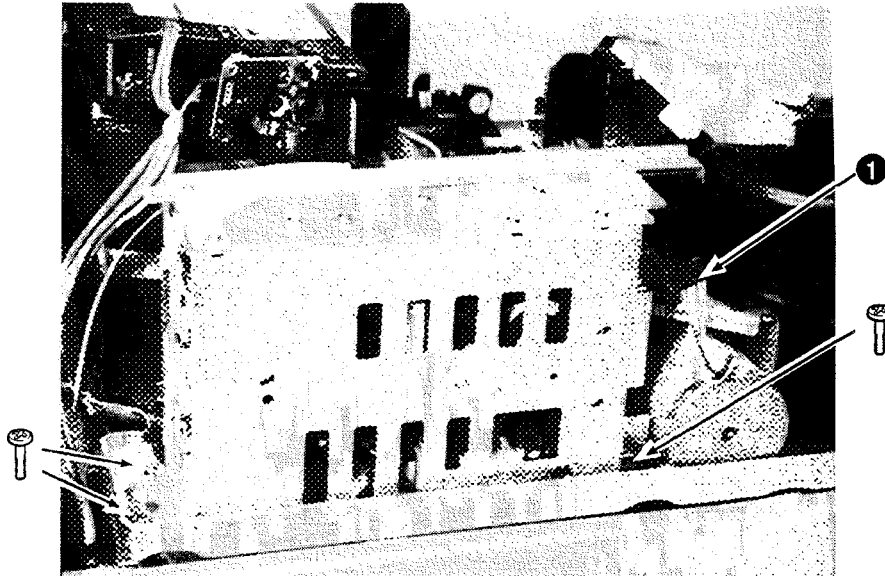

MLO-004633

6. Lift, unplug, and remove the LVPSA from the baseplate.
7. Remove the solenoid and sensor board as shown in Section 4.13.1.

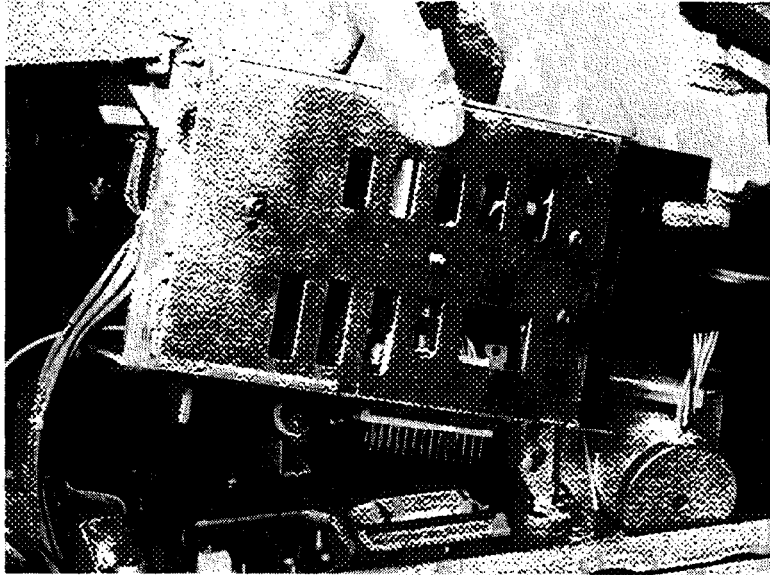

MLO-004634

4.13.1 Solenoid and Sensor Board

Use the following procedure to remove and replace the solenoid and sensor board of the LVPSA of the DEClaser 2100 printer.

CAUTION: *Use the standard antistatic equipment and procedures when you handle this sensitive electronic component.*

1. Remove the LVPSA as shown in Section 4.13.
2. Remove the screw that holds the plastic shield to the LVPSA bulkhead.
3. Remove the plastic shield.

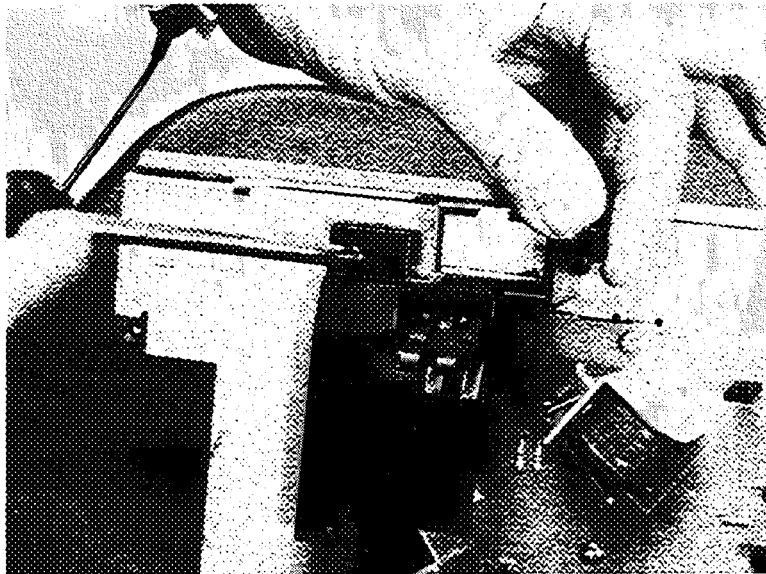

MLO-004635

4. Remove the six screws that hold the board to the LVPSA.

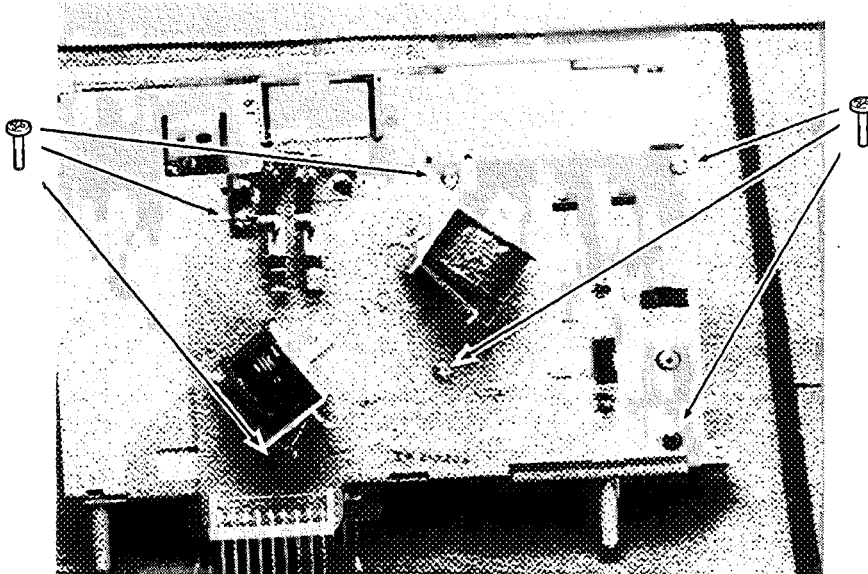

MLO-004636

5. Remove the solenoid and sensor board.

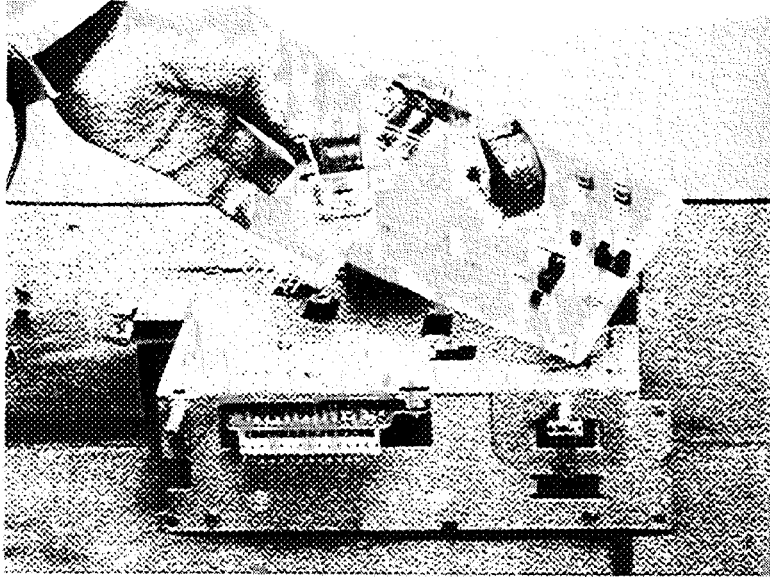

MLO-004637

4.14 Scanner Assembly

Use the following procedure to remove and replace the scanner assembly of the DEClaser printer.

CAUTION: *Use the standard antistatic equipment and procedures when you handle this sensitive electronic component.*

1. Remove the upper cover as shown in Section 4.4.
2. Do the following:
 - ❶ Remove the screw and open the access hatch. Remove the fiber-optic light cable as shown below.
 - ❷ Open the access hatch and unplug the 5-pin J401 connector.
 - ❸ Unplug the 4-pin J451 connector.

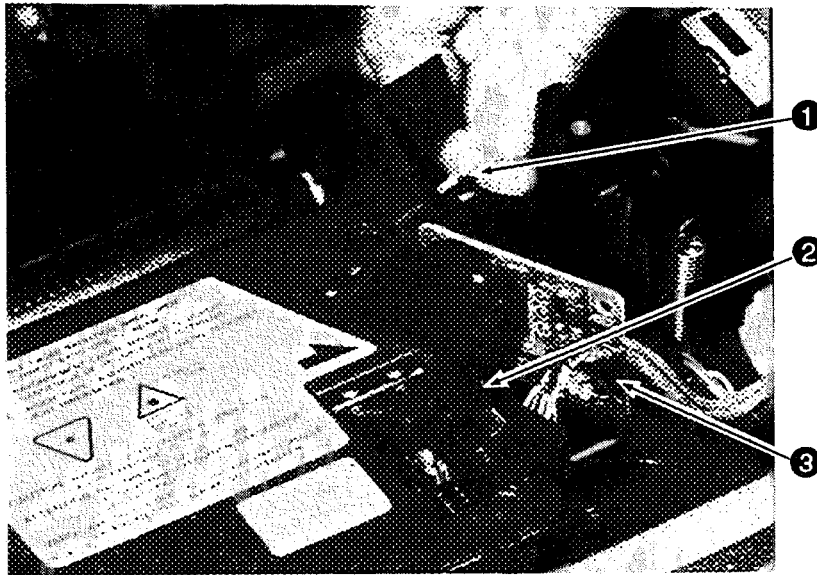

MLO-004639

3. Remove the four mounting screws.
4. Remove the scanner assembly.

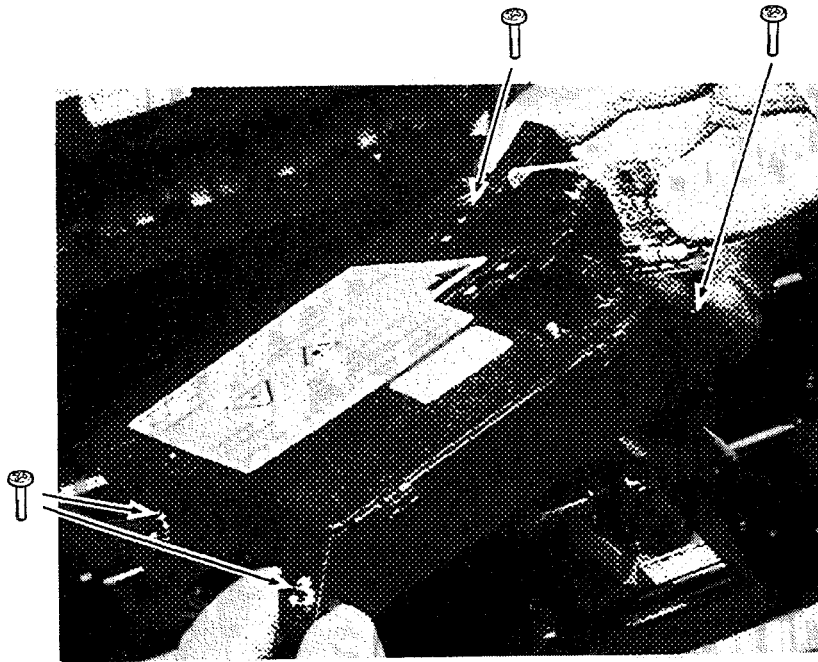

MLO-004640

4.15 Feed Guide Assembly

Use the following procedure to remove and replace the feed guide assembly of the DEClaser 2100 printer.

1. Open the top cover.
2. Remove the fixing unit as shown in Section 4.16.
3. Remove the four screws that hold the assembly to the baseplate.
4. Remove the feed guide assembly.

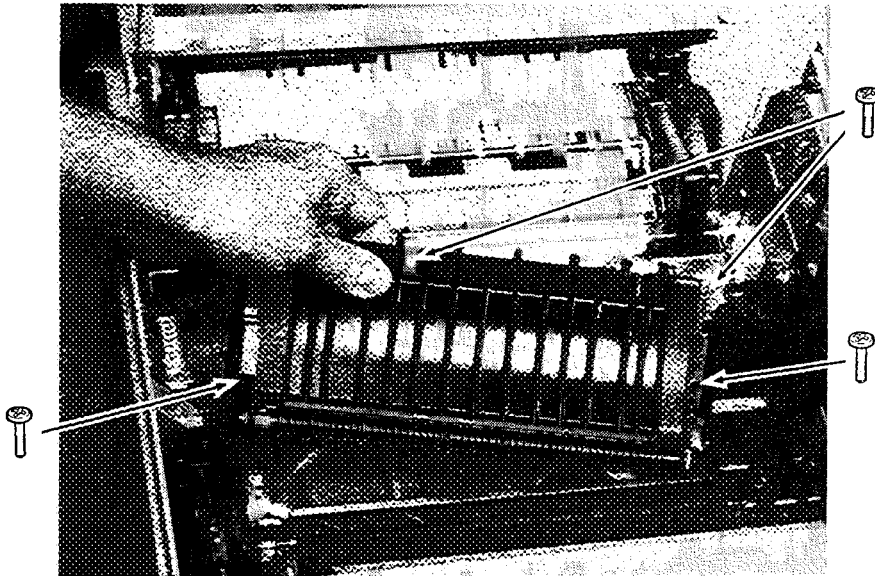

MLO-004641

4.16 Fixing Unit

Use the following procedure to remove and replace the fixing unit of the baseplate of the DEClaser 2100 printer.

1. Open the top cover.
2. Remove the four screws that hold the fixing unit to the baseplate.

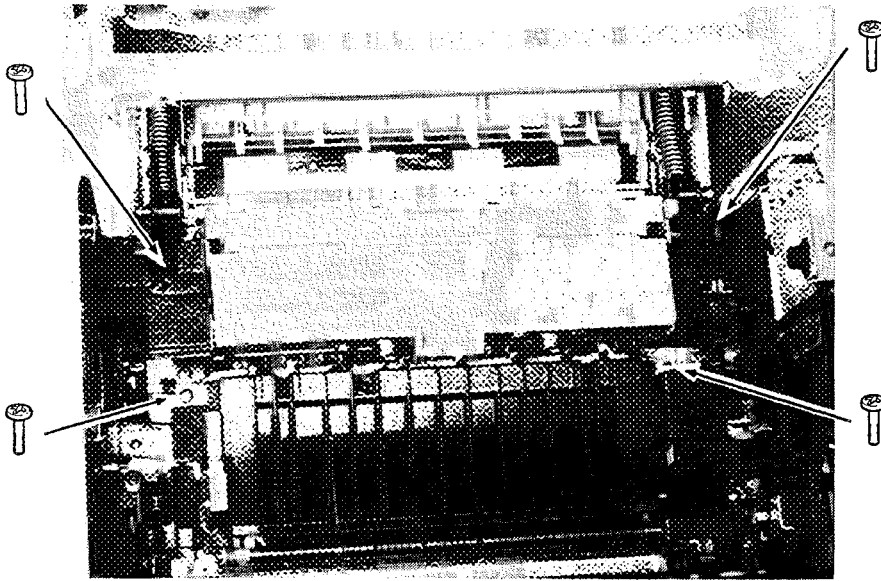

MLO-004642

WARNING: *The fixing unit is hot and can cause minor skin burns. Be careful when you handle or touch the fixing unit.*

3. Lift, unplug, and remove the fixing unit. Place the fixing unit on a work surface.

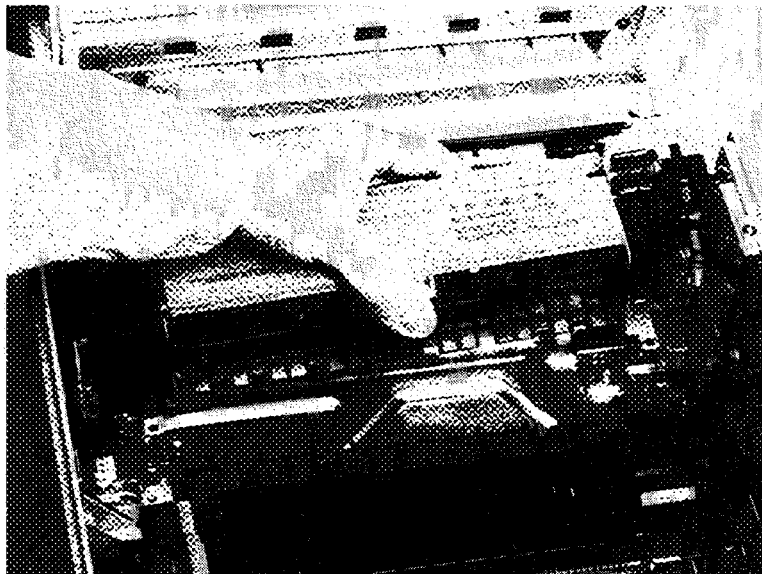

MLO-004643

4. Remove the new spare fixing unit from the special shipping container. Place the new unit next to the defective unit on the work surface.
5. Remove the cleaning pad from the defective fixing unit and install the pad in the new spare replacement.

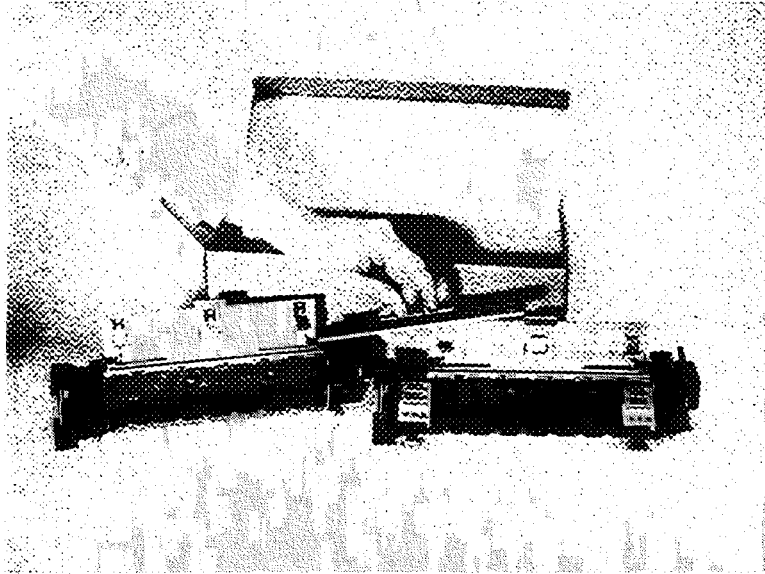

MLO-004644

6. Remove the roller separation wedges from the new spare fixing unit and install them in the old defective fixing unit.
7. Place the defective fixing unit in the special shipping container.

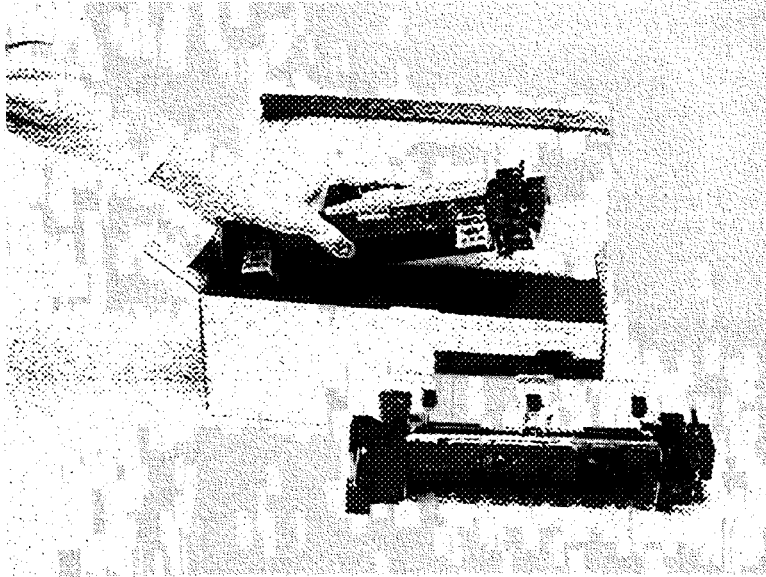

MLO-004645

4.17 Transfer Drive Assembly

The transfer drive assembly consists of the registration rollers, the feed path between the pickup and registration rollers, and the pickup separation pad.

Use the following procedure to remove and replace the transfer drive assembly from the DEClaser 2100 printer.

1. Open the top cover.
2. If installed, remove the cassette.
3. Remove the four screws that hold the transfer drive assembly to the chassis.
4. Remove the guide plate.

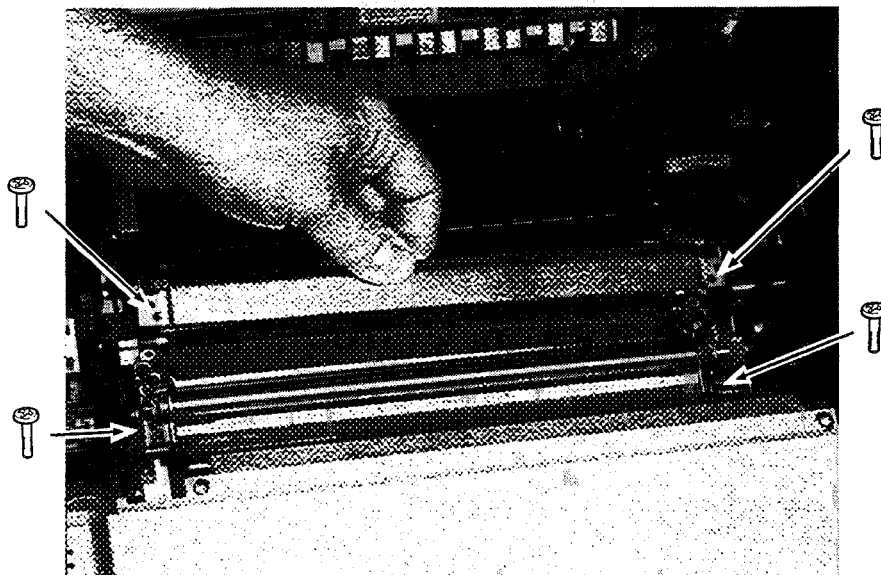

MLO-004646

5. Lift and jog the assembly to carefully disengage the registration clutch and solenoid pawl, and then remove the transfer guide assembly.
6. If the spare transfer assembly has no pickup separation pad, swap the pickup separation pad from the defective unit, as shown in Section 4.17.1.

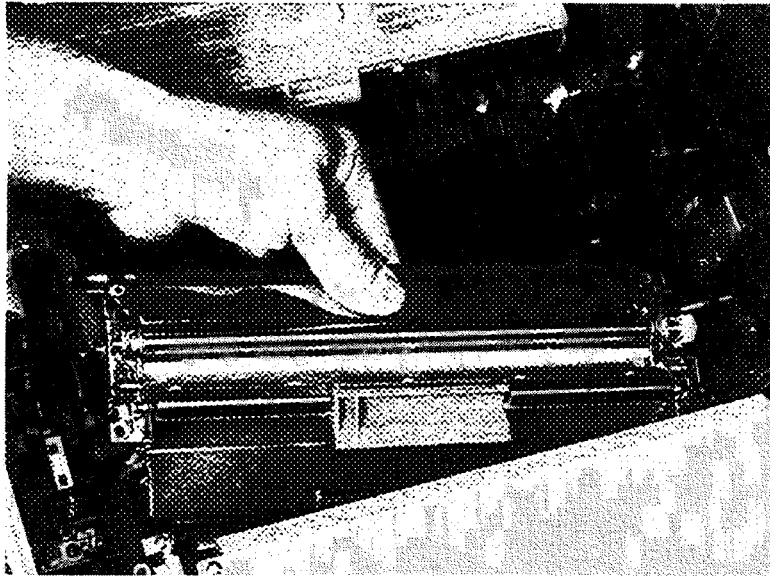

MLD-004647

4.17.1 Separation Pad

Use the following procedure to remove and replace the pickup separation pad that is attached to the transfer assembly of the DEClaser 2100 printer.

1. Remove the transfer drive assembly as shown in Section 4.17. Place the assembly upside down on a work surface.
2. Remove the two screws that hold the spring to the pad posts, and remove the pad assembly.

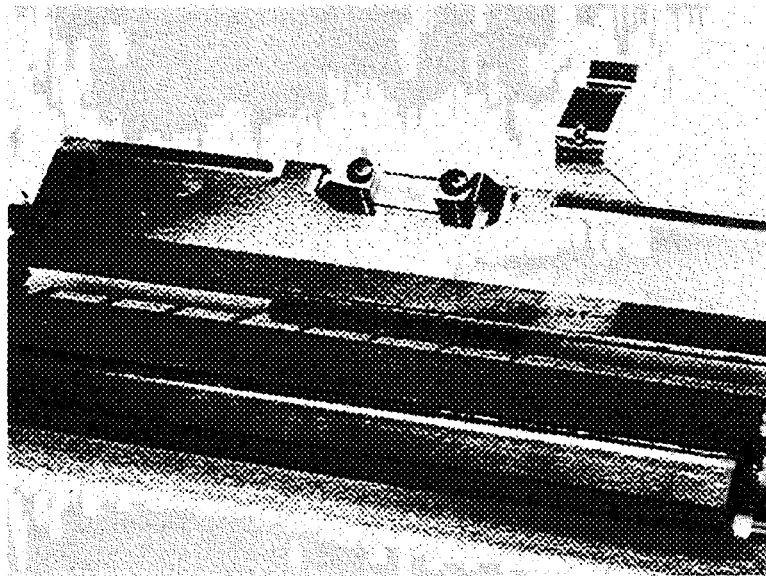

MLO-004648

4.18 Transfer Corona Assembly

Use the following procedure to remove and replace the transfer corona assembly of the DEClaser 2100 printer.

1. Remove the transfer drive assembly as shown in Section 4.17.
2. Remove the HVPSA as shown in Section 4.12.
3. Remove the two screws that hold the transfer corona assembly to the chassis.
4. Remove the transfer corona assembly.

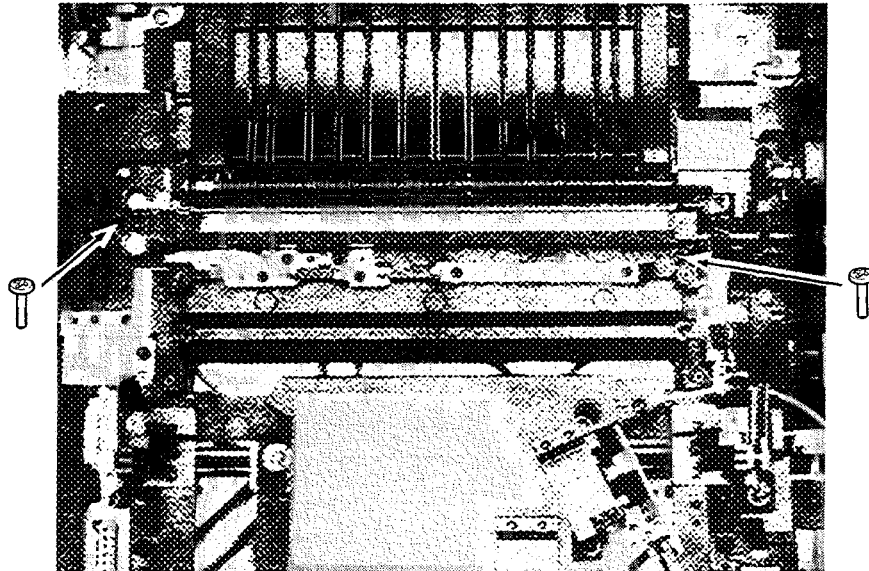

MLO-004649

4.19 Preconditioning Lamp

Use the following procedure to remove and replace the preconditioning lamp assembly of the upper unit of the DEClaser 2100 printer.

1. Open the top cover.
2. Remove the EP-S cartridge as shown in Section 4.6.
3. Remove the screw and the protective flange.

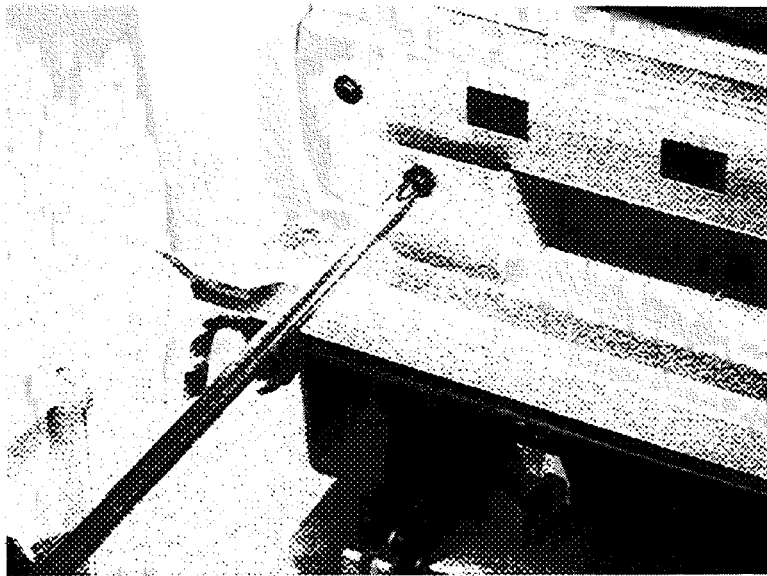

MLO-004650

4. Remove the two screws that connect the power bus.

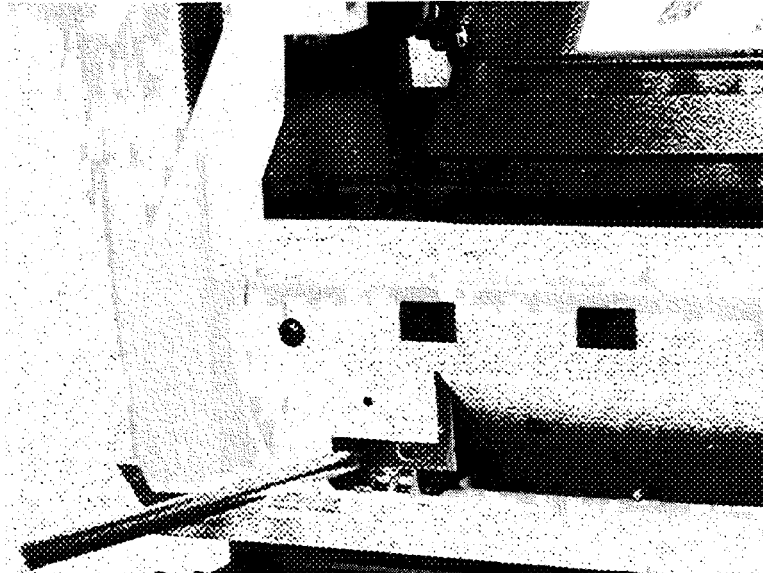

MLO-004651

5. Remove the two screws that hold the lamp assembly to the top cover and remove the lamp assembly.

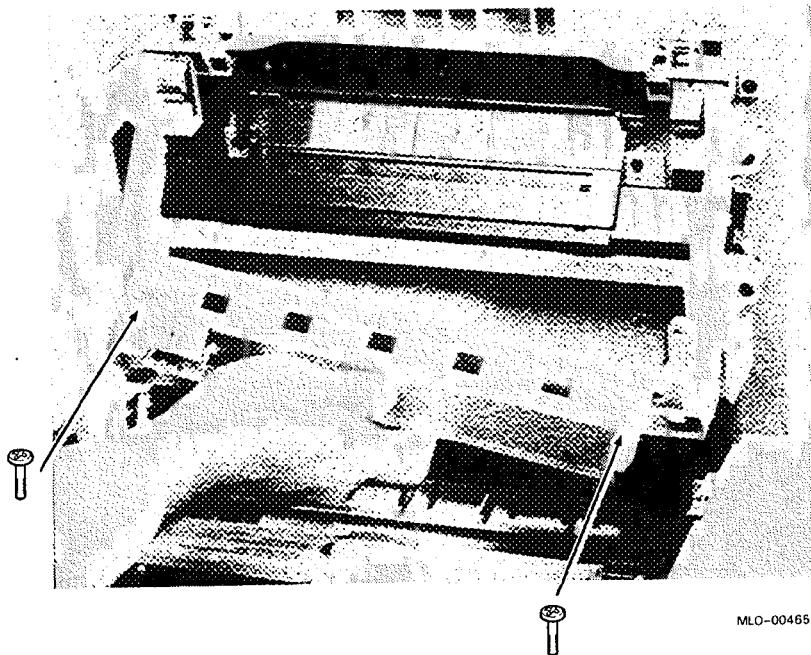

MLO-004652

4.20 Pickup Roller Assembly

Use the following procedure to remove and replace the pickup roller assembly of the DEClaser 2100 printer.

1. Remove the LVPSA as shown in Section 4.13.
2. Remove the screw ❶ that holds the clutch end ❷ of the pickup roller shaft to the chassis ❸.

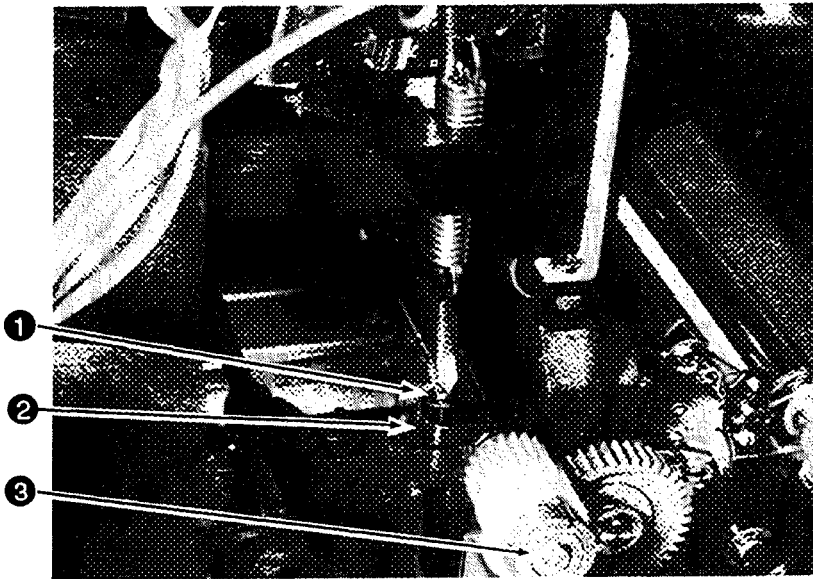

MLO-004653

3. Remove the screw ④ that holds the HVPSA end of the pickup roller shaft to the chassis.

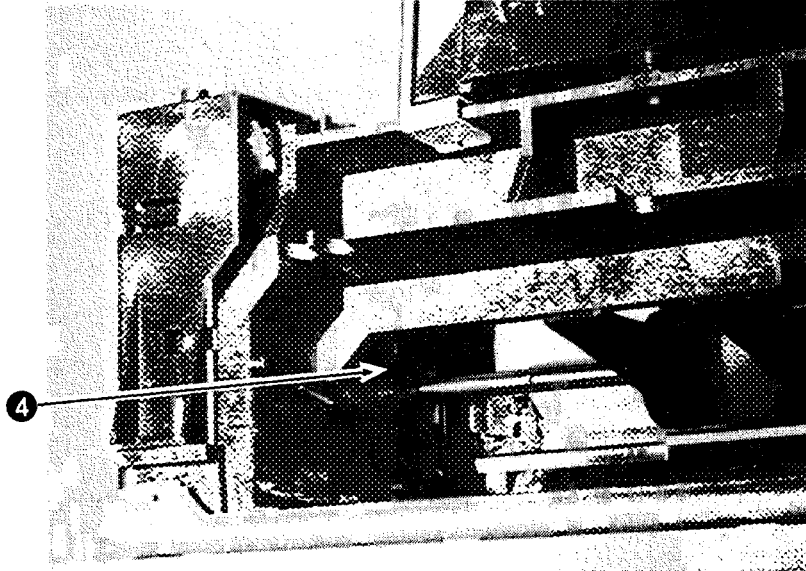

MLO-004654

- Carefully work the pickup roller assembly out of the printer in the direction shown.

CAUTION: *Cuts or contamination from grease can damage the surfaces of the pickup or auxiliary rollers during removal or replacement. Be careful when you handle the pickup roller assembly.*

The pickup roller clutch cannot be replaced in the field. A special tool is used to align the clutch on the pickup roller shaft.

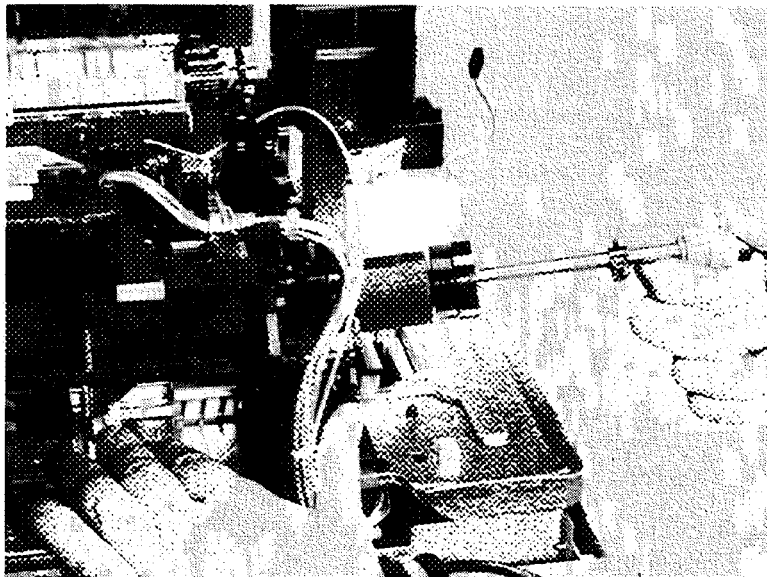

MLO-004655

4.21 Intermediate Gear Assembly

Use the following procedure to remove and replace the intermediate gear assembly of the DEClaser 2100 printer.

1. Remove the following components:
 - a. Upper cover as shown in Section 4.4
 - b. Transfer drive assembly as shown in Section 4.17
 - c. Subpanel and HVPSA as shown in Section 4.12
 - d. Transfer corona assembly as shown in Section 4.18
 - e. LVPSA as shown in Section 4.13
 - f. Fixing unit as shown in Section 4.16
 - g. AC inlet assembly as shown in Section 4.23
 - h. Main motor assembly as shown in Section 4.26
 - i. Pickup roller assembly as shown in Section 4.20
 - j. Inside OPC drum drive gear as shown in Section 4.21.1
2. Remove the three screws that secure the gear train. The center screw **1** is approximately 19 mm (3/4 in.) in length.

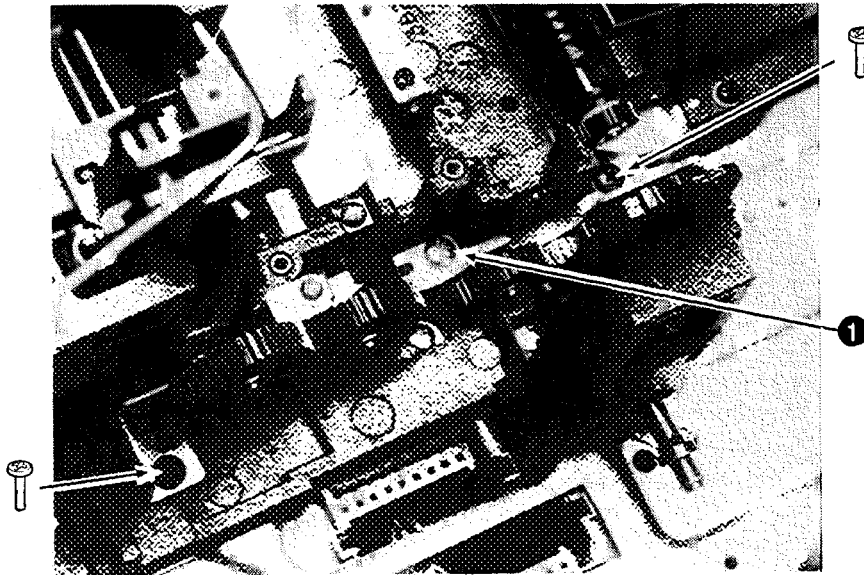

MLO-004656

3. Remove the gear train assembly.

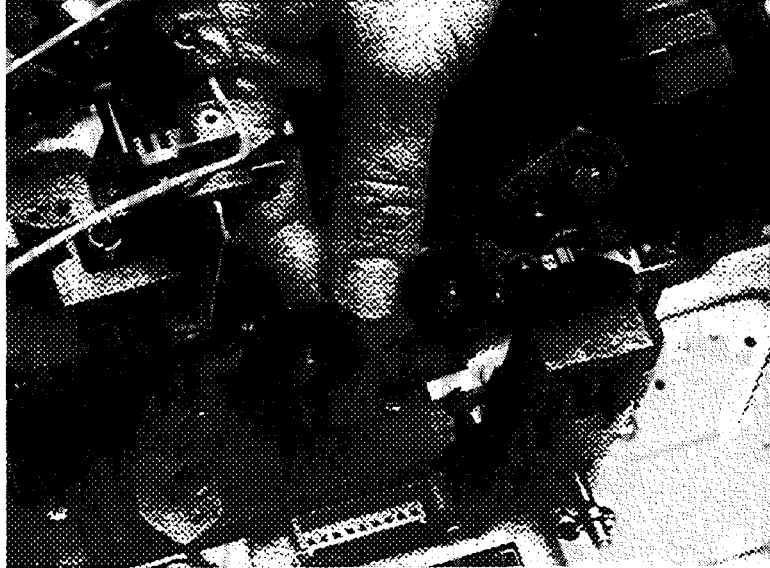

MLO-004657

4.21.1 Inside OPC Drum Drive Gear

Use the following procedure to remove and replace the inside drive gear that is on the end of the OPC drum drive shaft.

1. Remove the following components:
 - a. Upper cover as shown in Section 4.4
 - b. Transfer drive assembly as shown in Section 4.17
 - c. HVPSA as shown in Section 4.12
 - d. Transfer corona assembly as shown in Section 4.18
 - e. LVPSA as shown in Section 4.13
2. Remove the E-ring from the inside of the drive shaft.

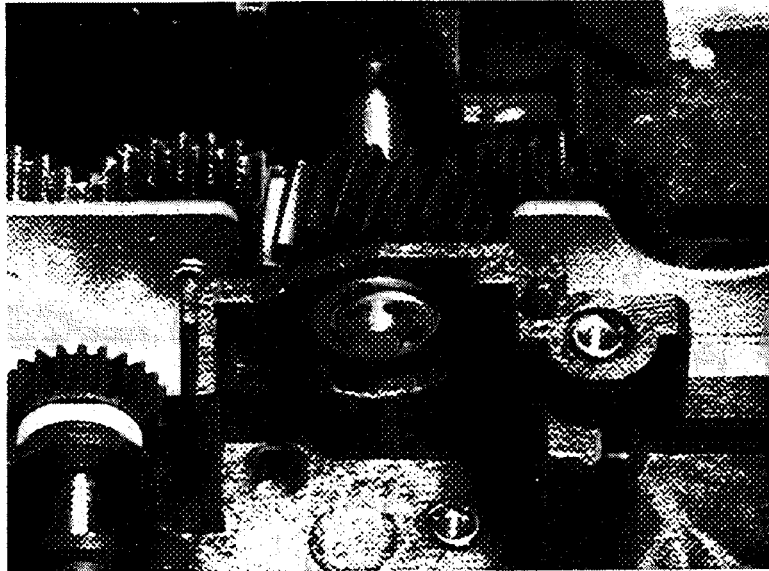

MLO-004658

3. Use a small screwdriver or other suitable tool to push and remove the shaft.
4. Remove the inside OPC drum drive gear.

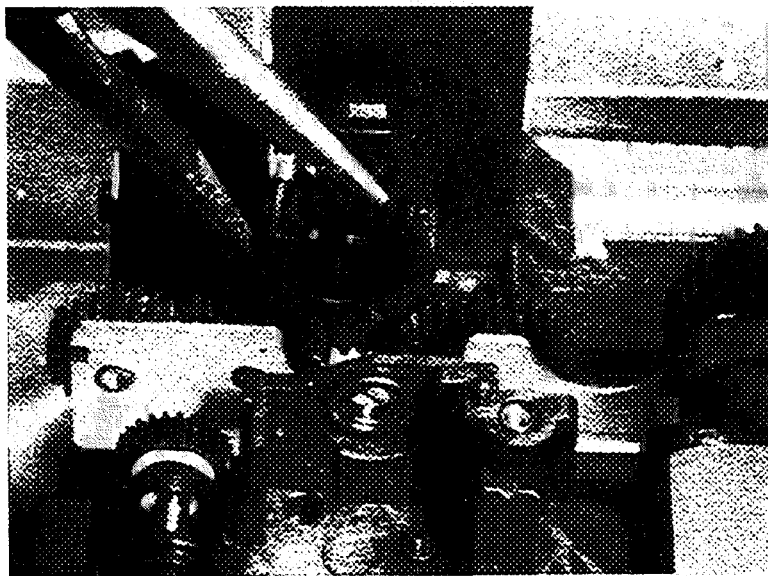

MLO-004659

4.22 Output Roller Assembly

Use the following procedure to remove and replace the output roller assembly of the top cover output tray of the DEClaser 2100 printer.

1. Remove the top cover, as shown in Section 4.2, and place it upside down on a work surface.
2. Remove the two screws from the fixing unit hold-down plate.
3. Remove the fixing unit hold-down plate.

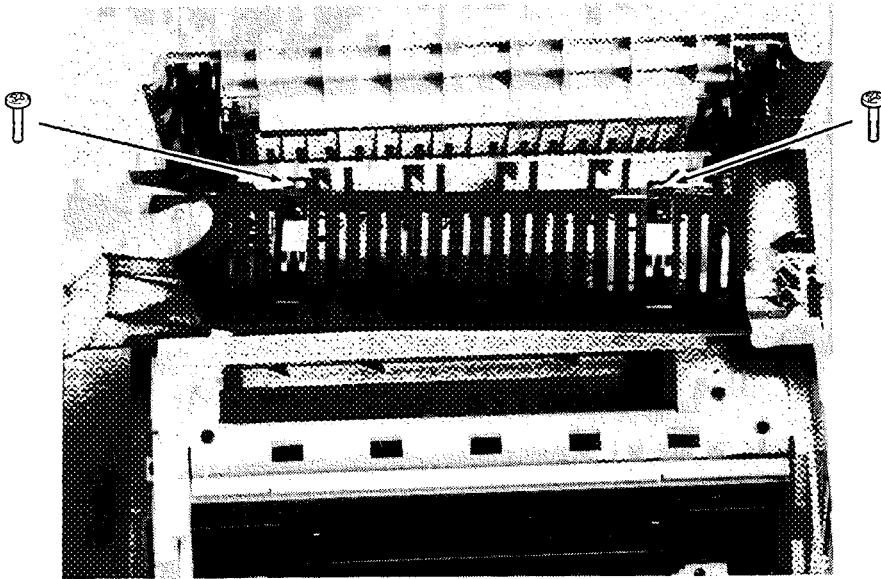

MLO-004660

4. Remove the two plastic threaded screws that hold the tray plate to the top cover.
5. Remove the four screws that hold the assembly to the mounting bulkhead.

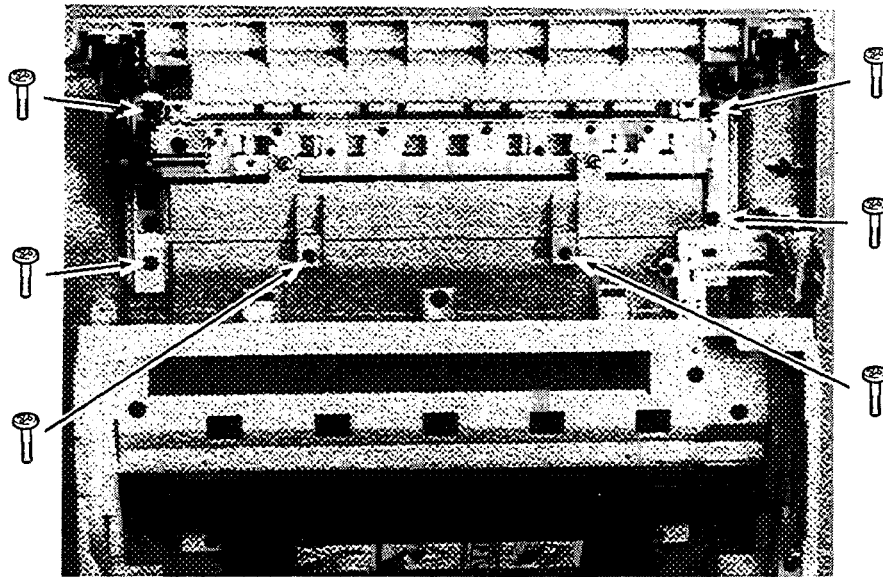

MLO-004661

6. Remove the roller assembly and tray plate. Place the assembly on a work surface.

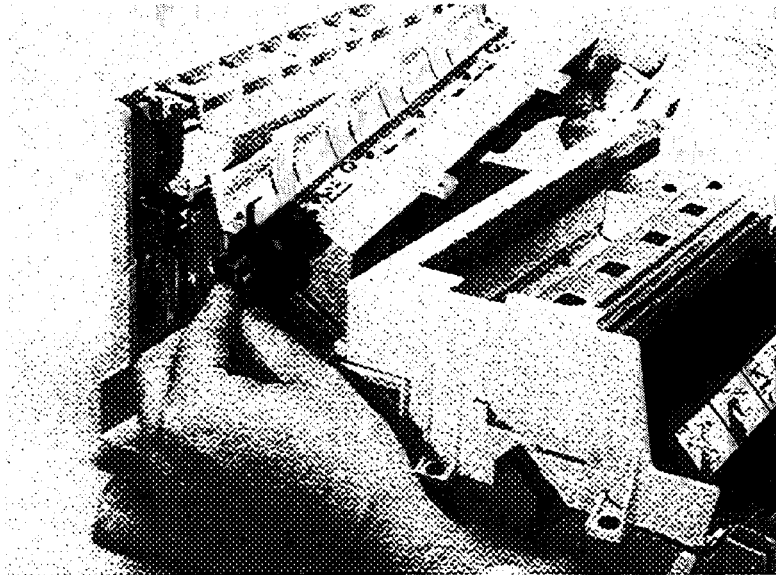

MLO-004662

7. Remove the two shoulder screws and separate the tray plate from the output roller assembly.

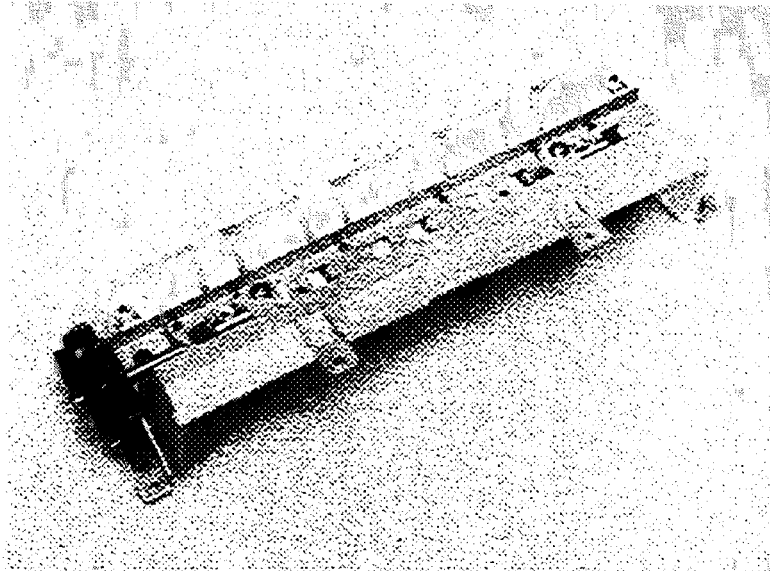

MLO-004663

4.22.1 Output Roller Drive Gears

Use the following procedure to remove and replace the gear assembly that drives the rollers in the top cover output tray.

1. Remove the top cover, as shown in Section 4.2, and place it upside down on a work surface.
2. Remove the screw that holds the assembly to the bulkhead, and remove the assembly.

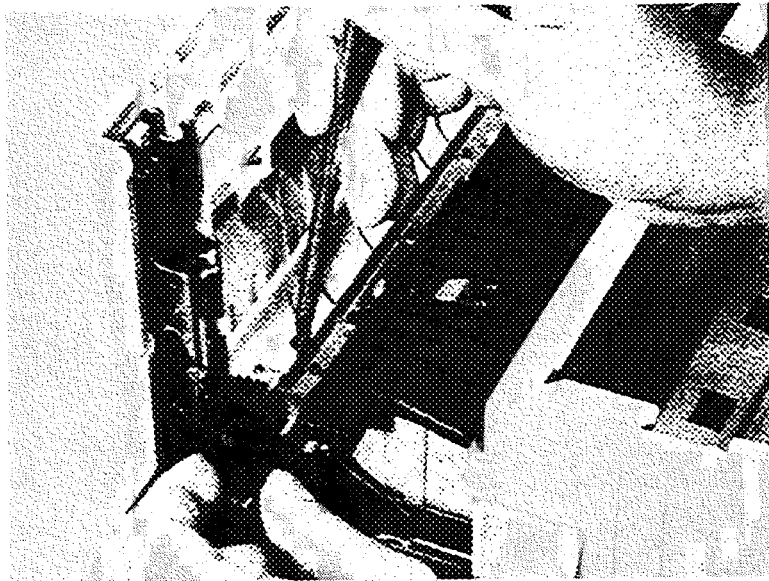

MLO-004664

4.23 AC Inlet Assembly

NOTE: *If you are replacing the ac inlet assembly to fix a 50 SERVICE display fault, be aware that 10 minutes of power-off time are required to clear a 50 SERVICE fault.*

Use the following procedure to remove and replace the ac inlet assembly.

CAUTION: *Use the standard antistatic equipment and procedures when you handle this sensitive electronic component.*

1. Remove the fixing unit as shown in Section 4.16.
2. Remove the upper cover as shown in Section 4.4.
3. Remove the four screws that hold the inlet assembly to the baseplate.
4. Lift, unplug, and remove the ac inlet assembly.

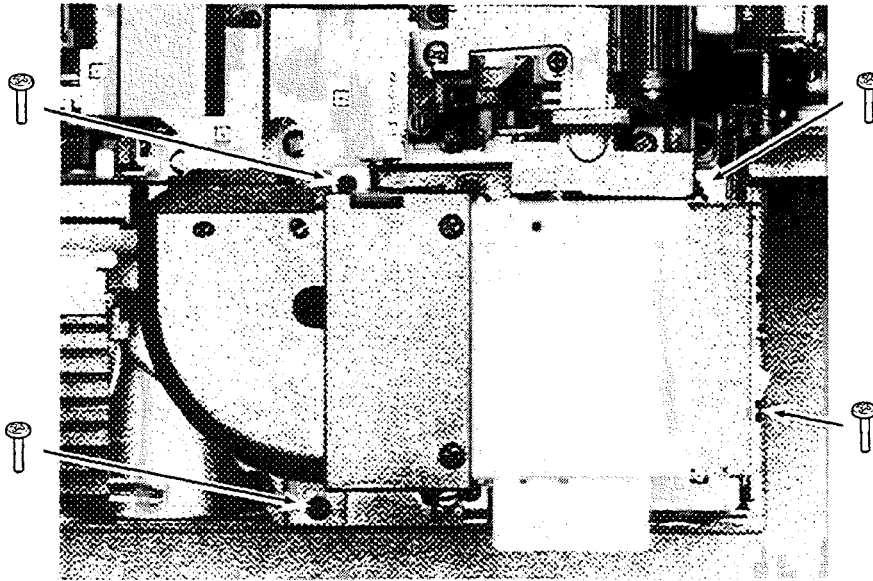

MLO-004665

4.24 Main Fan (FM1)

Use the following procedure to remove and replace the main fan (FM1) of the DEClaser 2100 printer.

1. Remove the two screws that hold the ozone filter housing.
2. Slide the ozone filter housing out of the holding tab and remove the housing.

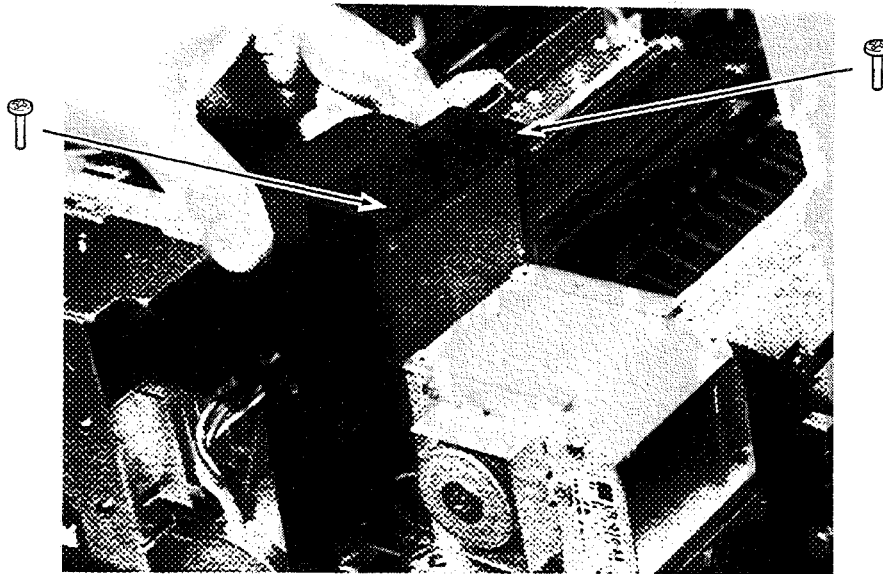

MLO-004666

3. Unplug the connector from the fan control unit ❶.
4. Remove the three screws that hold the main fan to the ac inlet assembly.
5. Remove the main fan.

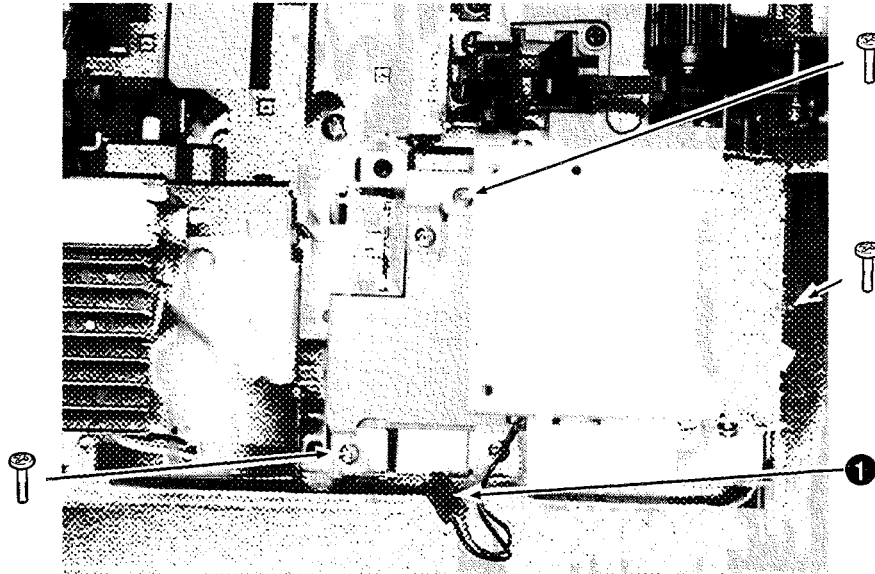

MLO-004667

4.25 Fan (FM2)

Use the following procedure to remove and replace the fan (FM2) of the DEClaser 2100 printer.

1. Remove the bottom cover as shown in Section 4.5.
2. Disconnect the FM2 cable connector from the 2-pin J207 dc control board connector.
3. Remove the four screws that hold the fan and support bracket to the baseplate, and remove the fan.

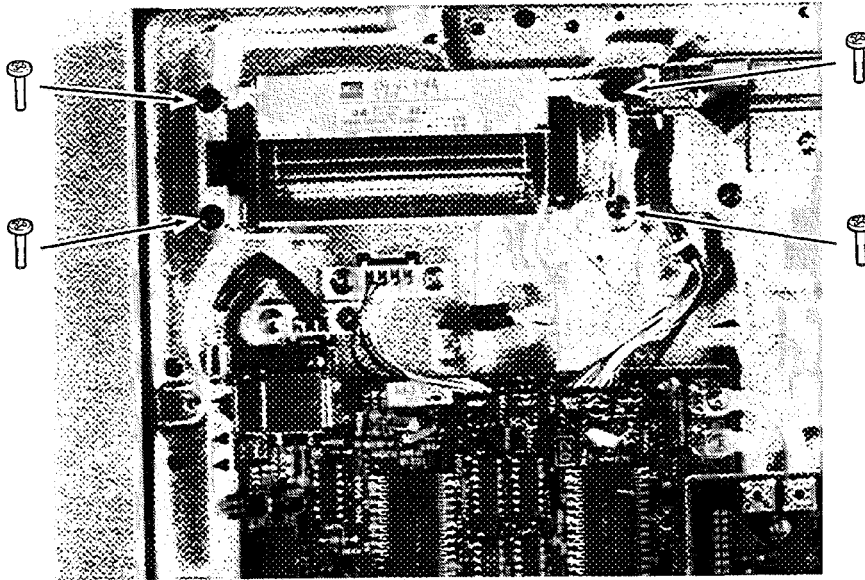

MLO-004668

4.26 Main Motor Assembly

Use the following procedure to remove and replace the main motor assembly of the printer baseplate. The main motor assembly consists of the main motor and main drive gear train.

1. Remove the LVPSA as shown in Section 4.13.
2. Remove the ac inlet assembly as shown in Section 4.23.
3. Remove the five screws that hold the main motor assembly to the baseplate.
4. Remove the main motor assembly.

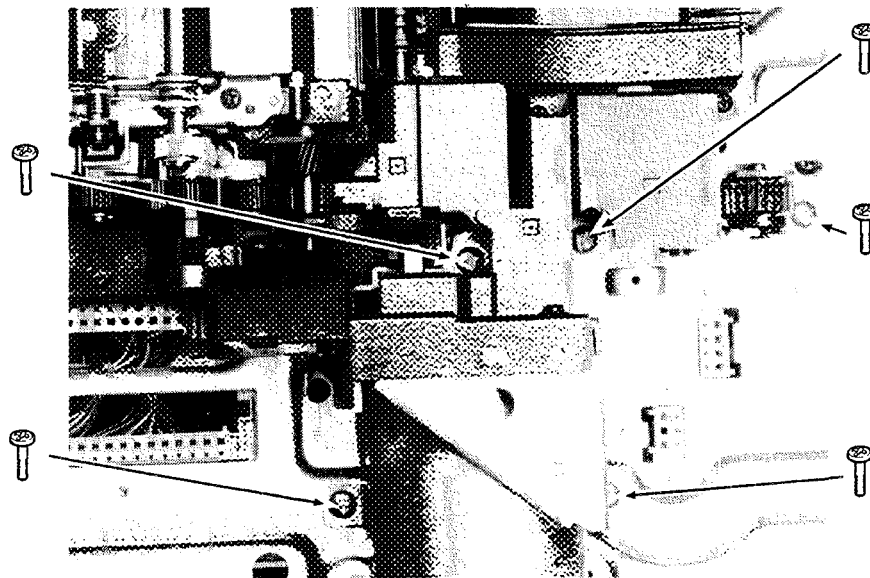

MLO-004669

4.26.1 Main Motor Drive (Gears)

Use the following procedure to remove and replace the main motor drive (gears) of the DEClaser 2100 printer.

1. Remove the main motor assembly as shown in Section 4.26.
2. Remove the four screws that hold the motor flange to the drive assembly.
3. Remove the main motor from the main motor drive assembly.

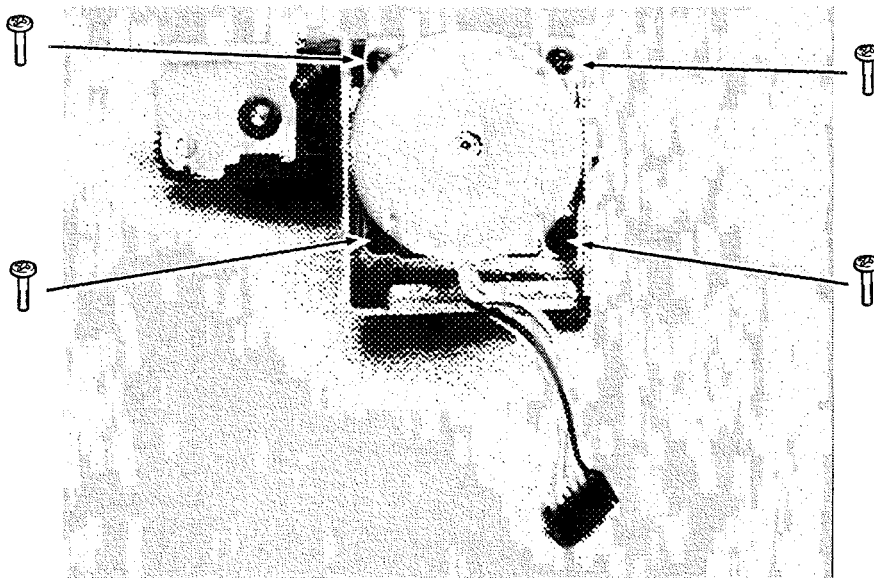

MLO-004670

4.27 Paper Pressure Assembly

Use the following procedure to remove and replace the paper pressure assembly of the DEClaser 2100 printer.

1. Remove the following assemblies and all other parts called for by the following procedures:
 - a. Transfer drive assembly as shown in Section 4.17
 - b. HVPSA as shown in Section 4.12
 - c. LVPSA as shown in Section 4.13
 - d. AC inlet assembly as shown in Section 4.23
 - e. Main motor assembly as shown in Section 4.26
2. Disconnect the three cables from the scanner assembly as shown in Section 4.14.
3. Remove the five screws that hold the motor side of the chassis to the engine baseplate. Note the screw length for reassembly.

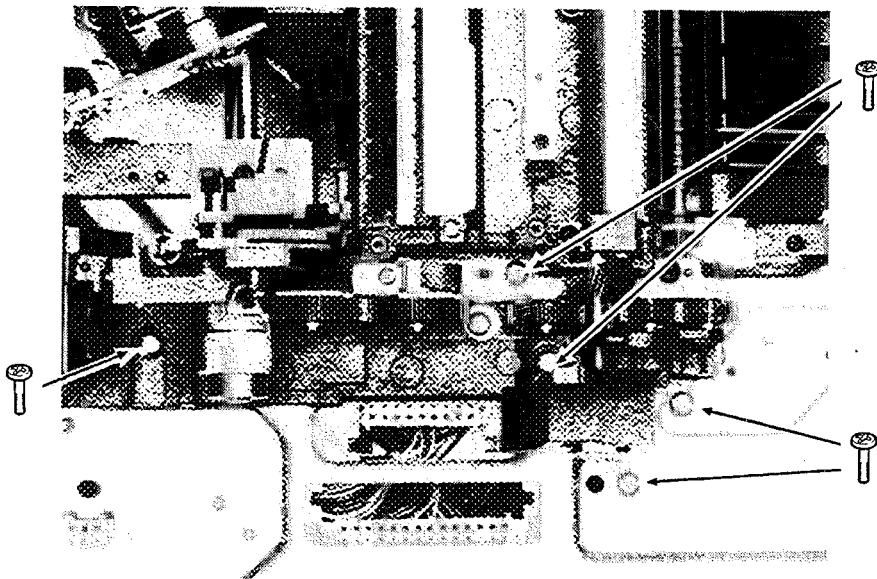

MLO-004671

4. Remove the three screws that hold the cassette end of the chassis to the engine baseplate.

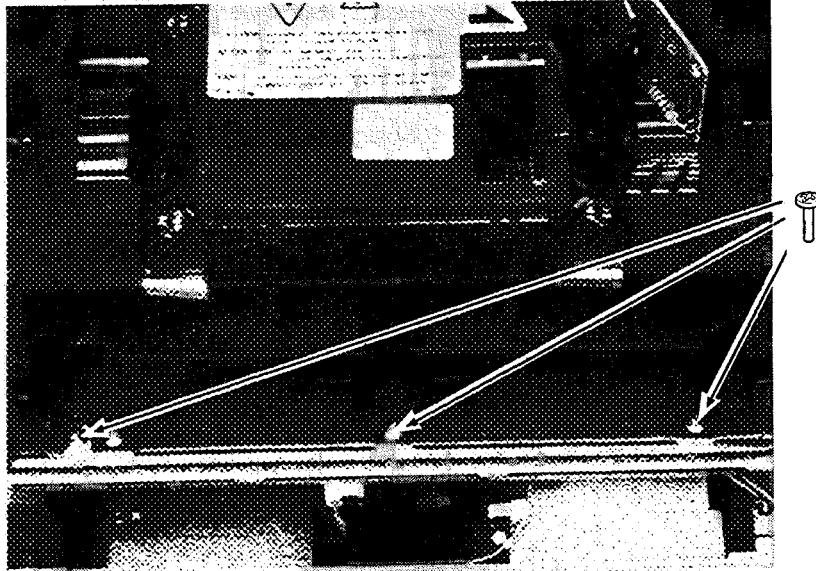

MLO-004672

5. Remove the two screws that hold the HVPSA side of the chassis to the engine baseplate.

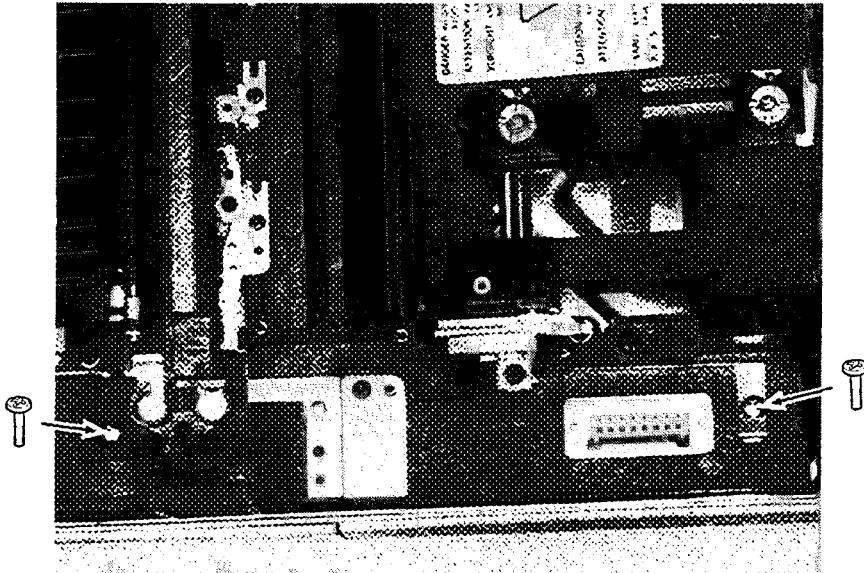

MLO-004673

6. Lift up and remove the chassis assembly from the engine baseplate. Place the chassis assembly end-up on a work surface.

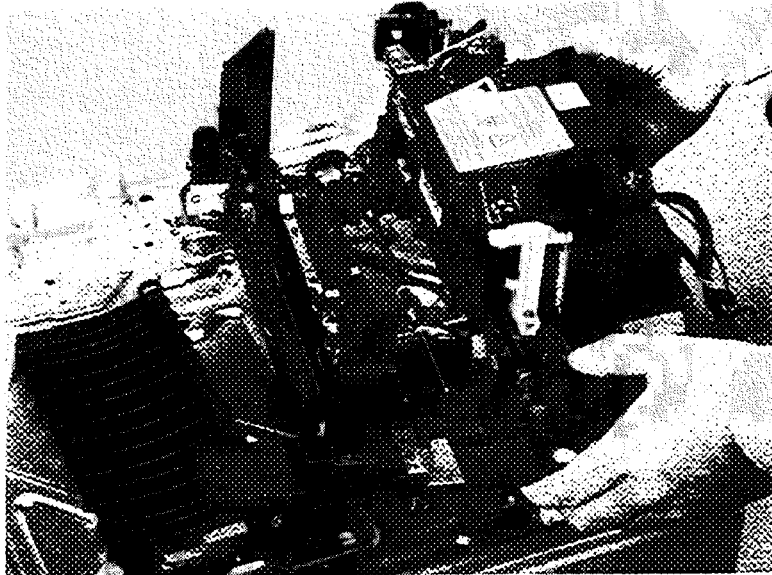

MLO-004674

7. Remove the two screws that hold the paper pressure assembly to the chassis.
8. Remove the paper pressure assembly from the chassis.

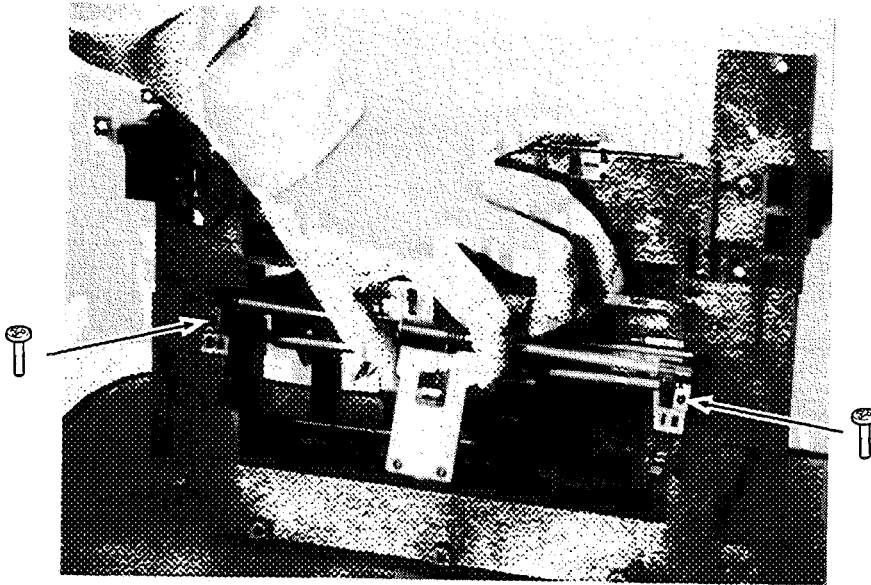

MLO-004675

Appendix A

DECleraser 2100 General Information

This appendix contains general information that you may find useful.

A.1 Macro Numbers

The macro feature (see Table 2-3) is used to set the printer environment to match that of the host system. The macro number is a combination of device identification and character set (Cset). The sum of the two numbers is entered as the macro number.

Device ID	Value
Level 3 device	00
LN03	10

Table A-1 describes the available character sets and gives their values.

Consult the *Digital ANSI-Compliant Printing Protocol Level 3 Programming Reference Manual* for more information about the various User Preference sets.

Table A-1: User Preference Character Sets

User Preference Set	Value
DEC Supplemental	0
ISO Latin-1	1
JIS Katakana	2
DEC 7-Bit Hebrew	3
ISO Latin-Hebrew Supplemental	4
DEC Hebrew Supplemental	5
DEC Technical	6

A.2 Interface Interconnections

The DEClaser 2100 printer can connect to a host system through the 8-bit parallel bus or through the serial port. You select a port through the I/F (interface) display.

A.2.1 Parallel Port

The parallel port uses a Centronics interface protocol and a 36-pin connector. Table A-2 gives the pin numbers and signal names.

Table A-2: Parallel Interface Pin Assignment

Pin Number	Signal	Direction
1	$\overline{DataStrobe}$	In
2	Data 1	In
3	Data 2	In
4	Data 3	In
5	Data 4	In
6	Data 5	In
7	Data 6	In
8	Data 7	In
9	Data 8	In
10	\overline{ACK}	Out
11	Busy	Out
12	Call (PE)	Out
13	Select	Out
14-15	Not connected	-
16	Logic ground	-
17	Chassis ground	-
18	5 volts	Out
19-29	Ground	-
30	$\overline{InputPrimeRet}$	Out
31	$\overline{InputPrime}$	In

Table A-2 (Cont.): Parallel Interface Pin Assignment

Pin Number	Signal	Direction
32	\overline{Fault}	Out
33	Aux out 1 ¹	-
34	Not connected	-
35	Aux out 2 ¹	-
36	Not connected	-

¹Ignored

A.2.2 Serial Port

The serial port is RS232C compatible and connects through a 25-pin connector. Table A-3 lists the pin numbers, signal names and direction, and the wiring connections inside a null modem cable. Pin numbers that are not mentioned are not used.

Table A-3: Serial Interface

Printer Pin	Signal Name	Signal Direction	Host Pin Null Modem
1	Frame Ground (FG)	Not directional	Not applicable
2	Transmit Data (TD)	To host system	Pin 3
3	Receive Data (RD)	From host system	Pin 2
4	Request To Send (RTS)	To host system	5
6	Data Set Ready (DSR)	From host system	20
7	Signal Ground (SG)	Not directional	Not applicable
20	Data Terminal Ready (DTR)	To host system	6

A.3 Interface Cables and Adapters

Table A-4 lists the adapters you need to connect the various host systems to the DEClaser 2100 printer.

NOTE: For a complete list of accessories and supplies and instructions on how to order them, refer to the DEClaser 2100 Printer Operator's Guide.

Table A-4: Cables and Adapters

Connector and System Type	System, Cable, and Printer Adapters
25-Pin Plug Connector	
VAXstation 3200/3500	H8571-A (25-pin-to-MMJ)
VT100 Series	BC16E ¹
DECserver 200/MC (DSRVB-AA)	H8571-E ¹
CPU RS232 Ports	
9-Pin Plug Devices (DEC)	
VT200 Series	H8571-B (9-pin-to-MMJ)
DECmate	BC16E ¹
PRO Series	H8571-E ¹
VAXstation 2000	
DEC423 (MMJ) Serial Devices	
VAXmate	BC16E ¹
MicroVAX 2000	H8571-E ¹
DECserver 300	
DECserver 200/DL (DSRVB-BA)	
VT300 Series	
CPU DEC423 Ports	
25-Pin Socket Devices	
Rainbow	H8571-D
Digital Modems	BC16E ¹
	H8571-E ¹
9-Pin Plug Devices (IBM PC/AT Type)	
DECstation 210, 212	H8571-J
DECstation 316, 320	BC16E ¹
IBM PC/AT	H8571-E ¹
	Use Data Terminal Ready (DTR) flow control. Refer to the <i>DECclaser 2100 Printer Operator's Guide</i> .

¹H8571-E and BC16E (DECconnect cable) are included with the DECclaser 2100 printer.

Table A-4 (Cont.): Cables and Adapters

Connector and System Type	System, Cable, and Printer Adapters
European DECstation Serial Port	
200 Series	12-27591-01 extender cable. H8571-A BC16E ¹ H8571-E ¹
300, 350 Series	H8571-A BC16E ¹ H8571-E ¹
European DECstation Parallel Port	
200, 300, 350 Series	BC19M-10
Existing Cable	
BC22D cable (already installed)	H8571-C BC16E ¹ H8571-E ¹ The combination of the H8571-C adapter, the BC16E cable, and the H8571-E acts as a straight-through cable.
¹ H8571-E and BC16E (DECconnect cable) are included with the DECclaser 2100 printer.	

Appendix B

DEClaser 2100 Specifications

This appendix gives general specifications for the media and operation of the DEClaser 2100 printer.

B.1 Print Media

The types of print media described in this section are paper, labels, transparencies, and envelopes. For additional information about print media, consult the *Digital Laser Printers Guide to Paper and Other Media*, available from DECdirect.

B.1.1 Paper Handling and Storage

Even if the customer is using paper that meets all specifications, improper handling and storage can alter paper quality and printer performance. Paper jams, misfeeding, and image defects are directly traceable to the mishandling and improper storage of paper.

Paper Handling

Be aware of the following considerations when handling paper:

- Load the cassette to its proper capacity rather than adding small amounts at a time.
- When you unwrap a new package of paper, discard the top and bottom sheets, as they tend to absorb the most humidity from the surrounding environment.
- Load the paper in the cassette with the top side up. On most paper packages, an arrow indicates the top side of the paper.

Paper Storage

Be aware of the following considerations when storing paper:

- Do not unwrap paper until you are **READY** to load it into the cassette. The wrapping paper protects the paper against humidity.
- Do not store paper directly on the floor because floors are generally very damp.
- Lay paper on a flat surface to prevent in-ream paper curl.

B.1.2 Acceptable Paper

Table B-1 lists cassettes that are available for use in the DEClaser 2100 printer.

Table B-1: Available Cassettes

Paper Size	Dimensions
A4	8.27 in. x 11.69 in. (210 mm x 297 mm)
Executive	7.25 in. x 10.5 in. (184.1 mm x 266.7 mm)
Letter	8.5 in. x 11.0 in. (215.9 mm x 279.4 mm)
Legal	8.5 in. x 14.0 in. (215.9 mm x 355.6 mm)
Envelopes	Envelope size is variable. See Section B.1.3.

Manual Feed Paper Sizes

Manual feed operation can accept all of the paper sizes listed in Table B-1 as well as variable paper sizes from 100 mm x 190 mm (3.9 in. x 7.5 in.) to 216 mm x 356 mm (8.5 in. x 14.0 in.).

Table B-2 lists the paper specifications for the DEClaser 2100 printer.

Table B-2: Paper Specifications

Category	Specification
Paper Weight: Cassette Feed	60 g/m ² to 80 g/m ² basis weight (16 lb to 21 lb)
Paper Weight: Manual Feed	84 g/m ² to 135 g/m ² basis weight (22 lb to 35 lb)
Thickness	0.075 mm to 0.115 mm
Moisture Content	5% to 8%
Smoothness	20 to 45 seconds (both Felt and Wire sides) IF-WI > 5 seconds
Brightness	84% minimum
Heat Tolerance	200°C (392°F) for 0.1 second
Stiffness	50-80 cm ² /100 (vertical) 20-40 cm ² /100 (horizontal)
Electrical Resistance	1.0 x 10 ¹¹ -2.0 x 10 ¹² ohm-cm (cubic content) 2.0 x 10 ¹⁰ -2.0 x 10 ¹¹ ohm-cm (surface)
Cotton (Rag) Content	25% maximum

Special Considerations When Printing on Paper

Use caution when you print on the following types of papers.

- The ink from some printed papers, such as those with a company letterhead, can cause smearing and in some extreme cases can damage the fixing unit heat roller.
- Some colored papers use an applied coating of ink or other coloring agent. The coating can come off and contaminate the fixing unit rollers.
- Do not use thermal papers.
- Do not use carbon papers.

CAUTION: *Print test samples of the paper before you use it for the first time. This is particularly important when using chemically treated or coated paper, such as printed forms or colored paper. The inks and pigments used on these papers must also be able to withstand the high heat and pressure of the fixing unit. Consider also the heat limitations of transparencies and of the glues used on envelopes and labels.*

B.1.3 Envelopes

Envelopes must meet the same specifications as the paper listed in Table B-2.

Do not use the following types of envelopes with the printer:

- Envelopes with sealing flaps that are open
- Envelopes with sealing flaps at the leading or trailing edges
- Envelopes with three or more layers of paper at the leading and trailing edges
- Envelopes that have transparent windows
- Envelopes that have clasps, snaps, or strings

Special Considerations When Printing on Envelopes

Observe the following considerations when printing on envelopes:

- Feed envelopes manually or use the envelope cassette.
- Print only the front side of an envelope.
- You cannot print in the 15 mm (0.6 in.) border.

B.1.4 Transparencies

Table B-3 contains information on the sizes of transparencies that can be used in the DEClaser 2100 printer.

Table B-3: Transparency Sizes

Transparency Size	Dimensions
A4	210 mm x 297 mm (8.26 in. x 11.69 in.)
Letter	215 mm x 279.4 mm (8.5 in x 11.0 in)

Table B-4 lists the specifications of transparencies that can be used with the DEClaser 2100 printer.

Table B-4: Transparency Specifications

Category	Specification
Transparency weight	60 g/m ² to 135 g/m ² basis weight (16 lb to 36 lb)
Thickness	0.075 mm to 0.115 mm
Moisture content	5% to 8%
Smoothness	20 to 45 seconds (both Felt and Wire sides) IF-WI 5 seconds
Brightness	84% minimum
Heat tolerance	200°C (392°F) for 0.1 second
Stiffness	50–80 cm ² /100 (vertical) 20–40 cm ² /100 (horizontal)
Electrical resistance	1.0 x 10 ¹¹ –2.0 x 10 ¹² ohm-cm (cubic content) 2.0 x 10 ¹⁰ –2.0 x 10 ¹¹ ohm-cm (surface)

Special Considerations When Printing Transparencies

Please be aware of the following considerations when printing on transparencies.

- Feed transparencies manually.
- Remove transparencies from the rear output tray as each one is printed to prevent them from sticking to each other.
- Do not use transparencies that have a paper backing.

B.2 Labels

A label consists of a face sheet, an adhesive sheet, and a carrier sheet. The face sheet (or printing surface) is usually composed of photocopying paper and should meet the same specifications for paper as described in Table B-1. The carrier sheet and adhesive used for the labels must also be able to meet the heat tolerance specification of 200°C (392°F) for at least 0.1 second.

Do not expose the adhesive on the labels. Doing so could cause damage to the printer. An easy way to test for adhesive that may be exposed is to press a plain piece of paper on top of the sheet of labels. If the paper does not stick to the labels, then they are acceptable to use.

Special Considerations When Printing on Labels

Observe the following considerations when printing on labels:

- Feed labels manually.
- Be sure that the carrier sheet is not exposed.
- Be sure that no adhesive is exposed.

B.3 Operating Specifications

This section contains the operating and interface specifications for the DEClaser 2100 printer.

Type:	Desktop page printer
Printing Method:	Electrophotographic, using laser beam scanning
Laser Power:	5 mW maximum
Resolution:	300 dpi
Printing Speed:	8 pages/minute maximum, using A4 or letter-size paper from the cassette
Warm-Up Time:	Less than one minute at 20°C (68°F)
Paper Cassette:	200-sheet capacity Letter (8 ½ in. x 11 in.) A4 (297 mm x 182 mm) Executive (7 ¼ x 10 ½ in.) Legal (8 ½ in. x 14 in.)
Manual Feed:	One sheet at a time 100 mm x 190 mm (3.9 in. x 7 ½ in.) to 216 mm x 356 mm (8 ½ in. x 14 in.)
Top Output Tray Capacity:	100 sheets (facedown stacking)
Rear Output Tray Capacity:	20 sheets (faceup stacking)
Paper Weight Range Cassette Feed:	60 g/m ² to 80 g/m ² basis weight (16 lb to 21 lb)
Paper Weight Range Manual Feed:	60 g/m ² to 135 g/m ² basis weight (16 lb to 35 lb)

Built-in Font Files:

The DEClaser 2100 has 36 built-in font files. The font files consist of four fonts and nine character sets. These fonts are:

- Courier 10-point normal¹ portrait
- Courier 10.3-point normal portrait
- Courier 6.7-point normal landscape
- Elite 12-point normal portrait

For each font the following character sets reside in the printer:

- ASCII
- DEC Supplemental
- ISO Latin-1 Supplemental
- DEC Technical
- DEC Special Graphics (VT100 Line Drawing)
- DEC 7-Bit Hebrew
- DEC Hebrew Supplemental
- ISO Latin-Hebrew Supplemental
- Legal

Font Cartridges:

Capacity for two optional font cartridges

Built-in RAM:

0.5 MB, expandable to 3.5 MB
with optional RAM boards

Host Interface:

Parallel (Centronics) and serial (RS232C)

Acoustic Noise:

40 dB(A) maximum during standby
53 dB(A) maximum during printing

Operating Temperature:

10°C to 32.5°C (50°F to 90.5°F)

Operating Humidity:

20% to 80% relative humidity

Storage Temperature:

0°C to 35°C (32°F to 95°F)

Storage Humidity:

10% to 80% relative humidity

Power Requirements:

100–115 Vac, 50/60 Hz
220–240 Vac, 50 Hz

¹Normal means that the font is not set in bold or italics or otherwise attributed.

Power Consumption:

100–115 Vac models = 810 W @ 115 Vac
220–240 Vac models = 790 W @ 240 Vac

Packaged Weight:

Approximately 24.0 kg (54 lb)

Installed Weight:

Approximately 20.6 kg (45.5 lb)

Dimensions:

Width: 454 mm (17.9 in.)
Depth: 525 mm (20.7 in.)
Depth: 815 mm (32.1 in.) with A4 paper cassette
installed and the rear output tray opened
Height: 228 mm (9.0 in.)

Appendix C

DEClaser 2100 Total Call Concept (TCC)

C.1 Performing TCC

The total care concept (TCC) procedure is performed whenever the Customer Services engineer (CSE) is called to repair or service the printer. Always repair the printer first and then perform the TCC procedure.

C.2 Maintenance Log

You must keep an accurate maintenance history to ensure the long life and reliability of the DEClaser 2100 printer. When you first arrive at the site, review the maintenance log for information that can assist you to troubleshoot and repair the malfunctioning printer. After you fix the problem, record your activity in the maintenance log for the benefit of the next service person.

Copies of the maintenance log are included in the pocket of the binder of this service guide. It is recommended that you photocopy a plentiful supply of the maintenance log and carry several copies.

A special adhesive-backed pouch is available for storing the maintenance log at the customer's site. The order number for the pouch is 36-18307-04. Attach the pouch to the bottom cover underneath the printer.

Page Count Record

The recorded page count information is used for contractual purposes such as excess usage and refurbishment charges, and for service purposes such as TCC and the 100K preventive maintenance (PM). All page count information is recorded in the page count integrated circuit (IC) that is installed on the video control board. If you replace the video control board, remove the page count IC from the defective board and install it on the new video control board, as shown in Section 4.8.1.

Use the following procedure to obtain the current page count number and to determine if you need to perform the 100K preventive maintenance (PM) procedure.

1. Press **Test/Font** to obtain a copy of Test Print A and the current page count. Figure 2-5 shows an example of Test Print A.
2. Obtain page count information from the maintenance log.
3. You must perform the 100K PM if the page count number is close to or exceeds 100,000 pages, or if 100,000 pages have been counted since the last 100K PM.

C.3 100K PM Procedure

After every 100,000 pages, replace the following FRUs. Refer to Table 4-1 for part numbers.

- Fixing unit
- Separation pad
- Pickup roller assembly
- Transfer corona assembly
- Ozone filter

C.4 TCC Procedure

When you perform the TCC procedure, you will enhance the reliability of the printer and reduce the number of service calls that are required to support the printer.

Use the historical information from the maintenance log to analyze the reliability of the printer and of a component within the printer. If you are uncertain that a component is worn, broken, or contaminated but suspect that it is, replace it anyway. This should reduce the number of service calls over the lifetime of the printer.

CAUTION: *Always use the special vacuum cleaner mentioned in the Tools section of the Preface of this book for cleaning up toner. The toner powder can pass through the bag or filter of a conventional vacuum cleaner and cause damage.*

Damaged, worn, or broken printer components cause intermittent problems and accelerate the aging of mechanical components. Pinched or frayed wires can randomly short circuit. Paper dust, dirt, and toner on rollers, bearings, and gears cause premature failures. Replace any rollers that have flat spots, surface glazing or cracking, or dust and toner contamination.

C.4.1 External Cleaning

Clean and vacuum toner, paper dust, and dirt from the following areas of the DEClaser 2100 printer:

- The cassette and cassette top
- The pickup roller assembly and paper paths
- Registration rollers and paper paths
- Area around the transfer and separation charger
- EP-S cartridge assembly
- Paper feed guide assembly
- Fixing unit entrance and exit areas
- Output rollers and paper paths
- Facedown and faceup stacking trays

C.4.2 Internal Cleaning and Inspection

Clean, vacuum, and inspect the following areas beneath the covers of the DEClaser 2100 printer:

1. Remove the upper cover of the printer.
2. Inspect and clean the inside of the printer and look for toner spills, paper dust, or foreign objects.
3. Inspect the surface condition of the pickup roller and separation pad. Do not contaminate the surface of the roller or pad with grease from your fingers.
4. Use the special cleaning tool provided with each printer to clean the primary and transfer charge wires. You can also use a dry cotton swab. Vacuum the well that the charge wire resides in. The special cleaning tool is shown in Figure 1-3.
5. Inspect the rollers of the fixing unit for scratches or damage.
6. Press **Test/Font** to print several copies of Test Print B while you are filling out service call paperwork. This ensures the customer that the printer is functioning and in good operating order.
7. Replace the upper cover.