

VNswitch 900EE

Installation and Configuration

Part Number: EK-DVNEE-IN .B01

February 1997

This manual describes how to install and configure the VNswitch 900EE.

Revision/Update Information: This is a revised document.

Digital Equipment Corporation makes no representations that the use of its products in the manner described in this publication will not infringe on existing or future patent rights, nor do the descriptions contained in this publication imply the granting of licenses to make, use, or sell equipment or software in accordance with the description.

Possession, use, or copying of the software described in this publication is authorized only pursuant to a valid written license from Digital or an authorized sublicensor.

© Digital Equipment Corporation 1997. All rights reserved. Printed in U.S.A

The following are trademarks of Digital Equipment Corporation: clearVISN, the clearVISN logo, DEC, DEChub, Digital, the DIGITAL logo, and ThinWire.

All other trademarks and registered trademarks are the property of their respective holders.

FCC Notice — Class A Computing Device:

This equipment generates, uses, and may emit radio frequency energy. The equipment has been type tested and found to comply with the limits for a Class A digital device pursuant to Part 15 of FCC rules, which are designed to provide reasonable protection against such radio frequency interference.

Operation of this equipment in a residential area may cause interference in which case the user at his own expense will be required to take whatever measures may be required to correct the interference. Any modifications to this device - unless expressly approved by the manufacturer - can void the user's authority to operate this equipment under part 15 of the FCC rules.

VCCI Notice — Class 1 Computing Device:

This equipment is in the 1st Class category (information equipment to be used in commercial and/or industrial areas) and conforms to the standards set by the Voluntary Control Council for Interference by Data Processing Equipment and Electronic Office Machines aimed at preventing radio interference in commercial and/or industrial areas. Consequently, when used in a residential area or in an adjacent area thereto, radio interference may be caused to radios and TV receivers. Read the instructions for correct handling.

CE Notice — Class A Computing Device:

Warning!

This is a Class A product. In a domestic environment, this product may cause radio interference, in which case the user may be required to take adequate measures.

Achtung!

Dieses ist ein Gerät der Funkstörgrenzwertklasse A. In Wohnbereichen können bei Betrieb dieses Gerätes Rundfunkstörungen auftreten, in welchen Fällen der Benutzer für entsprechende Gegenmaßnahmen verantwortlich ist.

Avertissement!

Cet appareil est un appareil de Classe A. Dans un environnement résidentiel cet appareil peut provoquer des brouillages radioélectriques. Dans ce cas, il peut être demandé à l'utilisateur de prendre les mesures appropriées.

Contents

Preface

Overview	ix
Purpose of This Manual	ix
Intended Audience	ix
Organization	x
Conventions and Terms	xi
Overview	xi
Terms Used in This Manual	xi
Associated Documents	xii
Correspondence	xiv
Documentation Comments	xiv
Online Services	xiv
How to Order Additional Documentation	xv

Safety

Overviewxvii
Precautionsxvii

1 Product Introduction

Overview	1-1
Introduction	1-1
In This Chapter	1-1
What Is the VNswitch 900EE?	1-2
Features	1-3
Hot Swap	1-3
Configuration and Management	1-3
Bridging	1-4

Ethernet	1-4
SNMP	1-4
VLAN Secure Domains	1-5

2 Installing the VNswitch 900EE

Overview	2-1
Introduction	2-1
In This Chapter	2-1
Module Components	2-2
Introduction	2-2
Front Panel Components	2-3
Back Panel Components	2-6
How to Install the Module	2-8
Task 1: Compare the Power Ratings	2-8
Task 2: Seat the Module	2-9
Task 3: Verify Initial LED Operation	2-10
Task 4: Connect the UTP/ScTP Cable	2-11
Task 5: Connect the LDM Port Cable	2-12

3 Installing the Setup Port Cable

Overview	3-1
Introduction	3-1
In This Chapter	3-1
Setup Port Signaling Standards	3-2
Setup Port Device Cabling	3-3
Connecting to the Setup Port	3-4

4 Configuring the Module in a DEChub ONE

Overview	4-1
Introduction	4-1
In This Chapter	4-1
Assigning an IP Address	4-2
Using Menus to Configure the Module	4-3
[1] Reset with Factory Defaults	4-4
[2] Reset with Current Settings	4-5
[3] Show Current Settings	4-6
[4] Configure IP	4-7
[1] Set SNMP Read/Write Community	4-8

[2] Set In-Band Interface IP Address	4-9
[3] Set Out-of-Band Interface IP Address	4-10
[4] Set Default Gateway	4-11
[5] Go to Local Console	4-12

5 Configuring the Module in a DEChub 900

Overview	5-1
Introduction	5-1
In This Chapter	5-1
Assigning an IP Address	5-2
DEChub 900 MultiSwitch INSTALLATION MENU	5-3
[9] Start Redirect Mode	5-4
Using Menus to Configure the Module	5-5
[1] Reset with Factory Defaults	5-6
[2] Reset with Current Settings	5-7
[3] Show Current Settings	5-8
[4] Configure IP	5-9
[1] Set SNMP Read/Write Community	5-10
[2] Set In-Band Interface IP Address	5-11
[3] Set Out-of-Band Interface IP Address	5-12
[4] Set Default Gateway	5-13
[5] Go to Local Console	5-14
[10] Product-Specific Options	5-15

6 Removing the Module

Overview	6-1
Introduction	6-1
In This Chapter	6-1
Removing the Cables	6-2
Unseating the Module	6-3

A Problem Solving

Overview	A-1
Introduction	A-1
In This Appendix	A-1
Normal Power-Up	A-2
LED Descriptions	A-3
Problem Solving Using LEDs	A-5

B Connectors and Adapters

Overview	B-1
In This Appendix	B-1
Connectors and Pin Assignments	B-2
10BaseT Port (8-pin MJ) Crossover Connector	B-2
10BaseT Port (8-pin MJ) Straight-through Connector	B-3
Adapters	B-4
H8571-J Adapter	B-4
H8575-A Adapter	B-4

C Product Specifications

Overview	C-1
In This Appendix	C-1
Product Specifications	C-2
Acoustical Specifications	C-3
Connectors	C-4

Figures

2-1 Front Panel LEDs and Connectors	2-5
2-2 Back Panel Components	2-7
2-3 Power Ratings	2-8
2-4 Seating the Module	2-9
2-5 UTP/ScTP Cable Connection	2-11
2-6 LDM Port Cable Connection	2-12
3-1 Setup Port Cabling Components	3-5
6-1 Removing UTP/ScTP Cables	6-2
6-2 Removing the LDM Port Cable	6-2
6-3 Unseating the Module	6-3
B-1 8-pin MJ Crossover Connector	B-2
B-2 8-pin MJ Straight-through Connector	B-3
B-3 H8571-J Adapter	B-4
B-4 H8575-A Adapter	B-4

Tables

2-1	Front Panel LEDs and Connectors	2-3
2-2	Back Panel Components	2-6
A-1	Module LED States	A-3
A-2	Problem Solving Using the LEDs	A-5
B-1	8-pin MJ Crossover Connector Pin Assignments	B-2
B-2	8-pin MJ Straight-through Connector Pin Assignments	B-3
C-1	Product Specifications	C-2
C-2	Acoustical Specifications	C-3
C-3	German Acoustical Specifications	C-3
C-4	Connectors	C-4

Preface

Overview

Purpose of This Manual

This manual describes how to install and set up the VNswitch 900EE module. It also provides problem solving, connector and adapter, and pin assignment information.

Intended Audience

This manual is intended for use by personnel who will install and set up the VNswitch 900EE.

Organization

This manual is organized as follows:

Section	Description
Chapter 1	Provides an overview of the VNswitch 900EE and describes its features.
Chapter 2	Provides instructions for installing the VNswitch 900EE in a DEChub 900 MultiSwitch.
Chapter 3	Provides instructions for installing the setup port on the DEChub ONE and the DEChub 900 MultiSwitch.
Chapter 4	Provides information on setting up and configuring the VNswitch 900EE in a DEChub ONE.
Chapter 5	Provides information on how to configure the VNswitch 900EE in a DEChub 900 MultiSwitch.
Chapter 6	Provides information on how to remove the VNswitch 900EE from the DEChub 900 MultiSwitch.
Appendix A	Provides installation-specific problem solving information using the LEDs.
Appendix B	Provides connector and pin assignment information.
Appendix C	Provides product specifications and a parts list.

Conventions and Terms

Overview

This manual uses the following conventions.

Convention	Description
Special Type	Indicates system output in examples.
Boldface	Indicates user input in examples.
<Return>	Indicates that you should press the Return key.

Terms Used in This Manual

This book uses the following terms:

Term	Definition
Ethernet	Digital's term for its product compatibility with ISO 8802-3/ANSI/IEEE 802.3 standards and the Ethernet standards for CSMA/CD local area networks (LANs).
ScTP Cable	A 100 ohms cable that supports 10BaseT and 100BaseT compliant products.
SNMP	Simple Network Management Protocol, an industry-standard protocol for network management.
ThinWire Cable	IEEE 10Base2 coaxial cable that carries Ethernet signals.

Associated Documents

The following documents provide information relating to the module. To order any of the following documents, refer to the directions in How to Order Additional Documentation.

Title and Order Number	Description
<i>DEChub 900 MultiSwitch Owner's Manual</i> EK-DH2MS-OM	Provides installation, use, security, and troubleshooting information for the DEChub 900 MultiSwitch.
<i>DEChub ONE Installation</i> EK-DEHU2-IN	Provides installation and operation guidelines for standalone module configuration, including mounting options and cabling.
<i>DEChub ONE-MX Installation</i> EK-DEF1H-IN	Provides installation and operation guidelines for standalone module configuration, including mounting options and cabling.
<i>clearVISN Installation</i>	Provides pre- and post-installation information, as well as actual installation procedures for each application.
<i>clearVISN Product Overview Guide</i>	Provides an overview of clearVISN, an explanation of each application and descriptions of all concepts necessary to understand and use the application efficiently.
<i>clearVISN Configuration and Use Guide</i>	Provides information for starting and configuring each application, and general use information.
<i>VNswitch 900 Series Technical Overview</i>	Provides a technical overview of the VNswitch 900 family of high-density switching products.
<i>VNswitch 900 Series Switch Management</i>	Describes how to configure, monitor, and manage a VNswitch 900 series module.
<i>OPEN DECconnect Applications Guide</i> EC-G2570-42	Provides information to help plan and install networking systems based on Digital's OPEN DECconnect System and networking products.

Associated Documents

Title and Order Number	Description
<i>Event Logging System Messages Guide</i>	Describes messages logged by the Event Logging System.
<i>Bridge and Extended LAN Reference</i> EK-DEBAM-HR	Describes how bridges are used to create extended local area networks (LANs). The descriptions include the use of bridges in extended LAN configurations, information on LAN interconnections, overall bridge operation, spanning tree, bridge management, and solving bridge-related problems in a network.

Correspondence

Documentation Comments

If you have comments or suggestions about this document, send them to the Network Products Business Organization.

Attn: Documentation Project Manager
FAX: (508) 486-6093
E-MAIL: doc_feedback@lkg.mts.dec.com

Online Services

To locate product-specific information, refer to the following online services:

BBS To read the Bulletin Board System, set your modem to 8 bits, no parity, 1 stop bit and dial 508-486-5777 (U.S.).

WWW The Digital Equipment Corporation Network Products Business Home Page on the World Wide Web is located at the following addresses:

North America: <http://www.networks.digital.com>

Europe: <http://www.networks.europe.digital.com>

Australia: <http://www.digital.com.au/networks>

How to Order Additional Documentation

To order additional documentation, use the following information:

To Order:	Contact:
By Telephone	Continental USA: 1-800-DIGITAL (1-800-344-4825) Canada: 1-800-267-6215 Alaska, New Hampshire, and Hawaii: 1-603-884-6660
Electronically (USA only)	Dial 1-800-DEC-DEMO (For assistance, call 1-800-DIGITAL)
By Mail (USA and Puerto Rico)	DIGITAL EQUIPMENT CORPORATION P.O. Box CS2008 Nashua, New Hampshire 03061 (Place prepaid orders from Puerto Rico with the local Digital subsidiary: 809-754-7575)
By Mail (Canada)	DIGITAL EQUIPMENT CORPORATION LTD. 940 Belfast Road Ottawa, Ontario, Canada K1G 4C2 Attn: A&SG Business Manager
Internationally	DIGITAL EQUIPMENT CORPORATION A&SG Business Manager c/o local Digital subsidiary or approved distributor
Internally	U.S. Software Supply Business (SSB) DIGITAL EQUIPMENT CORPORATION 8 Cotton Road Nashua, New Hampshire 03063

Safety

Overview

The cautions that must be observed for the hardware described in this manual are listed in this section in English, German, French, and Spanish. Any warning or caution that appears in this manual are defined as follows:

WARNING	Contains information to prevent personal injury.
CAUTION	Contains information to prevent damage to equipment.
VORSICHT	Enthält Informationen, die beachtet werden müssen um den Benutzer vor Schaden zu bewahren.
ACHTUNG	Enthält Informationen, die beachtet werden müssen um die Geräte vor Schaden zu bewahren
DANGER	Signale les informations destinées à prévenir les accidents corporels.
ATTENTION	Signale les informations destinées à prévenir la détérioration du matériel.
AVISO	Contiene información para evitar daños personales.
PRECAUCIÓN	Contiene información para evitar daños al equipo.

Precautions

CAUTION	This action deletes all configured settings and replaces them with factory default values. All configuration settings will be lost.
ACHTUNG	Bei diesem Vorgang werden alle Konfigurationseinstellungen gelöscht und die Werkseinstellungen wieder eingesetzt. Alle Konfigurationsdaten gehen verloren.
ATTENTION	Cette action supprime tous les paramètres de configuration et les remplace par des valeurs prédéfinies. Tous les paramètres de configuration seront perdus.
PRECAUCIÓN	Esta intervención borrará todos los parámetros de configuración y los sustituirá por valores por defecto definidos de fábrica. Se perderán todos los parámetros de configuración.

Chapter 1

Product Introduction

Overview

Introduction

This chapter describes the features of the VNswitch 900EE module.

For further technical information on the VNswitch 900EE, refer to the *VNswitch 900 Series Switch Management* and the *VNswitch 900 Series Technical Overview*.

In This Chapter

Topic	Page
What Is the VNswitch 900EE?	1-2
Features	1-3

What Is the VNswitch 900EE?

What Is the VNswitch 900EE?

The VNswitch 900EE (also referred to in this manual as the module) is a 24-port SNMP manageable Ethernet switch, providing full-speed switching capability between each of its twenty-four 10BaseT 802.3/Ethernet ports.

All of the module's 24 front-panel 10BaseT 802.3/Ethernet ports are auto-configured to connect to the 400 Mb/s VNbus on the DEChub 900 backplane. Alternatively, as many as 12 ports can be individually redirected to a DEChub 900 backplane channel (LAN segment) to form a backplane LAN.

The VNswitch 900EE network module is a true backbone network switch that supports complete filtering capabilities (including source address, destination address, protocol type, and VLAN) for greater network control, increased security and bandwidth utilization, and reduced propagation of network problems.

The module includes a large address table (approximately 8,000 entries) and is fully IEEE 802.1d standards-compliant, ensuring high performance and packet integrity required in large switched networks.

The VNswitch 900EE module also offers nonvolatile flash memory for easy, non-disruptive upgrades of the device firmware using Trivial File Transfer Protocol (TFTP) load protocol. This eliminates the need to replace or upgrade hardware in the future, and avoids the associated costs and disruption to network users.

When installed into a DEChub 900 and connected to the VNbus, the module can function as an expansion module for any of the other VNswitch 900 series modules.

You can install and configure the module in a DEChub 900 MultiSwitch (also referred to in this manual as a DEChub 900) or as a standalone unit in a DEChub ONE or DEChub ONE-MX docking station (see the *DEChub ONE Installation* manual or the *DEChub ONE-MX Installation* manual). The module is fully interoperable with other modules when installed in the DEChub 900 (including both DEChub 900 and DEChub 90 modules).

The VNswitch 900EE does not support the FDDI features of the DEChub ONE-MX.

Features

The following are the features of the VNswitch 900EE. For further information, refer to the *VNswitch 900 Series Technical Overview*.

Hot Swap

The hot-swap feature allows you to install or remove the module from a DEChub 900 MultiSwitch.

Configuration and Management

The following configuration and management options are available:

- Auto-configuring at power-up.
- Support for up to 256 internal addresses for management and other purposes.
- Manageable via SNMP and/or Command Line Interface (CLI) management via Telnet or an attached terminal device.
- Upgradeable device firmware (in nonvolatile Flash memory) using Trivial File Transfer Protocol (TFTP) with clearVISN MultiChassis Manager or through the OBM port with any TFTP server.
- Features a built-in SNMP management agent. It supports a comprehensive graphical user interface (GUI), using Digital's clearVISN MultiChassis Manager, that is identical for both in-band and out-of-band management.
- Support for up to approximately 8,000 network addresses.
- Support of a Load/Dump/Management (LDM) port that allows upline dumps and downline loads of operational images.
- Provides user-configured rate limiting for broadcast and multicast packets by address and specified protocol.
- Supports backplane LANs by allowing all 10BaseT ports to be directed (through management software) to the DEChub 900 backplane.
- May be used with other VNswitch 900 modules to create various configurations involving Ethernet, Fast Ethernet, FDDI and/or ATM by connecting over the VNbus.

Features

Bridging

The following bridging features and options are available:

- High-speed local traffic filtering and forwarding.
- Full line-rate bridge forwarding - up to 750,000 packets per second per module.
- Spanning tree loop detection protocol, IEEE 802.1d compliant.
- Support for multiple spanning trees with the ability to turn off spanning tree algorithm on individual switch ports on a per-port basis.

Ethernet

The following Ethernet features and options are available:

- Twenty-four, low-cost, high-performance, switched 10BaseT Ethernet ports.
- Supports half- or full-duplex operation over all ports.
- Improves Ethernet LAN configuration flexibility and performance by dynamically switching multiple Ethernet LANs.
- Supports full-performance filtering between all 24 10BaseT ports at full Ethernet speeds (14,880 packets/second/Ethernet).
- When connected to a DEChub ONE docking station (DEF1H or DEHUA), a user can assign the module's (front panel) port 11 to the docking station's AUI port.

SNMP

The VNswitch 900EE has a built-in SNMP agent and manageability using any generic SNMP management application that supports the MIBs listed below:

- MIB-II (RFC 1213)
- Interfaces Group of MIB-II (RFC 1573)
- Bridge MIB (RFC 1493)
- Draft of IETF 803.3 MAU MIB
- DEC VLAN V1 MIB
- Digital/Proteon Comet MIB
- DEChub 900 Public Common MIB
- DEChub Internal Common MIB
- Digital Extended LAN MIB

Features

- Ethernet MIB (1643)
- SNMP support for Gets and for the following standard traps, along with many proprietary traps:
 - coldStart
 - warmStart
 - linkUp
 - linkDown

VLAN Secure Domains

The VLAN Secure Domains (VSD) support has the following features:

- Ability to group ports into VSDs.
- Ability to join VSDs in different VNswitch modules across the VNbus.
- Support of port groups within a DEChub 900 to create larger distributed multicast domains.
- Support for as many as 63 port-based VSDs across each VNbus.
- Support for multiple spanning trees per module, one per VSD.

For further information, refer to the *clearVISN Configuration and Use* manual, the *clearVISN Product Overview* manual, or the *VNswitch 900 Series Technical Overview* manual.

Chapter 2

Installing the VNswitch 900EE

Overview

Introduction

This chapter describes the front and back panel components of the VNswitch 900EE and provides the tasks for installing the module.

To install a module in a DEChub ONE or DEChub ONE-MX docking station, refer to the *DEChub ONE* or *DEChub ONE-MX Installation* manual.

In This Chapter

Topic	Page
Module Components	2-2
How to Install the Module	2-8

Module Components

Introduction

The following sections describe the front and back panel components for the VNswitch 900EE.

Table 2-1 describes the front panel components, including the icons, that are on the module, as illustrated in Figure 2-1.







Table 2-2 describes the back panel components, as illustrated in Figure 2-2.

For more information about the module's LEDs, refer to Appendix A.

Front Panel Components

Table 2-1 describes the front panel components that are illustrated in Figure 2-1.

Table 2-1: Front Panel LEDs and Connectors

Item	Icon	Name	Description
1		Power LED	Lights when the module has power.
2		Module OK LED	Lights when the module passes self-test.
3		VNbus Status LED	Shows if the module is properly attached to a VNbus backplane. ¹
4		VNbus Activity LED	Indicates network traffic. ¹
5		Load/Dump/Management (LDM) Port Status LED	Indicates the link status of the Load/Dump/Management port.
6		LDM Activity LED	Indicates the LDM port is transmitting or receiving packets.
7		LDM Port	Dedicated 10BaseT Ethernet port. Supports loads and upline dumps of an operational image. This port is wired as a straight-through connector.

(continued on next page)

¹ The VNbus Status and Traffic LEDs display different indications during a load state. Refer to the release notes for current descriptions.

Module Components





Item	Icon	Name	Description
8		Reset/Dump Button	<p>Used to either reset the module or perform an upline dump of the operational image, followed by a reset. If this button is pressed as operational code initializes, the module will reset to current settings.</p> <p>To reset while turning on the power, press and hold the button until the Module OK LED flashes. If the module is in operation mode, hold the button for 5 seconds. Use a non-conductive device to press the button.</p>
9		Address Label	Contains the lowest of 256 consecutive Media Access Control (MAC) addresses that corresponds to port 1.
10		Port Status LEDs	Show the status of the ports.
		Port Activity LEDs	Indicates network traffic level.
11		10BaseT port connectors	8-pin MJ port connectors that support both UTP and ScTP cabling. These ports are wired as crossover connectors.
12		Port Status LED	Indicates if the port is enabled or disabled and receiving a valid link.
		Port Activity LED	Indicates network traffic level.

Figure 2-1: Front Panel LEDs and Connectors



NPB-0460-96F

Module Components

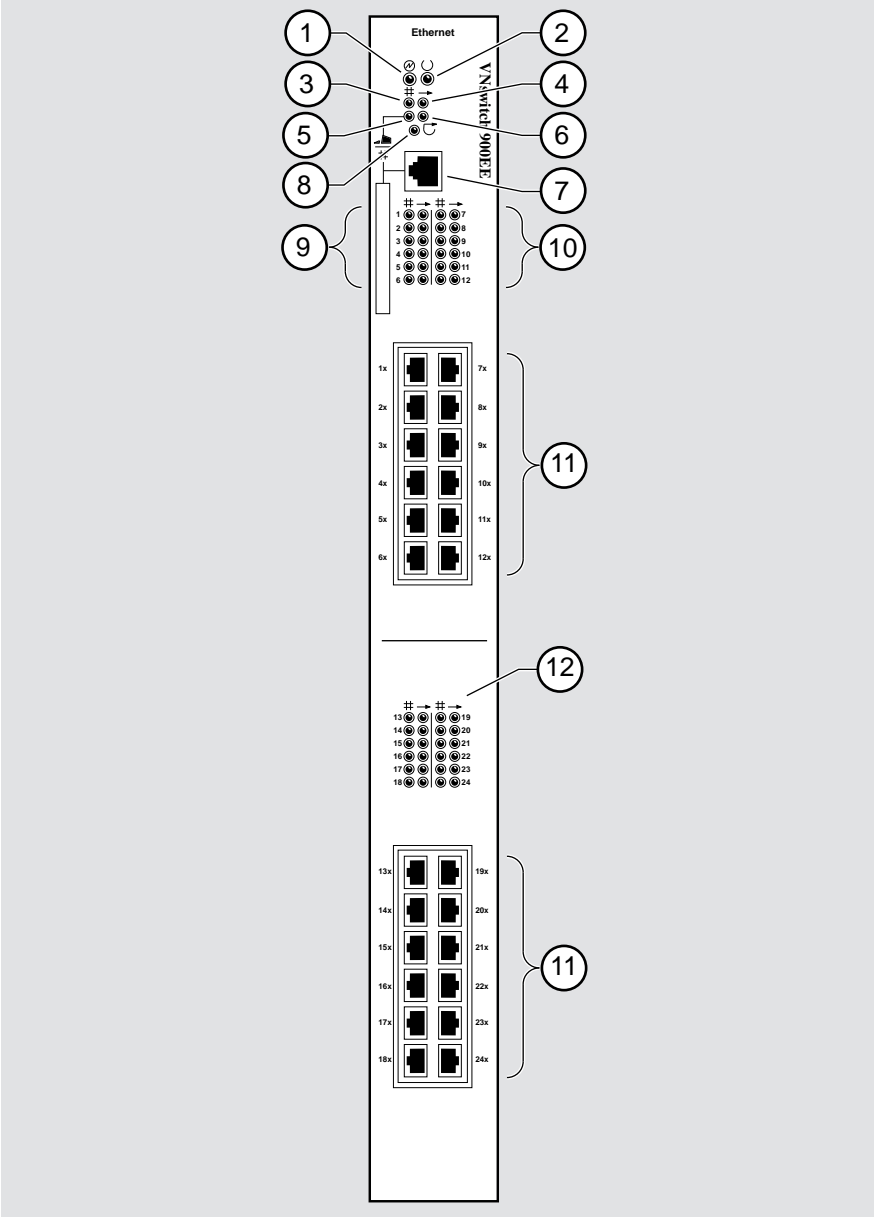
Back Panel Components

Table 2-2 describes the back panel components that are illustrated in Figure 2-2.

Table 2-2: Back Panel Components

Item	Name	Description
1	Locking tab	Locks the module into a DEChub 900 backplane or into a DEChub ONE docking station. Contains the hot-swap switch lever.
2	48-pin connector	Provides network and power connections to the module when the module is installed in a DEChub 900 or DEChub ONE docking station.
3	Grounding bolt	Provides a chassis grounding connection between the module and the DEChub 900 or the DEChub ONE docking station.
4	Manufacturing label	Lists the module's part number, serial number, revision level, and power requirements.
5	160-pin connector	Provides network and power connections to the module when the module is installed into a DEChub 900 or a DEChub ONE docking station.
6	Mounting tab	Secures the module when it is installed into a DEChub 900 or a DEChub ONE docking station.
7	Grounding fingers	Provide additional chassis grounding between the module and a DEChub 900 or a DEChub ONE docking station.

Figure 2-2: Back Panel Components

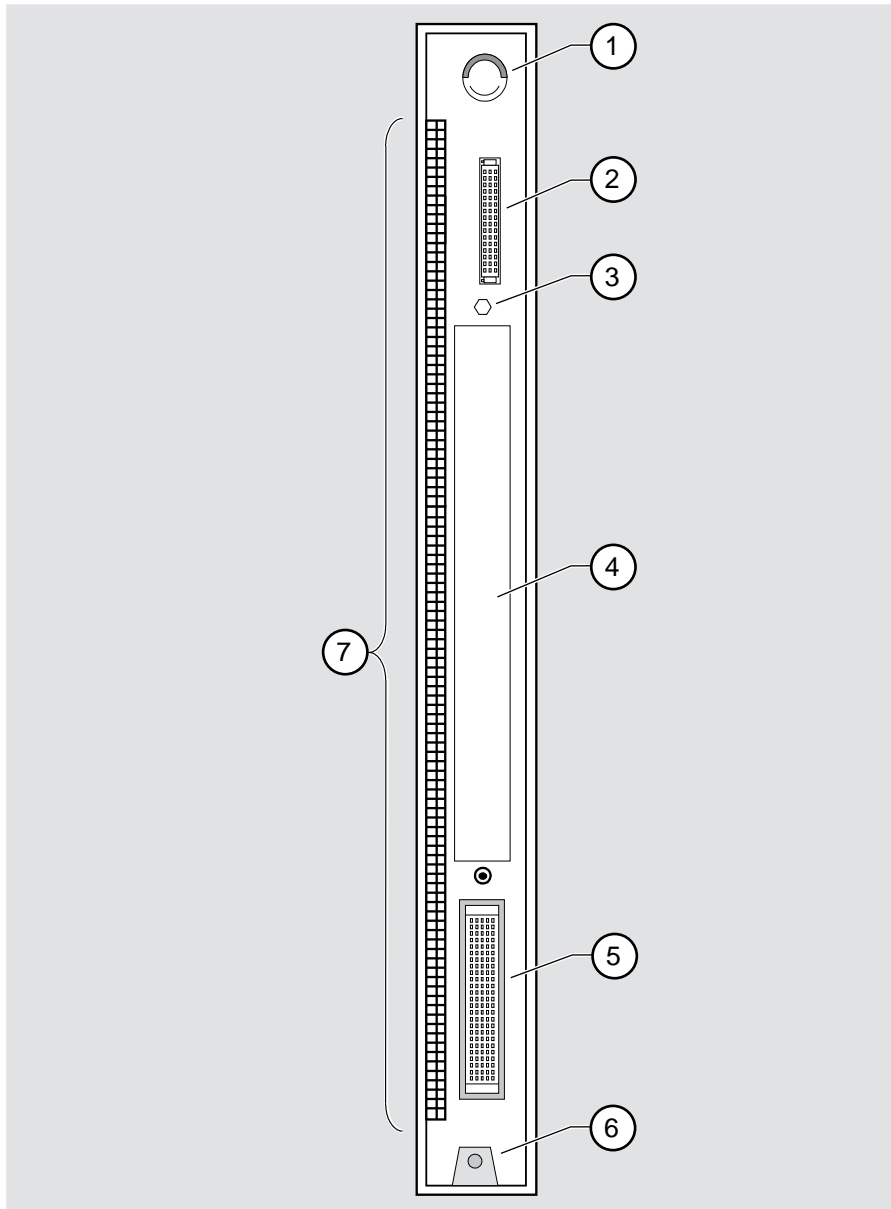

NPG-9723-95F

How to Install the Module

The hot-swap feature allows you to install the module into the DEChub 900 MultiSwitch without turning off power. Seating the module initiates the power-up.

To install the module, complete the following tasks.

Task 1: Compare the Power Ratings

Compare your module's power requirements (1) with the values shown in the Hub Manager (2) status display (Figure 2-3).

If any of the module's power requirements exceed the values shown in the status display, add another power supply (see the *DEChub 900 MultiSwitch Owner's Manual*).

Figure 2-3: Power Ratings

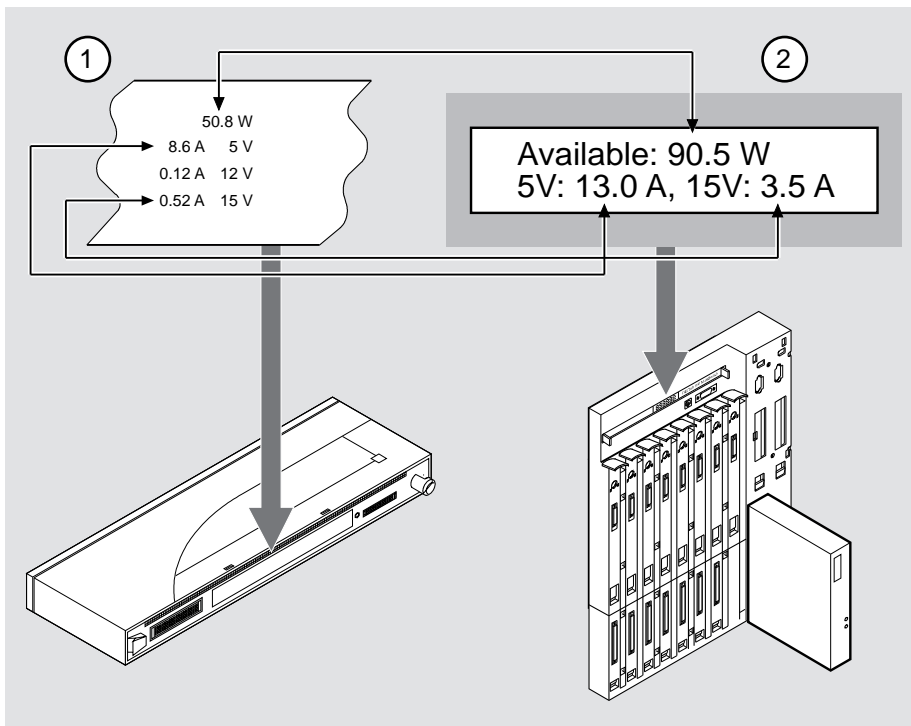

NPB-0719-96F

Task 2: Seat the Module

To seat the module into a DEChub 900 MultiSwitch (Figure 2-4), complete the following steps:

Step	Action
1	Place the module's mounting tab (1) into a mounting slot on the DEChub 900 MultiSwitch.
2	Pull up the release lever (2) to its unlocked position.
3	Pivot the module on the mounting tab, align the connectors, and firmly push the module onto the backplane connectors.
4	Press down the release lever (3) to ensure that it is locked.

Figure 2-4: Seating the Module

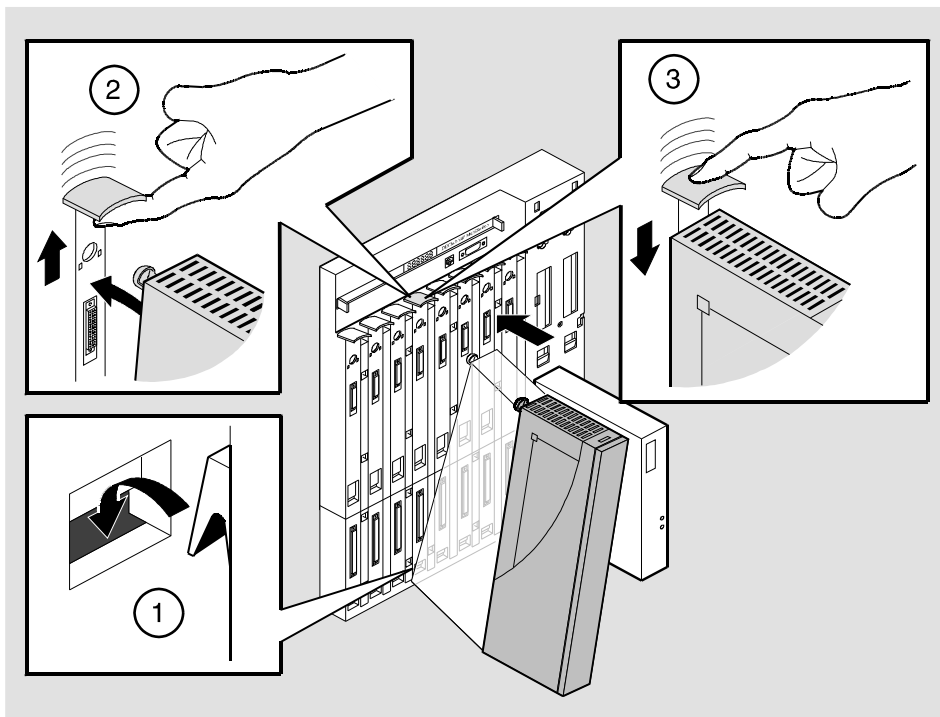

NPG-0004-95F

How to Install the Module

Task 3: Verify Initial LED Operation

If	Then
This is a new installation	Turn on the power to the DEChub 900 MultiSwitch.
The module was installed while the DEChub 900 was powered up	Seating the module initiates the module's power-up sequence. If the LEDs do not operate as described, refer to Appendix A, Problem Solving. For locations of the module's LEDs, refer to Figure 2-1.

To verify initial LED operation, check the following stages:

Stage	Description
1	When the module receives power, the Power LED lights and remains lit.
2	The module runs a self-test. <i>Note:</i> The self-test takes 30 to 60 seconds to complete.
3	After the module completes self-test, the Module OK LED lights.
4	The Hub Manager status display identifies the module as the VNswitch 900EE.

Task 4: Connect the UTP/ScTP Cable

The VNswitch 900EE uses crossover, 10BaseT, 8-pin, MJ port connectors. Before connecting the cables to the module, note the following rules:

If the device you are connecting to the module uses	Then use
Crossover connectors ¹	Crossover cables
Straight-through connectors ²	Straight-through cables

¹The sum of crossovers must always equal an odd number.

²Digital's straight-through cables are marked (=); crossover connectors and cables are marked (x).

To connect the UTP/ScTp cable (Figure 2-5), complete the following steps:

Step	Action
1	Align the release tab on the cable plug (1), with the keyway on the module's 10BaseT port connector.
2	Insert the plug into the connector, ensuring that the release tab snaps into the locked position.

Figure 2-5: UTP/ScTP Cable Connection

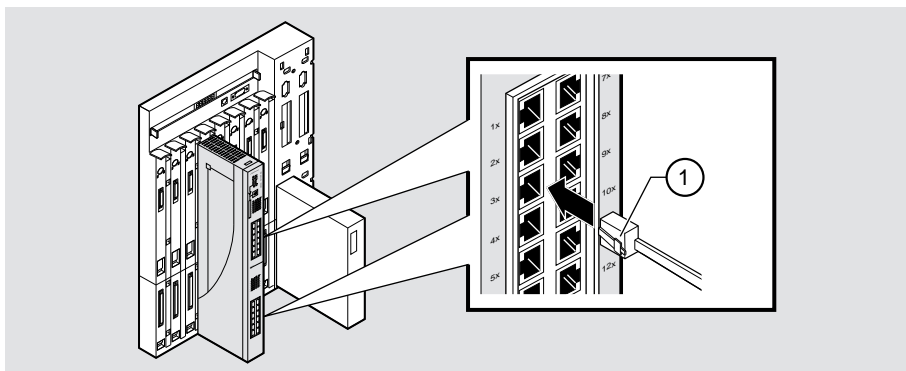

NPB-0466-96F

How to Install the Module

Task 5: Connect the LDM Port Cable

To perform a remote load/dump, the LDM cable must be connected to the LDM port.

The LDM port uses straight-through, 10BaseT, 8-pin RJ45 connectors.

To connect the LDM port cable to the LDM port (Figure 2-6), complete the following steps:

Step	Action
1	Align the release tab on the cable plug (1), with the keyway on the module's 10BaseT port connector.
2	Insert the plug into the connector (2), ensuring that the release tab snaps into the locked position.

Figure 2-6: LDM Port Cable Connection

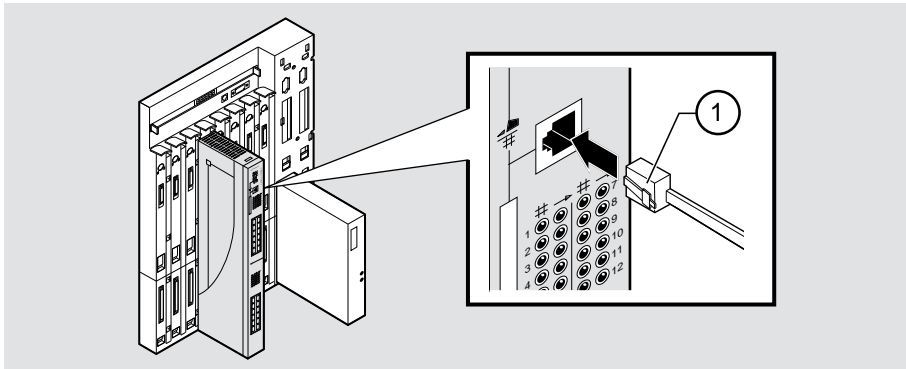

NPB-0490-96F

Chapter 3

Installing the Setup Port Cable

Overview

Introduction

The setup port on the DEChub 900 or the DEChub ONE docking station allows you to access and set VNswitch 900EE parameters. This chapter describes how to access the module from either port and how to set those parameters.

In This Chapter

Topic	Page
Setup Port Signaling Standards	3-2
Setup Port Device Cabling	3-3
Connecting to the Setup Port	3-4

Setup Port Signaling Standards

Signals from the DEChub 900 Hub Manager setup port and from the DEChub ONE docking station setup port conform to the EIA-232D signaling standard at 9600 baud. To the user, the port appears as a data terminal equipment (DTE) device.

The DEChub 900 Hub Manager setup port is compatible with devices that use the EIA-423 signaling standard.

Setup Port Device Cabling

The setup port (Figure 3-1) on the DEChub 900 MultiSwitch or the DEChub ONE docking station can be connected to a setup port device (a terminal or personal computer) by using the following cables and adapters:

If the setup port device is	Use this cable	With this adapter
PC with a 9-pin D-Sub communications port	BN24H-xx ¹	H8571-J
Terminal with a 25-pin D-Sub connector	BN24H-xx ¹	H8575-A
Terminal with a 6-pin MMJ connector	BN24H-xx ¹	Not required

¹ xx indicates cable length in meters

Connecting to the Setup Port

To connect to the setup port on the module (Figure 3-1), complete the following steps:

Step	Action
1	Ensure that the transmit and receive baud rates on the setup port device are set to 9600 baud.
2	Connect the setup port device to the setup port connector on either the DEChub 900 or the DEChub ONE docking station.

The following legend identifies the setup port cabling in Figure 3-1:

Item	Description
1	OBM Port
2	Setup Port
3	Setup Port Device

Figure 3-1: Setup Port Cabling Components

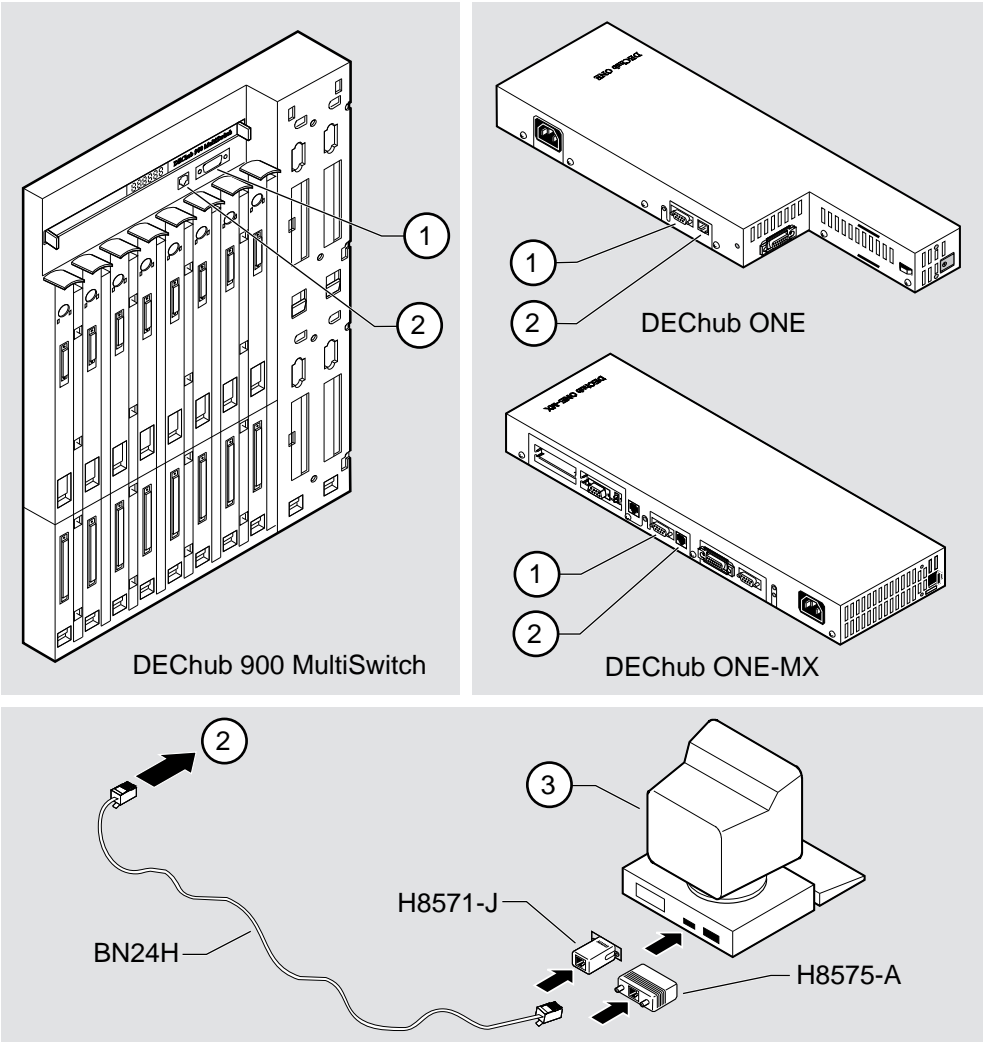

NPG-0020-95F

After all cables are connected, go to one of the following chapters:

To	Go to
Configure the module in a DEChub ONE	Chapter 4
Configure the module in a DEChub 900	Chapter 5

Chapter 4

Configuring the Module in a DEChub ONE

Overview

Introduction

This chapter describes how to configure your VNswitch 900EE when it is installed in a DEChub ONE docking station.

For further configuration information, refer to the *VNswitch 900 Series Switch Management*.

In This Chapter

Topic	Page
Assigning an IP Address	4-2
Using Menus to Configure the Module	4-3
[1] Reset with Factory Defaults	4-4
[2] Reset with Current Settings	4-5
[3] Show Current Settings	4-6
[4] Configure IP	4-7
[5] Go to Local Console	4-12

Assigning an IP Address

After the module has been installed in a DEChub ONE, the cables connected, and an IP address assigned, you need to configure the module. This is done through one of the following methods:

- A Telnet session to access the command line interface
or
- Through the command line interface, which is accessed through a terminal connected to the setup port on the DEChub 900
or
- Through clearVISN MultiChassis Manager

The setup port provides menus that allow you to access the VNswitch 900EE. These menus allow you to set up the module for basic connectivity. After setup, you can configure the module's software using commands. You can access these commands remotely via TCP/IP Telnet, or locally through the setup port on a DEChub ONE docking station.

To perform a Telnet session, you must assign an IP address. To do this, complete the following steps:

Step	Action
1	Install the module into the DEChub ONE.
2	Select the IP Configuration option from the menu.
3	Set the in-band IP address.
4	Set the default gateway, if necessary.
5	Return to the VNswitch 900EE INSTALLATION MENU and select [2] Restart with Current Settings.
6	Open a Telnet session into the module from the management station for further configuration. To access the configuration menus, press Return on the setup port device until the VNswitch 900EE INSTALLATION MENU appears. For further configuration information, refer to the <i>VNswitch 900 Series Switch Management</i> .

Using Menus to Configure the Module

This section describes the options that are available from the VNswitch 900EE INSTALLATION MENU when the module is installed in the DEChub ONE docking station. Depending on the configuration state of the module, some options may not appear.

To modify the configuration, select [5] Go To Local Console.

The following example shows the dialog associated with this option.

```
VNswitch 900EE
=====
          VNswitch 900EE INSTALLATION MENU
          [1] Reset with Factory Defaults
          [2] Reset with Current Settings
          [3] Show Current Settings
          [4] Configure IP
          [5] Go to Local Console
=====
Enter selection: 5 <Return>
```

[1] Reset with Factory Defaults

[1] Reset with Factory Defaults

This option initializes the module's configuration to factory default values by resetting the module's nonvolatile configuration storage parameters and restarting the module.

CAUTION

This action deletes all configured settings and replaces them with factory default values. All configuration settings will be lost.

The following example shows the dialog associated with this option:

```
VNswitch 900EE
=====
                        RESET WITH FACTORY DEFAULTS
* * * * *
      IMPORTANT!   IMPORTANT!   IMPORTANT!
* * * * *
This selection will delete the current configuration
settings and reset the system with the factory default
settings. All configuration settings will be lost.
* * * * *
=====
Press Y to confirm [N]:  <Return>

Press Return for Main Menu...
```

[2] Reset with Current Settings

This option resets the module but leaves the module's configured nonvolatile configuration storage parameters at their current values.

NOTE

Allow approximately 1 minute for the module to restart.

The following example shows the dialog associated with this option:

```
VNswitch 900EE
=====
                        RESET WITH CURRENT SETTINGS

This selection will reset your system with the current
configuration settings.
=====
Press Y to confirm [N] : <Return>
Press Return for Main Menu...
```

[3] Show Current Settings

[3] Show Current Settings

This option shows the module's current settings. If the module is being configured for the first time, some fields will be blank.

The following example shows the dialog associated with this option:

```
VNswitch 900EE
=====
VNswitch 900EE, 24 Ethernet/Switch, HW=v0/2,RO=v0.4,SW=v1.0
SysUpTime           : 6 days 00:03:18   2 resets
SNMP Read/Write Community : public
Default Gateway:    : not configured

Interface    IP Address    Subnet Mask    Other Info
In-Band      16.20.216.91  255.255.255.0  08-00-2B-A6-0E-05
OBM Port     16.20.66.156 255.255.255.0  Speed 9600 bps
=====

Press Return for Main Menu...
```

[4] Configure IP

This option provides you with IP configuration selections.

NOTE

For any of the IP Configuration menu options to take effect, the module needs to be reset. Use [2] Restart with Current Settings from the VNswitch 900EE INSTALLATION MENU. Allow approximately 1 minute for the module to restart and complete self-test.

The following example shows the dialog associated with this option:

```

VNswitch 900EE
=====
                        IP CONFIGURATION
* * * * *
Configuration will not take effect until module is
restarted
* * * * *

    [1] Set SNMP Read/Write Community
    [2] Set In-Band Interface IP Address
    [3] Set Out-of-Band Interface IP Address
    [4] Set Default Gateway
    [5] Return to Main Menu

=====
Enter selection number : n <Return>

```

The following pages describe the IP Configuration options:

Topic	Page
[1] Set SNMP Read/Write Community	4-8
[2] Set In-Band Interface IP Address	4-9
[3] Set Out-of-Band Interface IP Address	4-10
[4] Set Default Gateway	4-11

[4] Configure IP

[1] Set SNMP Read/Write Community

This option prompts you to enter the module's read/write community name. The community name can be used for read/write access control. The read/write community name is case sensitive.

The following example shows the dialog associated with this option:

```
VNswitch 900EE
=====
                SET SNMP READ/WRITE COMMUNITY

Format:  The format for a community name is a string,
         consisting of 4 to 31 printable ASCII characters, that
         describes the relationship between an SNMP agent and
         one or more SNMP managers. The string defines the
         authentication mechanism that is employed to validate
         the use of the community by the sending SNMP entity.
=====

Enter the community string [public] : <Return>

SNMP Read/Write community string set.

Press Return for IP Configuration Menu...
```

[2] Set In-Band Interface IP Address

This option prompts you to change or enter the module's in-band IP address, subnet mask, and default gateway for the in-band interface. If an IP address were previously configured, the screen displays an in-band IP address. The factory default setting is no in-band address.

You do not need to configure the module with a subnet mask for SNMP communications with management stations located on the same subnet as the module.

The following example shows the dialog associated with this option:

```

VNswitch 900EE
=====
                IN-BAND INTERFACE IP ADDRESS CONFIGURATION

Format: The standard 4 octet dotted decimal notation in which
        each octet of the address is represented as a decimal
        value, separated by a '.' character.

        example: 16.20.40.156

To delete the IP address, enter 0 in the appropriate address
field.

Interface      IP Address      Subnet Mask      Other Info
-----
In-Band        16.20.216.91    255.255.255.0    08-00-2B-A3-CD-08
OBM Port       16.20.66.156    255.255.255.0    Speed 9600 bps
=====

Enter the IP address [16.20.126.24] : 16.20.54.156 <Return>
Enter the Subnet Mask [255.0.0.0] : 255.255.0 0 : <Return>

Press Return for IP Configuration Menu....

```

[4] Configure IP

[3] Set Out-of-Band Interface IP Address

This option prompts you to change or enter the IP address and subnet mask for the out-of-band interface. The module does not need to be configured with a subnet mask for SNMP communications when management stations are on the same subnet as the module.

The format for these values is the standard 4-octet dotted decimal notation, where each octet of the address is represented as a decimal value, separated by a decimal point (.).

If the module is in a DEChub 900, the OBM feature allows you to manage your module through the OBM port located on the DEChub 900. To enable out-of-band management, you need to assign an OBM IP address.

The following example shows the dialog associated with this option:

```
VNswitch 900EE
=====
                OUT-OF-BAND INTERFACE IP ADDRESS CONFIGURATION

Format: The standard 4 octet dotted decimal notation in which
        each octet of the address is represented as a decimal
        value, separated by a '.' character.

                example: 16.20.40.156
.

To delete the address, enter 0 in the appropriate address
field.

=====
Interface      IP Address      Subnet Mask      Other Info
-----
In-band        16.20.216.91    255.255.255.0    08-00-2B-A3-CD-08
OBM Port       16.20.66.156    255.255.255.0    Speed 9600 bps
=====
Enter the IP address [16.20.66.156] : 16.20.54.155 <Return>
Enter the Subnet Mask [255.255.255.0] : 255 255 192 0 <Return>

Press Return for IP Configuration Menu...
```

[4] Set Default Gateway

This option sets the default gateway, if necessary, for the in-band interface. This is the address of a router that the module will use when communicating to a remote host. The default gateway address must be an address in the same subnet as your in-band address.

The following example shows the dialog associated with this option:

```
VNswitch 900EE
=====
      SET IN-BAND INTERFACE DEFAULT GATEWAY ADDRESS

Format: The standard 4 octet dotted decimal notation in which
        each octet of the address is represented as a decimal
        value, separated by a '.' character.

        example: 16.20.40.156

To delete the address, enter 0 in the appropriate
address field.
=====

Default Gateway [] : 16.126.16.254 <Return>

Default Gateway Address Set.

Press Return for IP Configuration Menu . . .
```

[5] Go to Local Console

[5] Go to Local Console

To perform additional configurations on the module, select [5] Go To Local Console from the VNswitch 900EE INSTALLATION MENU.

The system will display the copyright statements and the following prompt:

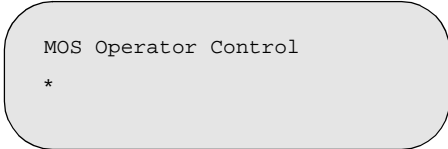

```
MOS Operator Control
*
```

From the * prompt, you can perform additional configuration. Refer to the *VNswitch 900 Series Switch Management* for further configuration information.

Chapter 5

Configuring the Module in a DEChub 900

Overview

Introduction

This chapter describes how to configure your VNswitch 900EE when it resides in a DEChub 900 MultiSwitch.

In This Chapter

Topic	Page
Assigning an IP Address	5-2
DEChub 900 MultiSwitch INSTALLATION MENU	5-3
[9] Start Redirect Mode	5-4
Using Menus to Configure the Module	5-5
[1] Reset with Factory Defaults	5-6
[2] Reset with Current Settings	5-7
[3] Show Current Settings	5-8
[4] Configure IP	5-9
[5] Go to Local Console	5-14
[10] Product-Specific Options	5-15

Assigning an IP Address

After the module has been installed in a DEChub 900 MultiSwitch, the cables connected, and an IP address assigned, you need to configure the module. This is done through one of the following methods:

- A Telnet session to access the command line interface
or
- Through the command line interface, which is accessed through a terminal connected to the setup port on the DEChub 900
or
- Through clearVISN MultiChassis Manager

To perform a Telnet session, you must assign an IP address. To do this, complete the following steps:

Step	Action
1	Install the module into a slot on the DEChub 900 MultiSwitch.
2	Redirect the DEChub 900 MultiSwitch Hub Manager setup port to the VNswitch 900EE slot.
3	Select the IP Configuration option from the menu.
4	Set the in-band IP address.
5	Set the default gateway, if necessary.
6	Return to the VNswitch 900EE INSTALLATION MENU and select [2] Restart with Current Settings.
7	Open a Telnet session into the module from the management station for further configuration. The system displays copyright statements and the following prompt:

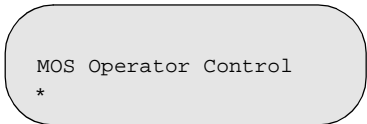
A screenshot of a terminal window showing the prompt "MOS Operator Control" followed by an asterisk (*). The text is displayed in a monospaced font within a rounded rectangular border.

```
MOS Operator Control
*
```

After the system prompt (*) appears, refer to the *VNswitch 900 Series Switch Management* for further configuration information.

DEChub 900 MultiSwitch INSTALLATION MENU

DEChub 900 MultiSwitch INSTALLATION MENU

The following example shows the DEChub 900 MultiSwitch INSTALLATION MENU.

To access the module's setup screen, you must choose option [9] Start Redirect Mode.

```
DEChub 900 MultiSwitch
=====
DEChub 900 MultiSwitch INSTALLATION MENU

[1] Reset with Factory Defaults
[2] Reset with Current Settings
[3] Show Current Settings
[4] Configure IP ...
[5] Dump Error Log
[6] Downline Upgrade
[7] Configure Out-of-Band Port ...
[8] Start Event Display Mode
[9] Start Redirect Mode
[10] Product-Specific Options ...

=====
Enter selection number: 9 <Return>

Press Return for Main Menu ...
```

[9] Start Redirect Mode

[9] Start Redirect Mode

The `Start Redirect Mode` option redirects the DEChub 900 MultiSwitch Hub Manager setup port to the setup port of any network module (such as the VNswitch 900EE) that is installed into the DEChub 900. This option allows you to configure or obtain status of an installed network module by accessing the specified network module's installation menu.

After you choose the `Start Redirect Mode` option from the DEChub 900 MultiSwitch `INSTALLATION MENU`, the screen prompts you for a slot number, as shown in the following example. After you enter the number of the slot in which the VNswitch 900EE is installed, the console is redirected to this slot.

NOTE

The slot number may change to reflect the slot number in which your module is installed.

The following example shows you how to redirect the console to a specific slot:

```
Enter the slot number for redirection (1-8): 3 <Return>
Console redirected to 3: VNswitch 900EE
Attempting connection [Ctrl/C to Abort]...
Connection successful!
```

If the redirection is successful, after you press `Return`, the `VNswitch 900EE INSTALLATION MENU` appears on your screen.

Using Menus to Configure the Module

The following screen shows the options available from the VNswitch 900EE INSTALLATION MENU when the module is operating in a DEChub 900 configuration. Depending on the configuration state of the module, some options may not appear.

Note that when your module is installed in the DEChub 900, the slot number where the module is installed appears at the top of the menu.

```
VNswitch 900EE - slot 3
=====
          VNswitch 900EX INSTALLATION MENU
          [1] Reset with Factory Defaults
          [2] Reset with Current Settings
          [3] Show Current Settings
          [4] Configure IP
          [5] Go to Local Console

          [Ctrl/C] Return to Hub Manager Installation Menu
          =====
          Enter selection:  n  <Return>
```

[1] Reset with Factory Defaults

[1] Reset with Factory Defaults

This option reboots the module, causing its configured Nonvolatile Random Access Memory (NVRAM) parameters to be initialized to factory default values followed by a module reset.

CAUTION

This action deletes all configured settings and replaces them with factory default values. All configuration settings will be lost.

The following example shows the dialog associated with this option:

```
VNswitch 900EE - slot 3
=====
                        RESET WITH FACTORY DEFAULTS

* * * * *
      IMPORTANT!   IMPORTANT!   IMPORTANT!
* * * * *

This selection will delete the current configuration
settings and reset the system with the factory default
settings. All configuration settings will be lost.
* * * * *

=====
Press Y to confirm [N]:  <Return>

Press Return for Main Menu...
```

[2] Reset with Current Settings

This option resets the module but leaves the module's configured nonvolatile configuration storage parameters at their current values.

NOTE

Allow approximately 1 minute for the module to restart.

The following example shows the dialog associated with this option:

```
VNswitch 900EE - slot 3
=====
                        RESET WITH CURRENT SETTINGS

This selection will reset your system with the current
configuration settings.
=====
Press Y to confirm [N] :  <Return>
Press Return for Main Menu...
```

[3] Show Current Settings

[3] Show Current Settings

This option shows the module's current settings. If the module is being configured for the first time, some fields will be blank. The read/write community name is case sensitive.

The following example shows the display associated with this option:

```
VNswitch 900EE - slot 3
=====
VNswitch 900EE, 24 Ethernet/Switch, HW=,RO=x,#525, SW=V1.0
SysUpTime                : 6 days 00:03:18   2 resets
SNMP Read/Write Community : public
Deafult Gateway:         : not configured

Interface      IP Address      Subnet Mask      Other Info
In-Band          16.20.216.91    255.255.255.0     08-00-2B-A6-0E-05
OBM Port         16.20.66.156   255.255.255.0     Speed 9600 bps
=====
Press Return for Main Menu...
```

[4] Configure IP

This option provides you with IP configuration selections.

NOTE

For any of the IP Configuration menu options to take effect, the module needs to be reset. Use [2] Restart with Current Settings from the VNswitch 900EE INSTALLATION MENU. Allow approximately 1 minute for the module to restart and complete self-test.

The following example shows the dialog associated with this option:

```

VNswitch 900EE
=====
                        IP CONFIGURATION
* * * * *
Configuration will not take effect until module is
restarted
* * * * *

    [1] Set SNMP Read/Write Community
    [2] Set In-Band Interface IP Address
    [3] Set Out-of-Band Interface IP Address
    [4] Set Default Gateway
    [5] Return to Main Menu

=====
Enter selection number : n <Return>
    
```

The following pages describe the IP Configuration options:

Topic	Page
[1] Set SNMP Read/Write Community	5-10
[2] Set In-Band Interface IP Address	5-11
[3] Set Out-of-Band Interface IP Address	5-12
[4] Set Default Gateway	5-13

[4] Configure IP

[1] Set SNMP Read/Write Community

This option prompts you to enter the module's read/write community name. The community name can be used for read/write access control. The read/write community name is case sensitive.

The following example shows the dialog associated with this option:

```
VNswitch 900EE - slot 3
=====
                        SET SNMP READ/WRITE COMMUNITY

Format:  The format for a community name is a string,
         consisting of 4 to 31 printable ASCII characters, that
         describes the relationship between an SNMP agent and
         one or more SNMP managers. The string defines the
         authentication mechanism that is employed to validate
         the use of the community by the sending SNMP entity.
=====

Enter the community string [public] : <Return>

SNMP Read/Write community string set.

Press Return for IP Configuration Menu...
```

[2] Set In-Band Interface IP Address

This option prompts you to change or enter the module's in-band IP address, subnet mask, for the in-band interface. If an IP address were previously configured, the screen displays an in-band IP address.

You do not need to configure the module with a subnet mask for SNMP communications with management stations located on the same subnet as the module.

The factory default setting is no in-band address.

The following example shows the dialog associated with this option:

```

VNswitch 900EE - slot 3
=====
                IN-BAND INTERFACE IP ADDRESS CONFIGURATION

Format: The standard 4 octet dotted decimal notation in which
       each octet of the address is represented as a decimal
       value, separated by a '.' character.

       example: 16.20.40.156

To delete the IP address, enter 0 in the appropriate address
field.

Interface      IP Address      Subnet Mask      Other Info
-----
In-Band        16.20.216.91    255.255.255.0    08-00-2B-A3-CD-08
OBM Port       16.20.66.156    255.255.255.0    Speed 9600 bps
=====

Enter the IP address [16.20.126.24] : 16.20.54.156 <Return>
Enter the Subnet Mask [255.0.0.0] : 255.255.0 0 : <Return>

Press Return for IP Configuration Menu.....

```

[4] Configure IP

[3] Set Out-of-Band Interface IP Address

This option prompts you to change or enter the IP address and subnet mask for the out-of-band interface. The module does not need to be configured with a subnet mask for SNMP communications when management stations are on the same subnet as the module.

The format for these values is the standard 4-octet dotted decimal notation, where each octet of the address is represented as a decimal value, separated by a decimal point (.).

If the module is in a DEChub 900, the OBM feature allows you to manage your module through the OBM port located on the DEChub 900. To enable out-of-band management, you need to assign an OBM IP address.

The following example shows the dialog associated with this option:

```
VNswitch 900EE - slot 3
=====
                OUT-OF-BAND INTERFACE IP ADDRESS CONFIGURATION

Format: The standard 4 octet dotted decimal notation in which
        each octet of the address is represented as a decimal
        value, separated by a '.' character.

                example: 16.20.40.156
.

To delete the address, enter 0 in the appropriate address
field.

=====
Interface      IP Address      Subnet Mask      Other Info
-----
In-band        16.20.216.91    255.255.255.0    08-00-2B-A3-CD-08
OBM Port        16.20.66.156    255.255.255.0    Speed 9600 bps
=====
Enter the IP address [16.20.66.156] : 16.20.54.155 <Return>
Enter the Subnet Mask [255.255.255.0] : 255 255 192 0 <Return>

Press Return for IP Configuration Menu...
```

[4] Set Default Gateway

This option sets the default gateway, if necessary. This is the address the module uses when communicating to a remote host. The default gateway address must be in the same subnet as your in-band address.

The following example shows the dialog associated with this option:

```
VNswitch 900EE - slot 3
=====
      SET IN-BAND INTERFACE DEFAULT GATEWAY ADDRESS

Format: The standard 4 octet dotted decimal notation in which
        each octet of the address is represented as a decimal
        value, separated by a '.' character.

        example: 16.20.40.156

To delete the address, enter 0 in the appropriate
address field.

=====

Default Gateway [] : 16.126.16.254 <Return>

Default Gateway Address Set.

Press Return for IP Configuration Menu . . .
```

[5] Go to Local Console

[5] Go to Local Console

To perform additional configurations on the module, select [5] Go To Local Console from the VNswitch 900EE INSTALLATION MENU.

The system will display the copyright statements and the following prompt:

```
MOS Operator Control
*
```

From the * prompt, you can perform additional configuration. Refer to the *VNswitch 900 Series Switch Management* for further configuration information

[10] Product-Specific Options

This option provides product-specific selections when you are using a DEChub 900. When selected, the option allows you to enable and disable the automatic VNbus connection.

```
DEChub MultiSwitch 900
=====
                PRODUCT-SPECIFIC OPTIONS

                [1] Enable/Disable Automatic VNbus Connection
                [2] Return to Main Menu

                Enter selection:
```

If you select the option [1] Enable/Disable Automatic VNbus Connection the following menu appears:

```
DEChub MultiSwitch 900
=====
                ENABLE / DISABLE AUTOMATIC VNbus CONNECTION

                Enabling Automatic VNbus Connection means that certain backplane
                channels will be reserved for a VNbus. The channels will be reserved
                reserved as soon as this feature is Enabled, and will remain
                reserved until this feature is Disabled. When a VNswitch module
                is inserted into the hub, it will connect automatically to the
                VNbus. The Enable function will return an error if backplane channels
                cannot be reserved due to existing conditions.

                Disabling Automatic VNbus Connection means that no backplane channels
                will be reserved for a VNbus. Inserting VNswitch modules will not
                create connections to a VNbus. If any VNswitch modules are
                connected to a VNbus when the Disable mode is selected, the VNbus
                will remain until the last VNswitch module is removed from the hub.

                =====
                Automatic VNbus connection is Enable. Would you like to Disable it? [N]

                Press Return for Product-Specific Options Menu ...
```

Chapter 6

Removing the Module

Overview

Introduction

This chapter describes how to remove the VNswitch 900EE from a DEChub 900 MultiSwitch.

To remove the VNswitch 900EE from a DEChub ONE or a DEChub ONE-MX, refer to the *DEChub ONE* or *DEChub ONE-MX Installation* manual.

In This Chapter

Topic	Page
Removing the Cables	6-2
Unseating the Module	6-3

Removing the Cables

Before the module is unseated, the UTP/ScTP and LDM cables must be removed from the module. To remove the cables (Figure 6-1 and Figure 6-2), complete these steps:

Step	Action
1	Push in the release tab (1) on the side of the connector.
2	Pull out the cable(s).

Figure 6-1: Removing UTP/ScTP Cables

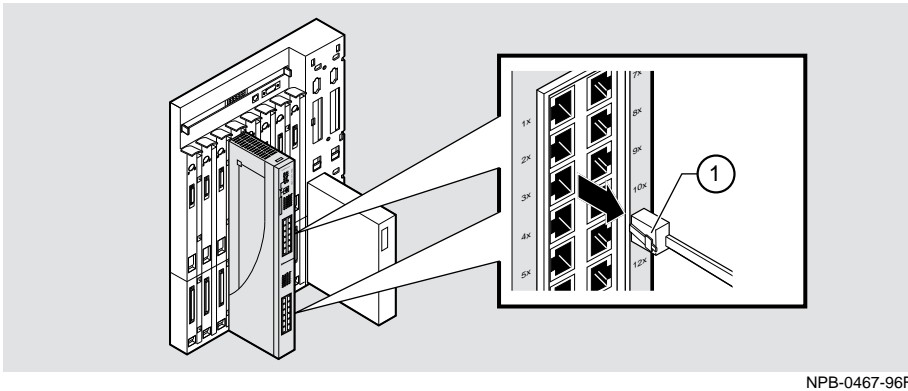

NPB-0467-96F

Figure 6-2: Removing the LDM Port Cable

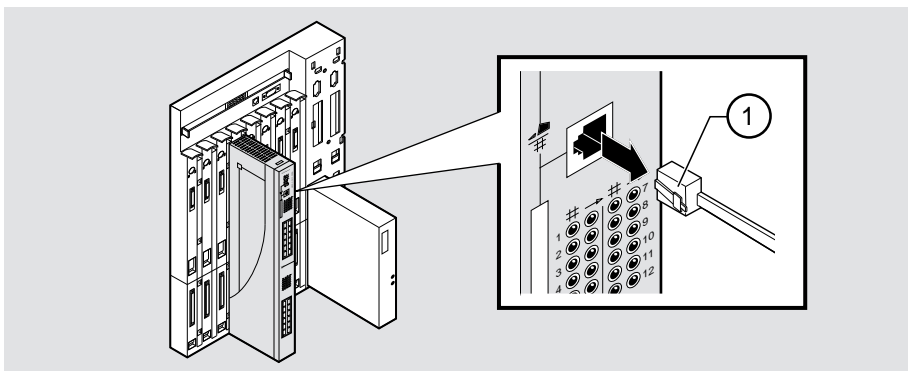

NPB-0491-96F

Unseating the Module

To unseat the module from the DEChub 900 MultiSwitch (Figure 6-3), complete the following steps:

Step	Action
1	Lift the release lever (1) at the top of the DEChub 900 MultiSwitch slot.
2	While holding up the release lever (2), pivot the module back on its bottom mounting tab.
3	Lift the module (3) from the backplane.

Figure 6-3: Unseating the Module

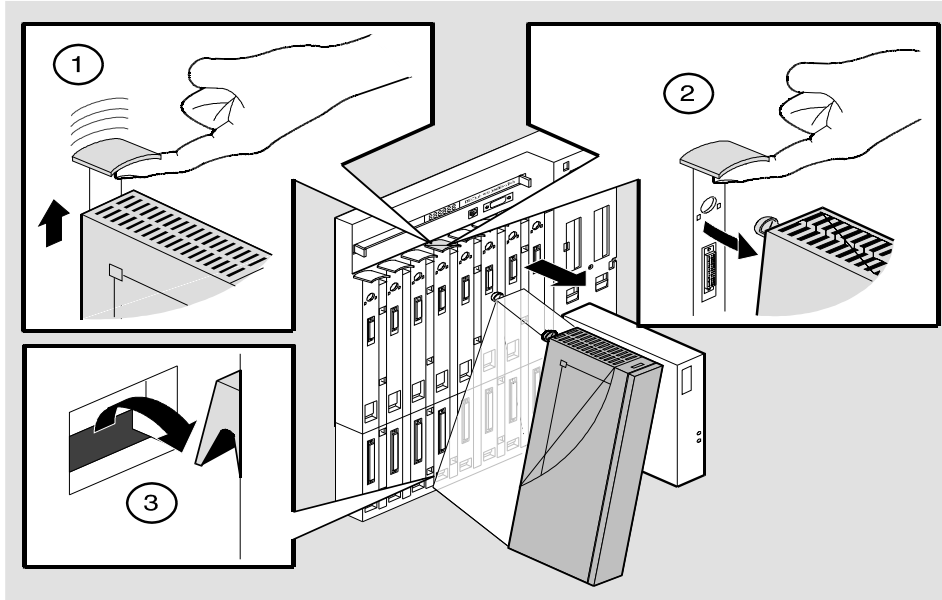

NPG-0008-95F

Appendix A

Problem Solving

Overview

Introduction

This appendix describes how to diagnose and solve problems with the module using the LED displays.

In This Appendix

Topic	Page
Normal Power-Up	A-2
LED Descriptions	A-3
Problem Solving Using LEDs	A-5

Normal Power-Up

Normal Power-Up

When the module power is initially turned on, the following events occur:

Event	Description
1	The module's Power LED lights as soon as power is applied to the unit.
2	The module initiates its built-in self-test. Flashing Port State LEDs and Port Activity LEDs indicate that the module is running various subroutines as part of the self-test.
3	After the successful completion of self-test (within 60 seconds after power is applied), the Module OK LED becomes lit.
4	The remaining LEDs now indicate their operational status.





Refer to Table A-1 for a list of states that are possible for each of the module's LEDs.

LED Descriptions

The module's LEDs provide dynamic indications of the status of the module. The LEDs can be in various states (on, off, or flashing), and can change color (green or yellow) depending on the operational status of the module or the level of activity on the network.

Table A-1 shows the states that are possible for each of the module's LEDs.

Table A-1: Module LED States

LED	Off	On (Green)	On (Yellow)	Flashing
Power LED 	No power.	Module is receiving power.	N/A	N/A
Module OK LED 	Self-test has failed or is in progress.	Module passed self-test.	N/A	Indicates a downline load or a nonfatal failure.
VNbus Status LED 	No connection	See release notes. ¹	Module is properly attached to one of the backplane VNbuses.	(Green) VNbus is disconnected by management software.
VNbus Activity LED 	No traffic.	N/A	Heavy traffic. See release notes. ¹	(Yellow) Port is receiving/transmitting traffic on the back panel.
LDM Port Status LED 	No link established.	Proper link established.	N/A	Disabled.

¹ The VNbus Status and Traffic LEDs have different indications during a load state. Refer to the release notes for current descriptions.

(continued on next page)

LED Descriptions

LED Name	Off	On (Green)	On (Yellow)	Flashing
LDM Activity LED →	N/A	Indicates high traffic.	N/A	Transmitting or receiving packets.
Port Status LEDs ⊕⊕	No valid link being received on the port. No cable is attached. Port is broken.	Port is enabled onto the front panel and is receiving a valid link.	Port failure.	(Green) Port is management disabled for forwarding but is still receiving a valid link.
Port Activity LEDs →	No traffic is being received/transmitted to the port.	Port is enabled onto the front panel and is receiving a valid link.	Port is enabled onto a back panel channel and is receiving a valid link. (In a docking station or DEChub 900)	(Green) Port is receiving/transmitting traffic on the front panel. (Yellow) Port is receiving/transmitting traffic on the back panel.

Problem Solving Using LEDs

When diagnosing a problem with the module, note that the problem is often indicated by the combined states of the module LEDs. Table A-2 lists the typical combined states of the LEDs for various error conditions that can occur during initial installation of the device, along with probable causes and corrective actions to take.

NOTE

If any of the following problems persist after taking corrective action, either replace the module or contact your Digital service representative.

Table A-2: Problem Solving Using the LEDs

Symptom	Probable Cause	Corrective Action
Power LED is off.	The module is not receiving +5 Vdc.	<p>Check the power status on the Hub Manager status display.</p> <p>If the Hub Manager status display indicates that power is available for this module, press the release lever and reseat or remove the module.</p> <p>Inspect the module's 48- or 160-pin connector for bent or broken pins. If any are bent or broken, replace the module.</p>
Module OK LED is off.	Self-test failed.	If the LED does not light within 60 seconds, lift and reseat the release lever momentarily to repeat the self-test.

(continued on next page)

Problem Solving Using LEDs

Symptom	Probable Cause	Corrective Action
Module OK LED is flashing, but module continues to operate normally.	A nonfatal error occurred.	Turn power off and on.
VNbus Status LED is off.	No connection.	Check that the module is properly attached to one of the backplane VNbuses and that the VNbus is connected by management software.
VNbus Activity LED is off.	There is low traffic activity or no traffic activity.	Ensure that there is traffic activity. If the VNbus traffic LED fails to turn on, then turn the module off momentarily by removing it from the power supply. Check that the VNbus Traffic LED blinks momentarily during the LED power-up self-test.
	The module or any other unit in the DEChub may not be connected to an active VNbus channel.	Connect a known active VNbus channel to any unit in the DEChub.
	If the module is connected to an active VNbus and the VNbus Traffic LED is off, the module is defective.	Replace the module.
LDM Port Status LED is off.	No link established.	Check that a proper link has been established.
Port Status LEDs are off.	No cable attached or port is broken.	Check cable type.

Problem Solving Using LEDs

Symptom	Probable Cause	Corrective Action
Port Activity LEDs are off.	There is low or no port activity.	Ensure that the port is present. If the Port Activity LED still fails to turn on, then turn the module off momentarily by removing it from the power supply. Check that the Port Activity LEDs blink momentarily during the LED power-up self-test.
	Ensure that the cable has activity on it. If the LED still fails to turn on, the module is defective.	Replace the module.

Appendix B

Connectors and Adapters

Overview

This appendix shows detailed illustrations of the connectors and their pin assignments, and adapters used on the VNswitch 900EE.

In This Appendix

Topic	Page
Connectors and Pin Assignments	B-2
Adapters	B-4

Connectors and Pin Assignments

10BaseT Port (8-pin MJ) Crossover Connector

Figure B-1 shows the 8-pin MJ crossover connector and its pin assignments.

Figure B-1: 8-pin MJ Crossover Connector

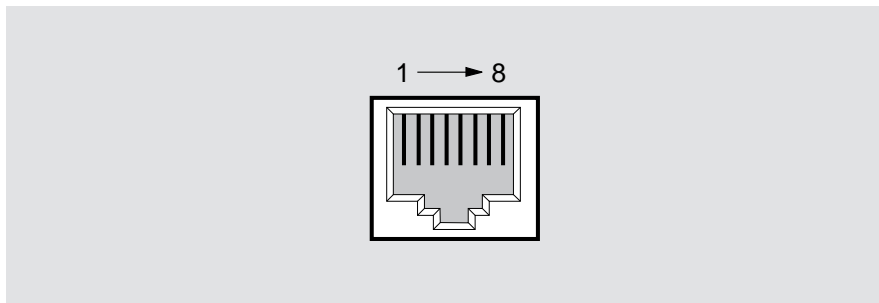

NPG-8719-95F

Table B-1 lists the pin assignments for the 8-pin MJ crossover connector.

Table B-1: 8-pin MJ Crossover Connector Pin Assignments

Pin	Assignment	Pin	Assignment
1	RX+	5	Unused
2	RX-	6	TX-
3	TX+	7	Unused
4	Unused	8	Unused

10BaseT Port (8-pin MJ) Straight-through Connector

Figure B-2 shows the 8-pin MJ straight-through port connector and its pin assignments.

Figure B-2: 8-pin MJ Straight-through Connector

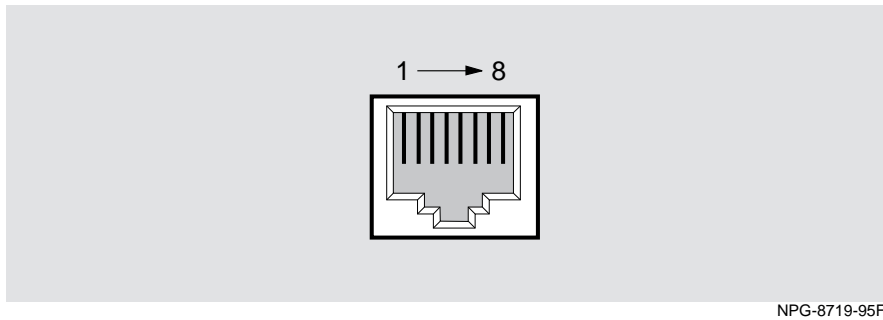

NPG-8719-95F

Table B-2 lists the pin assignments for the 8-pin MJ straight-through connector.

Table B-2: 8-pin MJ Straight-through Connector Pin Assignments

Pin	Assignment	Pin	Assignment
1	TX+	5	NC
2	TX-	6	RX-
3	RX+	7	NC
4	NC	8	NC

Adapters

H8571-J Adapter

Figure B-3 shows the H8571-J adapter (6-pin MMJ connector to 9-pin D-Sub connector) and its pin assignments.

Figure B-3: H8571-J Adapter

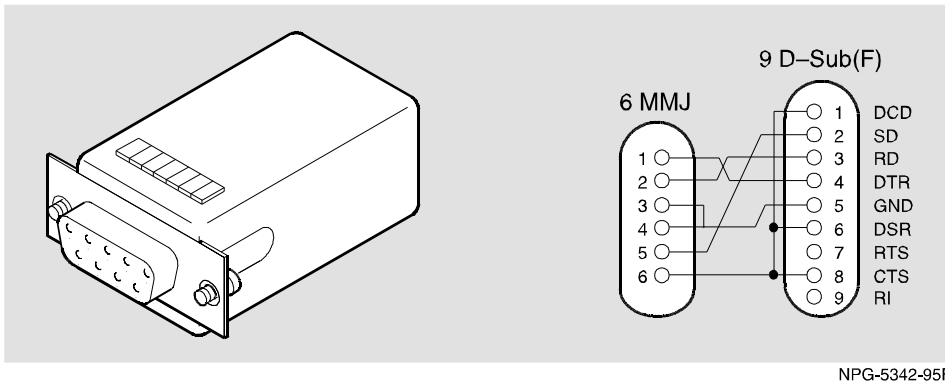

NPG-5342-95F

H8575-A Adapter

Figure B-4 shows the H8575-A adapter (6-pin MMJ connector to 25-pin D-Sub connector) and its pin assignments.

Figure B-4: H8575-A Adapter

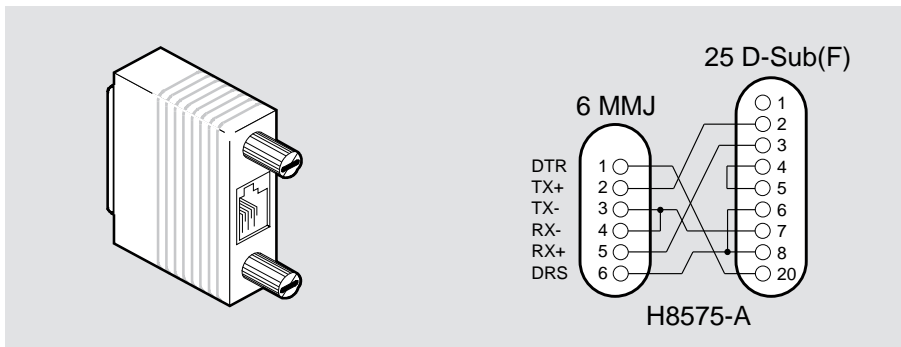

NPG-8793-95F

Appendix C

Product Specifications

Overview

This appendix lists the product and acoustical specifications for the VNswitch 900EE. It also provides a list of connectors on the VNswitch 900EE, the DEChub ONE, and the DEChub ONE-MX.

In This Appendix

Topic	Page
Product Specifications	C-2
Acoustical Specifications	C-3
Connectors	C-4

Product Specifications

Table C-1 lists the product specifications for the module.

Table C-1: Product Specifications

Parameter	Specification
Environment	
Operating temperature ¹	5°C to 50°C (41°F to 122°F)
Relative Humidity	10% to 95% noncondensing
Altitude	
• Operating	Sea level to 2400 m (8,000 ft)
• Nonoperating	Sea level to 4900 m (16,000 ft)
Power	50.8 W, total power 8.6 A, 5 Vdc 0.12 A, 12 Vdc 0.52 A, 15 Vdc
Physical	
Height	44.45 cm (17.5 in)
Width	4.45 cm (1.75 in)
Depth	15.25 cm (6 in); 25.40 cm (10 in) with a DEChub ONE docking station
Weight	1.9 kg (4.3 lb) ²
Shock (Class A/B for products weighing under 100 lbs)	10 G / 10 ms half sine pulse in three orthogonal axes
Vibration (Class C)	5 to 200 Hz sine sweep @ 0.25 G limited by 0.5mm (0.02 in) displacement DA* 200 to 500 Hz sine sweep @ 0.10 G
Certification	CE, CSA, FCC, TÜV, UL, VCCI

¹ For sites above 2400 m (8,000 ft), decrease the operating temperature specification by 1.8°C for each 1000 m or 3.2°F for each 3200 ft.

² Actual module weight (no shipping container). Include an additional 1.59 kg (3.5 lb) when attached to a DEChub ONE docking station.

Acoustical Specifications

Table C-2 and Table C-3 lists the acoustical specifications for the module in English and German.

Table C-2: Acoustical Specifications

Declared Values per ISO 9296 and ISO 7779¹

Product	Sound Power Level L_{WAd} , B	Sound Pressure Level L_{pAm} , dBA (bystander positions)
	Idle/Operate	Idle/Operate
DVNEE	5.0	37
DVNEE + DEHUA	5.3	40
DVNEE + DEF1H	5.4	39

¹ Current values for specific configurations are available from Digital Equipment Corporation representatives. 1 B = 10 dBA.

Table C-3: German Acoustical Specifications

Schallemissionswerte Werteangaben nach ISO 9296 und ISO 7779/DIN EN27779²

Produkt	Schalleistungspegel L_{WAd} , B	Schalldruckpegel L_{pAm} , dBA (Zuschauerpositionen)
	Leerlauf/Betrieb	Leerlauf/Betrieb
DVNEE	5,0	37
DVNEE + DEHUA	5,3	40
DVNEE + DEF1H	5,4	39

² Aktuelle Werte für spezielle Ausrüstungsstufen sind über die Digital Equipment Vertretungen erhältlich. 1 B = 10 dBA.

Connectors

Table C-4 provides a list connectors for VNswitch 900EE, the DEChub ONE, and the DEChub ONE-MX.

Table C-4: Connectors

Connectors	Quantity
VNswitch 900EE	
8-pin MJ (10BaseT twisted pair)	25
DEChub ONE	
8-pin MJ (setup Port)	1
DB-9 (OBM)	1
15-pin D-Sub (AUI Connector)	1
DEChub ONE-MX	
8-pin MJ (setup port)	1
6-pin MJ (OBR)	1
DB-9 (OBM)	1
15-pin D-Sub (AUI)	1
Redundant power connector (D-sub)	1
Mod PMD slots	2