

DECrepeater 90TS

Installation and Configuration

Part Number: EK-DETM1-IN. A01

September 1994

This manual describes how to install and configure the DECrepeater 90TS module.

Revision/Update Information: This is a new manual.

Copyright

September 1994

The information in this document is subject to change without notice and should not be construed as a commitment by Digital Equipment Corporation. Digital Equipment Corporation assumes no responsibility for any errors that may appear in this document.

Copyright © 1994 by Digital Equipment Corporation.
All rights reserved. Printed in U.S.A.

The postage-paid Reader's Comments form at the back of this document requests your evaluation of this document to assist us in preparing future documentation.

The following are trademarks of Digital Equipment Corporation: DEC, DECconnect, DEChub, DEChub ONE, DECndu, DECndu Plus, DECrepeater, Digital, HUBwatch, MultiSwitch, OpenVMS, ThinWire, ULTRIX, VAX, VMS, and the DIGITAL logo.

MS-DOS is a registered trademark of Microsoft Corporation.

ST is a registered trademark of American Telephone and Telegraph Company

FCC NOTICE — Class A Computing Device:

This equipment generates, uses, and may emit radio frequency energy. The equipment has been type tested and found to comply with the limits for a Class A computing device pursuant to Subpart J of Part 15 of FCC Rules, which are designed to provide reasonable protection against such radio frequency interference when operated in a commercial environment. Operation of this equipment in a residential area may cause interference; in which case, measures taken to correct the interference are at the user's expense.

VCCI NOTICE — Class 1 Computing Device:

This equipment is in the 1st Class category (information equipment to be used in commercial and/or industrial areas) and conforms to the standards set by the Voluntary Control Council for Interference by Data Processing Equipment and Electronic Office Machines aimed at preventing radio interference in commercial and/or industrial areas. Consequently, when used in a residential area or in an adjacent area thereto, radio interference may be caused to radios and TV receivers.

Read the instructions for correct handling.

CE NOTICE – Class A Computing Device:

Warning!

This is a Class A product. In a domestic environment this product may cause radio interference, in which case the user may be required to take adequate measures.

Achtung!

Dieses ist ein Gerät der Funkstörgrenzwertklasse A. In Wohnbereichen können bei Betrieb dieses Gerätes Rundfunkstörungen auftreten, in welchen Fällen der Benutzer für entsprechende Gegenmaßnahmen verantwortlich ist.

Attention!

Ceci est un produit de Classe A. Dans un environnement domestique, ce produit risque de créer des interférences radioélectriques, il appartiendra alors à l'utilisateur de prendre les mesures spécifiques appropriées.

Contents

Safety

- Introduction** 1
 - Features 2
- Front Panel** 3
- Back Panel** 4
- Installing the Module** 5
 - Installing the Module as a Standalone Unit 5
 - Removing the Back Cover 10
 - Installing the Module into a DEChub 900 11
 - Installing the Module into a DEChub 90 13
 - Connecting the UTP/STP Cables 15
- Removing the Module** 16
- Configuring the Module** 17
 - Setup Port Description 17
 - Setup Port Device Cabling 17
 - Accessing the Setup Port 18
 - Start Redirect Mode 20
 - DECRepeater 90TS Installation Menu (DEChub 90/Standalone Options) 21
 - DECRepeater 90TS Installation Menu (DEChub 900 Options) 22
 - Description of Menu Options 23
- LED Descriptions** 48
- Problem Solving Using the LEDs** 49
 - Normal Powerup 49

Contents (Cont.)

- Connector Pin Assignments** 51
 - AUI (15-pin D-Sub) Connector 51
 - Serial Port (8-pin MJ) Connector 51
 - 10BaseT Port (8-pin MJ) Connector 52
 - H8585-AC Adapter 52
 - H8571-J Adapter 53
 - H8575-A Adapter 53
 - H8584-AA Adapter 54
 - H8585-AA Adapter 54
 - Internal and External Crossover Configurations 55

- Product Specifications** 56

- Associated Documents** 58

Tables

- 1 DLU Process Description 34
- 2 Module LED States 48
- 3 Problem Solving Using the LEDs 49
- 4 DECRepeater 90TS Operating Specifications 56
- 5 Acoustical Specifications 57

Safety

Any warning or caution that appears in this manual is defined as follows:

WARNING	Contains information to prevent personal injury.
CAUTION	Contains information to prevent damage to equipment.

VORSICHT	Enthält Informationen, die beachtet werden müssen, um den Benutzer vor Schaden zu bewahren.
ACHTUNG	Enthält Informationen, die beachtet werden müssen, um die Geräte vor Schaden zu bewahren.

DANGER	Signale les informations destinées à prévenir les accidents corporels.
ATTENTION	Signale les informations destinées à prévenir la détérioration du matériel.

AVISO	Contiene información para evitar daños personales.
PRECAUCIÓN	Contiene información para evitar daños al equipo.

Safety (Cont.)

CAUTION 

This action deletes all configured settings and replaces them with factory default values. All configuration settings will be lost. [Page 24.]

ACHTUNG

Bei diesem Vorgang werden alle Konfigurationseinstellungen gelöscht und die Werkseinstellungen wieder eingesetzt. Alle Konfigurationsdaten gehen verloren.

ATTENTION

Cette action supprime tous les paramètres de configuration et les remplace par des valeurs prédéfinies. Tous les paramètres de configuration seront perdus.

PRECAUCIÓN

Esta intervención borrará todos los parámetros de configuración y los sustituirá por valores por defecto definidos de fábrica. Se perderán todos los parámetros de configuración.

Safety (Cont.)

CAUTION

If power is interrupted during Stage 3 of the DLU process, the firmware image can become corrupted. Do not turn off power to the unit or perform any action that can cause the unit to lose power during Stage 3 of the DLU process. [Pages 33, 36, and 40.]

ACHTUNG

Sollte während der Phase 3 des DLU-Prozesses eine Unterbrechung der Stromversorgung eintreten, kann das Firmwareprogramm zerstört werden. Aus diesem Grunde wird dringend empfohlen, Vorkehrungen zu treffen, daß während der Durchführung dieser Phase 3 die Systemeinheit weder ausgeschaltet noch die Stromversorgung unterbrochen werden kann.

ATTENTION

L'image du microprogramme risque d'être corrompue, en cas de coupure de courant au cours de l'étape 3 du processus DLU. Ne mettez pas l'unité hors tension et n'exécutez aucune action risquant d'entraîner une coupure d'alimentation au cours de cette étape.

PRECAUCIÓN

Si se interrumpe el suministro eléctrico durante la Etapa 3 del proceso DLU, puede dañarse la imagen del firmware. No se debe apagar la unidad ni realizar ninguna operación que pueda causar una interrupción del suministro de la unidad durante la Etapa 3 del mencionado proceso.

Introduction

The DECrepeater 90TS (also referred to in this manual as the module) is an 8-port 10BaseT Ethernet* repeater. The module provides eight shielded 10BaseT ports using 8-pin modular jack (MJ-8) connectors. The module also provides a ThinWire interface and a back cover AUI connector.

To give your workgroup LAN media flexibility and connectivity, the DECrepeater 90TS can be configured into a DEChub 900 MultiSwitch (also referred to in this manual as the DEChub 900), a DEChub 90, or as a standalone unit. One or more modules (up to 8) can be installed into the DEChub 900 or the DEChub 90.

When installing the module into a DEChub 900 or in a DEChub 90, the module's hot-swap capability allows you to install or remove the module without turning off power.

The module's eight 10BaseT ports (MJ-8 connectors) are located on the front panel, and support 100-ohm unshielded twisted pair (UTP) and 100-ohm shielded twisted-pair (STP) cables.

The module's ThinWire interface attaches to the ThinWire segment in the DEChub 900 or the DEChub 90. A side panel ThinWire BNC is also provided for standalone use. The AUI connector can only be used in the standalone configuration. The ThinWire and AUI interface connect internally to the same port, so one or the other (but not both) can be active at any given time by software configuration.

The module's front panel contains light-emitting diodes (LEDs) that indicate the status of the 10BaseT ports, the ThinWire network port, and the AUI network port. Other LEDs on the front panel indicate the status of the module, power, and network activity.

The module includes a serial port on the front panel that can be used as an installation setup port when the module is installed into a DEChub 90 or installed as a standalone unit. Using the setup menu, you can enable the module's front panel serial port for Out-of-Band Management (OBM).

NOTE: When the module is installed in a DEChub 900, you must use the Hub Manager setup port on the DEChub 900 instead of the module's setup port.

* In this manual, the term Ethernet is Digital's term for its product compatibility with the ISO 8802-3/ANSI/IEEE 802.3 standards and the Ethernet standards for Carrier Sense Multiple Access with Collision Detection (CSMA/CD) local area networks (LANs).





Introduction (Cont.)

Features

Your DECrepeater 90TS Ethernet repeater includes the following features:

- Access to ThinWire 10Base2 segment in the DEChub 900 MultiSwitch or DEChub 90.
- ThinWire 10Base2 port connector (ThinWire BNC) on the side panel, or an optional AUI connector on the back cover, available as an external network connection (when the module is installed as a standalone unit).
- Backplane access to another Ethernet LAN through a single flexible channel in a DEChub 900.
- Automatic module self-test at powerup.
- Port-level packet address security.
- In-band Simple Network Management Protocol (SNMP) management.
- OBM using SNMP over Serial Line Internet Protocol (SLIP) provides an additional path to the normal in-band management as follows:
 - Through the OBM connector on the DEChub 900 Hub Manager.
 - Through the front-panel serial port on the module when the module is installed in a DEChub 90 or as a standalone unit.
- Built-in SNMP agent supports the following management information bases (MIBs):
 - Ethernet-like Interface Type MIB (RFC 1398)
 - Repeater MIB (RFC 1516)
 - Digital Extended Repeater MIB
 - DEChub 900 Public Common MIB
 - MIB II (RFC 1213)
- Manageability using any generic SNMP management application that supports the MIBs listed above.
- Upgradeable device firmware (in nonvolatile Flash memory) using Trivial File Transfer Protocol (TFTP) with Digital's Network Device Upgrade (DECndu) Plus utility or through the setup port with any TFTP server.
- User-friendly advanced Graphical User Interface (GUI) manageability with Digital's HUBwatch Network Management Station (NMS) application.

Front Panel

- 1) **Power**  **LED** — Lights when the module has power.
 - 2) **Module OK**  **LED** — Lights when the module passes self-test. If the module fails self-test, the Module OK  LED remains off.
 - 3) **Network OK # A** **LED** — Indicates the status of the ThinWire, 10Base2 port.
 - 4) **Network Activity**  **LED** — Indicates network traffic level.
 - 5) **Network OK # B** **LED** — Indicates the status of the AUI port.
 - 6) **Port State LEDs (1 through 8)** — Show the status of the eight ports. The port LED is on when that port has a valid port connection, is off when there is no port connection, and is flashing when the port connection is disabled by network management.
- NOTE:** For more information about LED operation, refer to the section titled LED Descriptions.
- 7) **10BaseT (8-pin MJ) port connectors (1 through 8)** — Connectors for ports 1 to 8. Support both UTP and STP cabling.
 - 8) **Serial port (8-pin MJ) connector** — Multiplexed port can be used as a setup port or for OBM.
 - 9) **ThinWire port connector** — Connects through a BNC T-connector when the module is operating as a standalone unit.
 - 10) **Ethernet address label** — Shows the Ethernet address for the module.

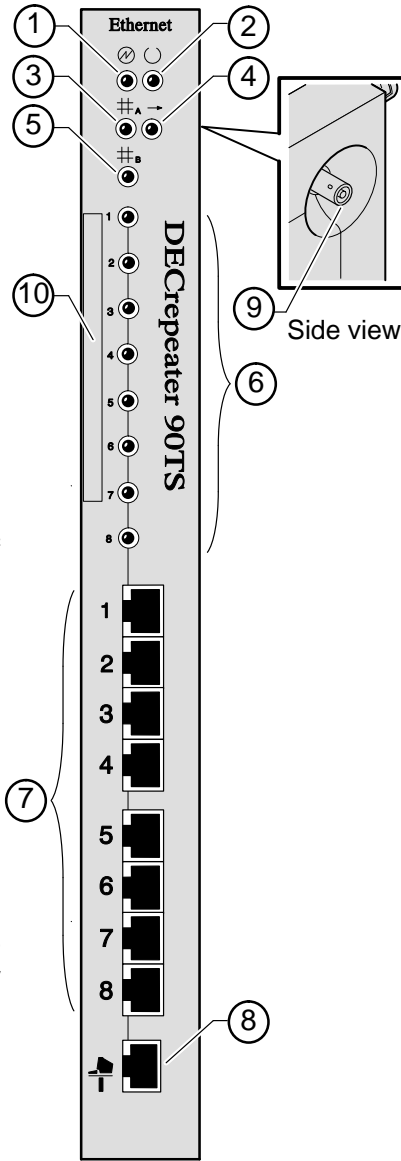

LKG-9142-941

Back Panel

- 1) **Locking tab** — Locks the module into a DEChub 900 or DEChub 90 backplane.
- 2) **48-pin connector** — Provides network and power connections to the module when the module is installed into a DEChub 900 or a DEChub 90.
- 3) **Grounding bolt** — Provides a chassis grounding connection to the module when the module is installed into a DEChub 900 or a DEChub 90.
- 4) **Power connector** — Receives dc current from the power supply. This feature is used for standalone operation only.
- 5) **Manufacturing label** — Lists the module part number, serial number, revision level, and power requirements.
- 6) **Mounting tab** — Secures the module to the backplane when the module is installed into a DEChub 900 or a DEChub 90.
- 7) **Back cover** — The back cover is used only when the module is a standalone unit. The AUI port connector is incorporated into the back cover.
- 8) **AUI (15-pin D-Sub) port connector** (Used only when the module is installed as a standalone unit.) — Ethernet 15-pin D-Sub connector connects to an external medium attachment unit (MAU) directly or using an AUI cable. Refer to the *Open DECconnect Applications Guide* for a list of MAUs that are compatible with the module.

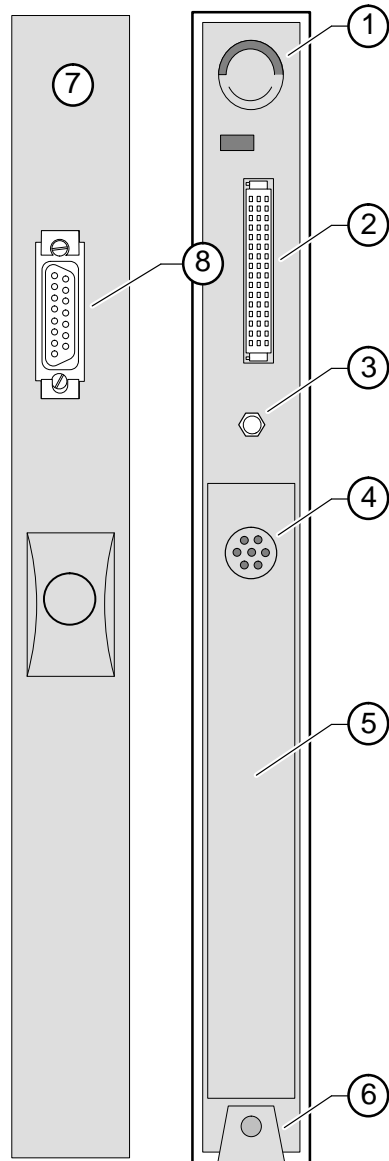

LKG-9143-94I

Installing the Module

You can install the DECrepeater 90TS as a standalone unit, or you can install the module into a DEChub 900 Multiswitch or DEChub 90. For installation instructions, refer to the following table.

If...	And...	Then...
You are installing the module as a standalone unit.		Go to the section titled Installing the Module as a Standalone Unit, at the bottom of this page.
You are installing the module into a DEChub 900 or a DEChub 90.	Your module has a back cover.	Go to the section titled Removing the Back Cover, on page 10.
You are installing the module into a DEChub 900.	Your module does not have a back cover.	Go to the section titled Installing the Module into a DEChub 900, on page 11.
You are installing the module into a DEChub 90.	Your module does not have a back cover.	Go to the section titled Installing the Module into a DEChub 90, on page 13.

Installing the Module as a Standalone Unit

You can use the DECrepeater 90TS as a standalone unit by placing it on a table, mounting it onto a wall, or installing it into a standard 19-inch rack using a shelf assembly (Digital Part Number: H9544-MS).

In standalone mode, you can operate your module with or without a back cover. If the back cover is installed, either the ThinWire port or the AUI port can be used to connect the module to the network. If the back cover is removed, only the ThinWire port is available.

The module's factory default settings automatically select either the ThinWire port or the AUI port, depending on which one is connected. If you connect both the ThinWire port and the AUI port to the network(s), the module selects the AUI port by default. Using HUBwatch, you can change the module's port selection to use either the ThinWire port or the AUI port.

NOTE: In the standalone mode, connections are normally made to **either** the ThinWire port or the AUI port, **not both**. Only one of the two ports can be active at a time. It is not necessary to place a terminator or loopback connector on the nonactive port.

Installing the Module (Cont.)

NOTE: The module continually switches between the ThinWire port and the AUI port if **all** of the following conditions are true:

- Both ports are unused
- The ThinWire port is not terminated
- The AUI port does not have a loopback connector attached

This is not an error condition.

If you are connecting only the ThinWire port, and not the AUI port, go to Step 2.

1 Connect the AUI cable or MAU to the AUI port :

- a. Push the module's AUI connector slide latch to the unlocked position.
- b. Insert the AUI cable plug or a MAU into the AUI connector.
- c. Push the module's AUI connector slide latch to the locked position.
- d. If you are using **only** the AUI port, and not the ThinWire port, go to Step 3. Otherwise, go to Step 2.

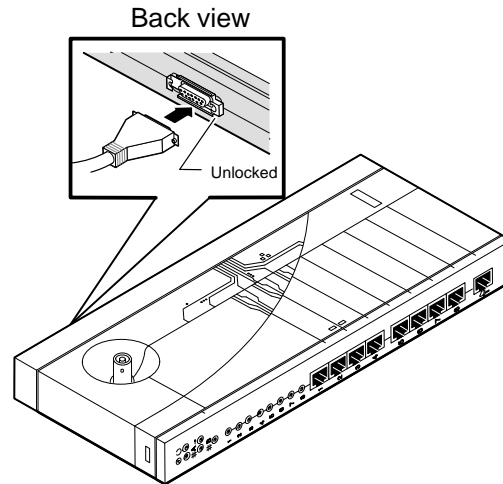

LKG-9476-94I

NOTE: To disconnect the AUI cable or MAU, push the connector slide latch to the unlocked position, then pull to disconnect.

Installing the Module (Cont.)

2 Connect the ThinWire T-connector:

- a. Attach the ThinWire T-connector to the BNC connector and turn the connector one-quarter turn to the right until the connector locks into place.
- b. Attach the ThinWire backbone segment to one of the BNC connectors on the T-connector.
- c. Attach either a terminator or a ThinWire cable to the other BNC connector. (The illustration shows a terminator attached to the BNC connector.)

If you attach a ThinWire cable, ensure that the cable is properly terminated or connected to a 10Base2 device.

NOTE: To disconnect the ThinWire T-connector, turn the connector one-quarter turn to the left until the connector clears the BNC connector stem, then disconnect the cable(s).

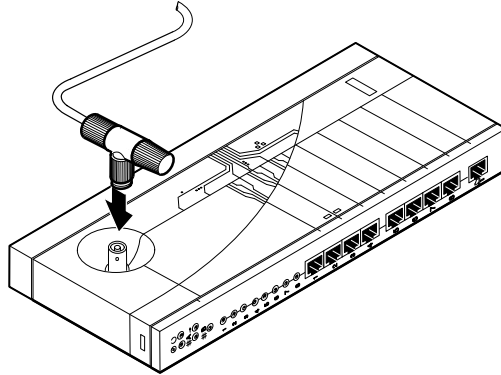

LKG-9476-94I

Installing the Module (Cont.)



3 Connect the power supply:

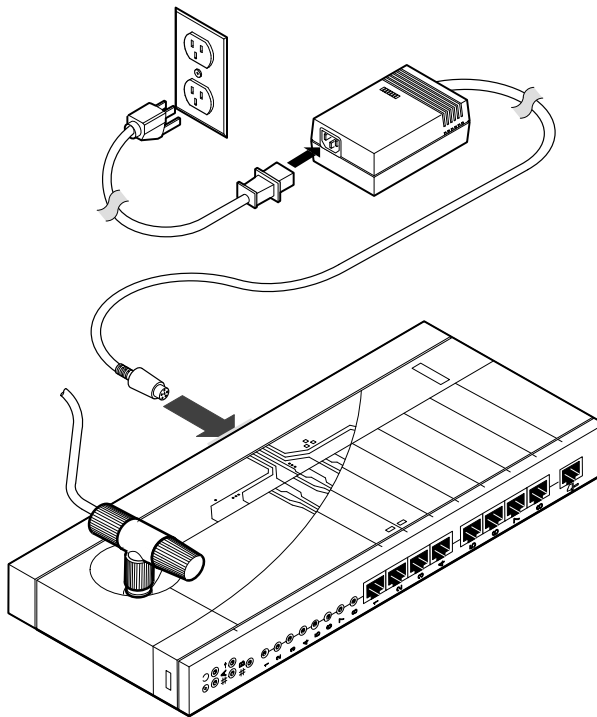

- a. Connect the cable from the power supply (Digital Part Number: H7827-BA) to the power connector on the back of the module.
- b. Plug the ac power supply cable into the power supply, then into a wall outlet.



LKG-9477-94I

Installing the Module (Cont.)

4 Verify that the module's Power  LED lights immediately and that the Module OK  LED lights within 1 minute

- a. The Power  LED lights when power is applied, then the module performs a self-test.
- b. After the module completes the self-test, the Module OK  LED lights and remains lit.

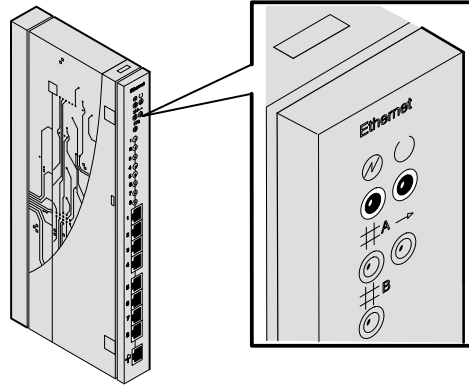

LKG-9145-941

NOTE: If the LEDs do not operate as described, refer to the section titled Problem Solving Using the LEDs .

Go to the section titled Connecting the UTP/STP Cables, on page 15.

Installing the Module (Cont.)

Removing the Back Cover

Remove the back cover if you are installing a module into a DEChub 900 or into a DEChub 90.

- 1** Lift up the latch on the back cover by inserting a flat-blade screwdriver into the top mounting hole.
- 2** With the latch up, pull the top of the back cover away, pivoting at the bottom of the module.
- 3** To install the module:
 - a. Into a DEChub 900, go to the section titled Installing the Module into a DEChub 900.
 - b. Into a DEChub 90, go to the section titled Installing the Module into a DEChub 90.

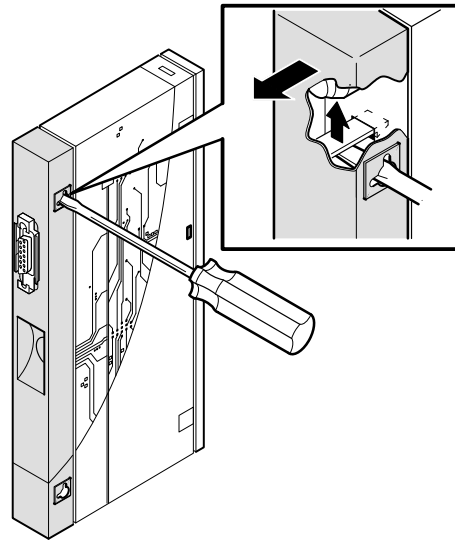

LKG-9146-94I

Installing the Module (Cont.)

Installing the Module into a DEChub 900

The DECrepeater 90TS hot-swap feature allows you to install the module into the DEChub 900 without turning off power. Seating the module initiates the powerup sequence.

- 1 Compare your module's power requirements with the values shown in the Hub Manager status display (see examples).

If any of the module's power requirements exceed the values shown in the status display, add another power supply (see the *DEChub 900 MultiSwitch Owner's Manual*).

Module's Manufacturing Label (Example)

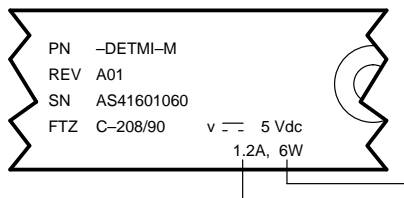

Hub Manager Status Display (Example)

Available: 90.5 W
5V: 13.0 A, 15V: 3.5 A

LKG-9539-94I



- 2 Seat the module into the DEChub 900.

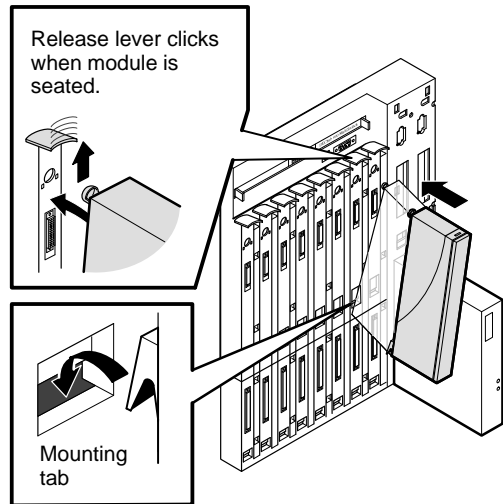

- a. Place the module's mounting tab into a mounting slot on the DEChub 900.
- b. Pivot the module on the mounting tab and align the connectors.
- c. Firmly push the module onto the backplane connectors until the release lever clicks.
- d. Press down on the release lever to ensure that it is locked.



LKG-8727-93I

Installing the Module (Cont.)

3 Verify that the module's Power  LED lights immediately and that the Module OK  LED lights within 1 minute.

- a. The Power  LED lights when power is applied, then the module performs a self-test.
- b. After the module completes self-test, the Module OK  LED lights and remains lit, then the Hub Manager status display shows:

DECrepeater 90TS
up.

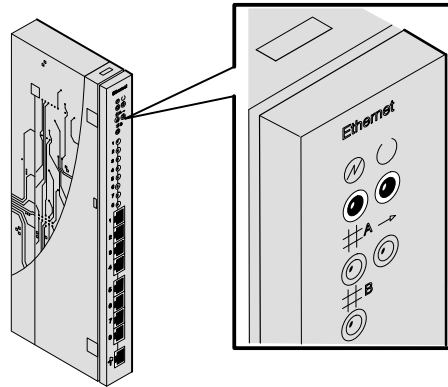

LKG-9551-941

NOTE: If the LEDs do not operate as described, refer to the section titled Problem Solving Using the LEDs .

Go to the section titled Connecting the UTP/STP Cables, on page 15.

Installing the Module (Cont.)

Installing the Module into a DEChub 90



The DECpeater 90TS hot-swap feature allows you to install the module into the DEChub 90 without turning off power. Seating the module initiates the powerup sequence.

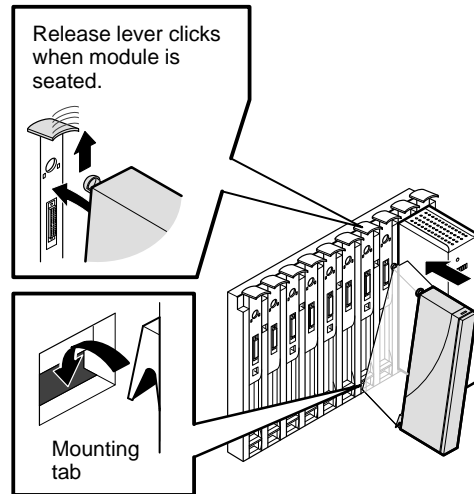

- 1** **Seat the module into the DEChub 90.**
 - a. Place the module's mounting tab into the mounting slot of the DEChub 90.
 - b. Pivot the module on the mounting tab and align the connectors.
 - c. Firmly push the module onto the backplane connectors until the release lever clicks.
 - d. Press down on the release lever to ensure that it is locked.



LKG-8837-93I

Installing the Module (Cont.)

2 Verify that the module's Power  LED lights immediately and that the Module OK  LED lights within 1 minute

- a. The Power  LED lights when power is applied, then the module performs a self-test.
- b. After the module completes self-test, the Module OK  LED lights and remains lit.

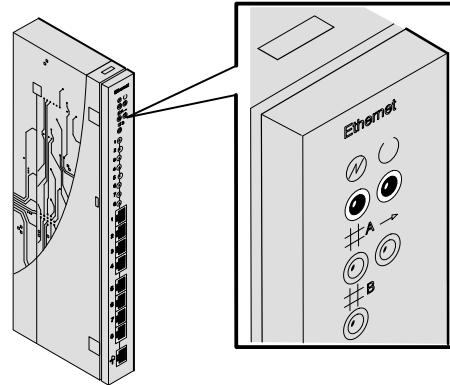

LKG-9551-941

NOTE: If the LEDs do not operate as described, refer to the section titled Problem Solving Using the LEDs, on page 49.

Go to the section titled Connecting the UTP/STP Cables, on the following page.

Installing the Module (Cont.)

Connecting the UTP/STP Cables

The DECrepeater 90TS module uses crossover 10BaseT (8-pin MJ) port connectors. The appropriate UTP/STP cable type, crossover or straight-through, is required to ensure that the module's transmit/receive signals connect correctly to the transmitter/receiver of the connected device.

Before connecting the cables to the module, note the following:

- If the device you are connecting to the module uses straight-through connectors, use straight-through cables.
- If the device you are connecting to the module uses crossover connectors, use crossover cables.
- The sum of the number of crossovers must always equal an odd number.

NOTE: Digital's straight-through cables are marked (=); crossover connectors (and cables) are marked (X).

If you need help determining the appropriate cable type to use, refer to the section titled Connector Pin Assignments, on page 51.

1 Connect the UTP/STP cables:

- a. Align the release tab on the cable plug with the keyway on the module's 10BaseT (8-pin MJ) port connector.
- b. Insert the plug into the connector, ensuring that the release tab snaps into the locked position.

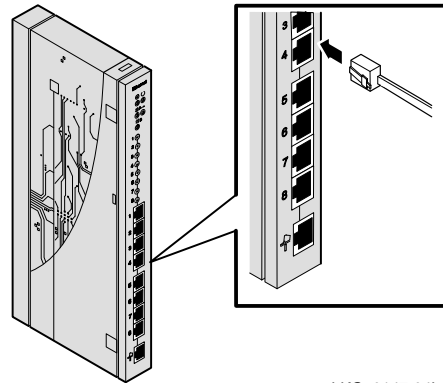

LKG-9147-94I

NOTE: To disconnect the UTP/STP cables, press the release tab.

After all cables are installed, go to the section titled Configuring the Module, on page 17.

Removing the Module

- 1** Disconnect the UTP/STP port cables from the module.
 - a. Press the release tab on the 8-pin MJ connector.
 - b. Disconnect the cable.

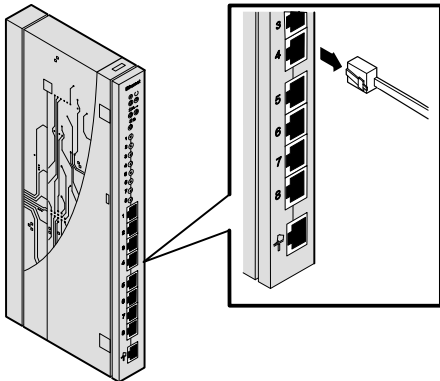

LKG-9148-94I

- 2** Unseat the module from the DEHub900 or the DEHub 90.
 - a. Lift the release lever located on the top of the DEHub 900 slot or the DEHub 90 slot.
 - b. Pivot the module back on its bottom mounting tab, and disengage the module from the backplane.

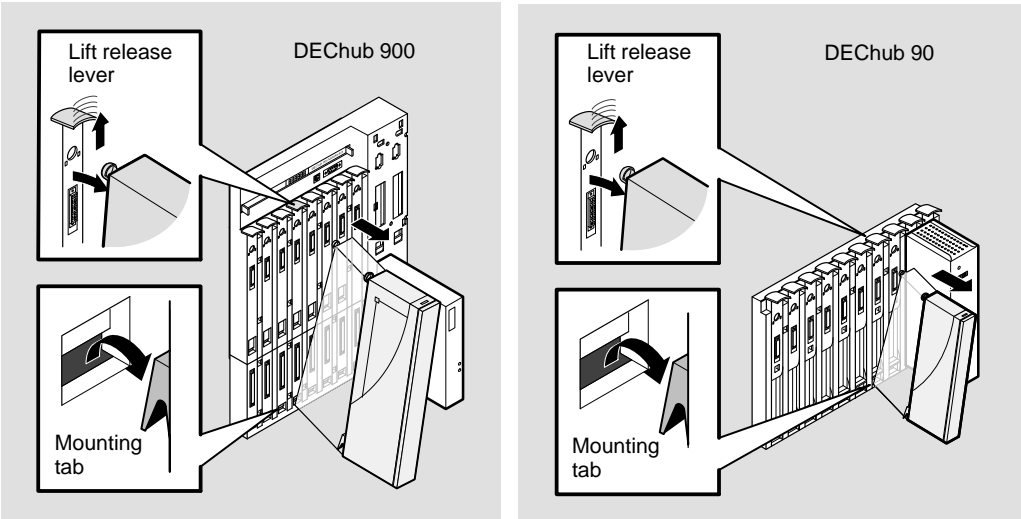

Configuring the Module

Setup Port Description

The setup port on the DEChub 900 MultiSwitch or on the module's front-panel serial port (when the module is operating as a standalone unit or in a DEChub 90) allows you to access and set DECrepeater 90TS parameters. This section describes how to access the module from either port and set those parameters.

NOTE: The setup port screen displays illustrated in this manual may vary slightly from the actual screen displays on your setup port device.

The signals from the DEChub 900 Hub Manager setup port and from the DECrepeater 90TS front-panel serial port conform to the EIA-232D signaling standard at 9600 baud. To the user, the port appears as a data terminal equipment (DTE) device.

NOTE: Devices that use the EIA-423 signaling standard are compatible with the DEChub 900 Hub Manager setup port and the DECrepeater 90TS front-panel serial port.

Setup Port Device Cabling

The front-panel serial port on the module or the Hub Manager setup port on the DEChub 900 can be connected to a setup port device (a terminal or personal computer), using the following cables and adapters (not included in the shipping kit).

Cable/Adapter Type	Connecting Setup Port Device
BN24H-xx ¹	A terminal with a 6-pin MMJ connector
BN24H-xx ¹ /H8575-A	A terminal with a 25-pin D-Sub connector
BN24H-xx ¹ /H8571-J	A PC with a 9-pin D-Sub communications port

¹ xx indicates cable length in meters.

Configuring the Module (Cont.)

Accessing the Setup Port

To use one of the ports to configure the module, do the following:

1. Ensure that the transmit and receive baud rates on the setup port device are set to 9600 baud.
2. Connect the setup port device as follows:
 - a. If you are installing the module into a DEChub 900, connect the setup port device cable to the setup port on the DEChub 900 (see illustration).
 - b. If you are installing the module into a DEChub 90 or as a standalone unit, connect the setup port device cable to the front-panel serial port on the module (see illustration).

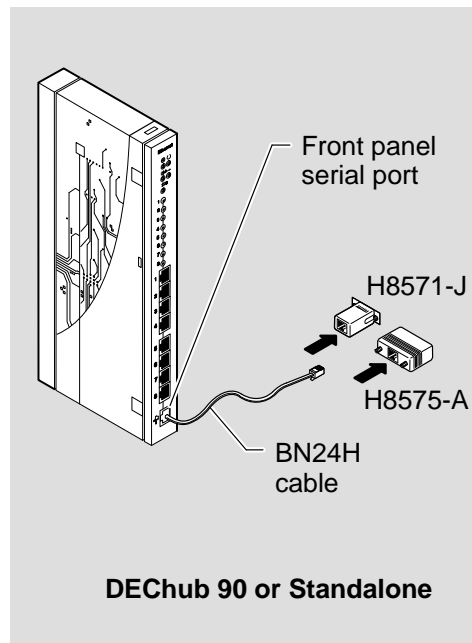
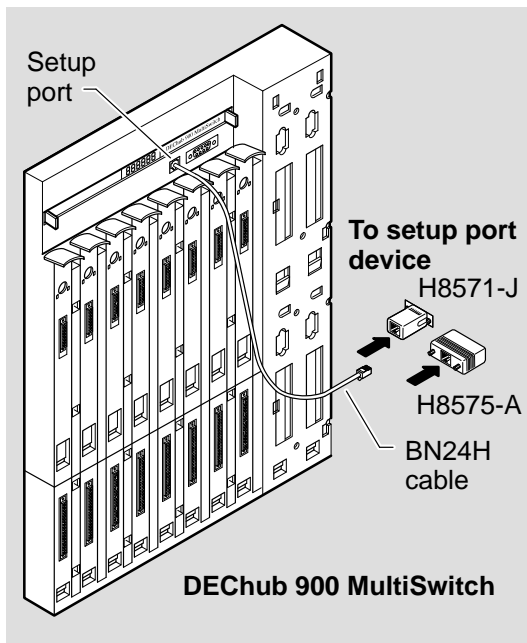

LKG-8825-941

- c. Choose option 13, then go to the section titled Start Redirect Mode, on page 20.

Configuring the Module (Cont.)

3. Press **Return** on the setup port device a few times until a menu appears.
 - a. If the setup port device is connected to the module's front-panel serial port, the DECrepeater 90TS INSTALLATION MENU appears. Go to the section titled DECrepeater 90TS Installation Menu (DEChub90/Standalone Options), on page 21.
 - b. If the setup port device is connected to the Hub Manager setup port on the DEChub 900, the DEChub 900 MultiSwitch INSTALLATION MENU appears (see following example).

The following is an example of the DEChub 900 MultiSwitch INSTALLATION MENU:

```
DEChub 900 MultiSwitch
=====
DEChub 900 MultiSwitch INSTALLATION MENU

[1] Reset with Factory Defaults
[2] Reset with Current Settings
[3] Show Current Settings
[4] Set SNMP Read/Write Community
[5] Add SNMP Trap Addresses
[6] Delete SNMP Trap Addresses
[7] Dump Error Log
[8] Set In-Band Interface IP Address
[9] Downline Upgrade
[10] Set Out-of-Band Interface IP Address
[11] Set Out-of-Band Interface Port Speed
[12] Start Event Display Mode
[13] Start Redirect Mode

=====
Enter selection : 13 Return
```

Choose option 13, then go to the section titled Start Redirect Mode.

The DECrepeater 90TS does not support Option [9] Downline Upgrade from this menu. You must choose Option [13] Start Redirect Mode to perform a downline upgrade to this module.

- c. Go to the section titled Start Redirect Mode, on the following page.

Configuring the Module (Cont.)

Start Redirect Mode

The `Start Redirect Mode` option redirects the DEChub 900 Hub Manager setup port to the setup port of any network module that supports this function (such as the DECrepeater 90TS) that is installed in the DEChub 900. Choosing this option allows you to configure or obtain status of an installed network module by accessing the module's installation menu.

After you choose the `Start Redirect Mode` option from the Hub Manager `INSTALLATION MENU`, the screen prompts you for a slot number, as shown in the following code example.

The following example shows how to select a slot number (user response is shown in **boldface type**):

```
Enter selection: 13
=====
Enter the slot number for redirection: (1-8): 3 
Setup port redirected to 3: DECrepeater 90TS
Attempting to connect ...
=====
Connection successful!
```

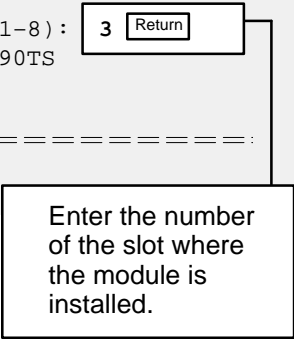

After you press , the DECrepeater 90TS `INSTALLATION MENU` appears on your screen. Go to the section titled DECrepeater 90TS Installation Menu (DEChub 900 Options), on page 22.

Configuring the Module (Cont.)

DECrepeater 90TS Installation Menu (DEChub 90/Standalone Options)

This section lists the options available from the DECrepeater 90TS INSTALLATION MENU when the module is installed into a DEChub 90 or as a standalone unit.

The following is an example of the DECrepeater 90TS INSTALLATION MENU:

```
DECrepeater 90TS
=====
DECrepeater 90TS INSTALLATION MENU

[1] Reset with Factory Defaults
[2] Reset with Current Settings
[3] Show Current Settings
[4] Set SNMP Read/Write Community
[5] Add SNMP Trap Addresses
[6] Delete SNMP Trap Addresses
[7] Dump Error Log
[8] Set In-Band Interface IP Address
[9] Set In-Band Interface Default Gateway Address
[10] Downline Upgrade
[11] Set Out-of-Band Management (OBM)Interface IP Address
[12] Set Out-of-Band Management (OBM) Port Speed
[13] Module-Specific Options

=====
Enter selection : 1 Return
```

Choose an option, then go to the section titled Description of Menu Options.

If you need to assign an IP address to the module, choose this option.

Configuring the Module (Cont.)

DECrepeater 90TS Installation Menu (DEChub 900 Options)

This section shows the options available from the DECrepeater 90TS INSTALLATION MENU when the module is installed into the DEChub 900.

The following is an example of the DECrepeater 90TS INSTALLATION MENU:

```
DECrepeater 90TS Slot 3
=====
DECrepeater 90TS INSTALLATION MENU

[1] Reset with Factory Default
[2] Reset with Current Settings
[3] Show Current Settings
[4] Set SNMP Read/Write Community
[5] Add SNMP Trap Addresses
[6] Delete SNMP Trap Addresses
[7] Dump Error Log
[8] Set In-Band Interface IP Address
[9] Set In-Band Interface Default Gateway Address
[10] Downline Upgrade

[Ctrl/C] Return to DEChub 900 MultiSwitch INSTALLATION MENU
=====

Enter selection : 1 Return
```

Indicates the DEChub slot number where the module is installed.

Choose an option, then go to the section titled Description of Menu Options, on page 23.

If you need to assign an IP address to the module, choose this option.

Configuring the Module (Cont.)

Description of Menu Options

This section describes the menu options that are available from the `DECrepeater 90TS INSTALLATION MENU`. Note that the out-of-band management options apply to the module only when it is installed into a DEChub 90 or it is in standalone mode.

[1] Reset with Factory Defaults

This option resets the module, causing **most** of the module's configured NVRAM parameters to be initialized to factory default values.

Following are examples of the module's configured NVRAM parameters that are reset to factory defaults:

- SNMP read/write community name — this name is reset to `PUBLIC`.
- SNMP trap addresses —all SNMP trap addresses are deleted.
- In-band interface IP address — this address is deleted.
- In-band interface default gateway address — this address is deleted.
- Out-of-band interface IP address — this address is deleted.
- Out-of-band interface port speed — reset to 9600.

Following are the **only** parameters that are **not** reset:

- Serial number
- Reset count
- Error log data

Configuring the Module (Cont.)

[1] Reset with Factory Defaults (Cont.)

CAUTION  This action deletes all configured settings and replaces them with factory default values. All configuration settings will be lost.

NOTE: Allow approximately 1 minute for the module to reset and complete self-test.

The following is an example of the dialog associated with this option (user response is shown in **boldface type**):

```
Enter selection : 1
DECrepeater 90TS - slot 3
=====
                        RESET WITH FACTORY DEFAULTS
* * * * *
*   IMPORTANT!           IMPORTANT!           IMPORTANT!   *
* * * * *
* This selection will delete the current configuration *
* settings and reset the system with the factory default *
* settings. All configuration settings will be lost. *
* * * * *
=====

Press Y to confirm [N] : Return
Press Return for Main Menu ...
```

Configuring the Module (Cont.)

[2] Reset with Current Settings

This option resets the module but leaves the module's configured NVRAM parameters at their current values.

NOTE: Allow approximately 1 minute for the module to reset and complete self-test.

The following is an example of the dialog associated with this option (user response is shown in **boldface type**):

```
Enter selection : 2
DECrepeater 90TS - slot 3
=====
                RESET WITH CURRENT SETTINGS
                This selection will reset your system with the
                current configuration settings.
=====

Press Y to confirm [N] : Return
Press Return for Main Menu ...
```

Configuring the Module (Cont.)

[3] Show Current Settings

This option shows the module's current settings.

NOTE: If the module is being configured for the first time some fields are blank.

The following is an example of the display associated with this option:

```
Enter selection : 3
DECrepeater 90TS Slot 3
=====
DECrepeater 90TS, 8 port TP Ethernet Rptr SNMP HW=v2 RO=v01.00 SW=v1.
SysUpTime : 01:36:00
SNMP Read/Write Community : public
SNMP Trap Addresses : Not Configured
Status of last downline upgrade : No Status
In Band Interface Hardware Address : 08-00-2B-A3-4C-70
In-Band Interface IP Address : 16.20.216.179
In-Band Interface Default Gateway Address : Not Configured
=====
Press Return to Continue ...
```

Configuring the Module (Cont.)

[4] Set SNMP Read/Write Community

This option prompts you to enter the module's read/write community name.

The format for a community name is a string consisting of 4 to 31 printable ASCII characters. This community name can be used by SNMP managers for read/write access control.

The following is an example of an SNMP read/write community name: `boston29`

The following is an example of the dialog associated with this option (user response is shown in **boldface type**):

```
Enter selection : 4
DECrepeater 90TS Slot 3
=====
SET SNMP READ/WRITE COMMUNITY
Format: The format for a community name is a string,
        consisting of four to thirty-one printable ASCII
        characters, that describes the relationship between an
        SNMP agent and one or more SNMP managers. The string
        defines the authentication mechanism that is employed
        to validate the use of the community by the sending
        SNMP entity.
=====
Enter the community string [public] : boston29 Return
SNMP Read/Write community string set.
Press Return for Main Menu ...
```

Configuring the Module (Cont.)

[5] Add SNMP Trap Addresses

This option prompts you to enter IP addresses to which SNMP traps will be sent from the module.

The format for an SNMP trap address is the standard 4-octet dotted decimal notation, where each octet of the address is represented as a decimal value, separated by a decimal point (.).

The following is an example of an SNMP trap address: 16.20.54.156

The following is an example of the dialog associated with this option (user response is shown in **boldface type**):

```
Enter selection : 5
DECrepeater 90TS - slot 3
=====
          ADD SNMP TRAP ADDRESSES
Format: The standard 4 octet dotted decimal notation in which
        each octet of the address is represented as a decimal
        value, separated by a '.' character.
        example: 16.20.54.156
=====
Configured SNMP Trap Addresses: 16.20.216.81
                               Trap address [] : 16.20.54.156 
                               Trap address added! Add another? [] : 
                               Press Return for Main Menu ...
```

Enter the SNMP trap address that you have chosen, then press Return.

Appears only if the module has been previously configured.

Configuring the Module (Cont.)

[6] Delete SNMP Trap Addresses

This option prompts you to select SNMP trap addresses for deletion.

The format for an SNMP trap address is the standard 4-octet dotted decimal notation, where each octet of the address is represented as a decimal value, separated by a decimal point (.).

The following is an example of an SNMP trap address: 16.20.54.156

The following is an example of the dialog associated with this option (user response is shown in **boldface type**):

```
Enter selection : 6
DECrepeater 90TS - slot 3
=====
          DELETE SNMP TRAP ADDRESSES
Format: The standard 4 octet dotted decimal notation in which
       each octet of the address is represented as a decimal
       value, separated by a '.' character.
       example: 16.20.40.156
=====
Configured SNMP Trap Addresses: 16.20.216.81
                               Trap address [] : 16.20.216.81 
                               Trap address deleted. Delete another? [] : 
                               Press Return for Main Menu ...
```

Enter the SNMP trap address that you have chosen for deletion, then press Return.

Appears only if the module has been previously configured.

Configuring the Module (Cont.)

[7] Dump Error Log

This option displays error log dumps for use by Digital support personnel when analyzing system faults. Up to four error log dumps can be stored, and the most recent dump is displayed first.

The following is an example of the display associated with this option:

```
Enter selection : 7
DECrepeater 90TS Slot 3
=====
DUMP ERROR LOG
CURRENT RESET COUNT: 14
=====
Entry #      = 3
Timestamp    = 0 0 791
Reset Count  = 13
Trap @315 in console_cfg.c Backplane clock failure
Dump another entry Y/[N]? N 
=====
No more Error Log entries.

Press Return for Main Menu ...
```

Configuring the Module (Cont.)

[8] Set In-Band Interface IP Address

This option prompts you to enter the module's IP address.

The format for an IP address is the standard 4-octet dotted decimal notation, where each octet of the address is represented as a decimal value, separated by a decimal point (.).

The following is an example of an IP address: 16.20.54.156

The following is an example of the dialog associated with this option (user response is shown in **boldface type**):

```
Enter selection : 8
DECrepeater 90TS - slot 3
=====
          SET IN-BAND INTERFACE IP ADDRESS
Format: The standard 4 octet dotted decimal notation in which
        each octet of the address is represented as a decimal
        value, separated by a '.' character.
        example: 16.20.40.156
To delete the IP address, enter 0 in the appropriate
address field.
-----
IP address [16.20.216.179] : 16.20.54.156 
          IP Address set
          Press Return for Main Menu ...
```

This cell data represents a previously set IP address. During the initial setup, this cell default appears as [].

Enter the module's IP address, then press Return.

Configuring the Module (Cont.)

[9] Set In-Band Interface Default Gateway Address

This option prompts you for a default gateway IP address. The default gateway address is needed only to deliver traps to a management station that is not on the local subnet.

NOTE: The module does **not** need to be configured with a subnet mask for SNMP communications with a management station that is located on any subnet in the IP network.

The following is an example of a default gateway IP address: 16.07.80.156

The following is an example of the dialog associated with this option (user response is shown in **boldface type**):

```
Enter selection : 9
DECrepeater 90TS - slot 3
=====
      SET IN-BAND INTERFACE DEFAULT GATEWAY ADDRESS
Format: The standard 4 octet dotted decimal notation in which
each octet of the address is represented as a decimal
value, separated by a '.' character.
      example: 16.20.40.156
To delete the IP address, enter 0 in the appropriate
address field.
=====
Default Gateway address [] : 16.07.80.156 
      Default Gateway Address set
      Press Return for Main Menu ...
```

Enter the module's default gateway IP address, then press Return.

Configuring the Module

[10] Downline Upgrade

This option allows you to upgrade the module firmware (in nonvolatile Flash memory). It prompts you to enter the firmware image load filename and the IP address of your Trivial File Transfer Protocol (TFTP) load host.

Before initiating this option, be sure that the module that you are updating has been configured with an IP address. If the module is not configured with an IP address, select the `Set In-Band Interface IP Address` option (option [8]) from the `DECrepeater 90TS INSTALLATION MENU` to set an IP address.

Do not use the DEChub 900 MultiSwitch Hub Manager's IP address to upgrade the DECrepeater 90TS.

NOTE: The module's IP address is retained at the completion of the downline upgrade.

The following is an example of an firmware image load filename and an IP address:

`detm1110.bin` and `16.20.54.156`

When the screen prompts you to `Enter the Load Filename`, do the following:

- If the file is located in the default TFTP directory, enter only the filename.
- If the file is **not** located in the default TFTP directory, enter the complete pathname along with the filename.

The format of the firmware image load filename is specified according to the conventions used by your TFTP load host.

CAUTION  If power is interrupted during Stage 3 of the DLU process, the firmware image can become corrupted. Do not turn off power to the unit or perform any action that can cause the unit to lose power during Stage 3 of the DLU process.

The Downline Upgrade (DLU) Process

The DLU process consists of four stages:

- Stage 1 — Transferring Firmware Image
- Stage 2 — Verifying Firmware Image
- Stage 3 — Writing New Firmware Image into Nonvolatile Storage
- Stage 4 — Module Reset and Self-Test

The following table explains what happens during each stage of the DLU process.

Configuring the Module

Table 1 DLU Process Description

Stage	What Happens
1	<p>The new firmware image from the TFTP load host is transported across the network, and placed into a temporary storage buffer in the module.</p> <p>Indications that this stage is in progress include:</p> <ul style="list-style-type: none">• Module status — functional, but not manageable.• Module cannot respond to management requests.• LED display — The Power[Ⓢ], Module OK[Ⓢ], and Network* LEDs remain on. The Port State LED #2 lights.• HUB Manager display — <code>DECrepeater 90TS</code> <code>unknown</code>• Typical time to complete this stage — normally 1 minute, however, due to variances in network configurations (load path, bit rate, and traffic levels), this stage of the DLU process can take up to 10 minutes to complete.



(continued on next page)

*If the module is connected to the network through the ThinWire port, the Network OK # A LED is lit. Otherwise, if the module is connected to the network through the AUI port, the Network OK # B is lit.

Configuring the Module (Cont.)

[10] Downline Upgrade (Cont.)

Table 1 (Cont.) DLU Process Description

Stage	What Happens
2	<p>The module verifies that the firmware image is correct after Stage 1 is complete.</p> <p>Indications that this stage is in progress include:</p> <ul style="list-style-type: none">• Module status — functional, but not manageable.• Module cannot respond to management requests.• LED display — The Power , Module OK , and Network* LEDs remain on. The Port State LED #2 turns off. The Port State LED #3 lights.• HUB Manager display — <code>DECrepeater 90TS</code> <code>unknown</code>• Typical time to complete this stage — normally 10 seconds.

(continued on next page)

*If the module is connected to the network through the ThinWire port, the Network OK # A LED is lit. Otherwise, if the module is connected to the network through the AUI port, the Network OK # B is lit.

Configuring the Module (Cont.)



[10] Downline Upgrade (Cont.)

Table 1 (Cont.) DLU Process Description

Stage	What Happens
3	The new firmware image is transferred from the module's temporary storage buffer to the Flash RAM, overwriting the old firmware image.

CAUTION  If power is interrupted during Stage 3 of the DLU process, the firmware image can become corrupted. Do not turn off power to the unit or perform any action that can cause the unit to lose power during Stage 3 of the DLU process.

Indications that this stage is in progress include:

- Module status — functional, but not manageable.
- Module cannot respond to management requests.
- LED display — The Power , Module OK , and Network* LEDs remain on. The Port State LED #3 turns off. The Port State LED #4 lights.
- HUB Manager display — `DECrepeater 90TS`
`unknown`
- Typical time to complete this stage — normally 30 seconds.

(continued on next page)

*If the module is connected to the network through the ThinWire port, the Network OK # A LED is lit. Otherwise, if the module is connected to the network through the AUI port, the Network OK # B is lit.

Configuring the Module (Cont.)

[10] Downline Upgrade (Cont.)

Table 1 (Cont.) DLU Process Description

Stage	What Happens
4	<p>The module resets, runs self-test, and then begins executing the new firmware image.</p> <p>Indications that this stage is in progress include:</p> <ul style="list-style-type: none"> • Module status — not functional during reset and self-test. • Module cannot respond to management requests. • LED display — The Power Ⓞ and Network* LEDs remain on. The Module OK Ⓞ and Port State LED #4 turn off. The Port State LEDs then cycle through various patterns. • HUB Manager display — <code>DECrepeater 90TS unknown</code> • Typical time to complete this stage — normally 1 minute. <p>After the successful completion of self-test, the Module OK Ⓞ LED turns on and the module becomes fully manageable. Note also that the HUB Manager display indicates: <code>DECrepeater 90TS up</code></p>

*If the module is connected to the network through the ThinWire port, the Network OK # A LED is lit. Otherwise, if the module is connected to the network through the AUI port, the Network OK # B is lit.

Configuring the Module (Cont.)

[10] Downline Upgrade (Cont.)

The following section explains how to use the DLU process. An expanded example of the setup screen display follows the description.

Using the DLU Process

Before initiating this option, be sure that the module that you are upgrading has been configured with an IP address. If the module is not configured with an IP address, select the Set In-Band Interface IP Address option (Option [8]) from the DECrepeater 90TS INSTALLATION MENU to set an IP address.

Do not use the DEChub 900 Multiswitch Hub Manager's IP address to upgrade the DECrepeater 90TS.

When you select the Downline Upgrade option (Option [10]) from the DECrepeater 90TS INSTALLATION MENU, the initial setup screen display appears (see the following example display). This screen identifies the option and alerts users not to interrupt power during the downline load.

```
Enter selection : 10
DECrepeater 90TS

=====
                        DOWNLINE UPGRADE

This process upgrades the device's firmware (in
nonvolatile Flash memory). Enter the IP address of
your TFTP (Trivial File Transfer Protocol) load host
and the image file name when prompted.

* * * * *
*      IMPORTANT!      IMPORTANT!      IMPORTANT!      *
* * * * *
* If power is interrupted during the downline load, the *
* firmware image can be corrupted. Do not turn off power *
* to the unit or perform any action that can cause the *
* unit to lose power during a downline upgrade.          *
* * * * *

=====

... Press Return Key to Continue ...
```

Configuring the Module (Cont.)

[10] Downline Upgrade (Cont.)

When you press , the screen prompts you to Enter the Load Filename. Do the following:

- If the file is located in the default TFTP directory, enter only the filename.
- If the file is **not** located in the default TFTP directory, enter the complete pathname along with the filename.

The following example shows the dialog associated with this option using a file that is located in the default directory (user response is shown in **boldface type**):

```
Enter the Load Filename [] detmi110.bin 
```

After you enter the firmware image filename and press , the screen prompts you to enter the IP address of the TFTP server (load host):

```
Enter the Load Host IP Address [] :16.20.54.156 
```

After you enter the load host IP address, the following screen and dialog appear:

```
Load will be initiated over the Ethernet Port network
interface.
The device becomes nonfunctional for up to 10 minutes
during the time that the flash load is in progress.
When the load is complete the screen displays the message:
(Device Not Responding!) This is normal.

... Press Return Key to Start Load [Ctrl/C to abort]...
```

NOTE: The DECrepeater 90TS is nonfunctional only during reset and self-test (about 1 minute of Stage 4) of the DLU process. During the first three stages of the process, the module continues to function as a repeater.

When you press , the DLU process is initiated over the Ethernet port network interface.

Configuring the Module (Cont.)

[10] Downline Upgrade (Cont.)

After you initiate the DLU process, the screen displays the following message:

```
DLU process started!
```

CAUTION  If power is interrupted during Stage 3 of the DLU process, the firmware image can become corrupted. Do not turn off power to the unit or perform any action that can cause the unit to lose power during Stage 3 of the DLU process.

NOTE: Because of variances in network configurations (load path and traffic levels), this initial stage of the DLU process can take up to 10 minutes to complete.

If your module is installed into a DEChub 90 or as a standalone unit, go to the section titled DLU Process Completion, on the following page.

If your module is installed into a DEChub 900, the screen displays the following message:

```
Module not responding! Connection closed!
```

This is normal.

The Hub Manager status display indicates the following:

Hub Manager Status Display

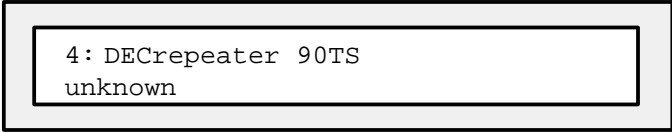

The Hub Manager status display continues to display this message until the DLU process is complete. This is normal.

Configuring the Module (Cont.)

[10] Downline Upgrade (Cont.)

DLU Process Completion

When the DLU process is complete, the module resets and initiates self-test. After self-test completes successfully, the module exits from the DLU process and begins the execution of the new firmware image. The Module OK  LED turns on and the module becomes fully operational.

The screen displays one of the following:

- If the module is installed into a DEChub 90 or as a standalone unit, the screen displays the DECrepeater 90TS INSTALLATION MENU.
- If the module is installed into a DEChub 900, the screen displays the following message:

```
Press Return for Main Menu ...
```

When you press , the screen displays the DECrepeater 90TS INSTALLATION MENU.

Configuring the Module (Cont.)

[10] Downline Upgrade (Cont.)

The following illustration shows an (expanded) example of the setup screen displays:

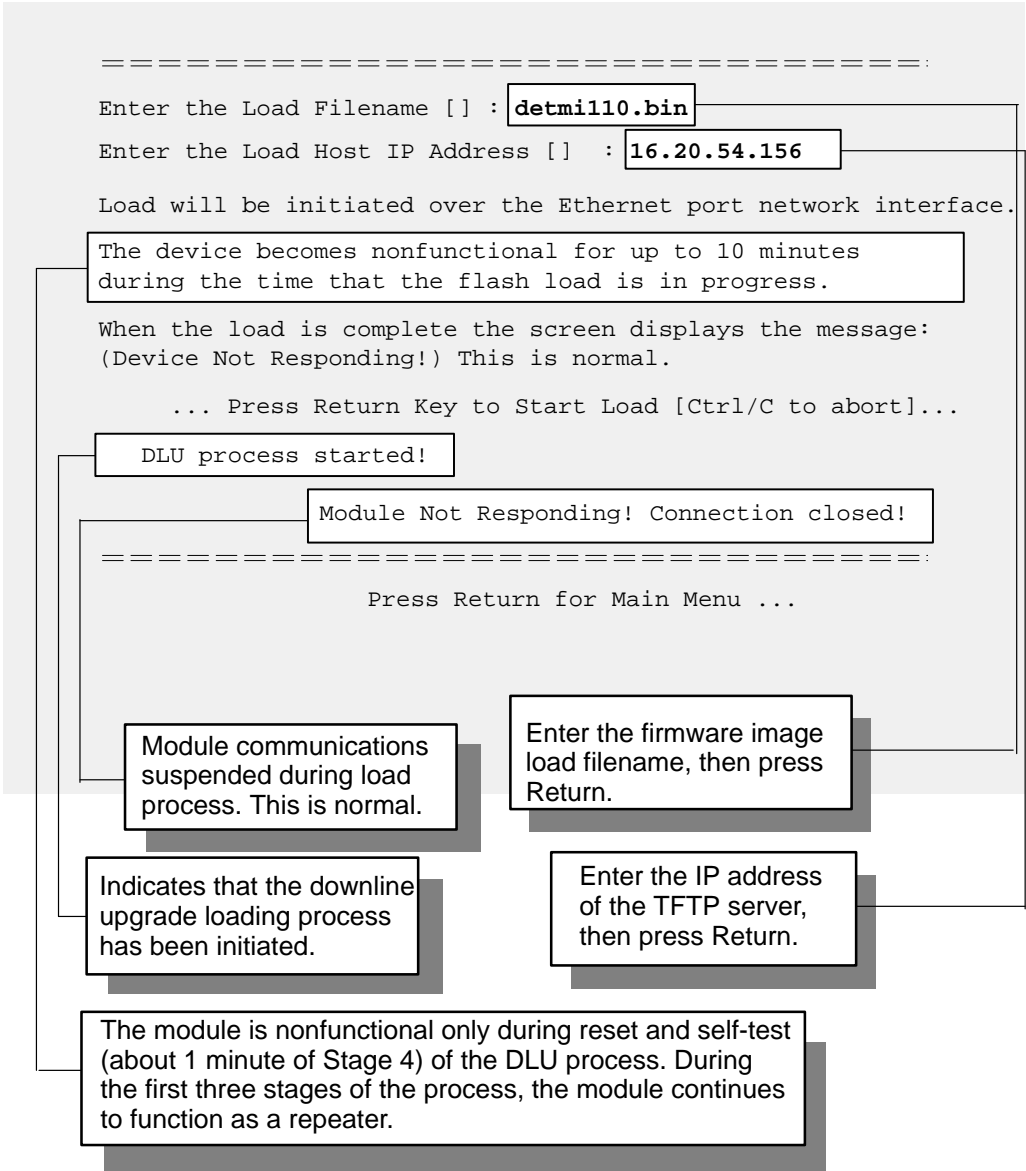

Configuring the Module (Cont.)

[11] Set Out-of-Band Management (OBM) Interface IP Address

NOTE: This selection is operational only when the module is installed into a DEChub 90 or as a standalone unit.

This option prompts you to enter the IP address of your out-of-band management interface.

This option allows you to manage your module through the front-panel serial port when the module is installed in a DEChub 90 or as a standalone unit. You can enable out-of-band management in addition to normal in-band management. To enable out-of-band management, you need to assign an OBM IP address (use Option [11]) and select an OBM port speed (use Option [12]) from the DECrepeater 90TS Installation Menu.

The following is an example of the dialog associated with this option (user response is shown in **boldface type**):

```
Enter selection : 11
DECrepeater 90TS
=====
SET OUT-OF-BAND MANAGEMENT (OBM) INTERFACE IP ADDRESS
Format: The standard 4 octet dotted decimal notation in which
       each octet of the address is represented as a decimal
       value, separated by a '.' character.

       example: 16.20.40.156

To delete the IP address, enter 0 in the appropriate
address field.

=====
IP address [ ] : 16.20.54.156 
Press Return for Main Menu ...
```

Enter the module's OBM IP address, then press Return.

Configuring the Module (Cont.)

[12] Set OBM Port Speed

NOTE: This selection is operational only when the module is installed into a DEChub 90 or in standalone mode.

This option prompts you to select and enter the speed of your out-of-band management port.

NOTE: The port speed at each end of the communications link must be identical.

The following is an example of the dialog associated with this option (user response is shown in **boldface type**):

```
Enter selection : 12
DECrepeater 90TS
=====
          SET OUT-OF-BAND (OBM) PORT SPEED
          [1] 1200 baud
          [2] 2400 baud
          [3] 4800 baud
          [4] 9600 baud
          [5] 19200 baud
          [6] 38400 baud
=====
Enter selection [2] (9600) : 2 
OBM port speed set.
Press Return for Main Menu ...
```

The OBM port speed you select must match the speed of your OBM port device.

NOTE: The front-panel serial port, when used for OBM, supports only 9,600 baud or higher speed modems.

Configuring the Module (Cont.)

[13] Module-Specific Options

NOTE: The Switch to OBM option from this submenu takes effect only when the module is installed into a DEChub 90 or in standalone mode.

This option provides module-specific selections. The sub-menu includes an option to switch to OBM. Other sub-menu items (not shown at this time) may be included in this option.

Switch to OBM

This selection allows you to switch from setup mode to OBM mode.

The following is an example of the dialog associated with this option (user response is shown in **boldface type**):

```
DECrepeater 90TS
=====
                DECrepeater 90TS Installation
                [1] SWITCH TO OBM
                [2] Return to Main Menu
=====

                Enter selection : 1 
                Press Y to confirm [N] : y 
                Press Return for Main Menu ...

Switching Console port to Out of Band Management mode
                Press Return for Main Menu ...
```

Configuring the Module (Cont.)

After selecting the option to switch to OBM mode, do the following:

1. Change the cable at either the front-panel serial port on the module or at the OBM device using one of the cable/adaptor pairs listed in the table below.
 - a. If the OBM device uses the **same** cable as the setup port device, disconnect the cable from the setup port device, and install it into the OBM device (see illustration).
 - b. If the OBM device uses a **different** cable than that used for the the setup port device, disconnect the cable from the front-panel serial port of the module, and connect the cable from the OBM device into the front-panel serial port of the module (see illustration on the next page).

Cable/Adapter Type	Connecting OBM Device
BN25G-xx ¹ /H8585-AC ²	A modem with a 25-pin D-Sub connector
BN25G-xx ¹ /8585-AA	A PC with a 9-pin D-Sub communications port
BN24H-xx ¹ /8584-AA	An 8-pin MJ terminal server

¹ xx indicates cable length in meters.

² Not for connection to public networks in Sweden, Germany, or Japan.

Configuring the Module (Cont.)

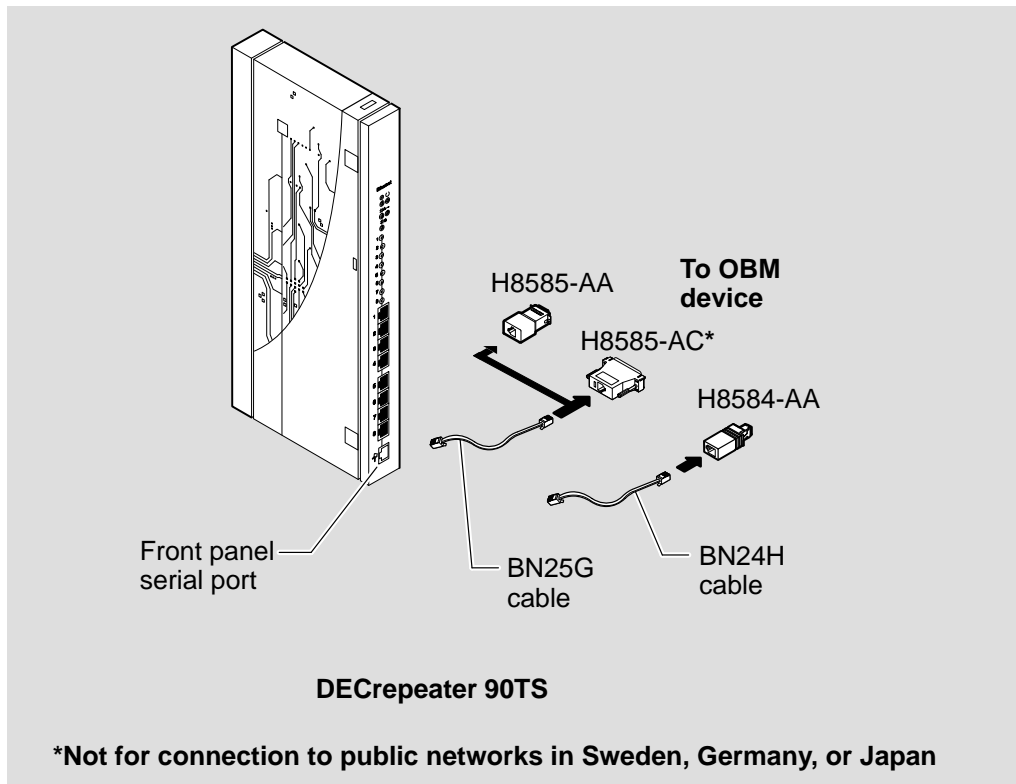

LKG-9150-941

2. To end OBM mode and return to setup mode, do the following:
 - a. Connect the cable from the front-panel serial port to a setup port device. (For more information, see the section titled Setup Port Device Cabling, on page 17.)
 - b. Recycle the power to the module.The setup port device displays the following message.

Type `ctrl-C` to end Out of Band Management mode.





- c. Press `Ctrl/C` on the setup port device within 30 seconds after the message is displayed on the setup port device to end the OBM session.

LED Descriptions

The module LEDs provide dynamic indications of module status. Flashing LEDs indicate special situations.

Table 2 shows the static states that are possible for each of the module LEDs.

Table 2 Module LED States

LED Name	Icon	Off	On	Flashing
Power		No power to module.	Module receiving power.	Faulty power connection or insufficient power.
Module OK		After 1 minute, self-test failed.	Module passed self-test.	N/A.
Network OK		ThinWire 10Base 2 port is not connected to a properly terminated and operational LAN, or the port is not selected.	ThinWire 10Base 2 port is connected to a properly terminated and operational LAN.	ThinWire 10Base2 port is disabled by network management.
Network OK		AUI port is not connected to a properly terminated and operational LAN, or the port is not selected.	AUI port is connected to a properly terminated and operational LAN.	AUI port is disabled by network management.
Network Activity		No network activity.	There is heavy traffic on the network.	Flashes more rapidly and appears brighter as network traffic increases.
Port State	1 through 8	Associated port is not connected to another operational network device, or there is a faulty cable.	Associated port is connected to another operational network device.	Associated port is disabled by network management.

Problem Solving Using the LEDs

When diagnosing a problem with the module, note that the problem is often indicated by the states of the module LEDs. Table 3 lists the states of the LEDs for various error conditions that can occur during initial installation of the device, along with probable causes and corrective actions to take.

Normal Powerup

When power to the module is initially turned on, the following events occur:



1. The Power  LED lights and stays lit.
2. The module initiates its built-in self-test. During self-test, the Port State LEDs cycle through various patterns.
3. After the successful completion of self-test (within 30 seconds), the Module OK  LED lights, and remains lit.
4. The remaining LEDs indicate their operational status, as described in Table 3.



Table 3 Problem Solving Using the LEDs

Symptom	Probable Cause	Corrective Action
All LEDs are off	The module does not have power.	If the module is installed as a standalone unit: Secure the power cables at the back cover and between the power supply and the wall outlet. Check the wall outlet using another appliance or light, or plug the power cord into another outlet. If no power is available, check the wall outlet's circuit breaker. If the problem persists, replace the power supply or the module.

(continued on next page)

Problem Solving Using the LEDs (Cont.)

Table 2 (Cont.) Problem Solving Using the LEDs

Symptom	Probable Cause	Corrective Action
All LEDs are off (cont.)	The module does not have power.	<p>If the module is installed in either the DEChub 900 or the DEChub 90:</p> <p>Reseat the module.</p> <p>Remove the module and inspect the module's 48-pin connector for bent, broken, or dirty pins. If no pins are broken or bent, reinstall the module.</p> <p>If the problem persists, replace module.</p>
Power  LED is off.	Bad power LED.	Replace the module.
Module OK  LED is off.	<p>Self-test is in progress.</p> <p>Self-test failed.</p>	<p>Wait for self-test to complete.</p> <p>If the LED does not light after 1 minute, reseat the module to repeat the self-test. If self-test fails again, replace the module.</p>
Port State LED is off.	Improper cable connection.	Check that the cables and connections are installed properly.
Port State LED is flashing.	Associated port is disabled by network management.	Enable the associated port, if necessary.

Connector Pin Assignments

AUI (15-pin D-Sub) Port Connector

The following illustration shows a 15-pin AUI connector and its pin assignments:

Pin	Ports	Pin	Ports	Pin	Ports
1	Ground	6	Power rtn	11	Ground
2	CI+	7	NC	12	DI-
3	DO+	8	Ground	13	Power (12V)
4	Ground	9	CI-	14	Ground
5	DI+	10	DO-	15	NC

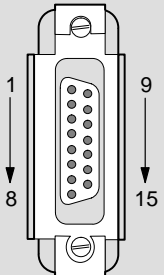

15-pin AUI connector

LKG-8866-93I

Serial Port (8-pin MJ) Connector

The following illustration shows the front panel serial port 8-pin MJ connector and its pin assignments:

Pin	Assignment
1	GND
2	RX
3	GND
4	CTS
5	RTS
6	TX
7	DTR
8	DSR

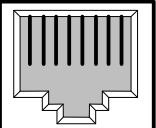

8-pin MJ connector

LKG-9237-94

Connector Pin Assignments (Cont.)

10BaseT Port (8-pin MJ) Connector

The following illustration shows the 10BaseT port (8-pin MJ) crossover connector and its pin assignments:

Pin	Assignment
1	RX+
2	RX-
3	TX+
4	Unused
5	Unused
6	TX-
7	Unused
8	Unused

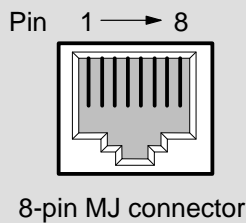

8-pin MJ connector

LKG-9552-941

H8585-AC Adapter

The following illustration shows the H8585-AC adapter (8-pin MJ to 25-pin connector) and its pin assignments:

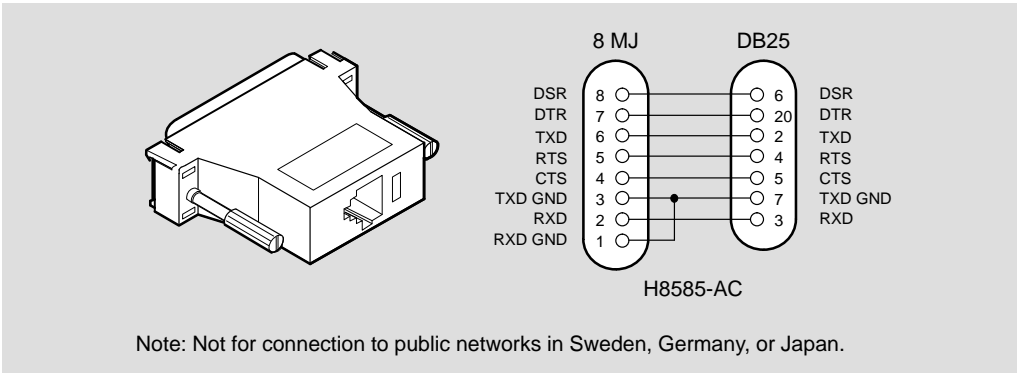

Note: Not for connection to public networks in Sweden, Germany, or Japan.

LKG-6975-921

Connector Pin Assignments (Cont.)

H8571-J Adapter

The following illustration shows the H8571-J adapter (6-pin MMJ to 9-pin D-Sub connector) and its pin assignments:

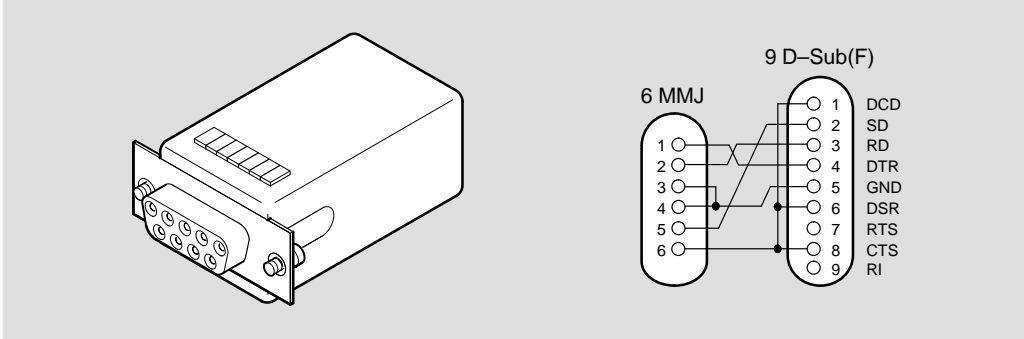

LKG-5342-911

H8575-A Adapter

The following illustration shows the H8575-A adapter (6-pin MMJ to 25-pin D-Sub connector) and its pin assignments:

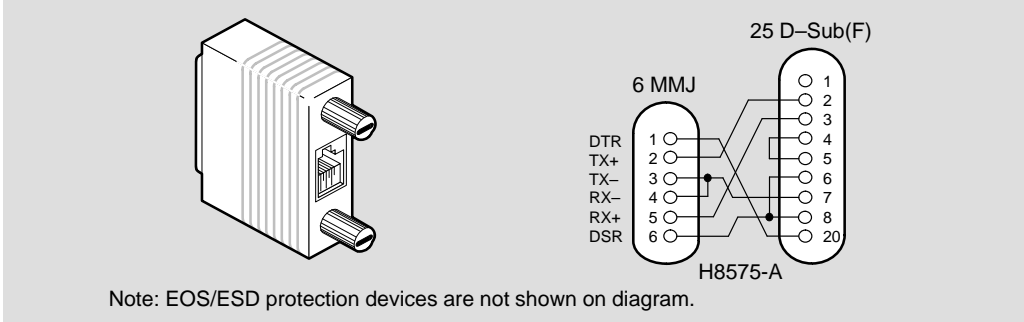

Note: EOS/ESD protection devices are not shown on diagram.

LKG-8793-931

Connector Pin Assignments (Cont.)

H8584-AA Adapter

The following illustration shows the H8584-AA adapter (8-pin MP to 6-pin MJ connector) and its pin assignments:

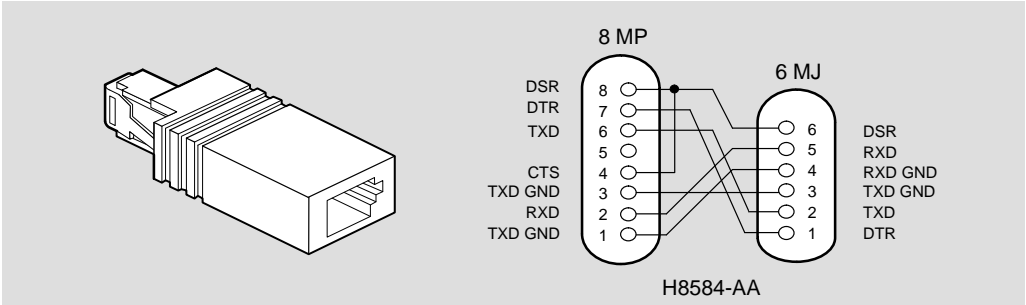

LKG-6972-921

H8585-AA Adapter

The following illustration shows the H8585-AA adapter (8-pin MJ to 9-pin DB connector) and its pin assignments:

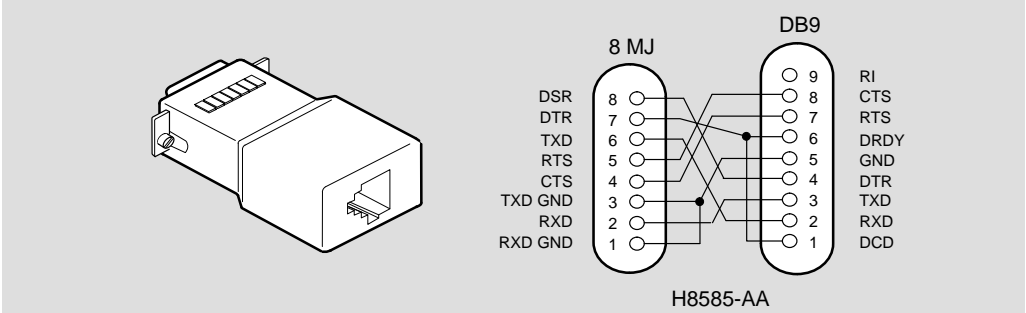

LKG-6973-921

Connector Pin Assignments (Cont.)

Internal and External Crossover Configurations

A crossover function must be implemented in every twisted-pair link. The crossover function (internal or external) allows the transmitter of one device to connect to the receiver of the device at the other end of the twisted-pair link.

The following illustrations show the use of straight-through and crossover cables for connecting internal and external crossover-type devices. The DECrepeater 90TS uses crossover connectors.

Internal Crossover Configuration

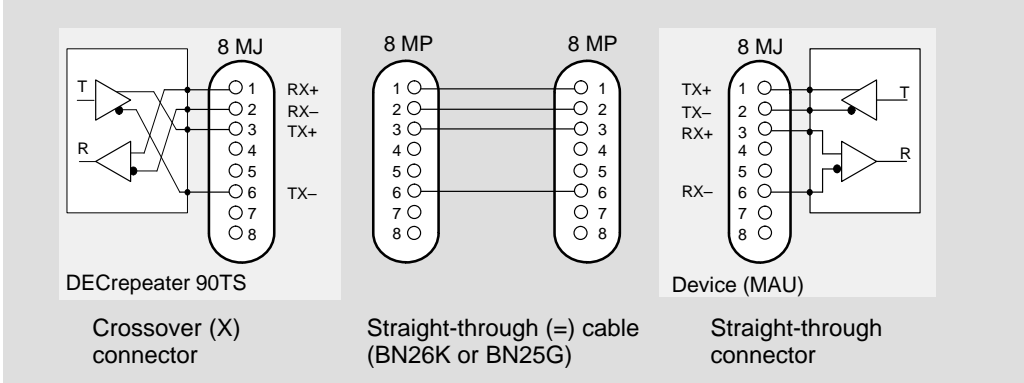

LKG-9153-941

External Crossover Configuration

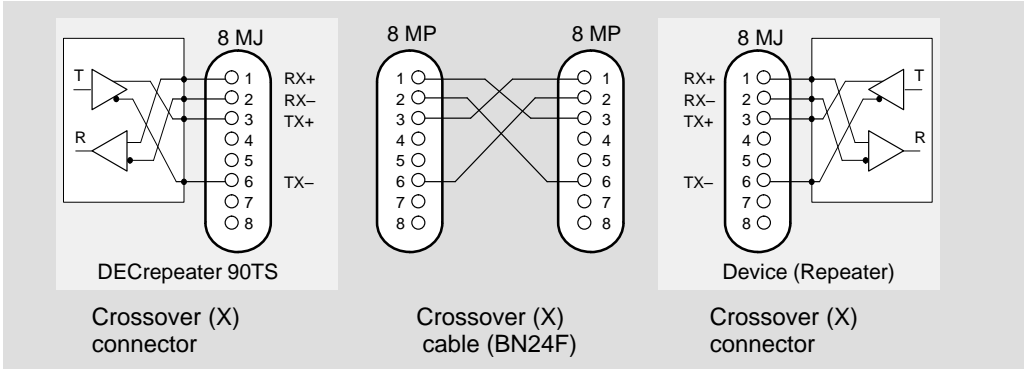

LKG-9342-941

Product Specifications

Table 4 lists the DECrepeater 90TS physical, environmental, and certification specifications. Note the additional parameters (listed in the table) to consider when the module is installed as a standalone unit.

Table 4 DECrepeater 90TS Operating Specifications

Parameter	Specification
Operating Environment	
Operating Temperature ¹	5° C to 50° C (41° F to 122° F)
Relative Humidity	10% to 95% noncondensing
Altitude	Sea level to 4900 m (16,000 ft)
Power – in a DEChub 900	6.0 W, total power 1.2 A, 5Vdc, 0.0 A, 12Vdc 0.0 A, 15Vdc
Power – in a standalone with the back cover installed	12.0 W, total power 1.2 A, 5Vdc 0.5 A, 12Vdc (when connected to the network by means of the AUI connector)
Connectors	
1 AUI (15-pin D-Sub)	
9 MJ-8 (eight 8-pin MJ 10BaseT connectors, one 8-pin MJ serial port connector)	
Physical	
Height	27.3 cm (10.75 in)
Width	3.2 cm (1.25 in)
Depth	11.2 cm (4.4 in); 13.5 cm (5.3 in) when installed as a standalone unit.
Weight	0.82 kg (1.5lb); 1.09 kg (2.0 lb) when installed as a standalone unit.
Certification	
CE, CSA, FCC, TÜV, UL, VCCI	

¹ For sites above 4900 m (16,000 ft), decrease the operating temperature specification by 1.8° C for each 1000 m or 3.2°F for each 3200 ft.

Product Specifications (Cont.)

Table 5 lists the acoustical specifications for the DECrepeater 90TS

Table 5 Acoustical Specifications

Acoustics — Declared values per ISO 9296 and ISO 7779¹

Product	Sound Power Level	Sound Pressure Level
	$L_{WA,d}$, B	L_{pAm} , dBA (bystander positions)
	<i>Idle/Operate</i>	<i>Idle/Operate</i>
DETM1	No acoustic noise	No acoustic noise
DETM1 + H7827-BA	No acoustic noise	No acoustic noise

Schallemissionswerte — Werteangaben nach ISO 9296 und ISO 7779/DIN EN27779²

Produkt	Schalleistungspegel	Schalldruckpegel
	$L_{WA,d}$, B	L_{pAm} , dBA (Zuschauerpositionen)
	<i>Leerlauf/Betrieb</i>	<i>Leerlauf/Betrieb</i>
DETM1	keine meßbaren Schallemissionen	keine meßbaren Schallemissionen
DETM1 + H7827-BA	keine meßbaren Schallemissionen	keine meßbaren Schallemissionen

¹ Current values for specific configurations are available from Digital Equipment Corporation representatives. 1 B = 10 dBA.

² Aktuelle Werte für spezielle Ausrüstungsstufen sind über die Digital Equipment Vertretungen erhältlich. 1 B = 10 dBA.

Associated Documents

The following documents provide related information about the module. Ordering information is provided at the back of this manual.

Title and Order Number	Description
<i>DEChub 900 MultiSwitch Owner's Manual</i> EK-DH2MS-OM	Provides installation, use, security, and troubleshooting information.
<i>HUBwatch Installation and Configuration</i> AA-Q0FXB-TE	Provides information for installing and configuring HUBwatch for Windows V2.0.
<i>HUBwatch Use</i> AA-PW4BC-TE	Provides network management and DEChub 900, DEChub 90 and DEChub ONE functionality information for HUBwatch for Open VMS V3.0.
<i>DEChub 90 Owner's Manual</i> EK-DEHUB-OM	Provides installation, use, security, and troubleshooting information.
<i>Using DECndu Plus (MS-DOS)</i> AA-PYVVA-TE	Provides instructions to upgrade the firmware in an MS-DOS environment in selected network devices using Digital's Network Device Upgrade (DECndu) Plus utility.
<i>Using DECndu Plus (ULTRIX RISC)</i> AA-PYVTA-TE	Provides instructions to upgrade the firmware in an ULTRIX RISC environment in selected network devices using Digital's Network Device Upgrade (DECndu) Plus utility.
<i>Using DECndu Plus (OPENVMS VAX)</i> AA-PYVRA-TE	Provides instructions to upgrade the firmware in an OPEN VMS VAX environment in selected network devices using Digital's Network Device Upgrade (DECndu) Plus utility.
<i>OPEN DECconnect Applications Guide</i> EC-G2570-42	Contains general descriptions to help plan and install networking systems based on Digital Equipment Corporation's OPEN DECconnect system and networking products.

HOW TO ORDER ADDITIONAL DOCUMENTATION

DIRECT TELEPHONE ORDERS

In Continental USA
call 1-800-DIGITAL
(1-800-344-4825)

In Canada
call 1-800-267-6215

In New Hampshire,
Alaska or Hawaii
call 1-603-884-6660

ELECTRONIC ORDERS (U.S. ONLY)

Dial 1-800-dec-demo with any VT100 or VT200
compatible terminal and a 1200 baud modem.
If you need assistance, call 1-800-DIGITAL (1-800-344-4825)

DIRECT MAIL ORDERS (U.S. and Puerto Rico*)

DIGITAL EQUIPMENT CORPORATION
P.O. Box CS2008
Nashua, New Hampshire 03061

DIRECT MAIL ORDERS (Canada)

DIGITAL EQUIPMENT OF CANADA LTD.
940 Belfast Road
Ottawa, Ontario, Canada K1G 4C2
Attn: A&SG Business Manager

INTERNATIONAL

DIGITAL EQUIPMENT CORPORATION
A&SG Business Manager
c/o Digital's local subsidiary
or approved distributor

Internal orders should be placed through U.S. Software Supply Business (SSB),
Digital Equipment Corporation, 10 Cotton Rd. Nashua, NH. 03063-1260

*Any prepaid order from Puerto Rico must be placed
with the Local Digital Subsidiary:
809-754-7575

DECrepeater 90TS Installation and Configuration
EK-DETM-I-IN. A01

Please return this card.

Your comments and suggestions will help us improve the quality and usefulness of our documentation.

Did you use the manual as a reference or as a step-by-step procedure to install the device?

Were the instructions easy to follow? _____

Were the instructions complete? _____

Were they in the proper sequence? _____

Which chapters or sections were most helpful? _____

Did you use the appendixes? Which ones? _____

Were the illustrations helpful? _____ All? _____ Some? _____ Which ones? _____

Were some illustrations unnecessary? _____ Which ones? _____

Do you think the manual needs more illustrations? _____ Please give an example. _____

Thank you.

Name _____ Date _____

Title _____ Department _____

Organization _____ Street _____

City _____ State/Country _____ Zip Code _____

DO NOT CUT – FOLD HERE AND TAPE

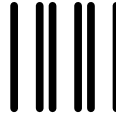

NO POSTAGE
NECESSARY
IF MAILED
IN THE
UNITED STATES

BUSINESS REPLY LABEL

FIRST CLASS PERMIT NO. 33 MAYNARD MASS.

POSTAGE WILL BE PAID BY ADDRESSEE

digital[™]

Information Design and Consulting
550 King Street, LKG1-3/L12
Littleton, MA 01460-1289

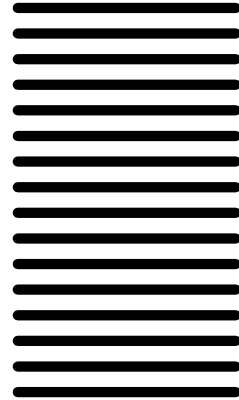

DO NOT CUT – FOLD HERE