

# DEC WANcontroller 618



## Problem Solving

Part Number: EK-A0546-PS.001

© Digital Equipment Corporation. 1992. All Rights Reserved.

## DEC Network Integration Server Problem Solving

### DECNIS Problem Solving Manuals

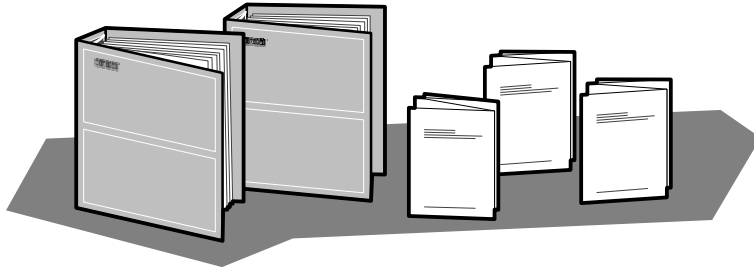

*DEC Network Integration Server Problem Solving:* outlines NCL commands for checking software problems.

*DECNIS Installation and Service Manual:* includes a problem solving section which outlines procedures for checking hardware problems.

*Network Interface Card (NIC) Problem Solving cards:* are supplied with each NIC. The cards outline procedures for checking possible problems with NICs, their cables, distribution panels and modems. Start problem solving with the flowchart.



*DEC Network Integration Server Event Messages:* this is an on-line text file. The file lists event messages that can indicate faults with hardware and software. The event message describes the meaning of each event and what action to take.

### BT Kilostream®

There is no loopback test for the BT Kilostream cable. To check if these cables are faulty, you must replace them and retest the line. If you are unable to solve your problem, contact Digital Services.

### Loopback Connectors





Loopback Connector	Part Number	Component
50-way loopback connector (male)	DNSXT-CA	NIC and connecting cable
V.28, EIA-232D	H3248	Distribution panel
V.36/V.11, EIA-422	H3198	and extension cable
V.35	H3250	

® Kilostream is a registered trademark of British Telecommunications, plc.

LKG-5721-911

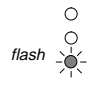
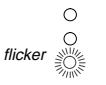
## NIC LED States

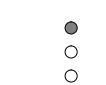
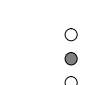
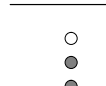
The LED display shows the state of the NIC when the module self-test or system self-test was last run: see the *Installation and Service Manual* for your DECNIS for more details.

	Slow flash	Module self-test in progress.
	Fast flicker	The NIC is either waiting to load or is loading software.
	READY	The NIC has passed its module self-test and has successfully loaded the software.
	HOTSWAP	The NIC is disabled. (The NIC switch is set down.)
	FAULT	The NIC has failed its module self-test.
	ATTENTION	The NIC is partly working. You can continue to use working port(s), but you must isolate and replace the faulty component as soon as possible.
	<p>A flickering RUN LED indicates that the NIC software is waiting to load.</p>	

LKG-5722-911

## Problem Solving Flowchart – note the NIC LED state and follow the procedure indicated

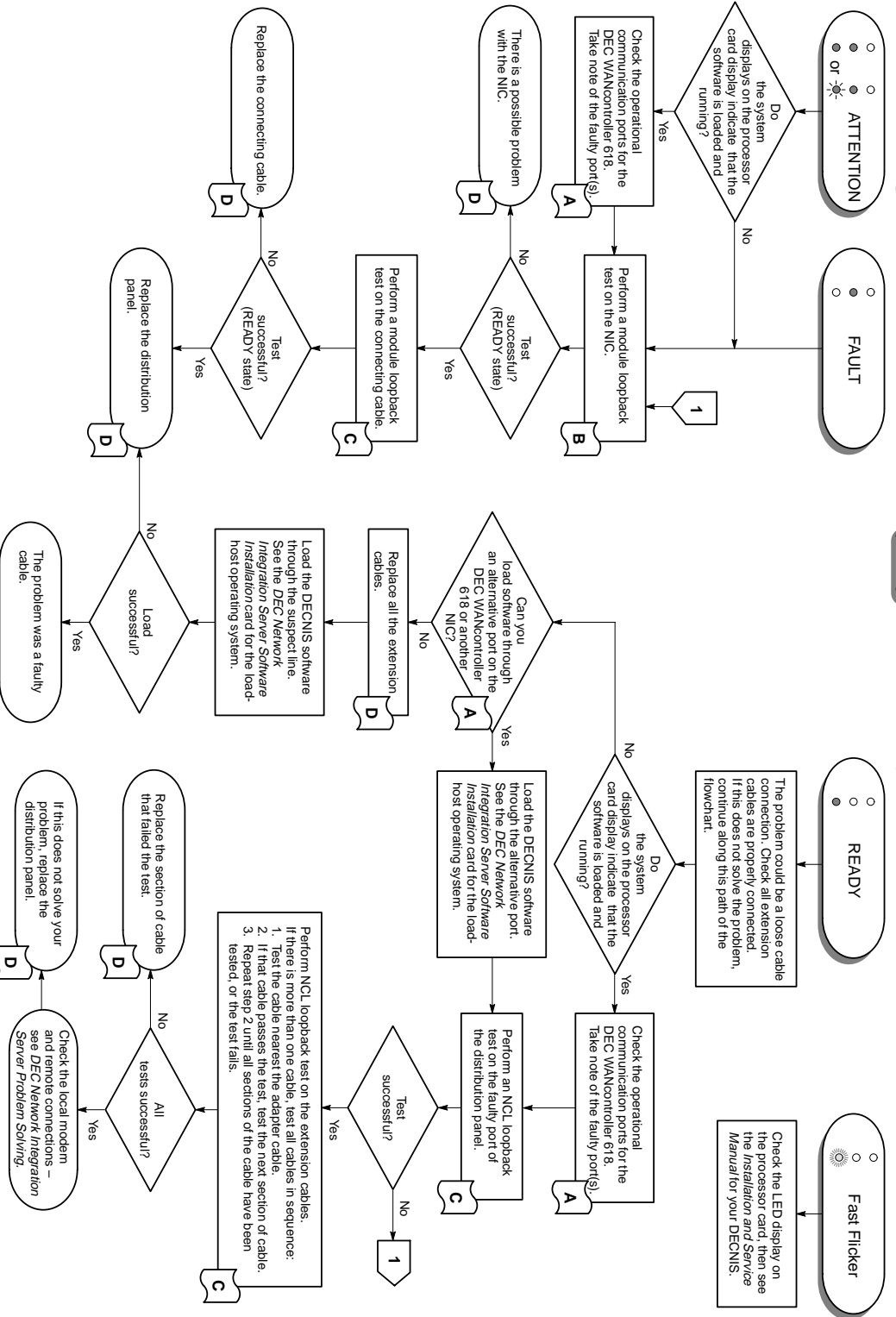

For details of tests and procedures, refer to the panel with the matching flag (see overleaf).

LKG-5726-61

## A Checking the Operational Communication Ports

1. Start NCL on the load host.

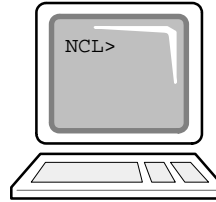

2. Enter the following command:

```
NCL> SHOW NODE server DEVICE UNIT unit-name -  
_NCL> ALL STATUS
```

where *server* and *unit-name* are the names for the DECNIS and DEC WANcontroller 618, respectively.

3. Find the attribute “operational communication ports”. This lists the working ports by device name, where:

Device name for the DEC WAN-controller 618 — W618-3-5 — Port number  
Slot number

For example, if port 5 is faulty, the display reads:

```
Operational communication ports = {W618-3-0,  
W618-3-1, W618-3-2, W618-3-3, W618-3-4, W618-3-6,  
W618-3-7}
```

4. The working ports, or lines, can still be used. You can continue using the NIC if necessary, but it is best to isolate and replace the faulty component as soon as possible. To do this, follow the procedures indicated for the ATTENTION state on the problem solving flowchart.

## B Module Loopback Test

1. Disable the NIC – move the NIC switch down.

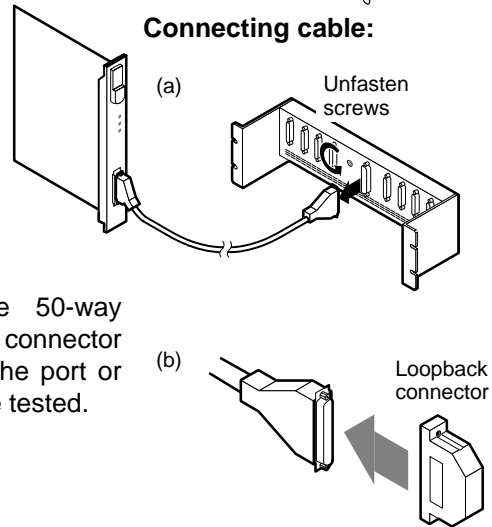
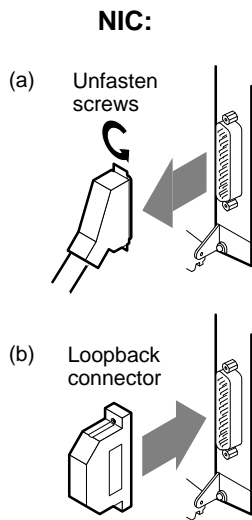
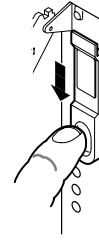

2. Attach the 50-way loopback connector (male) to the port or cable to be tested.

3. Run the module loopback test:

1. Move the NIC switch up.
2. Wait until READY LED stops flashing (max. 2 min)
3. Observe the test result on the LED display.

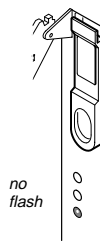
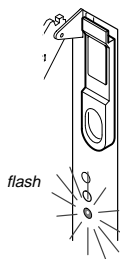
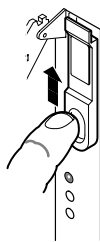

**NOTE**  
If loading has been disabled for this slot, the READY LED will not stop flashing. To enable the slot, see the manual *DEC Network Integration Server Management*.

4. If the test passes, the LEDs show the RUN state.  
If the test fails, the LEDs show the FAULT or ATTENTION state.
5. Disable the NIC. Reconnect the connecting cable if you have to perform more testing.

LKG-5723-911

## C NCL Loopback Test

1. Start NCL on the load host.



### Distribution panel port:

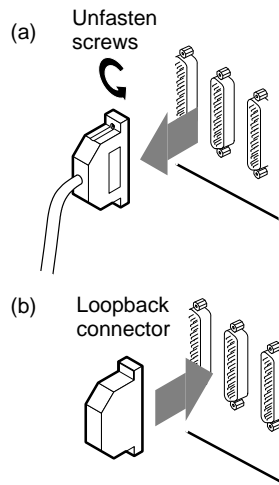

2. Attach the cable loopback connector to the port or cable to be tested.

### Synchronous cable:

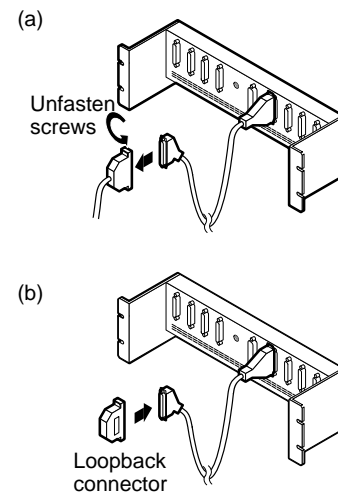

3. Enter the following command at the NCL prompt:

```
NCL> STARTLOOP NODE server MODEM CONNECT LINE -  
_NCL> line-name MODE CONNECTOR
```

When the prompt returns, enter the following command:

```
NCL> LOOP NODE server MOP CIRCUIT circuit [COUNT -  
_NCL> integer,] [LENGTH integer,] [DATA type]
```

#### NCL Command Information

*server* = server name  
*line-name* = name of physical line  
*circuit* = circuit name

COUNT, LENGTH, and DATA specify the number of blocks, length, and type of data to be sent in the test. The default sends 1 block of 40 bytes with an alternating sequence of 1s and 0s (hexadecimal value=55). For more details, see *DEC Network Integration Server Problem Solving*.

4. If the test passes, no message is displayed.  
If the test fails, an error message is displayed.

## Replacing Faulty Components

---

Faulty Components	Action
NIC	Install a new NIC. Refer to the <i>Installation and Service Manual</i> for your DECNIS: DO NOT do this unless you are a service person.
Distribution panel Connecting cable	Refer to the panel for installing the distribution panel and connecting cable in the <i>DEC WANcontroller 618 Cabling Information and Specifications</i> card. Before replacing these components, you <b>MUST</b> disable the NIC.
Extension cable	Refer to the panel for attaching communication cables in the <i>DEC WANcontroller 618 Cabling Information and Specifications</i> card.

---

**If replacing the faulty component does not solve the problem,** check the *Installation and Service Manual* for your DECNIS: do not perform any procedures in the manual unless you are a service person (see the *Installation and Service Manual* for your DECNIS).

---